

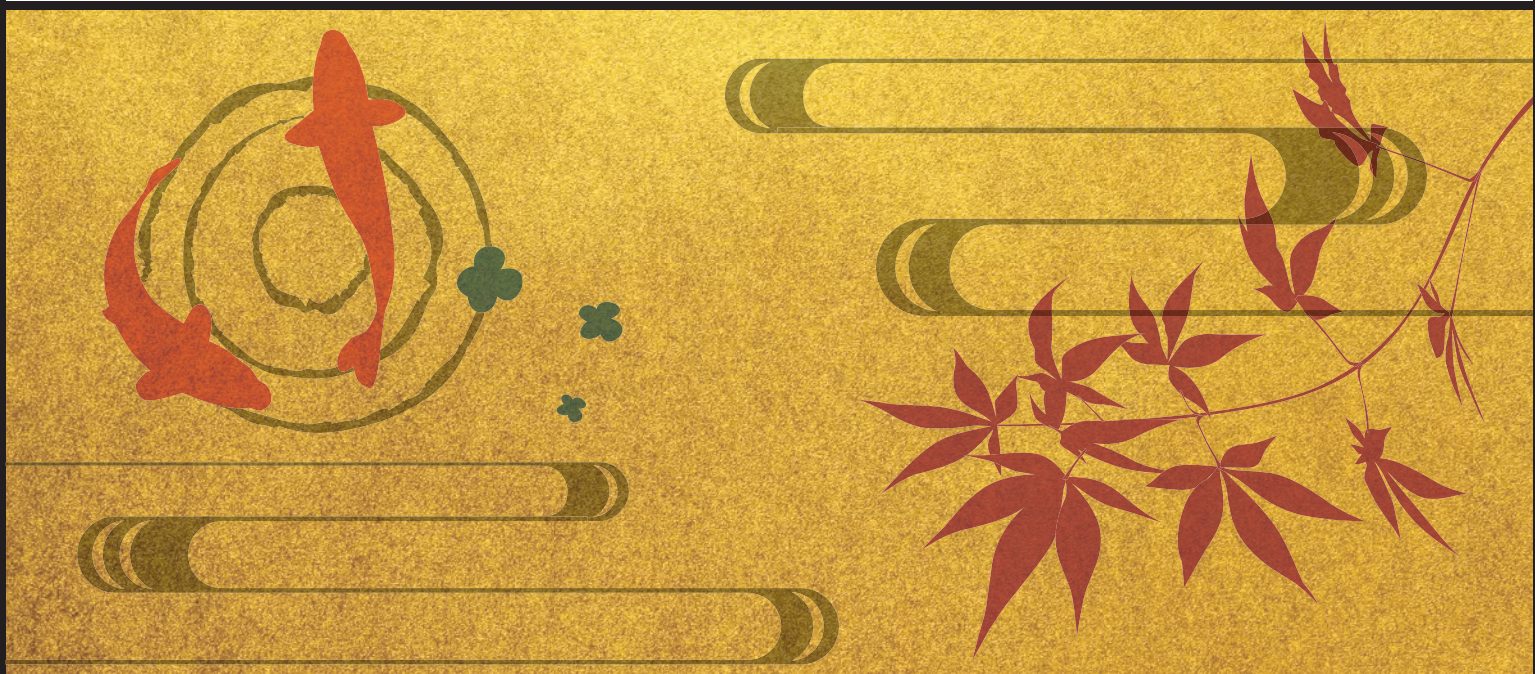

The 22nd
INTERNATIONAL CONFERENCE ON
COMPUTERS IN EDUCATION

Main Conference Proceedings

— NOV 30 - DEC 4, 2014 NARA, JAPAN —



**Proceedings of the
22_{nd} International Conference
on Computers in Education
ICCE 2014**

November 30, 2014 - December 4, 2014

Nara, Japan

Copyright 2014 Asia-Pacific Society for Computers in Education

All rights reserved. No part of this book may be reproduced, stored in a retrieval system, transmitted, in any forms or any means, without the prior permission of the Asia-Pacific Society for Computers in Education.

ISBN 978-4-9908014-1-0

Publisher

ICCE 2014 Organizing Committee, Japan

ICT Unit, Center for Graduate Education Initiative, Japan Advanced Institute of Science and Technology

1-1, Asahidai, Nomi, Ishikawa, 923-1292, Japan

Editors

Chen-Chung LIU
Hiroaki OGATA
Siu Cheung KONG
Akihiro KASHIHARA

Associate Editors
(in alphabetical order)

Ching-Sing CHAI
Maiga CHANG
Wenli CHEN
Clark CHINN
Ulrike CRESS
Regine HAMPEL
Yusuke HAYASHI
Jack HSU
Marc JANSEN
Morris S. Y. JONG
KINSHUK
Rita KUO
Yu-Ju LAN
Lara LOMICKA-ANDERSON
Jon MASON
Yukihiro MATSUBARA
Yongwu MIAO
Jun OSHIMA
Robby ROBSON
Hsin-Yih SHYU
Julita VASSILEVA
Barbara WASSON
Amali WEERASINGHE
Ying-Tien WU
Masanori YAMADA
Chengjiu YIN
Jianwei ZHANG
Li ZHANG

1. MESSAGES

Message from the Conference Chair

We would like to extend our warmest welcome to all participants of the 22nd International Conference on Computers in Education (ICCE) 2014. This year, the conference is held in Nara, a beautiful city at the center of Japan and an important hub of Japanese traditional culture. Building on the continuous success of the conference series in recent two decades, the program aims to foster vibrant exchanges and dynamic collaborations among the academic and research communities of technology enhanced learning around the world.

We are pleased to have outstanding scholars as conference speakers to share their insights across varying areas in the field of computers in education. As for the three keynote speeches, Marlene Scardamalia will discuss the designs for principle-based innovation in education; Yvonne Rogers will talk about how new technology can change learning for the better; and Kurt Squire will highlight the research and development on integrating digital games into science learning for fostering authentic participation among learners. For the three theme-based invited speeches, Yasuhisa Tamura will introduce the trends and standardization of digital textbooks; Yu-Ju Lan will discuss the unique features of virtual worlds in supporting learners in second language acquisition; and Huang-Yao Hong will talk about the ways of cultivating teaching professionals with the design thinking in teaching with technology. In addition, Noriko H. Arai will give a distinguished invited speech on sharing the experience of universities in Japan of using an AI system for supporting university entrance examinations; and Miguel Nussbaum will give a special invited speech on discussing the use of technology for scaffolding learners to develop critical thinking skills in the classroom learning process. We look forward to these informative and illuminating speeches for inspiring us to sharpen the synergy among technology, pedagogy and education.

The organization of such the large-scale conference of ICCE 2014 requires the concerted efforts and unfailing supports from our conference organization team members and conference paper reviewers, with their names enlisted in the proceedings. We would like to express our sincere gratitude to all the kind individuals who have rendered their help in every possible way to make this conference a reality. We would also like to thank all the paper authors and registered participants for their exciting academic contributions to the fruitful intellectual exchange in this conference.

We hope all participants will have further opportunities to create new friendships and professional collaborations, and to leave fond memories for their stays in Nara. With the breathtaking scenery and historic culture in Nara city, as well as the intellectual sharing and social bonding in conference program, it will definitely be a unique ICCE experience for everyone.

Thank you!
“Arigatou!”



Siu Cheung KONG
Conference Chair
(Hong Kong)

Message from Local Organizing Committee Chairs

It is a great pleasure to welcome you to the 22nd International Conference on Computers in Education (ICCE2014). ICCE2014 is held in Nara, Japan. Nara has over 1300 years of history. The first capital of Japan was built in Nara, "Heijokyo". Nara is the starting place of Japanese cultures and spirits. There are many historical sites including UNESCO's World Heritage in the city of Nara. We are very honored to hold ICCE2014 in the wonderful place.

ICCE2014 takes place in the Nara Prefectural New Public Hall. The hall is located in Nara National Park, which is surrounded by the famous historical shrine (Kasuga Taisha) and temple (Todaiji) registered as World Heritage sites. We hope that all participants enjoy not only the conference but also the beautiful city of Nara.

The conference series of ICCE is organized by APSCE. In ICCE2014, we worked particularly with the executive committee of APSCE. We greatly benefited from their valuable advice. ICCE2014 is also hosted by Japanese Society of Information and Systems in Education (JSiSE), Japan Society for Educational Technology (JSET), and Japanese Association for Education of Information Studies (JAEIS). We deeply thank the sincere support from these societies.

In addition, we would like to warmly acknowledge the financial support of sponsors: KANSAI-OSAKA 21st Century Association; KDDI Foundation; Support Center for Advanced Telecommunications Technology Research, Foundation; The Telecommunications Advancement Foundation; Tateisi Science and Technology Foundation; Nara Visitors Bureau. We would also like to thank cooperate sponsors for their financial support: UCHIDA YOKO Co., LTD. and Epson Sales Japan Corp. (at the Platinum level); DATA PACIFIC (JAPAN) LTD., PHOTRON LIMITED, Asahi Net, Inc., and Fujitsu Limited (at the gold level); Pro-Seeds Co., Ltd (at the silver level). Without the support from these sponsors, this conference would not have been a success. We are deeply thankful to the many student volunteers and staff volunteers from a lot of universities in Japan.

Finally, we cordially welcome all of you to Nara, Japan. We believe your participation and contribution to ICCE2014 will make it much more productive and successful. We also hope that you enjoy the conference and Japan to gain wonderful experience.

November 2014



Akihiro Kashihara
The Local Organizing Committee Chair
(Japan)

Message from the Program Coordination Chairs

The International Conference on Computers in Education (ICCE) is a series of annual conferences encompassing a broad range of issues related to using information technology for education, organized and sponsored by the Asia-Pacific Society for Computers in Education (APSCE). This year, ICCE 2014 is taking place in Nara, Japan from 30 November to 4 December 2014. Following the tradition of previous conferences in this series, ICCE 2014 is structured as a meta-conference that allows researchers from all over the world to connect with each other, to disseminate and share research, and to develop and deploy ideas that span the field of Computers in Education. There are seven interrelated sub-conferences focusing on specialized themes, each of which is organized by a program committee appointed by the respective special interest group (SIG – see http://www.apsce.net/sigs_list.php?id=1026), constitute the five-day Conference schedule. They are:

- C1:** ICCE Conference on Artificial Intelligence in Education/Intelligent Tutoring System (AIED/ITS) and Adaptive Learning
- C2:** ICCE Conference on Computer-supported Collaborative Learning (CSCL) and Learning Sciences
- C3:** ICCE Conference on Advanced Learning Technologies, Open Contents, and Standards
- C4:** ICCE Conference on Classroom, Ubiquitous, and Mobile Technologies Enhanced Learning (CUMTEL)
- C5:** ICCE Conference on Digital Game and Digital Toy Enhanced Learning and Society (GTEL&S)
- C6:** ICCE Conference on Technology Enhanced Language Learning (TELL)
- C7:** ICCE Conference on Practice-driven Research, Teacher Professional Development and Policy of ICT in Education (PTP)

The Program Committee is comprised of a strong team that includes the Conference Chair, the Program Coordination Chair and co-Chair, seven executive Sub-Conference Chairs and 365 experts in the field of Computers in Education from 41 different countries or economies. Former ICCE local organizing and program coordination chairs have played the role of consultants in overseeing the conference organization process.

In total, the conference received a total of 266 papers (155 full, 52 short, and 59 posters) from 30 different countries or economies. Table 1 provides the submissions by country of the first author of individual paper. All papers were subjected to a rigorous review process by 2-4 reviewers from the respective sub conference program committees. After a discussion period within the individual program committees led by the sub conference Executive Co-Chairs and Co-Chairs, recommendations were made to the Coordination Committee Chair and Co-Chair. They made sure that the review process for all sub-conferences maintained the highest standards. This resulted in 39 full, 90 short, and 79 poster acceptances across all of the sub-conferences. The overall acceptance rate for full papers is 25%, and overall acceptance rate is 78%. The complete statistics of paper acceptances is shown in Table 2.

Table 1: Distribution of Paper Submissions for ICCE 2014

country			
Australia	2	Malaysia	14
Austria	1	Netherlands	1
Brazil	1	New Zealand	3
Canada	3	Philippines	2
China	14	Singapore	13
Czech Republic	1	Spain	4
Finland	2	Sri Lanka	1
Germany	8	Swaziland	1
Hong Kong	6	Sweden	6
India	3	Taiwan	61
Indonesia	9	Thailand	7
Ishida	1	Tunisia	1
Israel	1	United Kingdom	3
Japan	98	United States	3
Kenya	1	Viet Nam	1
Korea	2		

The acceptance rate for the full papers in the individual sub-conferences closely mirrored the overall acceptance rate. This is a testimony to the continued maintenance of the quality of presentations in our conference. The number of submissions and the acceptance rate for each sub conference is summarized in Table 3.

Table 2: Results of the overall reviewing process for ICCE 2014

	Full papers	Short papers	Posters
Submissions	155	52	59
Results: Full page acceptance rate= 25% Overall acceptance rate= 78%			
Full papers	39(25%)		
Short papers	56	34(65%)	
Posters	37	6	36(61%)
Reject	23	12	23

Table 3: Breakdown of submission and acceptance by sub-conference

Sub Conference	C1	C2	C3	C4	C5	C6	C7
	accepted (submitted)						
Full	6(24)	6(27)	5(18)	7(29)	4(14)	4(16)	7(27)
Short	3(8)	6(6)	10(13)	7(16)	6(10)	10(14)	10(23)
Poster	6(14)	6(18)	7(11)	12(14)	6(9)	11(14)	4(6)

Last, the main conference schedule includes the all-important keynote speakers: (1) Professor Marlene SCARDAMALIA from OISE/University of Toronto, Canada (“Designs for Principle-Based Innovation in Education,” representing sub-conference C2), (2) Professor Yvonne ROGERS from University College London, UK (“Can new technology change learning for the better? ,” representing sub-conference C4), and (3) Professor Kurt SQUIRE from University of Wisconsin-Madison, USA (“Fostering authentic participation in science through games ,” representing sub-conference C5); the distinguished invited speaker: Professor Noriko H. ARAI from National Institute of Informatics, Japan (“The impact of A.I. on education - Can a robot get into the University of Tokyo?”); the theme-based invited speakers: (1) Professor Yu-Ju LAN from National Taiwan Normal University, Taiwan (“Language learning in virtual worlds: embodied, immersive, and interactive,” representing sub-conference C6,) (2) Professor Yasuhisa Tamura from Sophia University, Japan (“Digital Textbooks: Trends and Standardization,” representing sub-conference C3), and (3) Professor Huang-Yao HONG from National Chengchi University, Taiwan (“Cultivating design thinking in teaching with technology,” representing sub-conference C7); and the special invited speaker: Professor Miguel NUSSBAUM from The Computer Science Department of the School of Engineering of Pontificia Universidad Católica de Chile (“Using Technology as Scaffolding for Teaching Critical Thinking in the Classroom”).

In addition, there will be two panel sessions: (1) “Can or should learning be seamless most of the time? The flip side of Mobile Seamless Learning ...” (moderator: Professor Lung-Hsiang Wong from Nanyang Technological University, Singapore), (2) “Innovative programs and national policy of ICT in education in the Asia-Pacific region: looking back and moving forward” (moderator: Professor Fu-Yun YU, National Cheng Kung University, Taiwan).

The first two days of the conference are devoted to pre-conference events. This year they include 16 workshops, two interactive events, one tutorial, and the Doctoral Student Consortia, which will include 12 pre-doctoral student presentations followed by mentoring activities conducted by top-notch researchers. The Workshop papers are published in separate proceedings with its own ISBN number.

We would like to thank everyone who has been involved directly or indirectly in making these proceedings come to fruition, and we hope for a resounding success. We would like to thank all paper authors for your exciting research contributions and choosing ICCE 2014 as the outlet to present your works. Moreover, we would like to thank the IPC and the Executive Chairs who undertook the responsibility of selecting and reviewing papers. We also would like to thank our keynote and invited speakers for accepting our invitations. Last but not least, the biggest thank goes to the Local Organization Committee for their hard work under the tremendous schedule pressure.

We hope that you will find all the activities in ICCE 2014 to be insightful, interesting, and inspiring. Please enjoy the academic activities of ICCE 2014 and the vibrant and colorful culture experiences in Nara.

Program Coordination Chairs:



Chen-Chung LIU (Chair)
National Central University
Taiwan



Hiroaki OGATA (Co-Chair)
Kyushu University
Japan

2 ORGANIZATION

ORGANIZED BY:

Asia Pacific Society for Computers in Education

HOSTED BY:

Japanese Society for Information and Systems in Education

Japan Society for Educational Technology

Japanese Association for Education of Information Studies

CONFERENCE CHAIR:

Siu Cheung KONG, Hong Kong Institute of Education, Hong Kong

INTERNATIONAL PROGRAM COMMITTEE (IPC)

IPC Coordination Chair:

Chen-Chung LIU, National Central University, Taiwan

Co-Chair: Hiroaki OGATA, Kyushu University, Japan

Workshop/Tutorial/Interactive Event Coordination Chair:

Ying-Tien WU, National Central University, Taiwan

Co-Chairs: Thepchai SUPNITHI, National Electronics and Computer Technology Center, Thailand
Tomoko KOJIRI, Kansai University, Japan

Poster Coordination Chair:

Ahmad Fauzi Mohd Ayub, Universiti Putra Malaysia, Malaysia

Co-Chairs: Tatsunori MATSUI, Waseda University

Doctoral Student Consortia Co-Chairs:

Ben CHANG, National Central University, Taiwan

Wei-qin CHEN, University of Bergen, Norway

Xiaoqing GU, East China Normal University, China

Merit Scholarship Committee Co-Chairs:

Su Luan WONG, Universiti Putra Malaysia, Malaysia

Yanjie SONG, The Hong Kong Institute of Education, Hong Kong

Amali Weerasinghe, The University of Adelaide, Australia

Paper Award Committee Members:

Gautam BISWAS, Vanderbilt University, USA

Ming-Puu CHEN, National Taiwan Normal University, Taiwan

Tsukasa HIRASHIMA, Hiroshima University, Japan

Siu Cheung KONG, Hong Kong Institute of Education, Hong Kong

Chee-Kit LOOI, Nanyang Technological University, Singapore

Tanja MITROVIC, University of Canterbury, New Zealand

Yanjie SONG, The Hong Kong Institute of Education, Hong Kong

Chin-Chung TSAI, National Taiwan University of Science and Technology, Taiwan

Meng-Jung Tsai, National Taiwan University of Science and Technology, Taiwan

Su Luan WONG, Universiti Putra Malaysia, Malaysia

Jie-Chi YANG, National Central University, Taiwan

Theme-based Conferences Program Co-Chairs:

C1: ICCE Conference on Artificial Intelligence in Education/Intelligent Tutoring System (AIED/ITS) and Adaptive Learning (AL)

Yusuke HAYASHI, Hiroshima University, Japan (Executive Chair)
Amali WEERASINGHE, The University of Adelaide, Australia
Julita VASSILEVA, University of Saskatchewan, Canada
Barbara WASSON, University of Bergen, Norway

C2: ICCE Conference on Computer-supported Collaborative Learning (CSCL) and Learning Sciences (LS)

Jun OSHIMA, Shizuoka University, Japan (Executive Chair)
Wenli CHEN, Nanyang Technological University, Singapore
Ulrike CRESS, Knowledge Media Research Center, Germany
Clark CHINN, Rutgers University, USA

C3: ICCE Conference on Advanced Learning Technologies, Open Educational Content, and Standards (ALS)

Yukihiro MATSUBARA, Hiroshima City University, Japan (Executive Chair)
Jon MASON, Charles Darwin University, Australia
Robby ROBSON, CEO and Chief Scientist, Eduworks Corporation, USA

C4: ICCE Conference on Classroom, Ubiquitous and Mobile Technologies Enhanced Learning (CUMTEL)

Morris S. Y. JONG, The Chinese University of Hong Kong, Hong Kong (Executive Chair)
Chengjiu YIN, Kyushu University, Japan
KINSHUK, Athabasca University, Canada
Marc JANSEN, University of Applied Sciences Ruhr West, Germany

C5: ICCE Conference on Digital Game and Digital Toy Enhanced Learning and Society (GTEL&S)

Maiga CHANG, Athabasca University, Canada (Executive Chair)
Hsin-Yih SHYU, Tamkang University, Taiwan
Li ZHANG, University of Northumbria, UK
Rita KUO, Knowledge Square, Ltd., USA

C6: ICCE Conference on Technology Enhanced Language Learning (TELL)

Masanori YAMADA, Kyushu University, Japan (Executive Chair)
Yu-Ju LAN, National Taiwan Normal University, Taiwan
Regine HAMPEL, The Open University, UK
Lara LOMICKA-ANDERSON, University of South Carolina, USA

C7: ICCE Conference on Practice-driven Research, Teacher Professional Development and Policy of ICT in Education (PTP)

Ching-Sing CHAI, Nanyang Technological University, Singapore (Executive Chair)
Ying-Tien WU, National Central University, Taiwan
Jianwei ZHANG, State University of New York at Albany, USA
Yongwu MIAO, University Duisburg-Essen, Germany
Jack HSU, National Pingtung University of Science and Technology, Taiwan

Consultants:

Wenli CHEN, Nanyang Technological University, Singapore
Muhammad LUKMAN, University of Muhammadiyah, Indonesia
Lung-Hsiang WONG, Nanyang Technological University, Singapore

Special Interest Groups (SIG) Chairs:

Thepchai SUPNITHI, National Electronics and Computer Technology Center, Thailand (AIED/ITS/AL)
Wenli CHEN, Nanyang Technological University, Singapore (Co-Chair, CSCL/LS)
Chiu-Pin LIN, National Hsinchu University of Education, Taiwan (Co-Chair, CSCL/LS)
Yukihiro MATSUBARA, Hiroshima City University, Japan (ALT/OC/S)
Hyo-Jeong SO, Pohang University of Science & Technology (POSTECH), Korea (CUMTEL)
Masanori SUGIMOTO, Hokkaido University, Japan (GTEL&S)
Jie-Chi YANG, National Central University, Taiwan (TELL)
Fu-Yun YU, National Cheng Kung University, Taiwan (PTP)
Ahmad Fauzi Mohd Ayub, Universiti Putra Malaysia, Malaysia (DICTAP)

LOCAL ORGANIZING COMMITTEE (LOC)

Chair Akihiro KASHIHARA, The University of Electro-Communications

Financial Co-Chair: Shinobu HASEGAWA, Japan Advanced Institute of Science and Technology

Local Arrangement Co-Chair: Masato SOGA, Wakayama University

Printing Co-Chair: Hiroaki OGATA, Kyushu University

Publicity Co-Chair: Tatsuya HORITA, Tohoku University

Registration, Accommodation, Transportation Co-Chair: Ryo TAKAOKA, Yamaguchi University

Web Site Management Co-Chair: Hiroyuki MITSUHARA, University of Tokushima

Social Event Co-Chair: Masao MUROTA, Tokyo Institute of Technology

Sponsorship Co-Chair: Yasuhisa KATO, NTT Service Evolution Laboratories

Technical Support Co-Chair: Kenji MATSUURA, University of Tokushima

Members: Kanji AKAHORI, Hakuoh University
Chengjiu YIN, Kyushu University
Yoshimi FUKUHARA, Meiji University
Yasushi FUWA, Shinshu University
Yoshiko GODA, Kumamoto University
Naka GOTODA, Japan Institute of Sports Sciences
Toshihiro HAYASHI, Kagawa University
Yusuke HAYASHI, Hiroshima University
Tsukasa HIRASHIMA, Hiroshima University
Tomoya HORIGUCHI, Kobe University
Mitsuru IKEDA, Japan Advanced Institute of Science and Technology
Tomoo INOUE, Tsukuba University
Yukihiro ITOH, Shizuoka University

Kazuhide KANENISHI, University of Tokushima
Toshinobu KASAI, Okayama University
Tomoko KOJIRI, Kansai University
Hidekuni KOMATSU, e-Learning Consortium Japan
Tatsuhiko KONISHI, Shizuoka University
Fumiko KONNO, Tohoku University
Hidenobu KUNICHIKA, Kyushu Institute of Technology
Fusako KUSUNOKI, Tama Art University
Yukie MAJIMA, Osaka Prefecture University
Hiroyuki MASUKAWA, Shizuoka University
Yukihiro MATSUBARA, Hiroshima City University
Noriyuki MATSUDA, Wakayama University
Tatsunori MATSUI, Waseda University
Takashi MITSUISHI, Tohoku University
Kazuhisa MIWA, Nagoya University
Yasuo MIYOSHI, Kochi University
Masayuki MURAKAMI, Kyoto University of Foreign Studies
Keizo NAGAOKA, Waseda University
Kiyoshi NAKABAYASHI, Chiba Institute of Technology
Jun NAKAHARA, University of Tokyo
Ritsuko NISHIBATA, Kio University
Masayuki NUMAO, Osaka University
Youji OCHI, Kinki University
Noboru OHKUBO, Uchida Yoko
Ryo OKAMOTO, Kochi University
Jun OHSHIMA, Shizuoka University
Wakio OYANAGI, Nara University of Education
Hitoshi SASAKI, Takushoku University
Kazuhisa SETA, Osaka Prefecture University
Masanori SUGIMOTO, Hokkaido University
Katsuaki SUZUKI, Kumamoto University
Akira TAKEUCHI, Kyushu Institute of Technology
Hiroyuki TARUMI, Kagawa University
Maomi UENO, University of Electro-Communications
Hiroyoshi WATANABE, Teikyo University
Kenzi WATANABE, Hiroshima University
Masanori YAMADA, Kyushu University
Atsushi YOSHIKAWA, The Japan Institute for Educational Measurement, Inc.

Advisors: Riichiro MIZOGUCHI, Japan Advanced Institute of Science and Technology
Yoneo YANO, Tokushima Bunri University
Takanori MAESAKO, Osaka University
Junichi YAMANISHI, Toyama University
Kazuo NAGANO, University of the Sacred Heart, Tokyo
Toshio OKAMOTO, The Kyoto College of Graduate Studies for Informatics

Liaisons: JSiSE: Kiyoshi NAKABAYASHI, Chiba Institute of Technology
JSET: Masao MUROTA, Tokyo Institute of Technology
JAEIS: Mizue KAYAMA, Shinshu University

Funded by: The Telecommunications Advancement Foundation
Tateisi Science and Technology Foundation
KANSAI • OSAKA 21st Century Association
KDDI Foundation
SCAT (Support Center for Advanced Telecommunications Technology Research,

Foundation)
Nara Visitors Bureau



KDDI
KDDI Foundation



助成 日本万国博覧会記念基金
Supported by the Japan World Exposition 1970 Commemorative Fund.
この助成金は、日本万国博覧会の収益を基にしています。
公益財団法人 関西・大阪21世紀協会

Sponsored by

Platinum Sponsor:

UCHIDA YOKO CO., LTD.

Epson Sales Japan Corp.

Gold Sponsor:

DATA PACIFIC (JAPAN) LTD.

PHOTRON LIMITED

Asahi Net, Inc.

Fujitsu Limited

Silver Sponsor:

Pro-Seeds Co., Ltd.

C1 Program Committee members:

Dietrich ALBERT, Graz University of Technology, Austria
Sagaya AMALATHAS, University of Canterbury, New Zealand
Roger AZEVEDO, McGill University, Canada
Nilufar BAGHAEI, Unitec, New Zealand
Gautam Biswas, Vanderbilt University, USA
Susan BULL, University of Birmingham, UK
Marut BURANARACH, National Electronics and Computer Technology Center, Thailand
Chih-Yueh CHOU, Yuen Ze University, Taiwan
Ben DU BOULAY, University of Sussex, UK
Claude FRASSON, University of Montreal, Canada
Enrique FRIAS-MARTINEZ, Telefonica Investigacion y Desarrollo, Spain
George GHINEA, Brunel University, UK
Eduardo GUZMÁN, University of Malaga, Spain
Shinobu HASEGAWA, Japan Advanced Institute of Science and Technology, Japan
Tsukasa HIRASHIMA, Hiroshima University, Japan
Ulrich HOPPE, University of Duisburg-Essen, Germany
Tomoya HORIGUCHI, Kobe University, Japan
Seiji ISOTANI, University of Sao Paulo, Brazil
Sridhar IYER, Indian Institute of Technology Mumbai, India
Akihiro KASHIHARA, Electro-Communication University, Japan
Kazuaki KOJIMA, Waseda University, Japan
Tomoko KOJIRI, Kansai University, Japan
Siu Cheung KONG, The Hong Kong Institute of Education, Hong Kong
Tatsuhiko KONISHI, Shizuoka University, Japan
Hidenobu KUNICHIKA, Kyushu Institute of Technology, Japan
Chad LANE, University of South California, USA
Lydia LAU, University of Leeds, UK
Nguyen-Thanh LE, Clausthal University of Technology, Germany
Krittaya LEELAWONG, Mahidol University International College, Thailand
Chi-Jen LIN, Fo Guang University, Taiwan
Moffat MATHEWS, University of Canterbury, New Zealand
Yukihiro MATSUBARA, Hiroshima City University, Japan
Noboru MATSUDA, Carnegie Mellon University, USA
Noriyuki MATSUDA, Wakayama University, Japan
Tatsunori MATSUI, Waseda University, Japan
Gordon McCALLA, University of Saskatchewan, Canada
Tanya MITROVIC, University of Canterbury, New Zealand
Kazuhisa MIWA, Nagoya University, Japan
Riichiro MIZOGUCHI, Japan Advanced Institute of Science and Technology, Japan
Norwati MUSTAPHA, Universiti Putra Malaysia, Malaysia
Jitti NIRAMITRANON, Kasetsart University, Thailand
Athitaya NITSHOT, National Electronics and Computer Technology Center, Thailand
Helen PAIN, University of Edinburgh, UK
Jose Luis PEREZ DE LA CRUZ, Universidad de Malaga, Spain
Elvira POPESCU, University of Craiova, Romania
Mercedes RODRIGO, Ateneo de Manila University, Philippines
Kazuhisa SETA, Osaka Prefecture University, Japan
Pokpong SONGMUANG, Thammasat University, Thailand
Sergey SOSNOVSKY, DFKI, Germany
Thepchai SUPNITHI, National Electronics and Computer Technology Center, Thailand
Monica TRELLA, Universidad de Malaga, Spain
Diego ZAPATA-RIVERA, Educational Testing Service, USA

C2 Program Committee members:

Daniel BODEMER, University Duisburg-Essen, Germany
Tak-Wai CHAN, National Central University, Taiwan
Wenli CHEN, NIE, Singapore
Yu-Hui CHING, Boise State University, USA
Clark CHINN, Rutgers University, USA
Ulrike CRESS, Knowledge Media Research Center, Germany
Joshua A. DANISH, Indiana University, USA
Hideo FUNAOI, Souka University, Japan
Xiaoqing GU, East China Normal University, China
Tessai HAYAMA, Kanazawa Institute of Technology, Japan
Yugo HAYASHI, University of Tsukuba, Japan
Tsukasa HIRASHIMA, Hiroshima University, Japan
Huang-Yao HONG, National Chengchi University, Taiwan
Kian Sam HONG, Universiti Malaysia Sarawak, Malaysia
Ronghuai HUANG, Beijing Normal University, China
Heisawn JEONG, Hallym University, Republic of Korea
Hiroshi KATO, Open University, Japan
Beaumie KIM, University of Calgary, Canada
Timothy KOSCHMANN, Southern Illinois University, USA
Eleni KYZA, Cyprus University of Technology, Cyprus
James LAFFEY, University of Missouri, USA
Yanyan LI, Beijing Normal University, China
Rose LIANG, National University of Singapore, Singapore
Chiu-Pin LIN, National Hsinchu University of Education, Taiwan
Chen-Chung LIU, National Central University, Taiwan
Chee-Kit LOOI, Nanyang Technological University, Singapore
Rosemary LUCKIN, The London Knowledge Lab, UK
Hiroyuki MASUKAWA, Shizuoka University, Japan
Toshio MOCHIZUKI, Senshu University, Japan
Sahana MURTHY, Indian Institute of Technology Mumbai, India
Jun OSHIMA, Shizuoka University, Japan
Ritsuko OSHIMA, Shizuoka University, Japan
Peter REINMANN, University of Sydney, Australia
Dirk RIEHLE, Friedrich-Alexander University of Erlangen-Nürnberg, Germany
Ronald RINEHART, Rutgers University, USA
Lars SORENSEN, Rutgers University, USA
Hideyuki SUZUKI, Ibaraki University, Japan
Seng Chee TAN, Nanyang Technological University, Singapore
Etsuji YAMAGUCHI, Kobe University, Japan
Jennifer WEIBLE, Pennsylvania State University, USA
Lung Hsiang WONG, Nanyang Technological University, Singapore
Jianhua ZHAO, South China Normal University, China

C3 Program Committee members:

Luis ANIDO, University of Vigo, Spain
Kumiko AOKI, The Open University of Japan, Japan
David ASIRVATHAM, University of Malaya, Malaysia
Chih-Kai CHANG, National University of Tainan, Taiwan
Irene CHEN, National Changhua University of Education, Taiwan
Tsung-Yen CHUANG, National University of Tainan, Taiwan
Jean-Noel COLIN, University of Namur, Belgium
Ingo DAHN, University of Koblenz, Germany
Giovanni FULANTELLI, Italian National Research Council, Italy
Seungyeon HAN, Hanyang Cyber University, Korea
Yusuke HAYASHI, Hiroshima University, Japan
Tore HOEL, Oslo and Akershus University College of Applied Sciences, Norway
Jeff Cheng-Hsu HUANG, Hwa-Hsia Institute of Technology, Taiwan
Ray Yueh-Min HUANG, National Cheng-Kung University, Taiwan
Rozhan M. IDRUS, Universiti Sains Malaysia, Malaysia
Yih-Ruey JUANG, Jinwen University of Science and Technology, Taiwan
Abtar KAUR, Open University Malaysia, Malaysia
Fanny KLETT, German Workforce ADL Partnership Lab, Germany
Tatsuhiko KONISHI, Shizuoka University, Japan
Hidenobu KUNICHIKA, Kyushu Institute of Technology, Japan
Eugenijus KURILOVAS, Vilnius University, Lithuania
Lam-for KWOK, City University of Hong Kong, Hong Kong
Tien-Dung LE, European Schoolnet, Belgium
Chien-Sing LEE, Universiti Tunku Abdul Rahman, Malaysia
Jerry LEESON, University of Adelaide, Australia
Ching-Jung LIAO, Chung Yuan Christian University, Taiwan
Kin Chew LIM, SIM University, Singapore
Kenji MATSUURA, Tokushima University, Taiwan
Masaru OKAMOTO, Hiroshima City University, Japan
Tomasz ORZECZOWSKI, AGH UST, Poland
Kuo-Liang OU, National Hsinchu University of Education, Taiwan
Allyn RADFORD, Deakin University, Australia
Manuel Caeiro RODRIGUEZ, University of Vigo, Spain
Hitoshi SASAKI, Takushoku University, Japan
Onjira SITTHISAK, Thaksin University, Thailand
Giannis STOITSIS, Agro-Know Technologies, Greece
Christian STRACKE, University of Duisburg-Essen, Germany
Stefaan TERNIER, Open Universiteit, The Netherlands
Nguyen VIET HA, Vietnam National University, Vietnam
Riina VUORIKARI, Institute for Prospective Technological Studies, Belgium
Maggie M. WANG, The University of Hong Kong, Hong Kong
Hiroyoshi WATANABE, Teikyo University, Japan

C4 Program Committee members:

Brenda BANNAN, Pennsylvania State University, USA
Rosanna CHAN, The Chinese University of Hong Kong, Hong Kong
Daniel CHURCHILL, University of Hong Kong, Hong Kong
Yanjie SONG, Hong Kong Institute of Education, Hong Kong
Ray Yueh-Min HUANG, National Cheng Kung University, Taiwan
Tzung-Shi CHEN, National University of Tainan, Taiwan
Carol CHU, Soochow University, Taiwan
Hsien-Sheng HSIAO, National Taiwan Normal University, Taiwan
Gwo-Jen HWANG, National University of Science and Technology, Taiwan
Yih-Ruey JUANG, Jinwen University of Science and Technology, Taiwan
Chen-Chung LIU, National Central University, Taiwan
Chiu-Pin LIN, National HsinChu University of Education, Taiwan
Jun-Ming SU, National Taiwan Jiao Tung University, Taiwan
Gwo-Haur HWANG, Ling Tung University, Taiwan
Chengjiu YIN, Kyushu University, Japan
Masato SOGA, Wakayama University, Japan
Hiroaki OGATA, University of Tokushima, Japan
Masao MUROTA, Tokyo Institute of Technology, Japan
Yusuke MORITA, Waseda University, Japan
Tomoo INOUE, University of Tsukuba, Japan
Yoshiaki HADA, The Open University of Japan, Japan
Noriko UOSAKI, Osaka University, Japan
Haiguang FANG, Capital Normal University, China
Xiaoqing GU, East China Normal University, China
Junjie SHANG, Peking University, China
Su CAI, Beijing Normal University, China
Irfan UMAR, University of Science, Malaysia
Ivica BOTICKI, University of Zagreb, Croatia
Serge GARLATTI, Telecom Bretagne, France
Ulrich HOPPE, University of Duisburg-Essen, Germany
Marco KALZ, The Open Universiteit in the Netherlands, The Netherlands
Marcelo MILRAD, Linnaeus University, Sweden
Marcus SPECHT, The Open Universiteit in the Netherlands, The Netherlands
Jane YAU, Malmo University, Sweden
Herman van der MERWE, North West University, South Africa
Adam Giemza, University of Duisburg-Essen, Germany
Lars Bollen, University of Twente, The Netherlands
Christian GLAHN, ETH Zurich, Switzerland
Jo WAKE, University of Bergen, Norway
Barbara WASSON, University of Bergen, Norway
Zane BERGE, University of Maryland, Baltimore County, USA
Maiga CHANG, Athabasca University, Canada
Moushir ELBISHOUTY, Athabasca University, Canada
Heng-Yu KU, University of Northern Colorado, USA
Oscar LIN, Athabasca University, Canada
Lin MUILENBERG, St. Mary's College of Maryland, USA
Elliot SOLOWAY, University of Michigan, USA
Qing TAN, Athabasca University, Canada
Gustavo ZURITA, University of Chile, Chile

C5 Program Committee members:

Fernández-Manjón BALTASAR, Universidad Complutense de Madrid, Spain
Tak-Wai CHAN, National Central University, Taiwan
Ben CHANG, National Chiayi University, Taiwan
Chih-Kai CHANG, National University of Tainan, Taiwan
Chiung-Sui CHANG, Tamkang University, Taiwan
Maiga CHANG, Athabasca University, Canada
Yuan-Jen CHANG, Central Taiwan University of Science and Technology, Taiwan
Ming-Puu CHEN, National Taiwan Normal University, Taiwan
Nian-Shing CHEN, National Sun Yat-Sen University, Taiwan
Zhi-Hon CHEN, Yuan-Ze University, Taiwan
John I-Tsun CHIANG, National Changhua University of Education, Taiwan
Tsung-Yen CHUANG, National University of Tainan, Taiwan
Moushir EL-BISHOUTY, Athabasca University, Canada
Mathew Joseph GAYDOS, National Institute of Education, Singapore
Toshihiro HAYASHI, Kagawa University, Japan
Huei-Tse HOU, National Taiwan University of Science and Technology, Taiwan
Jun HU, Eindhoven University of Technology, Netherlands
Gwo-Jen HWANG, National Taiwan University of Science and Technology, Taiwan
Ido IURGEL, Rhine-Waal University, Germany
Minfong JAN, Nanyang Technological University, Singapore
Morris S. Y. JONG, The Chinese University of Hong Kong, Hong Kong
Beaumie KIM, University of Calgary, Canada
Kinshuk, Athabasca University, Canada
Paul KUO, National Palace Museum, Taiwan
Rita KUO, Knowledge Square Ltd., USA
Fong-Lok LEE, The Chinese University of Hong Kong, Hong Kong
Jimmy Ho-Man LEE, The Chinese University of Hong Kong, Hong Kong
Hao-Chiang Koong LIN, National University of Tainan, Taiwan
Eric Zhi-Feng LIU, National Central University, Taiwan
Hiroyuki MITSUHARA, Tokushima University, Japan
Wolfgang MUELLER, University of Education Weingarten, Germany
Demetrios G. SAMPSON, University of Piraeus, Greece
Junjie SHANG, Peking University, China
Chun-Yi SHEN, Tamkang University, Taiwan
Ju-Ling SHIH, National University of Tainan, Taiwan
Ru-Chu SHIH, National Pingtung University of Science & Technology, Taiwan
Hsin-Yih SHYU, Tamkang University, Taiwan
Chuen-Tsai SUN, National Chiao Tung University, Taiwan
Hiroyuki TARUMI, Kagawa University, Japan
Christopher WALSH, Torrens University Australia and The Open University (UK), Australia & UK
Yu-Ren YEN, Far East University, Taiwan
Shelley Shwu-Ching YOUNG, National Tsing Hua University, Taiwan
Nelson ZAGALO, University of Minho, Portugal
Li ZHANG, University of Northumbria, UK

C6 Program Committee members:

Mathew ABSALAM, The University of Melbourne, Australia
Nike ARNOLD, Portland State University, USA
Jun-ichi AZUMA, Juntendo University, Japan
Rebecca BABCOCK, University of Texas of the Permian Basin, USA
Emerita BANADOS, Universidad de Concepcion, Chile
Alex BOULTON, Nancy University, France
Mei Mei CHANG, National Pingtung University of Science and Technology, Taiwan
Howard CHEN, National Taiwan Normal University, Taiwan
Shu-Mei CHWO, Hungkuang University, Taiwan
Liliana CUESTA, Universidad de La Sabana, Colombia
Lara DUCATE, University of South Carolina, USA
Carolyn FUCHS, Columbia University, USA
Ana GIMENO-SANZ, Universidad Polit?cnica de Valencia, Spain
Yoshiko GODA, Kumamoto University, Japan
Scott GRANT, Monash University, Australia
Sarah GUTH, University of Padua, Italy
Mirjam HAUCK, The Open University, UK
Yueh-Min HUANG, National Cheng kung University, Taiwan
Phil HUBBARD, Stanford University, USA
Ching-Kun Hsu, National Taiwan Normal University, Taiwan
Nicole KENG, Coventry University, UK
Rick KERN, University of Berkeley, USA
Makiko KISHI, Meiji University, Japan
Chin-Hwa KUO, Tamkang University, Taiwan
Hsing-chin LEE, National Taipei College of Business, Taiwan
Jae-Ho LEE, University of Tsukuba
Jia (Joan) LI, University of Ontario Institute of Technology, Canada
Chih-cheng LIN, National Taiwan Normal University, Taiwan
Tsun-Ju Lin, KaiNan University, Taiwan
Chao-Hong LIU, National Cheng Kung University, Taiwan
Yi-chun LIU, Taiwan, Chia Nan University of Pharmacy and Science, Taiwan
Gillian LORD, University of Florida, USA
Takeshi MATSUDA, Shimane University, Japan
Hideya MATSUKAWA, Osaka University, Japan
Kahoko MATSUMOTO, Tokai University, Japan
Carlos Rub?n MONTORO SANJOS?, the University of Guanajuato, Mexico
Masayuki MURAKAMI, Kyoto University of Foreign Studies
Jo MYNARD, Kanda University of International Studies, Japan
Toshihisa NISHIMORI, Osaka University, Japan
Fang-Chuan OU YANG, Chien Hsin University of Science and Technology, Taiwan
Makiko OYAMA, Osaka University, Japan
Seijiro SUMI, Ryutu Keizai University, Japan
Ruslan SUVOROV, Yale University, USA
Siew Ming THANG, Universiti Kebangsaan, Malaysia
Junpei TOKITO, Yamagata University
Yasuhiko TSUJI, The Open University of Japan, Japan
Takafumi UTASHIRO, Hokkai Gakuen University, Japan
Takehiro WAKIMOTO, Aoyama Gakuin University, Japan
Yuki WATANABE, Tokyo Metropolitan University, Japan
Jie Chi YANG, National Central University, Taiwan
Hui-Chin YEH, National Yunlin University of Science and Technology, Taiwan

C7 Program Committee members:

Zoraini Wati ABAS, Open University Malaysia, Malaysia
Diana ANDONE, Politehnica University of Timisoara, Romania
Yayoi ANZAI, Aoyama Gakuin University, Japan
Guat Poh AW, Nanyang Technological University, Singapore
Hsin-Yi CHANG, National Kaohsiung Normal University, Taiwan
Mei-Mei CHANG, National Pingtung University of Science and Technology, Taiwan
Yam San CHEE, Nanyang Technological University, Singapore
Bodong CHEN, University of Minnesota, USA
Pearl CHEN, California State University, USA
Weiqin CHEN, University of Bergen, Oslo and Akershus University, Norway
Kun-Hung CHENG, National Chiao Tung University, Taiwan
Mon-Tzy CHENG, National Changhua University of Education, Taiwan
Wing Sum CHEUNG, Nanyang Technological University, Singapore
Yu-Hui CHING, Boise State University, USA
Yu-Fang CHIOU, National Taichung University of Education, Taiwan
Yen-Lin CHIU, National Taiwan University of Science and Technology, Taiwan
Daniel CHURCHILL, Hong Kong University, Hong Kong
Yan DON, Beijing Normal University, China
Michael A EVANS, Virginia Tech, USA
Sabine GRAF, Athabasca University, Canada
Deniz GÜRÇAY, Hacettepe Üniversitesi, Turkey
Hsin-Ning HO, University of Southern California, USA
Huang-Yao HONG, National Chengchi University, Taiwan
Ching-Kun HSU, National Taiwan Normal University, Taiwan
Yu-Chang HSU, Boise State University, USA
Hui JIN, Shanghai University of Foreign Studies, China
Djordje M. KADIJEVICH, Mathematical Institute of Serbian Academy of Science and Arts, Serbia
Chia-Pin KAO, Southern Taiwan University of Science and Technology, Taiwan
Joyce Hwee Ling KOH, Nanyang Technological University, Singapore
Hsin-Chih LAI, Chang Jung Christian University, Taiwan
Kwok-Wing LAI, University of Otago College of Education, New Zealand
Yiu Chi LAI, The Hong Kong Institute of Education, Hong Kong
Chwee Beng LEE, University of Western Sydney, Australian
Ji-Yeon LEE, Inha University, S. Korea
Sung-Tao LEE, National Taichung University of Education, Taiwan
Jing LEI, Syracuse University, USA
Wenhao LI, Central China Normal University, China
Shu-Sheng LIAW, China Medical University, Taiwan
Chiu-Pin LIN, National Hsinchu University of Education, Taiwan
Hung-Ming LIN, Minghsin University of Science and Technology, Taiwan
Jing-Wen LIN, National Dong Hua University, Taiwan
Tzu-Chiang LIN, National Taiwan University of Science and Technology, Taiwan
Ru-De LIU, Beijing Normal University, China
Shi-Jer LOU, National Pingtung University of Science and Technology, Taiwan
Will MA, Hong Kong Shue Yan University, Hong Kong
David Richard MOORE, Ohio University, USA
Mee Wah Eugenia NG, The Hong Kong Institute of Education, Hong Kong
Siew Ling Connie NG, Nanyang Technological University, Singapore
John Eu Gene OW, Nanyang Technological University, Singapore
Wakio OYANAGI, Nara University of Education, Japan
Shu-chien PAN, Ohio University, USA
Patcharin PANJABUREE, Mahidol University, Thailand
Kin Man POON, The Hong Kong Institute of Education, Hong Kong
Elvira POPESCU, University of Craiova, Romania

GuoYuan SANG, Beijing Normal University, China
Peter Sen Kee SEOW, Nanyang Technological University, Singapore
Rustam SHADIEV, National Cheng Kung University, Taiwan
Ru-Chu SHIH, National Pingtung University of Science and Technology, Taiwan
Niwat SRISAWASDI, Khon Kaen University, Thailand
Daner SUN, Nanyang Technological University, Singapore
Katsuaki SUZUKI, Kumamoto University, Japan
Seng Chee TAN, Nanyang Technological University, Singapore
Meng-Jung TSAI , National Taiwan University of Science and Technology, Taiwan
Pei-Shan TSAI, Nanyang Technological University, Singapore
Radu VASIU, Polytechnic University of Timisoara, Romania
Hsiao-Shen WANG, National Taicung University of Education, Taiwan
Jing-Ru WANG, National Pingtung University of Education, Taiwan
Qiyun WANG, Nanyang Technological University, Singapore
Shu-Ming WANG, Chinese Culture University, Taiwan
Ying WANG, Jiangsu Normal University, China
Chun-Wang WEI, Far East University, Taiwan
Shih-Hsuan WEI, National Taiwan University of Science and Technology, Taiwan
Meichun Lydia WEN, National Changhua University of Education, Taiwan
Angela Foong Lin WONG, Nanyang Technological University, Singapore
Gary K.W. WONG, The Hong Kong Institute of Education, Hong Kong
Su Luan WONG, University Putra Malaysia, Malaysia
Longkai WU, Nanyang Technological University, Singapore
Yau-yeun YEUNG, The Hong Kong Institute of Education, Hong Kong
Shengquan YU, Beijing Normal University, China
Yuen Tak YU, City University of Hong Kong, Hong Kong
Hsiu-Ping YUEH , National Taiwan University, Taiwan

3. Distinguished Researcher and Young Researcher Leader Awards

APSCE conducts Distinguished Researcher Award (DRA) and Early Career Research Award (ECRA) every year. DRA recognizes an active APSCE Member who has showed distinguished academic accomplishments and contributions in the field of Computers in Education. The awardee of DRA must be under 50 at the time of nomination. Early Career Research Award recognizes an active APSCE Member in the early stages of his or her career no later than 10 years after receipt of the doctoral degree who has produced international quality research outputs, and be able to demonstrate ambitious and aspirations consistent with the potential to achieve world-leading status. The Awards also recognize contributions to APSCE (e.g. related activities to ICCE or SIGs) or APSCE appointments (e.g. Executive Committee member of APSCE). These awards had been provided every two years since 2009. Starting from 2014, they are provided every year. The awardees are required to contribute a paper to RPTEL, the journal of APSCE, within two years of receiving the award.

For the year 2014, APSCE received one nomination for DRA and one nomination for ECRA. Through the examination of the qualification by the award subcommittee, the two nominees were accepted as a candidate for each award. As there was only one candidate nominated for each award, the 1st voting step for selecting the finalist was skipped. In the next selection step, the finalist will need "2/3" votes of agreement from all the EC members. This is very tough and competitive condition to be a winner.

We are now pleased to announce the award winner of this year's APSCE DRA: Professor Hiroaki Ogata. There is no award winner for ECRA.

In the following page, you will find a record of his scholarship and his services to APSCE. The DRA award winner will receive a Certificate, award money, and will have his/her name publicized on APSCE web site and on the ICCE proceedings. He will also receive nomination for the Keynote/Theme-Based Speaker for the next ICCE.

APSCE Award Subcommittee:

Tsukasa Hirashima(Chair),
Chee-Kit Looi,
Riichiro Mizoguchi

2014 APSCE Distinguished Researcher Award Winner

Dr. Hiroaki Ogata, Kyushu University, Japan.



Dr. Ogata is one of the top researchers from the Asia-Pacific region in the areas of mobile and ubiquitous learning environments (MULE) and computer supported collaborative learning (CSCL). He has very high visibility and reputation world-wide for his contributions to these fields. In his professional research field, he proposed several new concepts of contextualized and ubiquitous language learning in the authentic world which have initiated a new research and development direction in the field of ubiquitous learning.

His outstanding research results have been recognized by the mobile learning community as he was invited to be the keynote speaker in several top-tier conferences of mobile learning such as IEEE WMUTE 2008 in China, Mobile Learning 2009 in Spain, ICET 2009 in Turkey, ICCE 2011 in Malaysia.

The publication record of Dr. Ogata is outstanding with high quality research publications sustained over a longer period of time, notwithstanding that he is still rather young. His publications include over 60 refereed journal articles, more than 200 international conference papers. Several Best Paper Awards (JSiSE 1998, WebNet 1999, IPSJ 2004, ICALT 2006, CollabTech 2008, ICCE 2008, mLearn 2009 and ICCE 2010) underline the excellence of his work. For more details, please visit <http://sites.google.com/site/hiroakiogata/> and <http://scholar.google.com/citations?user=eNbutSkAAAAJ>

Dr. Ogata has been involved in a large number of externally funded research projects such as Grant-in-Aid for Scientific Research from the Ministry of Education (MEXT) and Japan Society for the promotion Science (JSPS), and also PRESTO from Japan Science and Technology Agency (JST). He has been a member of numerous international conference committees and international journal editorial boards and has been invited as guest editor special issues several times. Dr. Ogata organized IEEE WMTE 2005 in Tokushima and has also provided substantial services to the international research community through organizing a series of international workshops on MULE and by providing professional discussion forums for young researchers and PhD students.

Dr. Ogata is currently an executive committee (EC) member of APSCE, and was an EC member of IamLearn (International Association for Mobile Learning) and SOLAR (Society for Learning Analytics and Research). Also Dr. Ogata is currently an associate editor of IEEE Transactions on Learning Technologies (SSCI), RPTTEL (Research and Practice in Technology Enhanced Learning Journal) and IJMLO (International Journal of Mobile and Learning Organization), and an editorial board member of IJCSCL (International Journal of Computer Supported Collaborative Learning) (SSCI), and SLE (International Journal of Smart Learning Environments).

4. Keynotes and invited speakers

KEYNOTE SPEAKER 1

Designs for Principle-Based Innovation in Education



Marlene SCARDAMALIA

Institute for Knowledge Innovation & Technology, OISE/University of Toronto, Canada

Abstract

Iterative idea improvement requires boundless inventiveness. Direct pursuit of idea improvement as an explicit, guiding principle defines Knowledge Building/knowledge creation and contrasts sharply with rule-based processes, scripts, and procedures implicit in most school-based inquiry and learning activities. Idea improvement as a core principle aligns education with creative work as conducted in knowledge creating organizations where work on ill-defined problems fosters emergence of new competencies and outcomes. Schools, in contrast, tend to favor well-defined problems with clear end points. In this talk I pursue the Knowledge Building proposition that principle-based innovation offers a realistic possibility of achieving results in knowledge creation, in addition to addressing common standards and what are popularly known as 21st century skills. By going beyond a skills approach a Knowledge Building design community aims to

extend the range of the possible in education. Participants are globally distributed and represent a diverse network of practitioners, policy makers, researchers, administrators, students, parents, engineers, disciplinary experts and sponsors--all engaged in iterative, interactive knowledge building. To realize opportunities and address challenges the approach is systemic; to function as a coherent program, the models, technologies, assessments, and results serve local needs while evolving to address the needs of a global, research-intensive design lab and test bed. "Knowledge Building hubs of innovation" will demonstrate yearly, measurable advances in principled practice and achievement, with international courses and professional development provided to help achieve this goal. A global open source community will provide essential infrastructure: technology to foster knowledge creation, to amplify collective achievements, and to provide feedback to empower individual teachers and students as well as groups as agents in knowledge advancement. Design research will span elementary to tertiary education, all subject areas, a broad range of socio-economic levels and sectors, and represent great cultural and linguistic diversity. Resultant data repositories will provide the world's most valuable resource for studying knowledge creation in education, positioning the Knowledge Building design community to produce exportable "know-how," meet needs of the public and policy makers, and contribute significantly to knowledge of what students are capable of as junior members of a knowledge society.

KEYNOTE SPEAKER 2

Can new technology change learning for the better?



Yvonne ROGERS

Interaction Centre, University College London, UK

Abstract

There has been a lot of excitement recently about how new technologies can transform learning. MOOCs, the internet of education and flipped classrooms are the latest hotly debated ways of changing how students learn in the modern world. At the same time, a diversity of innovative learning apps has been developed for tabletops, tablets and phones, supporting new forms of learning – mobile, collaborative and situated. New electronic toolkits and programming environments are also emerging intended to introduce new generations to coding and computation in creative and engaging ways. Never before has there been so much opportunity and buzz to make learning accessible, immersive, interactive, exciting, provocative and enjoyable. To realize the true potential of these latest technological developments, however, requires designing interfaces and apps to not only match learner's needs but also to encourage collaboration, mindful engagement, conversational skills and the art of reflection.

KEYNOTE SPEAKER 3

Fostering authentic participation in science through games



Kurt SQUIRE

Curriculum & Instruction, University of Wisconsin-Madison, USA

Abstract

Digital games have received widespread attention among science educators for their capacity for raising interest in science, improving identification with science, introducing inquiry-based learning activities, and produce conceptual understandings. A perennial challenge for educators is how to design such games so as to not just work in schools, but also transform educational practices. This talk highlights research and development from the Games + Learning + Society Center using games to support learning across a wide variety of ages and learning domains. It will cover both design principles and research findings, suggesting how games might contribute to a future of learning in a digitally connected society.

DISTINGUISHED INVITED SPEAKER

The impact of A.I. on education - Can a robot get into the University of Tokyo?



Noriko H. ARAI

National Institute of Informatics, Japan

Abstract

“Todai Robot Project (Can a robot get into the University of Tokyo?)” was initiated by National Institute of Informatics in 2011 as an AI grand challenge. The goal of the project is to create an AI system that answers real questions of university entrance examinations consisting of two parts, the multiple-choice style national standardized tests and the written test including short essays. The task naturally requires the development of ground-breaking elemental technologies in the research areas including natural language processing, image processing, speech recognition, automated theorem proving, computer algebra, and computer simulation. At the same time, it requires the interdisciplinary research synthesis.

In 2013, our software took the mock test of the National Center Test with more than five thousands students. The result shows that its ability is still far below the average entrants of Tokyo University. However, it is beyond the mode: it is competent to pass the entrance exams of 400 out of 800 private universities in Japan. The rapid rise of new AI technologies may affect the labor market negatively in the short term, and it will demand us to reconstruct our education systems.

THEME-BASED INVITED SPEAKER: TELL (C6)

Language learning in virtual worlds: embodied, immersive, and interactive



Yu-Ju LAN

Department of Applied Chinese Language and Culture, National Taiwan Normal University, Taiwan

Abstract

Social interaction plays an important role in the second language acquisition (SLA), whereby the learners and the social context in the real world are connected in an inseparable relationship. In particular, the context-dependent social interaction is most important to SLA because it provides second language (L2) learners essential scaffolding for acquiring an L2. Language learning is actually something that happens both inside the head of the learner and in the world in which the learner experiences the learning. The inseparability of external and internal mediation during context-dependent interaction in sociocultural SLA is in line with the argument of embodied cognition. That is, virtual immersion environments, such as Second Life (SL, a multiuser virtual environment), have drawn the attention of cross-disciplined

researchers because they make both avatar-self movement and different immersive interaction between the learner and the virtual environments possible. This speech will focus on (1) understanding the unique features of virtual worlds in providing language learners an immersive environment for embodied, social interactions via learners' avatars; and (2) how those unique features benefit learners' SLA.

THEME-BASED INVITED SPEAKER: ALT(C3)

Digital Textbooks: Trends and Standardization



Yasuhisa Tamura

Dept. Information and Communication Sciences, Sophia University, Japan

Abstract

Paper based traditional learning materials like textbooks, dictionaries and references are gradually replaced into digital ones all over the world. This trend is initiated not only by classroom teachers and learning technology researchers, but also policy makers in various countries. This digitalization of learning materials will provide more efficient learning activities, less routine works of teachers, and significant change of special needs education.

Some standardization organizations are trying to establish technical specification of the digital textbooks. Among them, IDPF (International Digital Publishing Forum) started to establish EDUPUB specification on October 2013,

which stands on a digital book format of EPUB3. It includes DAISY specification, so it solves various accessibility issues. However, because a digital book assumes to be read in a stand-alone environment, EPUB3 does not specify communication with another networked server, nor collaboration with another application program. Also, there are many education specific needs and functions of various stakeholders. EDUPUB community members are discussing to enhance EPUB3 to support these functions.

With use of these digital materials, platforms like tablet PCs, and network environment, a classroom 10 years after will be dramatically changed. This change will not only affected by the digitalization, but also new ways of teaching and learning with use of digital and open materials: active learning, flipped classroom, peer assessment and so on.

THEME-BASED INVITED SPEAKER: PTP(C7)

Cultivating design thinking in teaching with technology



Huang-Yao HONG

National Chengchi University, Taiwan

Abstract

As the demand to help students develop 21st century competencies is increasing in the knowledge-based society, the ways we used to prepare prospective teachers and support teacher professional development also need to be re-examined. To address the 21st century challenge, teachers need to be more than just efficient knowledge transmitters. They need to develop capacity to work creatively with knowledge and ideas in order to advance their teaching beyond best practice. In particular, they need design-thinking skills to help better integrate various technological, pedagogical and content knowledge into their instructional and lesson designs for cultivating 21st century learners. However, while the concept of design thinking is widely embraced by professional fields (e.g., engineering, business, and architecture), it is still new to most teachers and to the teaching profession as a whole. In this talk I will first discuss about the important role of design thinking in teaching, especially, teaching with technology. Then I will talk about ways to foster pre-service and in-service teachers' design capacity through innovative pedagogy such as knowledge building. Finally, some suggestions regarding future direction of developing design capacity in the field of teacher education and development will be made.

SPECIAL INVITED SPEAKER

Using Technology as Scaffolding for Teaching Critical Thinking in the Classroom

**Miguel NUSSBAUM**

The Computer Science Department of the School of Engineering of Pontificia Universidad Católica de Chile

Abstract

Critical thinking has become a key requirement for any list of essential 21st Century skills. The ability to think critically often determines one's level of personal development, career success and even effective participation within a community. The central problem that we address is how to operationalize critical thinking for its proper use in the classroom. We propose using technology to provide appropriate scaffolding for promoting critical thinking, helping learners to engage with their cognitive articulation and the reflective process. The scaffolding is based on the skills defined by the Delphi Report and integrates concepts of transferability and metacognition. We exemplify this with activities implemented in the classroom for third grade math and language arts, as well as high school science.

5. Panels

PANEL 1 *Can or should learning be seamless most of the time? The flip side of Mobile Seamless Learning ...*

Seamless learning is a notion that emphasizes the continuity and bridging of learning across a combination of locations, times, technologies and social settings (such as formal and informal learning, individual and group learning, and learning in physical and digital realms). Earlier work on seamless learning has focused on developing ICT-based solutions (in particular, in 1:1 or one-mobile-device-per-student settings) and teacher-facilitated pedagogies, particularly leveraging mobile technology, to enable and enhance learners' ability in switching quickly from one learning activity to another.

Therefore, seamless learning had been perceived as a special form of mobile and ubiquitous learning. Recent studies have also ventured into supporting one's learning journeys and enculturating learners in the self-directed disposition of seamless learning that may spans a person's life transitions. Thus, a new perspective of seeing seamless learning as a learning notion on its own right (with mobile and cloud computing as possible technological tools to support it) has been developed.

As an evolving area of research and practice, the landscape of seamless learning will continue to be shaped and reshaped by academics and practitioners. This panel will gather scholars from various countries to explore the provocative questions of should learning be seamless all the time, and how far we are we in understanding and designing for seamless learning – with the support of mobile technologies. Is there a flip side to too much focus on seamless learning? Should learning be continuous and technology supported all the time? What do we mean by continuous?

Implications to the advancements of seamless learning based on the explorations to these questions will then be elicited, thus promoting a dialogue among the panellists and the audience on the future directions of seamless learning.”

MODERAT

OR

Lung-Hsiang WONG, Nanyang Technological University, Singapore

PANELISTS

Gwo-Jen HWANG, National Taiwan University of Science and Technology,
Taiwan

Jari LARU, University of Oulu, Finland

Chee-Kit LOOI, Nanyang Technological University, Singapore

Marcelo MILRAD, Linneaus University, Sweden

Hiroaki OGATA, Kyushu University, Japan

Hyo-Jeong SO, Pohang University of Science and Technology, South Korea

Marcus SPECHT, The Open University of the Netherlands, the Netherlands

PANEL 2 *Innovative Programs and National Policy of ICT in Education in the Asia-Pacific Region: Looking Back and Moving Forward*

There has been a rapid growth in the use of ICT in education in the Asia-Pacific region in recent years. Various parties, including academics, governments, non-profit organizations, the private sector and teaching groups in many parts of the Asia-Pacific are currently investing considerable efforts and financial resources in support of large-scale innovative programs, and the planning of master plans and policies for the scalable and sustainable integration of ICT in education. However, the different cultural and socio-economic backgrounds of these areas may require different rationales, goals, foci, programs and policies with regard to this.

Nine senior academic researchers situated in the Asia-Pacific region (including Hong Kong, Taiwan, Singapore, Japan, Malaysia, Indonesia and India) will serve as panelists to share details of innovative programs, policies and regulations with regard to ICT in K-12 and tertiary education in their respective countries and regions, and provide insights based on their experiences and the implications of these.

The panel will conclude with an open discussion that invites researchers, policy-makers, practitioners and graduate students to exchange ideas on the forming, implementation and evaluation of innovative programs and policies for the greater use of ICT in education in a scalable and sustainable manner, and to share professional insights into the future directions of ICT in education, both in the Asia-Pacific region and beyond.

CHAIR Fu-Yun YU, National Cheng Kung University, Taiwan

PANELISTS

Tak-Wai CHAN, National Central University, Taiwan

Hirashima TSUKASA, Hiroshima University, Japan

Ronghuai HUANG, Beijing Normal University, China

Sridhar IYER, Indian Institute of Technology Bombay, India

Siu Cheung KONG, The Hong Kong Institute of Education, Hong Kong

Chee Kit LOOI, Nanyang Technological University, Singapore

Hiroaki OGATA, Kyushu University, Japan

Gunawan SURYOPUTRO, University of Muhammadiyah Prof. Dr. HAMKA, Indonesia

Lung Hsiang WONG, Nanyang Technological University, Singapore

Su Luan WONG, Universiti Putra Malaysia, Malaysia

6. Interactive Event

Event 1 *Let's try SCROLL (ubiquitous learning log system) for seamless learning analytics*

In this event, we will demonstrate a ubiquitous learning log system called SCROLL (System for Capturing and Reminding of Learning Log). Ubiquitous Learning Log (ULL) is defined as a digital record of what learners have learned in the daily life using ubiquitous technologies. It allows learners to log their learning experiences with photos, audios, videos, location, and sensor data, and to share and to reuse ULL with others. Also the organizers will discuss how we can use SCROLL in the participants' courses for seamless and flipped learning, collaborative learning, and learning analytics. So the participants should bring their own notebook PC, smartphones, or tablets to try the SCROLL system.

EVENT ORGANIZER

Hiroaki OGATA, Kyushu University, Japan
Kousuke MOURI, Kyushu University, Japan
Songran LIU, Tokushima University, Japan
Noriko UOSAKI, Osaka University, Japan

Event 2 *Active Learning Practicum for Trust Building in Team-Based Learning with Empathy*

This event is to make participants submerged into the first-hand win-win approach for the advanced communication for trust building as well as consensus building in terms of empathy in the team-based learning (henceforth, TBL), which is based on the concept of social constructivism with heads-on and hands-on practices. In the team based learning, it is usually disregarded or overlooked that the essence of TBL is fundamentally initiated from the trust building. Thus, the TBL would end up with failure.

This practicum will draw the audience to the importance of the trust building that will lead to the success of the consensus building. Throughout the course, thinking tools (Smartphone APPs) for visualization will be introduced to activate team discussion.

The target audience for this event is undergraduate students through the junior faculty members, who are interested in the learning effectiveness in TBL

EVENT ORGANIZER

Tosh YAMAMOTO, Kanasai University
Maki OKUNUKI, Kansai University, Kobe Shinwa Women's University
Chiaki IWASAKI
Tagami MASANORI

Table of contents

Title	Authors	page
Distinguished Invited Speaker		
The impact of A.I. on education – Can a robot get into The University of Tokyo?	Noriko H. Arai and Takuya Matsuzaki	1034
Invited Speaker		
Using Technology as Scaffolding for Teaching Critical Thinking in the Classroom	Miguel Nussbaum, Damián Gelerstein, Martín Caceres, Rodrigo Del Rio & Pablo Chuiuminatto	1
C1: Artificial Intelligence in Education/Intelligent Tutoring System (AIED/ITS) and Adaptive Learning		
Full paper		
A Web-based Intelligent Handwriting Education System for Autonomous Learning of Bengali Characters	Nazma Khatun and Jouji Miwa	4
The Effect of Visualizing Lesson Structures in a Teacher Education Program	Toshinobu Kasai, Kazuo Nagano and Riichiro Mizoguchi	14
An Intelligent Tool to Assist Architecture Students in the Early Stages of Design	Eva Millan, Maria Victoria Belmonte, Manuela Ruiz-Montiel, Juan Gavilanes and Jose-Luis Perez De La Cruz	22
From Tutoring to Cognitive Rehabilitation: Exploiting CBM to Support Memory Training	Antonija Mitrovic, Moffat Mathews, Stellan Ohlsson, Jay Holland, Audrey McKinlay, Scott Ogden, Anthony Bracegirdle and Sam Dopping-Hepenstal	32
Ontological Descriptions of Statistical Models for Sharing Knowledge of Academic Emotions	Keiichi Muramatsu and Tatsunori Matsui	42
Scaffolding for Self-overcoming of Impasse by Using Problem Simplification	Naoya Hayashi, Tomoya Shinohara, Sho Yamamoto, Yusuke Hayashi, Tomoya Horiguchi and Tsukasa Hirashima	50
Short paper		
An Examination of Affect and its Relationship with Learning among Students using SimStudent	Michelle Banawan, Maureen Villamor, Yancy Vance Paredes, Cesar Tecson, Wilfredo Badoy, John Roy Geralde and Ma. Mercedes Rodrigo	59
An Exploratory Analysis of Confusion Among Students Using Newton’s Playground	Juan Miguel Andres, Ma. Mercedes T. Rodrigo, Jessica O. Sugay, Ryan S. Baker, Luc Paquette, Valerie J. Shute, Matthew Ventura and Matthew Small	65
Evaluation of Difficulty Estimation for Learning Materials Recommendation	Yasuo Miyoshi, Kazuhiro Suzuki, Ken-Ichi Shiota and Ryo Okamoto	71

Exploring Student Interactions with Tutorial Dialogues in a Substep-based Tutor	Myse Elmadani, Amali Weerasinghe and Antonija Mitrovic	77
Gaze Analysis and Subjective Assessment of Learners Observing the Writing Process	Yasuhisa Okazaki, Senju Noguchi and Atsushi Yoshikawa	83
Interactive Environment for Learning by Problem-Posing of Arithmetic Word Problems Solved by One-step Multiplication and Division	Sho Yamamoto, Yuki Akao, Mitsutaka Murotsu, Takehiro Kanbe, Yuta Yoshida, Kazushige Maeda, Yusuke Hayashi and Tsukasa Hirashima	89
Question Generation Using WordNet	Nguyen-Thinh Le and Niels Pinkwart	95
Understanding Differences of Eye Movements Patterns while Reading Musical Scores between Instructors and Learners to Design Learner-Centered Teaching Strategies	Katsuko Nakahira T and Muneo Kitajima	101
Poster		
A Framework of Generating Explanation for Conceptual Understanding based on 'Semantics of Constraints'	Tomoya Horiguchi, Takahito Toumoto and Tsukasa Hirashima	107
A Program Transformation Tool for Visualizing Control Structure in Graphical Representations	Chih-Yueh Chou, Pin-Cheng Liao, K. Robert Lai and Zhi-Hong Chen	110
A Students' Mutual Evaluation Method for their Reports using PageRank Algorithm	Yuanyuan Wang, Yukiko Kawai, Setsuko Miyamoto and Kazutoshi Sumiya	113
An Ontology to Model E-learning Tools, Events and Experts for their Use in Specific Contexts	Juan M. Santos, Ruben Miguez, Manuel Jose Fernandez Iglesias, Agustin Cañas Rodriguez, Manuel Caeiro Rodríguez and Luis Anido Rifon	116
Capturing Learning Attitudes through Presentation Design Activities	Kazuhisa Seta, Yuki Taniguchi and Mitsuru Ikeda	119
Feature Extraction of the Nursing Techniques from Hand Motion Data	Takeshi Matsuda, Toshiyuki Maeda and Yukie Majima	123
Inquiry-based Learning for Meta-cognitive Training in Semantic Open Learning Space	Corentin Jouault and Kazuhisa Seta	126
Learning Method for Understanding Design Policy of Object-oriented Design and its Meta-learning Support System	Tomoko Kojiri, Hiroki Ooe and Kazuhisa Seta	129
Question Type Analysis for Question-Answering Applications in Education	Yang-Yin Lee, Chih-Chieh Shao, Yen-Pin Chiu, Yong-Siang Shih, Hsin-Hsi Chen, Chieh-Jen Wang and Sen-Chia Chang	132
Revealing Students' Thinking Process in Problem-Posing Exercises: Analysis of First Sentence Selection	Nur Hasanah, Yusuke Hayashi and Tsukasa Hirashima	135
Towards an Evaluation Service for Adaptive Learning Systems	Alexander Nussbaumer, Christina M. Steiner, Eva Hillemann and Dietrich Albert	138
C2: Computer-supported Collaborative Learning (CSCL) and Learning Sciences		
Full Paper		

A Shareable Whiteboard System for Distance Collaborative Learning which Enables Instruction for Multiple Groups of Students	Yuichi Ohkawa, Kazuki Watanabe and Takashi Mitsuishi	141
Improving 10-12 Year Olds' Epistemic and Conceptual Understanding in a Computer-supported Knowledge-building Environment	Feng Lin and Carol K.K. Chan	151
Math Creation: Integrating Peer Tutoring for Facilitating the Mathematical Expression and Explanation	Euphony Fu-Yu Yang, Hercy Cheng and Tak-Wai Chan	161
Providing Knowledge-Related Partner Information in Collaborative Multimedia Learning: Isolating the Core of Cognitive Group Awareness Tools	Daniel Bodemer and Alexander Scholvien	171
The Appropriation of a Representational Tool in the Second Language Classroom	Yun Wen, Wenli Chen and Chee-Kit Looi	180
Using Content Analysis to Check Learners' Understanding of Science Concepts	Oliver Daems, Melanie Erkens, Nils Malzahn and H. Ulrich Hoppe	190
Short paper		
Assessment of Developmental Stages of Generic Skills : A Case Study	Katsuko Nakahira T, Makoto Watanabe and Muneo Kitajima	200
'Does it Make Sense' and 'What Does it Mean'?	Jon Mason	206
Fostering Change of Views of the Nature of Scientific Theories in a CSCL Environment	Pei Jung Li and Haung Yao Hong	212
MuPeT: A Framework for Enabling Multi-Perspective Problem Elaboration	Sven Manske, Jesús Omar Álvarez MÁrquez, Adam Giemza and Ulrich Hoppe	218
The Motivational Underpinnings of Using wikis for Collaborative Group Work	Ronnel King and Samuel K. W. Chu	224
Learning about Reflection Processes: An Analysis of Learners' Observation of Experts	Akio Takashima	230
Poster		
A Relationship between the Pair Effect and the Learner Characteristic at Pair Work in Computer Literacy Education	Kimiko Uchida, Yoshihiko Oya and Takashi Okuda	235
A Study on Teaching Debugging Strategies for Digital Circuit	Hong-Fa Ho and Duen-Huang Huang	238
Design of Embodied Learning in 3D Virtual Worlds for Pre-service Teachers	Young Hoan Cho, Yoon Kang Kim, Myung-Seop Kim and Mae Hyang Hwang	241
Development of Predict-Test-Revise Modeling Abilities via a self-study Learning Environment	Anura Kenkre, Sahana Murthy and Madhuri Mavinkurve	244
Evaluation of the Effectiveness of a Digital Microscope System with Tabletop Interface in a Science Class	Kazuyuki Morita, Norio Setozaki and Yusuke Morita	248
Circuitously Collaborative Learning Environment to Enhance Metacognition in Solving Mathematical Word Problem	Tama Duangnamol, Boontawee SUNTISRIVARAPORN Suntisrivaraporn, Thepchai SUPNITHI Supnithi and Mitsuru Ikeda	251

A Mathematical Model of Collaborative Learning using Differential Equations	Shinnosuke Nishi, Yasuyuki Nakamura, Koichi Yasutake and Osamu Yamakawa	254
Pre-service Teacher Existing Ideas of Using Computer-Supported for Scientific Inquiry	Jiraporn Tupsai, Jirakan Yuenyong and Chokchai Yuenyong	257
Remote Laboratory System for Technology-Enhanced Science Learning: The Design and Pilot Implementation in Undergraduate Courses	Siew Wei Tho and Yau Yuen Yeung	260
The Model Construction and Platform Development of Students' Originality Incubator System	Yunjia Xie, Jingya Chen and Weipeng Kuang	263
C3: Advanced Learning Technologies, Open Contents, and Standards		
Full paper		
A Flexible System and Data Model for the Representation and Management of PBL Scripts	Disi Wang, Yongwu Miao, Ulrich Hoppe and Mohammed Samaka	266
Algorithmic Thinking Learning Support System in Block Programming Paradigm	Mizue Kayama, Hisayoshi Kunimune, Masaaki Niimura, Masami Hashimoto and Makoto Otani	276
Learning by Posing Problems Using Illustrations Instead of Words	Takanobu Umetsu, Hikaru Eto, Tsukasa Hirashima and Akira Takeuchi	285
Structural and trend analysis of tagging as a mechanism for organizing learning resources	Ji-Lung Hsieh and Li-Chiao Chiu	293
Study on Pass-Fail Prediction for the National Radiological Technologist Examination by Discriminant Analysis Using Mock Examinations	Hiroyoshi Watanabe, Shigeru Sasaki, Shinsuke Aiko and Shigemi Sakamoto	303
Short paper		
Altruistic Behavior in a Learning Stage through Social Network	Shiang-Yi Wang, Wang-Han Li, De-Yuan Huang, Chi-Wen Huang, Su-Hang Yang and Gwo-Dong Chen	313
Analyzing Course Competencies: What can Competencies Reveal about the Curriculum?	Swapna Gottipati and Venky Shankararaman	319
Applying an Extensible Learning Support System to Learning by Problem Posing	Kiyoshi Nakabayashi and Yosuke Morimoto	325
AR based Skill Learning Support System with Velocity Adjustment of Virtual Instructor Movement	Takuya Mishima, Masaru Okamoto and Yukihiro Matsubara	331
Audio Subtitle Mapping System between Slide and Subtitles by Co-occurrence Graphs on VOD Lecture	Kohei Sakane, Nobuyuki Kobayashi, Hiromitsu Shiina and Fumio Kitagawa	337
Code Reading Environment by Visualizing both Variable's Memory Image and Target World's Status	Satoru Kogure, Ryota Fujioka, Yasuhiro Noguchi, Koichi Yamashita, Tatsuhiro Konishi and Yukihiro Itoh	343
Computer Assisted Learning based on ADDIE Instructional Development Model for Visual Impaired Students	Sasithorn Chookaew, Suppachai Howimanporn, Warin Soodkaneung, Wanida Pradubsri and Piyawat Yoothai	349

Learning Cinema Authoring System in the Classroom	Yuan-Fu Luo, Wei-Chih Lin, Tai-Yin Lin, De-Yuan Huang, Chi-Wen Huang and Gwo-Dong Chen	355
Presentation Reconstruction Method for Peer Review Support in Presentation Rehearsal	Akihiro Tanikawa, Ryo Okamoto and Akihiro Kashihara	361
Probabilistic Question Selection Approach for AR-based Inorganic Chemistry Learning Support System	Masaru Okamoto, Ryoya Sumida and Yukihiko Matsubara	367
The effect of discourse analysis activity with KBDeX on students' understanding about collaborative learning	Sayaka Tohyama, Yoshiaki Matsuzawa and Hajime Shirouzu	373
The Impact of Using 3D Animation in Students' Spatial Ability	Jiong Guo, Yuhui Ma and He Gao	379
Poster		
Development and Evaluation of a User Adaptive Kanji Learning System Using Computer Graphics	Kotaro Matsushita, Takahiro Kurumagawa, Natsumi Nemoto, Takuya Sakiyama, Hideo Suzuki, Kenneth J.Mackin, Yasuo Nagai and Eiji Nunohiro	385
Effective eLearning through MOOC: Lessons learnt in selecting a MOOC	Dilrukshi Gamage, Indika Perera and Shantha Fernando	388
Learning by "Search & Log"	Chengjiu Yin, Brendan Flanagan and Sachio Hirokawa	391
On Using Mutation Testing for Teaching Programming to Novice Programmers	Rafael Oliveira, Lucas Oliveira, Bruno Cafeo and Vinicius Durelli	394
Search System for Audio and Video Lecture Content Using Auto-Recognized Transcripts	Yosuke Morimoto, Kumiko Aoki, Kouichi Katsurada, Genki Ishihara, Yurie Iribe and Tsuneo Nitta	397
The Effect of Film Scenarios and Annotation Tools on Video Learning	Dai-Yi Wang and Ting-Yi Chang	400
C4: Classroom, Ubiquitous, and Mobile Technologies Enhanced Learning (CUMTEL)		
Full paper		
A systematic review of assessment methods in mobile computer-supported collaborative learning (mCSCL)	Yanjie Song	403
Designing and Developing Interactive Video Experiences for Supporting M-Learning	Dan Kohen-Vacs, Marc Jansen, Marcelo Milrad and Miky Ronen	413
Feeling at Home from the First Day: Using Mobile Location-Based Games for Welcoming New Students	Miky Ronen, Ronen Hammer and Dan Kohen-Vacs	423
How Do Students Progress in a Mobilized Inquiry Science Curriculum	Chee-Kit Looi, Daner Sun, Wenting Xie, Chun Ming Tan and Siti Hajar	432
Maparin: Creating a Friendly and Adaptable Learning Scenario for Foreign Students in Taiwan	Wei-Tung Tang and Shelley Shwu-Ching Young	442
Schema Formulation with Schema Priming Test in Elementary Arithmetic class in Japan	Kazuhisa Seta, Akira Shimazoe, Kanetaka Mori and Masahiko Okamoto	451

Visualization for Analyzing Ubiquitous Learning Logs	Kousuke Mouri, Hiroaki Ogata, Noriko Uosaki and Songran Liu	461
Short paper		
A Context-aware Dynamical Learning Environment for Multiple Objectives	Min Chen, Feng-Kuang Chiang and Sheng-Quan Yu	471
A Pilot Study Comparing Secondary School Students' Perception of Smart Classrooms in Hong Kong and Beijing	Baoping Li and Siu Cheung Kong	477
A Study of Student Behavior in Classroom Response Systems	Kozo Mizutani	483
An Approach to Electronic Textbook Linking Chemical Experiment - Esterification of Acetic Acid and Ethanol -	Akira Ikuo, Yusuke Yoshinaga and Haruo Ogawa	489
An Online Course for Active Participation and Interactive Learning:An Exploratory Study	Qiyun Wang and Wenhao Li	494
Checkpoints for Integration of a One-to-One Tablet Configuration in a School Learning Environment	Johannes Zylka and Wolfgang Mueller	499
CHiLOs: A New Virtual Learning Environment for Large Scale Online Courses	Masumi Hori, Seishi Ono, Shinzo Kobayashi, Kazutsuna Yamaji and Toshihiro Kita	505
Mobile 2.0 learning: Empowering mobile learning with socialized context sharing	Ming-Chi Liu, Yen-Ning Su, Nian-Shing Chen and Yueh-Min Huang	511
Enabling a Positive First Year Experience in Higher Education through Social Media and Mobile Technologies	Shaun Nykvist, Michelle Mukherjee and Kelli McGraw	516
Implementing and Validating a Mobile Learning Scenario Using Contextualized Learning Objects	Alisa Sotsenko, Marc Jansen and Marcelo Milrad	522
Learning Log Dashboard: To See Your Own Progress	Erdenesaikhan Lkhagvasuren, Kenji Matsuura, Kousuke Mouri and Hiroaki Ogata	528
Relationship of Ubiquitous Technology Usage with Technology Competency	Rosnaini Mahmud, Muliati Sedek, Habibah Ab. Jalil and Shafee Mohd Daud	533
Seamless Flipped Classroom Using SCROLL in CALL Class	Noriko Uosaki, Hiroaki Ogata and Kousuke Mouri	539
Supporting E-Learning in Computer-poor Environments by Combining OER, Cloud Services and Mobile Learning	Simon N. Mwendia, Sven Manske and H.Ulrich Hoppe	545
Poster		
Applying POE Framework in a Simulation System for Facilitating Physics Learning with Tablet PCs	Chia-Ching Lin, Fo-Jui Chen and Chen-Chung Liu	551
Authoring Augmented Reality as Situated Multimedia	Marc Ericson Santos, Jayzon Ty, Arno in Wolde Luebke, Ma. Mercedes Rodrigo, Takafumi Taketomi, Goshiro Yamamoto, Christian Sandor and Hirokazu Kato	554
Behavioral Analysis of Learners Using Smart Devices in an Indirect Learning System	Shigeki Ohira	557
Development of a Mobile Visualization Application for Constructivist Learning and Assessment in Science	Hsin-Yi Chang, Yuan-Tse Yu, Jung-Yi Hung and Kao-Chi Hsu	560

Educational Affordances of Smart Learning Applications in Science Education	Young Hoan Cho, Hyunyoung Lee, Mirye Ok, Namsoo Shin, Eun Jung Koh, Changyoun Lee and Dae Hong Jeong	563
Evaluation of Using a Tablet Device for a School Trip	Norio Setozaki, Mai Okuda and Yusuke Morita	566
Features of Creating Flash Card Materials for Reflecting on Learned Contents	Shin Kurata	569
Research on Learning Support Using a Digital Pen	Yukiya Ishida and Junichi Imai	572
Smart Phone based Data Collecting System for Analyzing Learning Behaviors	Chengjiu Yin, Fumiya Okubo, Atsushi Shimada, Kentaro Kojima, Masanori Yamada, Naomi Fujimura and Hiroaki Ogata	575
C5: Digital Game and Digital Toy Enhanced Learning and Society (GTEL&S)		
Full paper		
Emergent Practices and Distributed Emotions in Educational Game Play	Beaumie Kim and Wing Ho	578
Investigating Factors Affecting Conceptual Learning Progression when Playing Digital Game-based Inquiry Learning for Energy Education	Patcharin Panjaburee, Ugyen Dorji and Niwat Srisawasdi	588
Revised Computer Game Attitude Scale	Maiga Chang, Rita Kuo and Eric Zhi-Feng Liu	598
Why Are Schools Reluctant to Bring Higher-order Thinking Games to Classrooms?	Mingfong Jan	608
Short paper		
An RPG Pattern for Ethical Gameplay in MAGNITUDE	Didin Wahyudin and Shinobu Hasegawa	618
Aesthetic Design for Learning with Games	Diali Gupta and Beaumie Kim	624
Enhancing Motivation in Disaster Prevention Learning with Perceptual and Semantic Gaming	Koji Tanaka, Tatsuto Hirai, Mitsuru Ikeda and Masahiro Hori	630
Game-based APP in Teaching Newton's Three Laws of Motion for High School Students	Hsin-Yih Shyu and Yu-Hur Chou	636
Gamification in Academia Practice – What Motivate Users Most	Ming-Shiou Kuo, Tsung-Yen Chuang, Ting-Chieh Chuang, Po-Yu Chen and Hsin-Chih Lin	641
Enhancing Children's Numeracy & Te Reo Skills using Computer Games	Kalpana Nand, Nilufar Baghaei and John Casey	647
Learning English Words via Visual Media using Tablet PCs	Kaoru Sumi and Ayaka Kazuhara	653
On the Design of Embodiment-based Gamification Activities for Learning Fundamental Projectile Motion	Shih-Chieh Wang, I-Chun Hung, Li-Chun Lin and Nian-Shing Chen	659
SHIVA: Virtual Sculpting and 3D Printing for Disabled Children	Leigh McLoughlin, Oleg Fryazinov, Mark Moseley, Mathieu Sanchez, Valery Adzheiv, Peter Comminos and Alexander Pasko	665
Poster		

Inferred Learning Strategy in Two-User-One-Computer Environment Study from Cognitive Style Perspective	Jo-Yu Huang, Ben Chang, Yi-Jie Lin and Fang-Chen Lu	671
Can Time Perception Be Affected by Interactive Comics?	Xinwei Wang, Jun Hu, Bart Hengeveld and Matthias Rauterberg	674
Subjective Evaluation of Stereoscopic View in Immersive Projection Display	Kikuo Asai	677
Application of Tangible Animal Companions in Traditional Chinese Character Learning	Zhi-Hong Chen	680
C6: Technology Enhanced Language Learning (TELL)		
Full paper		
An Investigation of Personality Trait on Asynchronous Computer-Mediated Communication Supporting Speaking Performance	Mei-Jen Shih and Jie Chi Yang	683
Comparison of Kit-Build and Scratch-Build Concept Mapping Methods on EFL Reading Comprehension	Mohammad Alkhateeb, Yusuke Hayashi, Taha Rajab and Tsukasa Hirashima	691
Evaluating Augmented Reality for Situated Vocabulary Learning	Marc Ericson Santos, Arno In Wolde Luebke, Takafumi Taketomi, Goshiro Yamamoto, Ma. Mercedes Rodrigo, Christian Sandor and Hirokazu Kato	701
System Design for Academic Listening of Second Language Based on Strategy Object Mashups Approach	Hangyu Li and Shinobu Hasegawa	711
Short paper		
An Initial Finding from Scaffolding the Cross Campus Commenting with a Web 2.0 Resource	Gloria Shu Mei Chwo and Sylvia Wen Lin Chu	721
Development of Multimodal Tool to Support Second Language Classroom – Case of Japanese	Nushrat Jahan Khan and Hideo Joho	727
Enhancing English Pronunciation with Windows Speech Recognition Training: A Preliminary Study	Hui-Hsien Feng and Ying-Hsueh Cheng	733
Exploring the Value of Multimedia Messaging Service for Learning English Reading: Using LINE as an Example	Pei-Hsun Emma Liu, Ruey-S Shieh and Wen-Chi Vivian Wu	739
Gender Differences in Flow State in an English Learning Environment Achievement System	Benazir Quadir and Jie Chi Yang	744
Multimedia Development of English Vocabulary Learning in Primary School	Syaiful Rohim and Lina Yulinda	750
Online Manga and Anime in Promoting Language Learning and Literacy Practices	Abu Bakar Razali	756
Online Popular Culture in Language Learning: Reading and Writing Online Fanfiction	Abu Bakar Razali	762

Pedagogical Methods in Web-based Language Teaching	Rieko Hattori-Saito, Masako Hayakawa Thor, Yoko Mizufune, Hiroko Inose, Mario Antonio Lopes Cordero and Alex Pruth	768
Knowledge Features of Peer Response Process	Siou-Lan Wang, Calvin C. Y. Liao, Chih-Yuan Shih and Tak-Wai Chan	773
Real-time Feedback Systems in a Foreign Language Teaching: A Case of Presentation Course	Yuichi Ono, Manabu Ishihara, Sachio Hirokawa and Mitsuo Yamashiro	779
Sauce for the Goose? Testing SVECTAT in Japan and Taiwan	Mark Elwell, Tsun-Ju Lin, Steven Cook, Carlos Martin, Jean-Christophe Terrillon and Yu-Ju Lan	785
Situational Sets Effect on Role-Play Game Supported English for Specific Purposes Vocabulary Acquisition	Fang-Chen Lu and Ben Chang	790
Understanding English Language Learners' Experiences and Perceptions of Mobile Assisted Vocabulary Learning	Lu-Yu Yeh, Hsiu-Ting Hung and Janice Liao	796
Using an Online Social Network Site as a Learning Community to Enhance EFL Learners' Cultural Awareness	Ming-Yi Chen Hsieh, Wen-Chi Vivian Wu, Yu-Chuan Joni Chao and Chun-Lan Chen	801
Poster		
A Tagging Editor for Learner Corpora Annotation and Error Analysis	Lung-Hao Lee, Kuei-Ching Lee, Li-Ping Chang, Yuen-Hsien Tseng, Liang-Chih Yu and Hsin-Hsi Chen	806
Developing and Evaluating a Test Generation Module to Support Personalized Phoneme-based Training	Yaheng Zou, Harumi Kashiwagi, Yi Sun, Kazuhiro Ohtsuki and Min Kang	809
Enhancing EFL Learning of Elementary School Students through Human-Robot Interaction	Rong-Jyue Wang, Wen-Chi Vivian Wu and Yi-Chun Liu	812
Essay Development Schemata to Support English Composition	Hidenobu Kunichika, Yuki Ikeda and Akira Takeuchi	815
Fostering College Students' Reading Comprehension with Online Annotations	Hui-Chin Yeh, Yu-Hsin Chiang, Yu-Fen Yang and Janice Liao	818
Game-based Mobile Learning Companion for L2 Vocabulary Acquisition	Fang-Chuan Ou Yang, Yu-Mei Yang and Wen-Chi Vivian Wu	821
Online Peer Feedback and Learner Autonomy in EFL Writing Class	Silih Warni and Gunawan Suryoputro	824
Survey on Japanese University Students' Learning Experiences with ICT and Open Sources for International Collaboration	Yoshiko Goda, Masanori Yamada, Yumi Ishige and Junko Handa	827
Teacher Learning in a Virtual Field Experience	Hui-Chin Yeh, Yu-Fen Yang and Shih-hsien Yang	830
The Relationships among Learners' Backgrounds, Metacognitive Vocabulary Learning Strategy Awareness and Mobile Vocabulary Learning Readiness	Chih-Cheng Lin and De-Yan Wu	833
Topic: Using Popular Mobile Application Software to Increase Learner Motivation	Pin-Hsiang Natalie Wu and Michelle Kawamura	836

C7: Practice-driven Research, Teacher Professional Development and Policy of ICT in Education (PTP)

Full paper		
An Ecological Model for Scaling and Translation: Maximizing the impact of Research and Development Interventions	David Hung, Longkai Wu and Lung Hsiang Wong	839
An Educational Practice Using a Code Reading Support Environment for Understanding Nested Loop	Koichi Yamashita, Takamasa Nagao, Satoru Kogure, Yasuhiro Noguchi, Tatsuhiro Konishi and Yukihiro Itoh	848
Characterizing TPACK Transformations in the Design of School-Based Pedagogical Change	Joyce Hwee Ling Koh and Ching Sing Chai	858
Professional Development of Teachers in a MOOC	Niklas Karlsson, Anna-Lena Godhe, Linda Bradley and Berner Lindström	868
Teachers' Perceptions of E-Learning in Malaysian Secondary Schools	Mei Lick Cheok and Su Luan Wong	878
Unpacking the Researcher-Teacher Co-Design Process of a Seamless Language Learning Environment with the TPACK Framework	Lung Hsiang Wong, Ching Sing Chai, Ronnel King, Xujuan Zhang and Guat Poh Aw	886
Short paper		
A2I: A Model for Teacher Training in Constructive Alignment for Use of ICT in Engineering Education	Jayakrishnan Warriem, Sahana Murrthy and Sridhar Iyer	896
Analytical Evaluation of Technology Acceptance in Teachers Training of Primary Mathematics Education in Hong Kong: A Preliminary Study	Gary K. W. Wong and Ho Yin Cheung	903
Assessing Computer Attitudes: Does It Matter for Teacher Education in Developing Countries?	Su Luan Wong	909
Construction of Web Communication System to Support Young Teachers' Training	Takeshi Morishita, Hiroo Tsukamoto, Toshiro Kikunaga, Takashi Sakoda, Ikufumi Wakisaka and Satoshi Tsuchida	915
Detailed User Relation Visualization on Moodle	Ping Li and Siu Cheung Kong	921
Development of Association Recommend Function for a Cross-curricular Subject Education Database as an Example in Disaster Prevention Education	Hiroyuki Muramatsu, Hideaki Shimada, Shingo Kumagaya and Satoshi Tanaka	927
Digital Storytelling for Professional Socialization Through Cartooning Preservice Working Experience: A Case Study	Toshio Mochizuki and Takeshi Kitazawa	933
Do They Keep Technology in Mind? An Implementation of TPACK-oriented Science Teacher Program for Science Degree-graduated Students	Niwat Srisawasdi and Patcharin Panjaburee	939
Evaluation of Three-Site Multipoint Distance Learning using High-Definition "HyperMirror"	Taiichiro Okubayashi, Akiko Nakazawa, Hideki Mori, Takanori Maesako and Osamu Morikawa	945
Information Literacy Skills of Pre-service Teachers: A Case Study	William Ko-Wai Tang and Morris Siu-Yung Jong	951
Interactive Whiteboards in Classrooms: Debates, Issues, and Impeding Factors	Mas Nida Md Khambari, Dawnene Hassett, Michael Thomas and Su Luan Wong	957

Learning Design Framework for Constructive Strategic Alignment with Visualizations	Gargi Banerjee, Mrinal Patwardhan and Sahana Murthy	963
Practice of the Programming Education Using Arduino and the Class Support System	Kazuo Tenra	969
Predicting the Perceived Usefulness of eBook among Mathematics Teachers	Azlin Abd Jalal, Ahmad Fauzi Mohd Ayub and Rohani Ahmad Tarmizi	975
Strategies for Improving Learning Performance by Using Crowdsourcing and Flipped Classroom	Chunyan Yu, Zhihong Xu, Guilin Chen and Jinghua Guo	981
Students' Conceptions of and Approaches to Knowledge Building: A Phenomenographic Method	Pei-Shan Tsai, Ching Sing Chai, Joyce Hwee Ling Koh, Nurul Huda Muhamad Jailani and Angela Lay Hong Koh	987
Influence of ICT-Supported Learning Environment Perceptions, Academic Ability, and Prior Educational Experience on Approaches to Learning for Accounting in Malaysian Secondary Schools	Boon See Tan and Su Luan Wong	993
The Undergraduates' Attitude towards the Use of Asynchronous Online Discussion (AOD)	Noor Farah Shahida Mohd Haris, Rosnaini Mahmud and Wong Su Luan	999
University Teachers' Needs of Support for Designing and Preparation of Courses: A Focus on Differences by Academic Discipline and Rank	Fumiko Konno and Takashi Mitsuishi	1005
Using a PBL Authoring Tool to Train Teachers in Designing an Online PBL Unit	Yongwu Miao, Mohammed Samaka, Disi Wang, Zeyad Ali and Michael Romanowski	1011
Using the ePortfolio System to Foster Student Self-regulated Learning	Lap Nguyen and Mitsuru Ikeda	1017
Poster		
Application of GIS: A New Tool to Explore the Administration and Life of the Local Officers of Tang-Song Dynasty	Hsin-Chun Liu, Pei-Lun Lee and Min-Lan Fan	1023
Practical Use of 3D Images in the Interactive Slideshow to Study Traditional Buildings	Soichiro Kawamura and Hiroyuki Shimada	1025
The Development of Scenario Game Teaching Material for the Learning of Power Networks at Technology Education in Junior High School	Hiroyuki Muramatsu, Ryoichi Kitazaki, Hiroyoshi Nishizawa, Kiyoshi TANAKA, Saeed Ramezanjamaat and Phillip Cardon	1028
The Flipped Classroom: Factors of Self-regulated Learning Affecting Students' Learning Effects	Kuo-Yu Liu	1031

Using Technology as Scaffolding for Teaching Critical Thinking in the Classroom

Miguel NUSSBAUM*, Damián GELERSTEIN, Martín CÁCERES, Rodrigo DEL RIO & Pablo CHIUMINATTO

Pontificia Universidad Católica de Chile, Chile

*mn@ing.puc.cl

Extended Abstract

Critical Thinking Skills

Critical thinking has become a key requirement for any list of essential 21st Century skills (Griffin, McGaw & Care, 2012; Greenhill, 2009). The ability to think critically often determines one's level of personal development, career success and even effective participation within a community (Nussbaum, 2006). In the words of Marques (2012), critical thinking has become a prerequisite for survival. The shift towards experience-based learning has left little room for reflection. Prensky (2001) acknowledges that the most interesting challenge of teaching digital natives is to find ways to include critical thinking in their learning.

There is a considerable amount of literature on critical thinking (Kennedy, Fisher & Ennis, 1991; Pithers & Soden, 2000; Lai, 2011; Dwyer, 2014). However, this has led the concept to become dispersed, with a number of views that fail to converge. There is also no view put forward on how to operationalize critical thinking in the classroom. In order to do so, integrated processes for transference and assessment are required (Halpern, 2003).

Therefore, the central problem that we address is how to operationalize critical thinking for its proper use in the classroom.

Not all mental events can be considered as critical thinking. One way to conceptualize critical thinking has been to define it in relation to higher-order thinking skills, such as analyzing, interpreting and explaining (Dwyer, 2014). In an attempt to homogenize critical thinking, Facione (1990) defines it as "purposeful, self-regulatory judgment which results in interpretation, analysis, evaluation, and inference, as well as explanation of the evidential, conceptual, methodological, criteriological, or contextual considerations upon which that judgment is based". It is important to note that this definition includes precisely those skills which experts consider as being fundamental to any critical process.

Transference between domains is one of the greatest challenges faced when implementing critical thinking in education (Halpern, 1998). Whoever learns a skill must be capable of using it in contexts other than the one in which it was originally learned (Housen, 2012). Transference demands that any concept of critical thinking find a balance between the generalization of the skills involved and the learning of these skills in specific contexts (Facione, 1990).

Van Gelder (2005) suggests that the difficulty of transference with critical thinking stems precisely from its generalized nature. The fact that critical thinking skills can be applied to such varied domains, contents and contexts means that there is a very good chance of not applying the correct principle. He therefore recommends teaching explicit procedures for each domain and making these general enough to transfer across domains. In order to do so, he refers to Halpern's (2003) model for teaching critical thinking. As well as meeting the above requirements, Halpern's model also includes metacognitive monitoring. By monitoring the thought process, the quality of this process improves, i.e. the correct procedures are applied to the appropriate contexts. This is achieved by distinguishing between mechanical application of the rules and inferential comprehension, by which we mean identifying the inferential relationships between the elements of an activity (Mulnix, 2012).

Scaffolding model

We propose using technology to provide a scaffolded framework for teaching critical thinking in the classroom. Providing appropriate scaffolding is fundamental for promoting critical thinking (Kim

et al., 2013), while technological support helps learners engage with their cognitive articulation and the reflective process (Lajoie et al., 2001). The scaffolding is designed to support the assessment and teaching of critical thinking in the classroom. Furthermore, it also aims to allow students to exercise the skills explicitly (Halpern, 2003) and help the teacher monitor how the skills are learned.

A learning environment must support active engagement in the learning process (Dawson, 2000); provide adequate scaffolding and opportunities for practice (Macknish, 2011); and engage students in higher-order thinking tasks such as questioning, analysis, synthesis, and evaluation through instructional strategies such as small-group activities, simulations, and case studies (Meyers & Jones, 1993).

The scaffolding is based on the skills defined by the Delphi Report (Facione, 1990), and integrates the concepts of transferability and metacognition (Halpern, 2003). The proposed model consists of sequential scaffolding for solving problems, in which learners elaborate thoughts (interpretation), explain results (explanation), evaluate solutions (metacognition), explore and clarify inconsistencies and knowledge gaps (analysis and inference), and thus benefit from the cognitive restructuring that underpins cognitive change (Garside, 1996). The sequence consecutively intersperses higher-order thinking skills (analysis, interpretation and inference) with the metacognitive process (evaluation and self-assessment), produced by explicitly forming arguments based on questions about the problem solving process itself.

As an example of such a sequence, we can use the case of teaching problem solving for division in 3rd grade. The activity begins by posing the problem, in this case: "I have six bananas and 3 boxes. If I divide them equally, how many bananas would be in each box?". In order to put into practice the first step in the sequence, i.e., interpreting, the student must graphically depict the number of elements needed to solve this problem, in this case 6 bananas and 3 boxes. Once the problem has been interpreted, and in order to explicitly practice the skill of evaluating, an erroneous interpretation of the problem is then presented. For this particular exercise, an uneven distribution of bananas in each box is shown. This step can only be completed if the student is able to identify the mistake and explain it explicitly by forming an argument, thus showing they are capable of metacognitive monitoring. The following step is to solve the problem by correcting the mistake, where the student must apply the skills of analyzing and inferring. The solution to the problem is then interpreted, again putting into practice the skills of interpreting and evaluating. In order to do so, the student is shown an incorrect interpretation of the operation that was carried out. In this case, the erroneous interpretation would be: "We can summarize this operation as follows: $6:3 = 3$ ". The student must first identify the mistake, then explain and correct it. In each step, if the student makes a mistake, immediate feedback is given so that they can reflect upon their error and make the necessary corrections.

It is worth noting that this process requires a high level of interaction with the activity from the student. Technology therefore plays a vital role in the proposed problem solving process. This technological support also allows each student to advance at their own pace according to the difficulties they face, as well as making them pass through every step. Furthermore, appropriate feedback is given at each step depending on the student's performance. By doing so, the teacher can focus on monitoring the activity and helping those students who struggle the most.

Conclusion

We have proposed a scaffolded framework for teaching critical thinking using a sequence for solving problems where both higher-order thinking skills and the metacognitive process are practiced explicitly. This proposal is far from being a recipe for solving problems; by requiring a metacognitive process at each step the students are constantly forced to reflect, making it difficult for the process to become mechanical. This therefore allows the process to be generalized and applied to different domains.

Acknowledgements

This research is supported by the Center For Research On Educational Policy And Practice, CIE01-CONICYT

References

- Dawson, R. E. (2000). Critical thinking, scientific thinking, and everyday thinking: Metacognition about cognition. *Academic Exchange*, 4, 76–83.
- Dwyer, CP, Hogan, MJ, & Stewart, I. (2014). An integrated critical thinking framework for the 21st century. *Thinking Skills and Creativity*, 12 (2014), pp. 43–52.
- Facione, P. A. (1990). *Critical Thinking: A Statement of Expert Consensus for Purposes of Educational Assessment and In-struction. Research Findings and Recommendations*. Retrieved June 06, 2014, from, http://assessment.aas.duke.edu/documents/Delphi_Report.pdf
- Garside, C. (1996). Look who's talking: A comparison of lecture and group discussion teaching strategies in developing critical thinking skills. *Communication Education*, 45, 212–227.
- Greenhill, (2009). P21 framework definitions document, Retrieved June 06, 2014, from, http://www.21stcenturyskills.org/documents/p21_framework_definitions_052909.pdf.
- Griffin, P., McGaw, B., & Care, E. (2012). *Assessment and Teaching of 21st Century Skills*. New York: Springer.
- Halpern, D.(1998). Teaching Critical Thinking for Transfer Across Domains. *American Psychologist*, vol.53, no. 4, pp. 449-455.
- Halpern, D. (2003). *Thought and knowledge: An introduction to critical thinking* (4th ed.). Mahwah, NJ: Lawrence Erlbaum Associates.
- Housen A. (2012). Aesthetic thought, critical thinking and transfer. *Arts and Learning Research Journal*, 18:99–132.
- Kennedy, Fisher & Ennis. (1991). Critical thinking: literature review and needed research. In L. Idol, & B. Fly Jones (Eds.), *Educational values and cognitive instruction: Implications for reform* (pp. 11–40). Hillsdale, NJ: Lawrence Erlbaum.
- Kim, K., Sharma, P., Land, S.M., Furlong, K.S. (2013). Effects of Active Learning on Enhancing Student Critical Thinking in an Undergraduate General Science Course. *Innov High Educ* 38:223–235.
- Lai, . (2011). *Critical Thinking: A Literature Review*. Research Report. Pearson education. Retrieved 6.6.14, <http://www.pearsonassessments.com/hai/images/tmrs/CriticalThinkingReviewFINAL.pdf>.
- Lajoie, S. P., Lavigne, N. C., Guerrero, C., & Munsie, S. (2001). Constructing knowledge in the context of BioWorld. *Instructional Science*, 29, 155–186.
- Macknish, C.F. (2011). Understanding Critical Reading in an ESL Class in Singapore. *TESOL Journal* Volume 2, Issue 4, pp. 444–472.
- Marques, J. F. (2012). Moving from trance to think: why we need to polish our critical thinking skills, *International Journal of Leadership Studies*, Vol. 7 Iss. 1, 2012, 87-95.
- Mayer, R. E. (1998). Cognitive, metacognitive, and motivational aspects of problem solving. *Instructional Science*, 26(1-2), 49-63.

A Web-based Intelligent Handwriting Education System for Autonomous Learning of Bengali Characters

NAZMA Khatun^{a*}, Jouji MIWA^a

^a*Department of Electrical Engineering and Computer Science,
Graduate School of Engineering, Iwate University, Japan*

*nazmababu@gmail.com

Abstract: In this paper, we describe a prototype of web-based intelligent handwriting education system for autonomous learning of Bengali characters. Bengali language is used by more than 211 million people of India and Bangladesh. Due to the socio-economical limitation, all of the population does not have the chance to go to school. This research project was aimed to develop an intelligent Bengali handwriting education system. As an intelligent tutor, the system can automatically check the handwriting errors, such as stroke production errors, stroke sequence errors, stroke relationship errors and immediately provide a feedback to the students to correct themselves. Our proposed system can be accessed from smartphone or iPhone that allows students to do practice their Bengali handwriting at anytime and anywhere. Bengali is a multi-stroke input characters with extremely long cursive shaped where it has stroke order variability and stroke direction variability. Due to this structural limitation, recognition speed is a crucial issue to apply traditional online handwriting recognition algorithm for Bengali language learning. In this work, we have adopted hierarchical recognition approach to improve the recognition speed that makes our system adaptable for web-based language learning. We applied writing speed free recognition methodology together with hierarchical recognition algorithm. It ensured the learning of all aged population, especially for children and older national. The experimental results showed that our proposed hierarchical recognition algorithm can provide higher accuracy than traditional multi-stroke recognition algorithm with more writing variability.

Keywords: Intelligent handwriting education system, Hierarchical recognition, Handwriting errors, Automatic stroke error detection, Modified Dynamic Programming Matching (DPM), JSP (JavaServer Page), WWW client-server interface.

1. Introduction

1.1 Motivation and our contribution

Literacy in Bangladesh is a key for socio-economic progress, and the Bengali literacy rate grew to 55% in 2010 from 5.6% at the end of British rule in 1947. Despite government programs, the literacy rate was improved very sluggishly (only about 10 times within 60 years) [1]. Because of socio-economical limitation, all of the population, especially children and older national, do not have the chance to go to school. Although government has various educational activities, the number of school was not adequate yet. Considering this educational background, traditional handwriting teaching system is not enough to improve the Bengali literacy rate at 100%. Because, in the traditional handwriting teaching system, the teacher must write a Bengali character on the blackboard and the students should rewrite the handwritten character on their copy books. After that, the teacher tries to check the handwriting errors in the student's notebooks and provides a feedback in the next time, because it's impossible for a teacher to verify and check every student's handwriting in the limited time of the lesson. This system can be successfully acquired only though practice regularly and for long periods. In this context, Z. Hu et al. [2] define three drawbacks of the traditional education, such as time-consumption, faultiness, teacher-oriented. In addition, these techniques have many more drawbacks in aspects of socio-economical view point. It motivated us to develop web-based intelligent handwriting education system for autonomous learning of Bengali characters. The learning process becomes much more

effective, if the handwritten character is checked just after the students have finished their handwriting. On the other hand, the students can learn without the teacher supervision and they can correct the committed errors. Also, the students can repeat the same exercise several times to speed up the learning process. In this research project, we are aiming to develop a web-based (iPhone/smartphone or computer browser) intelligent handwriting education system that can ensure the learning of Bengali characters for those population, especially children or older national, who do not have chance to go to school. Thus, 100% literacy improvement can be established within a very short period. To the best of our knowledge, this is a pioneering attempt for the development of web-based intelligent handwriting education system to improve Bengali literacy.

Bengali is a multi-stroke input characters with extremely long cursive shaped where it has stroke order variability and stroke direction variability. The difficulty in online recognition of handwritten Bengali characters arises from the facts that this is a moderately large symbol set, shapes are extremely cursive even when written separately. In addition, there exist quite a few group of almost similar shape characters in their handwritten format. Fundamentally, multi-stroke recognition algorithm results very slow recognition speed in case of long cursive characters. For the structural limitation of Bengali characters, existing multi-stroke recognition algorithm is not applicable for the development of Bengali handwriting education system, because it needs to provide the real-time students feedback. To address this problem, we have developed hierarchical online recognition algorithm to improve the recognition speed with considerably higher accuracy. It makes our system adaptable for web-based language learning and ensured immediate feedback about student's handwriting errors. In this hierarchical online recognition algorithm, we applied a series of matching filters to reduce a small number of candidates characters for final dynamic programming matching (DPM) where local features (angular feature) are used to guide DPM. Then character with low matching cost is selected as recognition results. Finally, it returns the recognition results. Using the structural information stored in a predefined structural dictionary, our algorithm can identify the handwriting errors automatically and feedback to students together with recognition results. Here, we have modified the traditional DPM algorithm that allows writing speed free variability and improve the recognition accuracy.

1.2 Related Background

In recent years, several research efforts have been done on e-learning system [3, 4] which aims to guide students to get more useful advice in their autonomous learning. They had developed an intelligence tutoring learning method to provide autonomous learning environment to the students. With the development of pen-based devices, it is now possible to apply e-learning techniques to handwriting education. Several handwriting education systems have been provided for different languages such as: Chinese, Latin and Arabic. It can be organized on three categories: read only systems, guided ones and systems with automatic errors detection. In case of Chinese handwriting education systems, the work proposed in [5] can find both the stroke production error and stroke sequence error but they did not consider the spatial relationship errors.

To develop a web-based handwriting education system for learning of handwritten Bengali characters, we need to develop an online recognition algorithm for cursive Bengali characters. Extensive research on cursive handwriting recognition has been done during the last few decades for different languages. However, there has not been much work on handwriting recognition of Indian scripts. Particularly, there have very few attempts for the recognition of online Bengali handwritten characters [6, 7]. But both of these two approaches are not applicable for the development of web-based handwriting education system, because of slow recognition speed. In our proposed education system, we have developed efficient hierarchical online recognition algorithm to speed up our system. Here, the student can practice their writing on the digital tablet accessed from both of iPhone/smartphone or computer browser. Then, our recognition engine can analysis the student's handwriting input and checks the handwriting errors to provide useful feedbacks.

2 Bengali Handwriting Education System

2.1 Handwritten Bengali Character Set

Bengali is official language/script of Bangladesh and used by 211 million people of India and Bangladesh. It is also second most popular language/script in India and fifth most popular language in

the world. Bengali, like other major Indian characters, is a mixture of syllabic and alphabetic scripts. It came from the ancient Indian script, Brahmi. The concept of upper/lower case is absent here and the direction of writing policy is left to right. Examples of Bengali characters are shown in Table 1. Bengali language consists of 50 basic characters including 11 vowels and 39 consonants. Most of the characters in Bengali language have a horizontal line at the upper part. We call this line as head-line or matra. Vowels have their modified shapes called vowel modifiers (VM). In Bengali script a vowel following a consonant takes a modified shape. Depending on the vowel, its modified shape is placed at the left, right (or both) or bottom of the consonant. These modified shapes are called modified or syllabic characters. In Bengali, there have 10 vowel modifiers which are joined with 35 of consonants and make 350 modified syllabic Bengali characters. On the other hand, several consonants or a vowel in conjunction with a consonant form a large number of possible different shapes, called compound characters. However, in the present day Bengali text, the occurrence of compound characters is less than 5% and the rest is only basic characters and vowel modifiers. So, our proposed autonomous learning system is focused on the learning and recognition of Bengali basic characters.

Table 1: Different shape of Bengali Characters

Type	Characters	Number	
Vowels	অ(a) আ(aa) ই(i) ঐ(ii) উ(u) ঊ(uu) ঋ(ri) এ(e) ঐ(ai) ও(o) ঔ(au)	11	50
Consonants	ক(ka) খ(kha) গ(ga) ঘ(gha) ঙ(nga) চ(ca) ছ(cha) জ(ja) ঝ(jha) ঞ(nya) ট(tta) ঠ(ttha) ড(da) ঢ(dha) ন(na) ত(ta) থ(tha) দ(da) ধ(dha) ন(na) প(pa) ফ(pha) ব(ba) ভ(bha) ম(ma) য(ya) র(ra) ল(la) শ(sha) ষ(ssa) স(sa) হ(ha) ঝ(rra) ঞ(rha) ঞ(yya) ঞ(khandata) ং(visarga) ঞ(anus -vara) ঞ(chad)	39	

2.2 System Architecture

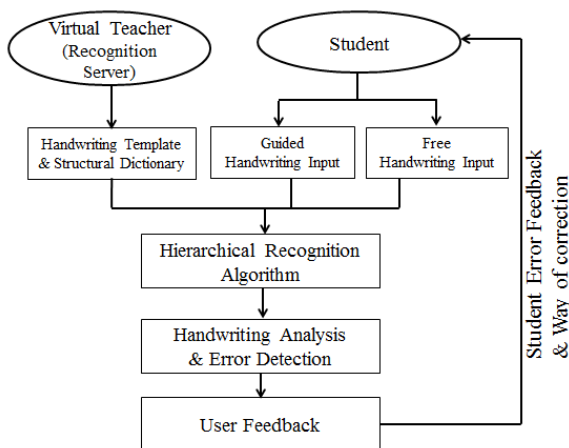

Figure 1: The architecture of the proposed Bengali Handwriting Education System

Figure 1 represents the operational flow of our proposed Bengali handwriting education system for autonomous learning. The proposed system is composed of two modules: the guided writing mode and the free writing one. The architecture of the system is detailed in figure 1. As shown in figure 1, students have the choice to practice the guided handwriting mode or the free one. In case

of free handwriting mode, writing will be done on a blank area, figure 2(b). The guided writing mode is one of the first levels of education designed for the children's who are in the early stages of learning. This tool displays a transparent image onto the digital web interface comprising this handwriting template, figure 2(a). Then, the user is invited to follow this image to replicate the pattern of script. After student submits their sample character, handwriting input was received in our recognition server (saying as virtual teacher) through WWW client-server interface. Then, by matching the handwriting template and the handwriting input, the recognition of the inputted character will be carried out. Finally, the automatic stroke error detection can immediately locate the student's handwriting errors and provide an immediate feedback to the student about the location of the error; their type and how to correct them (table 2 and table 3). The details of the automatic stroke error detection will be described in the following section.

We have developed a digital web interface that can access from both of iPhone/smartphone or computer browser. Figure 2 shows the snapshot of our web-based digital interface. It has three fields:

(1) Handwriting character input field, (2) Recognized character output field, and (3) Options buttons field. While the users write Bengali characters with an input device (e.g., pen, mouse, finger etc.) on the character input field. Then, our digital web interface gets the corresponding stroke data (sequence of points)

and sent to recognition server. Those data stored at the database, later we used it to evaluate our proposed education system. Once the interface gets the recognition result from the server, result is displayed at the character output field with system font including student's error feedback.

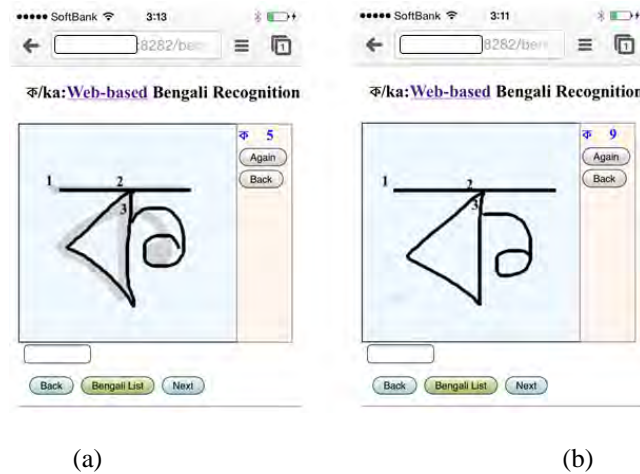

Figure 2: Digital web interface for Bengali handwriting education System that can be accessed from both of iPhone/smartphone or computer browser: (a) Guided handwriting mode (b) Free handwriting mode.

2.3 Automatic Stroke error detection & Stroke Feedback

2.3.1 Student Feedback for Autonomous Learning



In our Bengali handwriting education system, we have developed an automatic stroke error detection methodology. It aims to identify the handwriting errors in student's handwriting and provide immediate feedback. We classified the handwriting errors as stroke production error and stroke relationship error and stroke order error. Stroke production error consists of reverse stroke direction, split stroke and merge stroke errors etc. On the other hand, stroke relationship error is the error where students write the stroke with extra length and the stroke order error is the error of wrong stroke sequence.

Our automatic stroke error detection engine identifies the student's handwriting error and provides feedback to correct them. This error detection methodology was implemented using JSON: JavaScript Object Notation technology, see in figure 5. In this methodology, we marked erroneous strokes using different color models depend on the student's handwriting errors as shown in table 2 and 3. The notation of `{"r":["অ", "score"], "d":[1,-2,3], "c":["black", "red", "black"]}` is an example to clarify our proposed JSON technique. Here, we marked the reverse direction input stroke for character অ[a] by the red color. In this notation, "r" stands for the recognized character and its recognition score, "d" represents the stroke orders, and "c" is the color combination to mark the reversely inputted stroke. While the students write any stroke with reverse direction then our system

Table 2: Bengali handwriting error and idea of student's feedback

#	Error Category	Error Details	Color Marked Feedback
a	Correct handwriting	Correct Stroke	Black
b	Stroke production errors	Reverse direction	Red
		Split/broken stroke	Purple
c	Stroke relationship error	Stroke with extra length	Blue
d	Stroke order error	Wrong Stroke Sequence	Brown

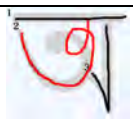
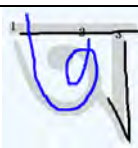
Table 3: Examples of handwriting error patterns of Bengali characters: (a) Stroke production error. (b) Stroke relationship error. (c) Stroke order error. (Numeric symbols means stroke no. and its start point)

#	Student's Error Feedback	Error Type	#	Student's Error Feedback	Error Type
1		Reverse stroke direction (Red)	3		Stroke with extra length (Blue)
2		Split stroke (Purple)	4		Wrong stroke order (Brown)

detect it and feedback with appropriate color marking. In this case, the second stroke was marked as red color. Thus, our proposed education system feedback student's error using different color models depend on their handwriting errors as shown in table 2 and 3.

2.3.2 Automatic stroke error detection: How does it work

In our web-based intelligent handwriting education system, we developed predefined structural dictionary based on the structural information of Bengali characters. Table 4 is the snapshot of structural dictionary for a single Bengali characters অ[a]. Based on this information, our recognition engine can successfully recognize the handwriting errors of Bengali characters and then feedback to students with necessary color marking.

Table 4: Snapshot of our predefined structural dictionary

#Unicode	Char.	Index	Positional Condition	Stroke order	Comments
0985 0000	অ	0	y2-b1! y2-j1! a3-x2!	1 2 3	#Correct
0985 0000	অ	1	y1-b3! y1-j3! a2-x1!	2 3 1	#Order errors
0985 0000	অ	2	y1-b2! y1-j2! a3-x1!	2 1 3	#Order errors
0985 0000	অ	3	y1-b2! y1-j2! a3-x1!	1 3 2	#Order errors
0985 0000	অ	4	y2-b1! y2-j1! a3-x2!	1 -2 3	#Reverse error

In table 4, (x, y) and (i, j) with corresponding stroke number represents the starting and ending point of input stroke respectively. (a, b) is the central point and calculated as $a=(x+i)/2$; $b=(y+j)/2$. For example, (x_1, y_1) , (i_1, j_1) and (a_1, b_1) represents the starting, ending and central point of first stroke. Similarly, the (x_2, y_2) , (i_2, j_2) , (a_1, b_2) and (x_3, y_3) , (i_3, j_3) , (a_3, b_3) represent the starting, ending and central point of second and third stroke. In this structural dictionary, single template character was presented with multiple structural patterns depend on its probable handwriting errors [8]. For example, the Bengali character অ[a] has 5 structural patterns considering its probable error case. Here, the third column, index is used to identify the handwriting error pattern of corresponding student's input. The fourth column, positional condition is used to locate stroke relationship error and provide correct recognition output together with necessary error feedback. Finally, the fifth column, stroke order is used to identify which stroke sequence was inputted and then provides colorful feedback to students about their wrong stroke sequence. Also, it identifies the reverse stroke direction errors by checking the negative value in stroke order column (5th column in Table 4). The all of this error detection mechanism will be discussed as below:

In our online handwriting recognition engine, we used client-server interface to extract the feature points and relevant structural information as (x, y) coordinates along the trajectory of the input device (e.g., pen, mouse, finger etc.) onto the digital web interface. Then, we convert it to angular

feature and match those angles with the angular features of preselected template characters and obtain a matching distance between them. In our system, each template character has its different structural patterns (index 0~4, as shown in table 4). Finally, it selects the optimal distance as the recognition results. Below is the mathematical notation:

$$k = \underset{k \in K}{\operatorname{argmin}} \{d_k\} \dots\dots\dots (1)$$

K = Total number of template characters

k = Student's sample character

d_k = Angular distance between sample characters and template characters considering multiple structural patterns of each template.

O_k = Stroke order patterns

As discussed above, the character with optimal d_k is selected as recognition result and thus the corresponding index number can easily be identified. After the identification of index number, the relevant stroke order, O_k can also be located from the column 5 in table 4. Then we return the feedback to students about their writing mistake by marking the wrong strokes with brown color.

If the identified stroke order O_k has any negative value then our recognition engine can detect that the student has inputted a stroke with reverse direction. Then it returns feedback to students by marking the reverse strokes with red color. After the identification of reverse stroke direction, our recognition algorithm reverses the angular feature of corresponding template characters and matches with sample characters. In our system, angular feature of original template characters is stored into an array $t[]$. After the detection of reverse stroke direction, our algorithm automatically converted angular feature of original template characters using a common angular conversion rule ($180^\circ - \text{angle}$) and stored into an array $r[]$. Then we match the student's input stroke with corresponding reversed stroke of template characters. Thus, our recognition engine can successfully accept the reverse stroke input and provide students the correct recognition result.

In table 4, the fourth column is used to identify the stroke relationship errors, such as Stroke with extra length. In case of Bengali characters ঞ[a], the second stroke position is bottom of the first stroke. In correct recognition case, it satisfies the condition of $y_2 > b_1$ ($y_2 - b_1!$ in 4th column) where y_2 is the start point of second stroke and b_1 is the central point of first stroke. From the student input stroke data, our automatic error detection engine can judge that whether $y_2 > b_1$ or not. If $y_2 > b_1$ then handwriting was correct otherwise there have a stroke relationship error and then feedback to the students by marking the inputted stroke with blue color. In this way, our proposed intelligent handwriting education system can successfully provide the error feedback together with recognition output.

2.4 Recognition Methodology

In our bengali handwriting education system, a web-based handwriting client-server interface technique has been used for character recognition and student's feedback. We have designed the proposed system with the following distinctive features: (1) it is a web-based system developed by Java web application technology and works on WWW client browser (PC or iPhone/Smart phone browser) (2) Easy character input environment is provided according to use of rich editing functions and the input device (e.g., pen, mouse, finger etc.) (3) HTML5 canvas technology was used to detect and draw user input (4) Apache tomcat web server and PostgreSQL database was used for system implementation (5) Consecutive handwriting and recognition is possible (6) immediate student feedback.

Figure 3 shows the handwriting recognition architecture that contains both of web-based handwriting interface and character recognition servers. Handwriting interface was developed by JSP and runs on WWW client, such as PC browser or iPhone/Smartphone browser. On the other hand, JSP based character recognition engine works on Apache tomcat web server (Linux server). While the students write Bengali characters with an input device (e.g., pen, mouse, finger etc.) on the character input field. Then, our digital web interface gets the corresponding stroke data as (x, y) coordinates and sent to the character recognition server. After that, the recognition engine converts the student's stroke data into angular feature in feature extraction stage, see in right side of figure 3. After applying smoothing to those extracted angular feature, our algorithm entered into hierarchical filtering stage. In

this stage, we have applied a series of filters in a hierarchical manner to reduce the search space of final DP matching. The first filter performs coarse classification on a large number of candidates based on the high level features of stroke patterns, such as stroke number. It reduces the candidate character models. Then the second filter performs structural preselection among the resulted samples of filter 1, based on the structural information of Bengali characters stored in our predefined structural dictionary (table 4). Again, it reduces to a small number of candidates for final DP matching. In the final matching stage, low-level features (angular feature) are used to guide a dynamic programming matching algorithm. In this stage, it calculates distance between input strokes and template strokes of each preselected characters by using our modified DPM. The character with optimal distance is selected as recognition result. After that, our recognition engine returns k top ranked characters as recognition results to client side browser. Then, it displayed the results into recognized character output field of our digital web interface.

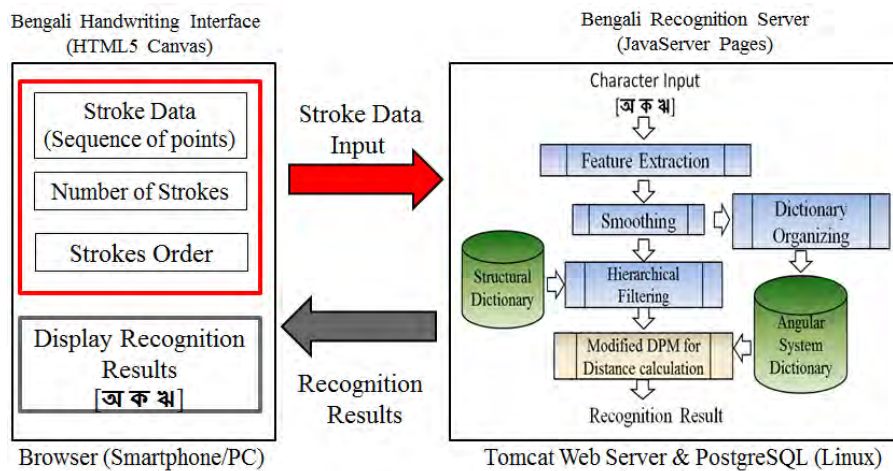

Figure 3: Handwriting recognition architecture for Bengali handwritten education system

2.4.1 Modified Dynamic Programming for writing speed-free recognition

In this section we explained about our proposed modified dynamic programming algorithm that support writing speed free recognition. In our proposed system, the recognition scheme is carried out using dynamic programming concept which is modified by accepting different length of input feature points to support writing speed free recognition. According to dynamic programming matching algorithm, handwritten input pattern is matched with template patterns by calculating optimal matching cost, also known as character distance [9, 10, and 11]. In our recognition scheme, the term character distance stands for the angular difference between input stroke's angles and corresponding template stroke's angles. Then the character with optimal distance is selected as our recognition output and return back to students with necessary feedback. The mathematical notation for DP matching is explained as follows.

To match handwritten input character with the template characters, we calculate character distance, D_k for corresponding template pattern k . A normalize distance D_k for the candidate character k can be calculated as follows,

$$D_k = \frac{1}{L} \sum_{l=1}^L d_{kl} \dots\dots\dots(2)$$

Where, L is the number of total input strokes, k is the candidate template characters, and l is the number of handwritten strokes. The candidate character with smallest D_k is selected as the recognition result for current handwritten input character. The stroke distance for each template character can be calculated using dynamic programming matching technique as follows,

$$d_{kl} = \frac{g(I_l, J_{kl})}{I_l + J_{kl}} \dots\dots\dots(3)$$

Where, $g(I_l, J_{kl})$ represents the DPM distance between input feature vector I_l and k_{th} template feature vector J_{kl} for corresponding stroke l . The following recurrence relation is used to find the DPM distance between two sequences,

initially,

$$g(i, j_{kl}) = \begin{cases} 0 & (i = 0, j_{kl} = 0) \\ \infty & (\text{other}) \end{cases}$$

recursively,

$$g(i, j_{kl}) = \min \left\{ \begin{array}{l} g(i, j_{kl} - 1) + d(i, j_{kl}) \\ g(i - 1, j_{kl}) + d(i, j_{kl}) \\ g(i - 1, j_{kl} - 1) + 2d(i, j_{kl}) \end{array} \right\} \dots\dots\dots(4)$$

Where, $g(I, J_{kl})$ is the cumulative distance up to the current template character, $d(i, j_{kl})$ is local cost for measuring the dissimilarity between i^{th} and j_{kl}^{th} point of two sequences.

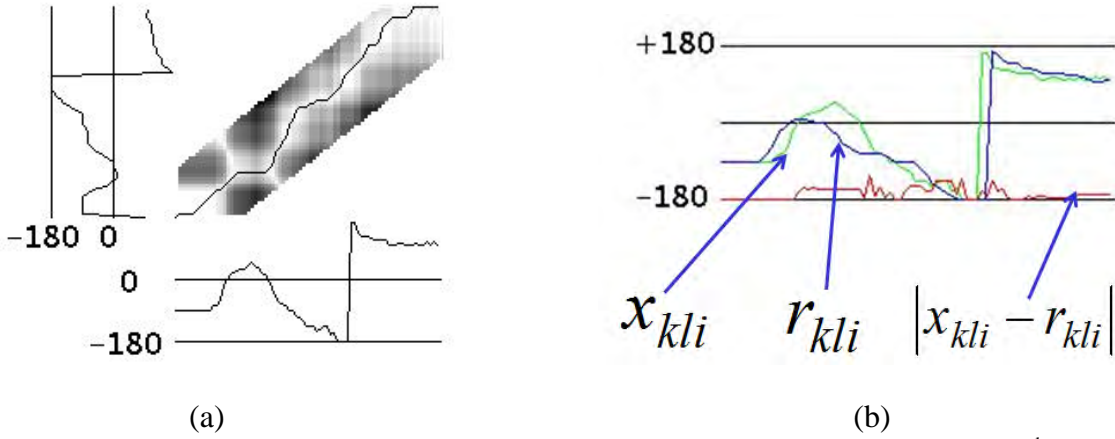

Figure 4: Dynamic programming matching: (a) illustration of wrapping path for the 2nd stroke of Bengali character দা (b) Calculation of local distance also known as dissimilarity between two strokes sequences of input and template.

Figure 4 represents illustration of wrapping path for DP matching and dissimilarity measurement between two strokes sequence. Here, x_{kli} represents the student's input stroke angles and r_{kli} represents the template stroke angles. The local distance as well as dissimilarity between the two stroke sequences can be measured as below:

$$d(I_l, J_{kl}) = \begin{cases} |x_{kli} - r_{kli}| & \{-180^\circ \leq |x_{kli} - r_{kli}| \leq 180^\circ\} \\ 180^\circ - |x_{kli} - r_{kli}| & \{|x_{kli} - r_{kli}| < -180^\circ\} \text{ or } \{180^\circ < |x_{kli} - r_{kli}|\} \end{cases} \dots\dots\dots (5)$$

To establish writing speed free recognition, we modified the traditional dynamic programming algorithm. As we explained in previous section, our handwriting digital web interface extracts the user stroke data (feature points) and sent to our recognition server. Fundamentally, the number of extracted feature points is inversely proportional to student's handwriting speed. Slow writing speed provides large number of feature points, and oppositely fast writing has small number of feature points.

$$\text{Number of input stroke data} \propto \frac{1}{\text{Students handwriting speed}} \dots\dots\dots (6)$$

As in equation 5, local cost as well as dissimilarity measurement between i^{th} and j_{kl}^{th} point of two sequences can be calculated by $d(I, J_{kl})$ where I is the number of input stroke and J_{kl} is the number of k^{th} template stroke. For slow handwriting case, I may greater than or equal to $2 * J_{kl}$. Oppositely in case of fast handwriting, J_{kl} may greater than or equal to $2 * I$. In this condition, the calculation of local stroke

distance, dissimilarity measurement $d(I, J_{kl})$ (in equation 5) may fail due to the adaptability problem of adjustment window size in DPM algorithm. To avoid this problem, we modified the existing DPM to accept the input strokes data of any length wherever it greater or smaller than two times of corresponding template stroke's length. By using the following settings of adaptive adjustment window size as equation 6, our modified DPM can accept any length of handwriting input. Here, W represents the adjustment window size. From the experimental analysis, we found the optimal value of $W=18$, that makes our system highly adaptable to recognize rough handwriting characters.

$$1 \leq i \leq I_l, \max\{1, i \times \frac{J_{kl}}{I_l} - W\} \leq j_{kl} \leq \min\{J_{kl}, i \times \frac{J_{kl}}{I_l} + W\} \dots\dots\dots (7)$$

In practical, our intelligent Bengali handwriting education system was developed to improve the Bengali literacy rate by considering both of children and older students. Basically, children have slow handwriting speed and aged people have fast handwriting speed. By the above modification, our recognition engine can accept both of input patterns from children and older people. In this way, we can successfully implement the writers' independent recognition algorithm for our web-based Bengali handwriting education system. By using this writing speed free recognition technique, the accuracy was improved considerably. In next section, we evaluate our proposed system using a rich Bengali handwritten character database.

3 Experimental Results

For our experiment, handwritten patterns were collected from 24 Bengali native writers of different groups with respect to age, education and gender, where each has written almost 10 times of every character sample. There are 50 basic characters in Bengali and therefore the proposed system has been evaluated by using 12,500 handwritten online character samples. We study the performance of proposed web-based intelligent handwriting education system by the three criteria: average recognition accuracy, average recognition speed, and automatic error detection capability.

Table 5: The Experiment Results
Scheme1: Modified Dynamic Programing Algorithm
Scheme2: Traditional Dynamic Programing Algorithm

Recognition Scheme	No. of Database	Top1 (%)	Top2 (%)	Top3 (%)	Speed (ms/char)
Scheme1	12500	87%	92%	95%	40ms
Scheme2	12500	78%	80%	83%	880ms

Average recognition accuracy can be calculated by dividing the number of correctly recognized test patterns with the total number of test patterns. Average recognition speed is calculated by dividing the total recognition time with number of recognized test patterns and its unit is characters per millisecond (ms). Average recognition accuracy is given up to top 3 choices. In this experiment, we used two different recognition schemes, Scheme1 and Scheme2, writing speed free modified DPM was used for final matching stage in Scheme1 whereas traditional DPM was applied in Scheme2. Table 5 gives the experimental results of our proposed system. We noticed that Scheme1 achieved the highest recognition accuracy for every top choice; particularly it achieved 95% accuracy considering Top3 choice. Moreover, the recognition time for Scheme1 is about 22 times lower than that of Scheme2. These facts ensured that proposed hierarchical recognition with modified DPM reduced the inherent computational complexity and speed up the recognition.

Figure 5 represents the snapshot of student's feedback result to correct their error handwriting. As we described in section 2.3, our proposed education system can successfully feedback to the students about their error handwriting using colorful marking technology. We implemented this method to our system by JSON: JavaScript Object Notation technology. In our preliminary experiment, we gathered stroke data from high level native Bengali speakers. In future we will do the experiment for various levels of Bengali learners with different age. Finally, we made a survey among 100 (almost) of native Bengali speakers for the acceptance of our education system. We considered the user's viewpoints about the system effectiveness. The user's comments confirmed that the proposed Bengali handwriting education system can be very helpful to improve the Bengali literacy rate in near future.

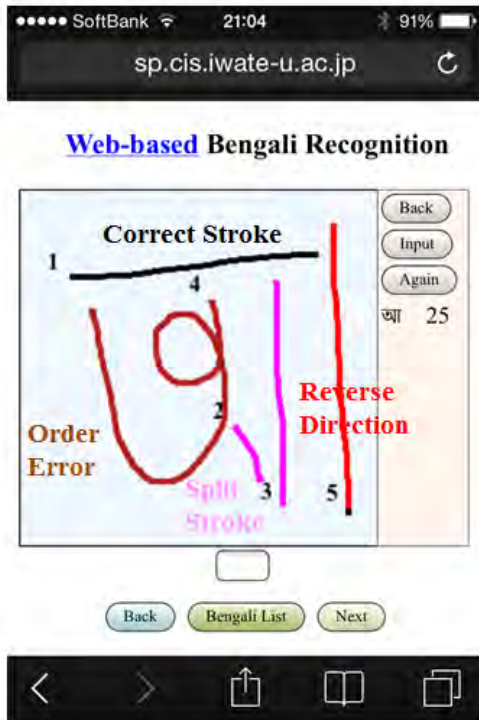

Figure 5: Automatic error detection and colorful feedback to correct student's error handwriting. (Numeric symbols means stroke no. and its starting point)

4 Conclusion and Future Work

In this paper, we have described about the implementation details of web-based intelligent handwriting education system for autonomous learning of Bengali handwritten characters. Here, we developed a web-based (iPhone/Smartphone or computer browser) handwriting client-server interface using JavaServer Page (JSP) technology to improve the Bengali literacy rate. We used 12500 of Bengali isolated character database for system evaluation. Our experimental results showed that the use of hierarchical recognition algorithm together with writing speed free modified DPM improved the recognition accuracy to 95% as well as recognition speed of 40ms. It makes our recognition algorithm adaptable for the application of web-based language learning application. Our automatic error detection methodology ensured the necessary feedback to the students to learn about their handwriting mistake autonomously. In future, we will focus our research on the development of Bengali handwriting education system considering Bengali word learning. Furthermore, partial function of our system can be accessed from the following URL:

"<http://www.sp.cis.iwate-u.ac.jp/icampus/b/>"

Acknowledgements

We would like to thank all the people who supported to accomplish this work.

References

- [1] Report on the Bangladesh Literacy Survey, 2010 "<http://www.bbs.gov.bd/webtestapplication/userfiles/image/Survey%20reports/Bangladesh%20Literacy%20Surver%202010f.pdf>"
- [2] Hu Z., Xu Y., Huang L., Leung H., (2009) "A Chinese Handwriting System with Automatic Error Detection", Int. J. of Software, Special Issue of Advanced Distance Learning Technologies, vol. 4, Issue 2, pp 101-107.
- [3] O. K. Zein and Y. Kernmarrec, November 2007, "Description and composition of e-learning", Journal of software, vol.2. no.5, pp.74-83.
- [4] K.Hiekata, October 2007 "A framework for design engineering education with workflow-based e-learning system", Journal of software, vol.2. no.4, pp.88-95.
- [5] K. T. Tang, K. K. Li and H. Leung., July 2006 " A web-based Chinese handwriting education system with automatic feedback and analysis" , Lecture Notes in Computer Science, vol. 4181, (Proceedings of the 5th International Conference on Web- based Learning (ICWL 2006)), pp.176-188.
- [6] U. Bhattacharya, A. Nigam, Y. S. Rawat, S. K. Parui, 19-21 August, 2008 "An Analytic Scheme for Online Handwritten Bangla Cursive Word Recognition", in the Proceedings of the International Conference on Frontiers in Handwriting Recognition (ICFHR 2008), pp. 320 - 325, Montreal, Canada.
- [7] S. K. Parui, K. Guin, U. Bhattacharya and B. B. Chaudhuri, 2008 "Online Handwritten Bangla Character Recognition Using HMM", Proceedings of 19th ICPR published by IEEE Computer Society Press.
- [8] Todd David Rudick: Japanese/English dictionary and character dictionary browser featuring handwriting recognition-based character lookup, ACM "Quest for Java Contest", JavaDict (1997). "<http://www.cs.arizona.edu/projects/japan/JavaDict/>"
- [9] J. Shin, 2004 "On-line cursive hangul recognition that uses DP matching to detect key segmentation points" Elsevier Pattern Recognition 37, 2101-2112.
- [10] L. Prasanth, V. Jagadeesh Babu, R. Raghunath Sharma and G.V. Pradhakara Rao, Sep. 2007 "Elastic Matching of Online Handwritten Tamil and Telugu Scripts Using Local Feature," Proc. of ICDAR'07, Vol. II, pp.1028-1032.
- [11] N. Joshi, G. Sita, A. G. Ramakrishnan, 2004 "Comparison of Elastic Matching Algorithms for Online Tamil Handwritten Character Recognition" IEEE Computer Society, Proceedings of the 9th Int'l Workshop on Frontiers in Handwriting Recognition (IWFHR-9).

The Effect of Visualizing Lesson Structures in a Teacher Education Program

Toshinobu KASAI^{a*}, Kazuo NAGANO^b & Riichiro MIZOGUCHI^c

^aOkayama University Graduate School of Education Master's Program, Japan

^bFaculty of Liberal Arts, University of the Sacred Heart, Japan

^cResearch Center for Service Science, Japan Advanced Institute of Science and Technology, Japan

*kasai@okayama-u.ac.jp

Abstract: We have built an instructional design support system called “FIMA-Light” which reasons about a teacher’s intentions from his/her lesson plan and automatically produces I_L event decomposition trees. The decomposition tree expresses the ways of achieving a learner’s state change that should be realized in a whole lesson in the form of a tree structure. In this paper, we discuss the difficulty of attaining the goals of university education without using our approach. We also report on practical use of FIMA-Light in teacher training at university in order to investigate changes in students’ awareness of teaching strategies brought about by providing them with I_L event decomposition trees.

Keywords: Instructional Design, Ontology, Teacher Training, Teachers’ Professional Ability

1. Introduction

Alignment between teaching practices in school and teacher education provided at university is an important aspect in improving teacher education programs (The Central Education Council, 2006). However, almost all universities provide only abstract descriptions in their policies, such as “Bridging Theory and Practice” (Department of Teaching & School Leadership, Okayama University, 2013; Fujimura & Sakanashi, 2010; Graduate School of Teacher Education, Waseda University, 2013) about the alignment between teaching practices and university education. One group (Mishima, Saito & Mori, 2009) analyzed the awareness of trainee teachers before and after their teaching practices in the classroom and found that they tend to notice the importance of their university education only after completing their teaching practices. This tendency suggests that alignment between teaching practices and university education is not necessarily successful. In this study, we examined the ability of teachers to instruct learners (the ability to properly design and practice instruction). We also clarified the respective roles of teaching practice and university education in teacher education programs, as well as the relationship between them (Kasai, Nagano & Mizoguchi, 2013). From this investigation, we identified the following two main goals that university students (trainee teachers) should aim to achieve in their university education before their teaching practices:

- To understand that there are various strategies (instructional/learning theories, teaching knowledge obtained from practices, etc.) for students to attain educational goals.
- To improve their skill at interpreting global and local strategies included in lessons designed by themselves or others
 - in order to learn skills from lessons designed by expert teachers, and
 - in order to improve their skills through discussion with peer students.

We considered that the I_L event decomposition tree (described in 3.1), which is defined based on the OMNIBUS ontology (Hayashi, Bourdeau, & Mizoguchi, 2009), might be suitable for such university education. We think that the goal of the university education should be to let university students learn the skills needed to produce not only lesson plans but also I_L event decomposition trees. Since university students cannot think in the structure of lessons, it is difficult

for them to produce I_L event decomposition trees. We have proposed the use of a system called “FIMA-Light” (Kasai, Nagano and Mizoguchi, 2011) which automatically produces I_L event decomposition trees. In that study, we showed that I_L event decomposition trees that FIMA-Light produces had effective information for university education in a teacher training course. In this paper, we report the results of practical use of FIMA-Light in university lectures in a teacher training course. The aim of this practical use was to investigate changes in students’ consciousness about strategies brought about by providing them with I_L event decomposition trees.

The remainder of this paper is structured as follows: In Section 2, we explain the difficulties in attaining the goals of university education without using our approach. In Section 3, we describe the features of our study that can overcome these difficulties. In Section 4, we report the results of the practical use of FIMA-Light in lectures in a teacher training course. This is followed by a discussion of some related work and concluding remarks in Section 5.

2. Difficulties in Attaining the Goals of University Education

In this section, we explain the difficulties in achieving the goals of university education in the current situation (without using our approach). In order to achieve the goals, it is necessary to achieve the following four sub-goals for goal achievement. Below, we explain the difficulty in achieving each sub-goal.

- Professors who have the skills that university students should acquire and who can instruct them should exist in the teacher training course.

Since professors in various domains instruct university students, it is important to share various strategies (instructional/learning theories, teaching knowledge obtained from practices, etc.) among the professors so that university students do not become confused. However, it is often difficult to share strategies (especially teaching knowledge obtained from practices) among them, since their fields of specialty are different.

- Professors should teach university students various strategies.

What university students should learn is that various strategies exist to attain an educational goal. Therefore, it is important to teach them every strategy in the same representation format so that they can compare them. However, it is difficult to attain this sub-goal, since representation formats differ among different learning/instructional theories.

- Professors should teach strategies that are applied in expert lessons from global to local viewpoints.

This sub-goal is to make university students understand the relations between various strategies and actual lessons. Here, in order to represent outlines of lessons, most universities (faculties) offering teacher education and school teachers utilize a format called a “lesson plan”. Though there is no standardized format for a lesson plan, in general, teachers use a lesson plan to describe the learning activity, instructional activity, evaluation method, and points to consider while teaching in every scene of their lessons. However, since a lesson plan describes mainly superficial concrete activities, it is difficult to describe strategies that include the teachers’ deep intentions. Therefore, in order to attain this sub-goal, professors have to extract global and local strategies that are included in each lesson by interpreting the lesson plan. Even if professors have sufficient skills, it is difficult for them to interpret teachers’ intentions that are not described.

- Professors should make university students aware of the relations between various strategies and lesson plans designed by the university students.

In university education, university students should improve their skills in designing lessons that integrate a global strategy for attaining an overall goal in the whole lesson and local strategies for attaining sub-goals. However, before they attain this goal, they themselves cannot interpret relations between strategies and lessons that they design from global to local viewpoints. Therefore, professors have to interpret the lesson plans that university students design. Since

lesson plans designed by university students often include illogical and unnatural flows, it is more difficult for professors to interpret the lesson plans.

The purpose of this study is to solve the difficult problems explained in this section and to provide a method that supports the achievement of the goals of university education.

3. Features of this Study

In this section, we explain the I_L event decomposition tree and FIMA-Light which we propose for practical use in university education in order to solve the problems described above.

3.1 The I_L event decomposition tree and its features

In the format of a “lesson plan”, teachers describe the learning activity, instructional activity, evaluation method, and points to consider while teaching in every scene of their lessons. This format is generally used also in teaching practices. Therefore, it is important for trainee teachers to learn how to describe their plans for their lessons in the format of a lesson plan before their teaching practices. However, since a lesson plan describes mainly superficial concrete activities, it is difficult for university students to consider strategies to be applied in the lesson from global to local viewpoints. Therefore, we think that effective instruction in university education cannot be realized using only the lesson plan as a format to represent lessons. Another representation format that will help university students to think from a more global viewpoint is required.

We considered that the I_L event decomposition tree, which is defined based on the OMNIBUS ontology (Hayashi, Bourdeau, & Mizoguchi, 2009), might be suitable for such university education. The OMNIBUS ontology has been constructed to organize a variety of learning/instructional theories and empirical knowledge extracted from best practices independently of learning paradigms. The core concepts of the OMNIBUS ontology are an I_L event and its decomposition structure. An I_L event is a basic unit of learning and instruction and is composed of a state change of a learner, an instructional action, and a learning action. A method for realizing the state change (macro I_L event) is expressed by a decomposition relation with multiple micro I_L events, called a WAY. In the OMNIBUS ontology, every piece of knowledge extracted from learning/instructional theories and practices can be described as a WAY. A macro I_L event is decomposed into several micro I_L events by applying a WAY. With this modeling framework, the flow of a lesson is modeled as a tree structure of I_L events that is called an I_L event decomposition tree. The root node of the decomposition tree is an I_L event that shows the intended learner’s state change that should be realized in the whole lesson. In the decomposition tree, higher layers express instructional strategies of more global viewpoints. And by decomposing these into lower layers, this decomposition tree can express instructional strategies of more local viewpoints.

We think that these features of the OMNIBUS ontology and the I_L event decomposition tree can solve the problems caused by the lack of a unified representation format for various strategies.

3.2 Overview of FIMA-Light

FIMA-Light automatically produces relevant I_L event decomposition trees from the trainee teachers’ lesson plans based on the OMNIBUS ontology. In order to input lesson plans to FIMA-Light, teachers select concepts prepared as instructional and learning activities for each step in the flow of their lesson plans. The current version of FIMA-Light produces I_L event decomposition trees based on 100 Ways that were extracted from learning/instructional theories

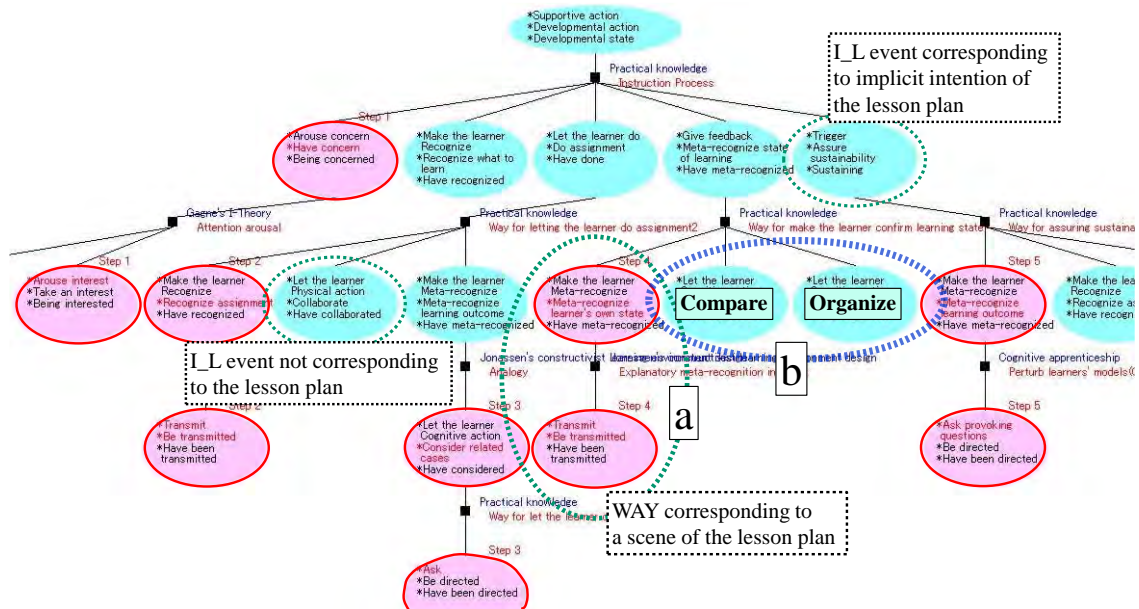

Figure 1. An example of an I_L event decomposition tree and its structure.

and 20 Ways that were extracted from practice lessons. An example I_L event decomposition tree that FIMA-Light produced by interpreting an actual lesson plan is shown in Figure 1. An I_L event decomposition tree includes two kinds of nodes. One includes pink nodes that show I_L events which FIMA-Light judged corresponding to the lesson plan. The other includes blue nodes that show I_L events that FIMA-Light judged not corresponding to any steps explicitly described in the lesson plan. The aim of FIMA-Light is to help teachers to deeply reflect on their lesson plans by providing them with the I_L event decomposition trees. By doing so, it is expected that they themselves will notice how to improve their lessons. We evaluated FIMA-Light in actual use. The results of the evaluation showed that FIMA-Light produced I_L event decomposition trees that were sufficiently relevant to the designed lessons (teachers answered that, on average, 89.2% of the nodes were relevant to the designed lessons). Thanks to the I_L event decomposition trees provided by FIMA-Light, teachers found 2.5 improvement points in each lesson plan, on average.

In university lectures of a teacher training course, FIMA-Light produced 30 I_L event decomposition trees by interpreting lesson plans that university students designed (refer to Section 4). We think that the interpretation of these 30 lesson plans could not have been realized without this system.

4. Use of FIMA-Light in University Lectures

4.1 Purpose of the Use of FIMA-Light

The lectures in which we used FIMA-Light were “Studies on Information Study Method A” and “Studies on Educational Contents of Technology Education (Information)”, given at the Faculty of Education that one of the authors of this paper belongs to. Ten students attended these lectures in 2013. All students had learned how to write lesson plans in other lectures and had experience of teaching practice. The purpose of this investigation was to find answers to the following three questions:

- Can university students on teacher training courses be aware of the relations between the flow of instructions and the educational goals of instructions (whole goals and sub-goals of instructions) from descriptions of lesson plans?
- Can FIMA-Light produce I_L event decomposition trees that are sufficiently relevant to lessons designed by university students?

- Can I_L event decomposition trees improve university students' awareness of strategies from global to local viewpoints, whose aim is to let school students attain the educational goals?

In order for university students to efficiently attain the above goals in their university education, it is necessary to create suitable feedback based on I_L event decomposition trees according to the situation. As a preliminary stage to a discussion of suitable types of feedback, we focused on the changes in university students' awareness brought about by providing them with I_L event decomposition trees. The investigation was conducted via the following steps.

1. The instructor (the first author of this paper) directed the university students to create lesson plans and describe what teachers should consider in each scene of the lessons to attain the overall goal of the whole lesson or sub-goals, if they noticed something.
2. The instructor directed the university students to evaluate learning/instructional flows of lesson plans that other students created and to give their comments.
3. The instructor provided every university student with other students' comments and directed them to improve their lesson plans.
4. The instructor explained the I_L event decomposition tree.
5. The instructor inputted data of all lesson plans into FIMA-Light and provided every university student with two I_L event decomposition trees which FIMA-Light produced based on his/her lesson plans (two versions of the lesson plan before and after improvement).
6. The instructor asked every university student whether or not every node of his/her I_L decomposition tree was relevant to his/her designed lesson, independently of whether this was done explicitly or implicitly.
7. The instructor directed them to improve their lesson plans.
8. The instructor inputted data of improved lesson plans into FIMA-Light and provided the university students with the I_L event decomposition trees. The instructor asked them whether or not every node of the I_L event decomposition trees was relevant to his/her designed lesson.
9. The university students gave a score between one and five (with one being the lowest and five being the highest) in response to the question, "Did you think that your awareness of strategies from global to local viewpoints, whose aim was to let students attain the educational goals, was enhanced by the I_L event decomposition tree?"

The investigation was conducted by using the following five steps:

- A) We analyzed a rate the number of comments that evaluated the flow of the lesson based on the relation with the overall goal of the whole lesson or the sub-goals.
- B) We analyzed the 30 I_L event decomposition trees (FIMA-Light produced three I_L event decomposition trees for every university student).
- C) We analyzed how the number of descriptions of what university teachers should consider in attaining the overall goal of the whole lesson or the sub-goals changed by improving the lesson plans.
- D) We analyzed the results of the questionnaire conducted at the end.
- E) We analyzed how the university students improved their lesson plans when provided with the I_L event decomposition trees.

4.2 Results of the Investigation and Discussion

Table 1 shows the results of step A). The flow of a lesson plan cannot be evaluated without considering the relations with its purpose, which is to attain the goal of the whole lesson or the sub-goals. Therefore, the relations with goals should be included in all comments. However, the relations with goals were included in only 21 out of 50 (42%) comments. In particular, the relations with sub-goals were included in only 2 out of 50 (4%) comments. This result shows that university

Table 1. The result of the analysis of a rate of comments related to goals

Total number of comments	The number of comments related to overall goals	The number of comments relate to sub-goals
50	19 (38%)	2 (4%)

students on teacher training courses are hardly aware of the strategies that are applied in order to attain the goals (especially sub-goals) of instructions from the descriptions of lesson plans.

Table 2 shows the results of step B). Some lesson plans designed by the university students included illogical and unnatural flows. However, FIMA-Light could produce I_L event decomposition trees that included all scenes in the flow of 30 lesson plans (every university student designed three versions of the lesson plan). The university students answered that on average about 90% of nodes were relevant to designed lessons. These results show that the current version of FIMA-Light can produce I_L event decomposition trees that are sufficiently relevant to the lesson plans that university students design.

Table 3 shows the results of step C). Every scene described in a lesson plan should have the role of attaining the overall goal of the whole lesson and the sub-goals. Therefore, one or more descriptions that include the relations with the goals of the instructions for every scene should exist. However, before providing the university students with I_L decomposition trees, there was on average only one description in each lesson plan, though the instructor directed them and provided them with examples. This result shows that the university students were hardly aware of strategies (especially local strategies) whose aim was to let school students attain the educational goals. After they referred to the I_L event decomposition trees, there were on average 5.1 such descriptions (including 1.6 descriptions related to sub-goals) in each lesson plan. The number of descriptions in the improved lesson plans is not enough either. We think that the increase in the number of descriptions related to goals in the instructions does not show that the skills which university students should learn in the university education improved, because global and local strategies in their lessons were provided explicitly by I_L event decomposition trees. However, from the results of the questionnaire (university students gave an average score of 4.6 in step D)), we judged that providing students with I_L event decomposition trees produced the following effects:

- improved the university students' awareness that there are various sub-goals according to strategies for attaining the overall goal of the whole lesson.
- improved the university students' awareness that there are various strategies for students to attain educational goals.
- improved the university students' awareness of strategies from global to local viewpoints, whose aim is to let school students attain the educational goals.

Table 2. The result of the analysis of 30 I_L event decomposition trees

Average of 10 I_L decomposition trees for each version	The number of scenes of a lesson plan	The number of scenes included in a tree	Total number of nodes in a tree	The number of nodes related to the lesson plan (judged by university students)
I_L event decomposition trees of the first versions of lesson plans	6.3	6.3 (100%)	28.9	24.6 (85.1%)
I_L event decomposition trees of the second versions of lesson plans	7.1	7.1 (100%)	32.4	28.1 (86.7%)
I_L event decomposition trees of the final versions of lesson plans	8.9	8.9 (100%)	37.6	34.0 (90.4%)

Table 3. The result of the analysis of descriptions in the lesson plans.

Average of 10 Lesson plans	The number of scenes of a lesson plan	The number of descriptions related to goals of the whole lesson	The number of descriptions related to sub-goals in a lesson plan
The first versions of lesson plans	6.3	1.2	0.1
The second versions of lesson plans	7.1	1.3	0.1
The final versions of lesson plans	8.9	3.5	1.6

Finally, we discuss concrete ways in which the university students improved their lesson plans when provided with the I_L event decomposition trees (step E)). Most of the improvements were achieved by adding scenes in which “I_L events not corresponding to the lesson plan”, as judged by FIMA-Light, were embodied. Figure 1 shows an I_L event decomposition tree that FIMA-Light actually produced from a lesson plan on information technology for high schools, designed by one of the university students participating in the investigation. The educational goal of the lesson was that students should understand “the characteristics of digitization of still pictures”. In the original lesson plan before it was improved, there was a flow containing a scene, “the teacher has students answer some questions” (“a” in Figure 1). The description for this scene was “have students confirm their understanding of knowledge that they learned in the instruction”. This description shows the relation between this scene and the goal of the whole instruction. However, we could not interpret the university students’ awareness that they regard “students confirm their understanding of knowledge” as a sub-goal. In the I_L event decomposition tree that FIMA-Light produced from the lesson plan, there were I_L events (“b” in Figure 1) aimed at letting students “compare” and “organize” after the above scenes. The university students added a scene “students discuss in groups” based on these nodes. Furthermore, they added a description “have students discuss in order to deepen their understanding of knowledge” for the added scene. In the I_L event decomposition tree before the lesson plan was improved, there was no node which can be interpreted as “students deepen their understanding of knowledge”. Therefore, we thought that the university students themselves could become aware of the existence of such a sub-goal and the strategy for attaining it.

Although our investigation was preliminary, the results suggest the possibility that using I_L event decomposition trees in university education can contribute to enhancing the quality of teacher education programs.

5. Related Work and Concluding Remarks

We have built an instructional design support system called FIMA-Light based on the OMNIBUS ontology. FIMA-Light can automatically produce I_L event decomposition trees from teachers’ lesson plans. We have previously evaluated FIMA-Light in practical use by incumbent teachers. In the present study, first, we considered effective alignment between university education and teaching practice in teacher education programs, and we reported the results of an investigation into the possibility that FIMA-Light can be utilized effectively for university education.

Here, we would like to discuss some related work on a system known as SMARTIES (Hayashi, Bourdeau, & Mizoguchi, 2009) to contrast it with FIMA-Light. SMARTIES is an authoring system that aims to support teachers in designing learning/instructional scenarios based on the OMNIBUS ontology and that is compliant with the standard technology of IMS Learning Design. By using SMARTIES, teachers can make I_L event decomposition trees that are compliant with learning/instructional theories through deeply reflecting on the design intentions of their lessons. In addition, SMARTIES can suggest WAYs, described in the OMNIBUS ontology as strategies for achieving state changes in learners. In this approach, in which teachers employ a so-called top-down method, when they design scenarios, they have to think about deep intentions that they may not usually be explicitly aware of. For such instructional design, it is necessary for teachers to think deeply about the lessons from global to local viewpoints. Therefore, though this approach is effective for expert teachers, it is very difficult for novice teachers and university students (trainee teachers) to employ.

On the other hand, our approach employs a bottom-up method and can automatically produce I_L event decomposition trees through reasoning about teachers’ design intentions from given lesson plans that they usually design. With our approach, therefore, even novice (trainee) teachers can participate in this process. This is one of the features of our approach. To support

incumbent teachers, FIMA-Light does not directly improve, or tell them how to improve, their lesson plans by itself, because such support would prevent teachers from improving their professional skills. Therefore, by providing teachers with the I_L event decomposition trees that is produces, FIMA-Light aims at letting them themselves think about how to improve their lessons and in what respects. However, to support university students (trainee teachers), even though FIMA-Light provides them with I_L event decomposition trees, we cannot expect that they will recognize their underlying intentions. In order to support university students' learning, it is necessary to create suitable feedback based on I_L event decomposition trees according to their learning situation. To the best of our knowledge, there is no system that can automatically reason teachers' deep-level intentions from their designed lesson plans, and can support them based on the results of such interpretation.

The purpose of the university education that we proposed in this study is to provide university students with the ability to make I_L event decomposition trees themselves through thinking deeply about their lessons. Therefore, we think that, in the final stages of their university education, SMARTIES rather than FIMA-Light can support them more effectively. In future work, we intend to clarify how FIMA-Light should be utilized in university education in order to let university students efficiently attain the educational goals for teacher education. In particular, we intend to examine the following two topics: 1) the generation of suitable feedback based on I_L event decomposition trees produced by FIMA-Light, and 2) effective alignment between FIMA-Light and SMARTIES for university education in teacher education programs.

Acknowledgements

This work is supported in part by Grant-in-Aid for Young Scientists (B) No. 22700148 from the Ministry of Education, Culture, Sports, Science and Technology, Japan.

References

- Central Education Council (2006). How the teacher education should be conducted in the future. Home Page of Ministry of Education, Culture, Sports, Science and Technology, Japan, http://www.mext.go.jp/b_menu/shingi/chukyo/chukyo0/toushin/06071910.htm.
- Department of Teaching & School Leadership, Okayama University (2013). The purpose of Department of Teaching & School Leadership, Home Page of Department of Teaching & School Leadership, Okayama University, http://ed-www.ed.okayama-u.ac.jp/~kyoujissen/gaiyo_mokuteki.html
- Fujimura N., & Sakanashi M. (2010). Teaching profession special training for the improvement of practical teaching skills required of the teachers, *Journal of educational research / Center for Educational Research and Training*, Kyoto University of Education, Vol.10, 221-230.
- Graduate School of Teacher Education, Waseda University (2013). Three Policies of Graduate School of Teacher Education. Home Page of Graduate School of Teacher Education, Waseda University, <http://www.waseda.jp/ted/eng/about/outline/policy.html>
- Smith, S. J. (2004). *The Bearing of Inquiry in Teacher Education. The S.F.U. Experience*, Vancouver: Faculty of Education, Simon Fraser University.
- Curriculum Center for Teachers (2012). Project Report on Comparative Study on the Role of Schoolteachers in the Initial Teacher Education, http://www.u-gakugei.ac.jp/~curriect/data/reports/s2_international/schoolteacher.pdf
- Mishima T., Saito M., & Mori T. (2009). Change in the Images for Lectures in Teacher Training Program Expressed by Practice Teachers Before and After Practice Teaching. *Japan Society for Educational Technology*, 33(1), 93-101.
- Kasai T., Nagano K., & Mizoguchi R. (2011). Instructional Design Support System Based on Both Theory and Practice and Its Evaluation, *Proceedings of ICCE2011*, 1-8.
- Kasai T., Nagano K., & Mizoguchi R. (2013). Effective Alignment between University Education and Teaching Practice through Automatic Interpretation of Lesson Plans, *Proceedings of ICCE2013*, 158-160.
- Hayashi Y., Bourdeau J., & Mizoguchi, R. (2009). Using Ontological Engineering to Organize Learning/Instructional Theories and Build a Theory-Aware Authoring System, *International Journal of Artificial Intelligence in Education*, Vol.19, No.2, 211-252.

An intelligent tool to assist architecture students in the early stages of design

Eva MILLÁN^a, María-Victoria BELMONTE^{*a}, Manuela RUIZ-MONTIEL^a, Juan GAVILANES^b & José-Luis PÉREZ-DE-LA-CRUZ^a

^a*ETSI Informática, University of Málaga, Campus de Teatinos, 29080 Málaga (Spain)*

^b*Escuela de Arquitectura, University of Málaga, Málaga (Spain)*

*mavi@lcc.uma.es

Abstract: In this paper we present BH-ShaDe, an educational software tool that assists architecture students in the process of learning to design single-family dwellings. To this end, BH-ShaDe generates and proposes housing units schemes, which can serve as starting points in student's exercises and projects. The tool has been designed and implemented based on the ideas of reinforcement learning and shape grammars. The students can select the more promising schemes (among those generated by the tool), and then transform them in complete architectural plans, and finally use them to develop a complete residential project. To evaluate the validity of this approach, BH-ShaDe has been tested with 78 architecture students of the University of Málaga. The results have shown that the starting points were suitable, diverse and useful, and that they have helped students to learn how to design residential projects.

Keywords: architectural education, software tool, learning to design, meta-cognitive abilities

1. Introduction

In any design task it is not easy to start a new project, so architecture students usually struggle when they need to start a new design and face nothing but a blank sheet of paper. To this end, designers often use inspiration sources. The expression "*inspiration source*" describes the conscious use of different resources or even previous designs, as references for the solution to a problem (Eckert et al., 2000). These inspirations sources or starting points can act as triggers for the generation of new ideas, and even accelerate or facilitate the design process, especially in the case of novice designers. For that reason, computer-aided design tools or design assistants can be very useful in these early stages, allowing the exploration of different alternatives and providing feasible starting points.

To this end, we have developed BH-ShaDe (Basic House Shape Design), a software tool that is able to generate raw, schematic proposals (*schemes*) for housing units according to a given guideline (Montaner and Muxi, 2008). To generate these schemes automatically, BH-Shade uses shape grammars (Stiny, 1980), and to do it in an intelligent way, it uses reinforcement learning techniques (Sutton and Barto, 1998). In this way, architecture students can benefit from the existence of many feasible and varied starting points (basic house schemes) for their residential projects, which have been obtained effortlessly. In order to analyze the usefulness of such starting points in the process of learning to design, we have performed an experiment with a group of 78 architecture students of the University of Málaga, with promising results.

In the next section, we will briefly review some related work. The section 3 describes the software tool and its implementation, while Section 4 is devoted to the description of the experiment performed with architecture students. The results of the study are shown and discussed in Section 5. The paper finishes with some concluding remarks in Section 6.

2. Related Work

The computers have been used in Schools of Architecture and introduced in experimental laboratories for design with varied purposes: as a support to imagination and creativity (Elsen and Leclercq, 2008) (Peng and Jones, 2004) (Iordanova, Tidafi and Paoli, 2007); to assist in teaching and learning tasks

(McGill, 2001) (Jain, Kensek and Noble, 1998) or even to introduce virtual reality in architectural education (Redondo et al., 2011).

In relation to design learning, a number of tools have been implemented and tested. For example, SketSha (Elsen and Leclercq, 2008), which is a tool that helps students in the initial stages of collaborative design by supporting free-hand sketches, drawn in real-time in distant locations on a shared workspace. Another example is SUCoD (Peng and Jones, 2004), a web-based virtual city information system that supports 3D urban design. SUCoD allows students to link their CAD skills with knowledge of urban history to carry out urban design proposals. VRSolar (Jain, Kensek and Noble, 1998) and Shaper 2D (McGill, 2001) are examples of more specialized software tools that complement architecture teaching. VRSolar is a web-based teaching tool that helps in teaching topics related to the movement of the sun and its effects on the built environment, while Shaper2D is a design tool that assists students for learning about shape grammars and their uses in the design process. Other works also report innovative uses of computers in learning how to design. (Iordanova, Tidafi and Paoli, 2007) present a study (using case-based-reasoning) performed with architecture students that use a library of referents during their work on the design of a summer theater. Finally, (Redondo et al., 2011) use virtual reality in architecture teaching practices. They merge pictures and virtual models that allow students create interactive photomontages and facilitate the evaluation of the visual impact of their projects.

Our goal is to assist architecture students in the process of learning to design single-family dwellings. Design problem solving is considered a particularly complex task, since these kinds of problems are ill-structured (Simon, 1973), that is, they are characterized by the absence of a unique, well-defined solution. These types of tasks are difficult to teach. Certainly, an educational software tool that generates and proposes different starting points can be quite worthy for design stakeholders in the first stages of the design process. In this way, even though the system does not provide the students with the traditional resources of the tutorial systems (problem evaluation, reading texts,...), they obtain *feedback* on the rules and guidelines in the form of the generated schemes.

This approach is not new: architects frequently use this resource. For example (LeCuyer, 1996) cite Eisenmann's use of computer-generated forms as starting-points. The sources of inspiration or starting points more commonly used by architects or designers include: i) visual stimuli, like for example sketches (Goldschmidt and Smolkov, 2006), objects of nature (Demirkan and Afacan, 2012), or pictures (Casakin et al., 2000); ii) text as graphs words –for example, the tool Idea Space System (Seger, de Vries and Achten, 2005) which gives designers a word graph that contains architect's annotations and semantic associations based on them-; or iii) a mixture thereof, like (Malaga, 2000) that compares the generation of ideas in response to visual or textual stimuli and a combination of both.

However, none the above approaches generate the inspiration sources/starting points automatically. Moreover, to our knowledge, there is no computer-aided tool that provides students with automatically generated starting points. Therefore this is a distinctive feature of BH-ShaDe, which not only generates the schemes automatically, but also uses intelligent techniques and shape grammars to provide an unlimited number of schemes adapted to a given housing guideline.

3. The Tool

In this section we describe BH-ShaDe, a software tool that assist architecture students in the process of learning to design single-family dwellings. To this end, BH-Shade generates and proposes housing units schemes that can serve as starting points in students' exercises and projects. The tool has been designed and implemented based on the ideas of reinforcement learning and shape grammars. By means of reinforcement learning, an agent learns autonomously how to interact with the environment in such a way that the total reward is maximized. Learning occurs through interaction with the environment, by receiving positive or negative rewards after the execution of an action. The agents learn which sequences of actions (policies) yield a good total reward. In our case, reinforcement learning techniques (namely, Q-learning) are applied to “an agent” (a generator of architectural schemes) to obtain an improved version of the agent, which is able to provide good starting points for the student. BH-ShaDe is based on the formalism of shape grammars, so every action of the agent is the application of a rule of the grammar.

Shape grammars have been widely used in design and specifically in architectural research (Cagdas, 1996). A shape grammar is a formal language that represents visual thinking. To this end there is an initial shape (usually called axiom), and a set of design rules or transformations that can be applied

to different shapes. Figure 1 represents an example of an axiom, rule, and five successive applications of the rule, starting from the original axiom.

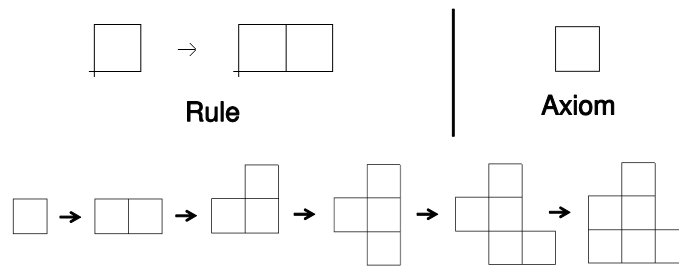

Figure 1. Simple shape grammar that adds squares, with one possible derivation

From the standpoint of generative CAD tools (Chase, 2002), shape grammar-based systems are particularly well suited to easily automate the design, allowing a great deal of exploration.

In what follows we will describe the main characteristics of BH-ShaDe. First we will present the architectural guideline in which it is based. Then we will briefly show BH-ShaDe main features, interface and architecture.

3.1 Criteria for the design of basic houses

Our goal is that students learn to design functionally feasible single-family dwellings. To this end, we have used an existing guideline, originally proposed by Montaner and Muxí architecture studio. This guideline is useful for architecture students to learn how to design dwellings. It also guides the generation of schemes for “*basic houses*” in our software tool. In our context, a basic house is defined as a house that, besides satisfying some minimum habitability conditions, also offers some *adaptability*, i.e., its spatial composition may be modified if the number of inhabitants varies. To generate such basic houses in an *intelligent* way, the tool makes use of reinforcement learning techniques. Therefore, BH-ShaDe is able to intelligently generate two-dimensional floor distribution schemes of basic, two-person housing units. All the schemes produced are distributed over one floor and its total area is restricted to 46 m² (as recommended in the guideline).

In Montaner & Muxí’s proposal, several kinds of spaces are considered: (1) *specialized spaces* (which need specific installations), (2) *non-specialized spaces* (do not need specific installations, and their use is determined by its inhabitants: dining-room, living-room, bedroom) and (3) *complementary spaces* (such as *distribution hall*, that allows circulation between spaces).

This set of criteria has been implemented as a set of *requirements*. By requirements we mean either constraints (for example, the area of each non-specialized space must be bigger than 9m²) or goals (the contour must be as compact as possible). The core of the software tool is a very simple set of rules, together with and an interpreter for them. Random sequences of rule applications would lead to schemes that would not satisfy the set of requirements. To avoid this, violations are automatically detected and *punished*. In this way, and by applying reinforcement learning algorithms, random sequences of rules are gradually replaced by “intelligent” ones (that avoid punishment). The process continues until we obtain a version of the rule interpreter (BH-ShaDe) that generates only *good* schemes. All these *good* schemes are created equal and they are not categorized by the tool. Note that the reinforcement learning process is performed off-line, just once, and prior to the use of the system by students. A detailed description of the interpreter and the learning procedure can be found in (Ruiz-Montiel et al. 2013).

3.2 BH-ShaDe Features

BH-ShaDe can work in two different modes: interactive and automatic. In the interactive mode, it allows an interactive execution of three fixed shape grammars, intended to help students learn the concept of shape grammars. The first one is the toy example shown in Figure 1. The second one generates a very simple housing unit. The third grammar (Figure 2b) is applied to the shape in the canvas when the rules are loaded. The rules then add non-specialized spaces to the housing unit. This

grammar makes sense when the shape in the canvas is a housing unit generated with the automatic generation module described below.

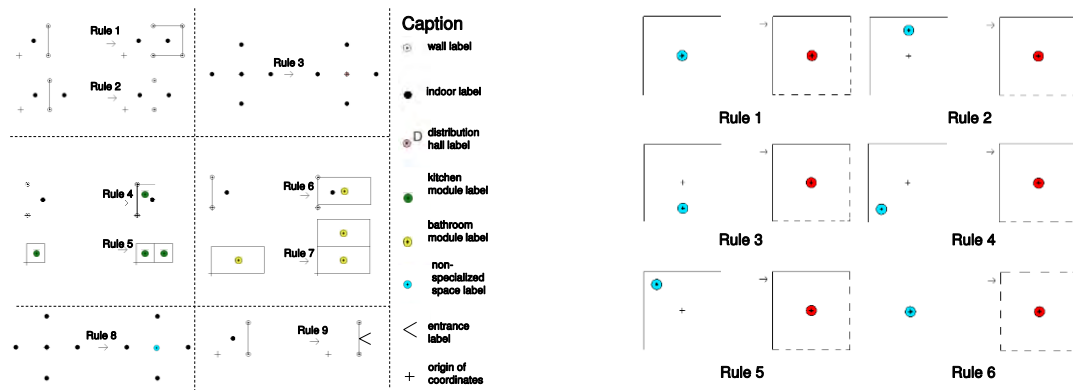

Figure 2. Shape grammars for the generation of a) basic house and b) non-specialized spaces

The automatic mode allows students to obtain housing units schemes according to Montaner and Muxi's guideline. These schemes are automatically generated by the computer, using the shape grammar shown in Figure 2a (that is hidden to students). In the automatic generation module, students just need to specify the desired number of schemes and then the tool will generate them.

3.3 BH-ShaDe Architecture and Interface

In this subsection we describe the architecture of BH-ShaDe and its interface. In Figure 3 we can see the different modules that interact in order to provide students with the aforementioned features.

BH-ShaDe is built on top of SketchUp (SketchUp, 2013), hence in the bottom of Figure 3 we can see some SketchUp-related modules. Our tool communicates with SketchUp by means of an Application Programming Interface (API). Immediately on top of this API module, we can see a *Shape Grammars Module* that encapsulates the shapes, the rules and the arithmetic for manipulating shapes. On the top, we can find BH-ShaDe interface, that mainly interacts with the two principal modules of BH-ShaDe: *the Interactive Generation Module* and *the Automatic Generation Module*.

The Interactive Generation Module deals with the interactive application of shape grammars by means of a general subshape detection algorithm. This algorithm is very powerful as it can detect possible application of rules of any general shape grammar. With the result of this algorithm the Search Algorithm finds a concrete rule application that satisfies the constraints (if present).

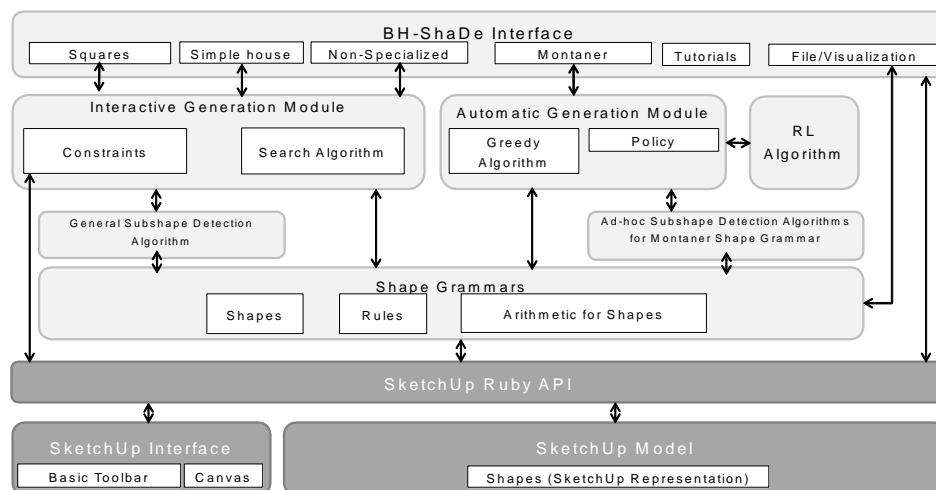

Figure 3. Architecture of BH-ShaDe

The Automatic Generation Module applies the shape grammar in Figure 2a by means of an ad-hoc subshape detection algorithm that only works with this shape grammar, but is much faster than

the general algorithm. With the result of this algorithm, the Greedy Algorithm chooses the best rule application with the help of the policy generated by the Reinforcement Learning (RL) algorithm. As we explained before, the policies inform about which rule applications lead to solutions that provide the best adjustment to Montaner and Muxi’s guideline. BH-ShaDe interface is built on top of SketchUp interface, as depicted in Figure 4. Shape grammars and the results of successive applications of rules (according to the user's choices or to the automatic generation module) are also shown in the interface.

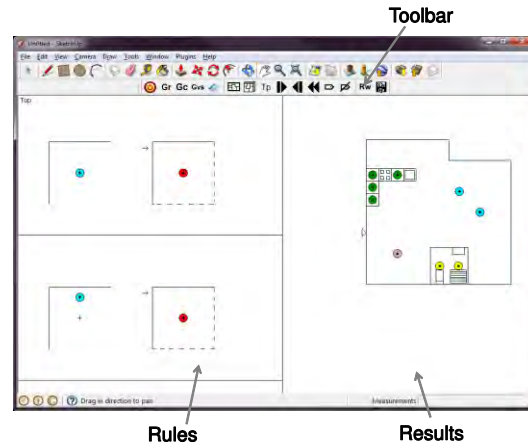

Figure 4. Screenshot of BH-ShaDe interface.

4. The Experiment

In this section we describe the experiment and its settings. The evaluation was performed with three groups of students enrolled in the subject *Architectural Projects VII*, which is taught in the seventh semester of the Architecture Degree of the University of Málaga. In total, 78 students participated in the experiment. Next we will describe the task they had to perform.

First, each student executed the grammar in Figure 2a to automatically generate a basic house. Then, they interactively separated the non-specialized spaces (i.e., placed the walls) using the shape grammar in Figure 2b. The students were then divided in groups of three members. Each group had then 3 schemes, that had been developed by each of their members, partially in automatic mode (the basic house), and partially interactively (walls). This procedure could have continued so students had a large enough collection of basic houses to use in their projects. However, the generation of each scheme consumed some time that was not useful in our overall goal of generating starting points that supported students. Therefore, we decided to use the automatic generation module of BH-ShaDe to automatically generate a further 24 schemes for each group, resulting in a total of 27 schemes per group.

To promote discussion and reflection among the students, these 3-member groups were joined in larger groups of nine students. Each one of these larger groups had then 81 unique schemes that they had to classify according to the following criteria: A (optimal), B (adequate), C (some modifications needed), D (problematic) and E (absurd). Once the schemes had been classified, they had to select the most suitable for different kinds of groupings: row-houses, apartment blocks, galleries, single-family houses. Based on these selections they had to develop a complete architectural project, proposing single-family housing solutions, both in 3D and 2D. The students presented their final projects in the classroom, and the teachers commented and evaluated them.

Finally, the students completed a small survey. The survey was designed as 11 Likert items, relative to four different topics. The students had to evaluate their degree of agreement with each sentence (from 1 -low- to 6 -high-). We have used the more suitable methodology (Jamieson, 2004) to analyze nominal Likert items: mode, median, inter-quartile range and nominal levels of disagree (degree of agreement of 1, 2 and 3) vs. agree (degree of agreement of 4, 5 and 6).

Additionally, the survey included two free-text items where the students could identify the strong and weak points of the software. We have analyzed these free-text items according to the *constant comparative method* (Strauss and Corbin, 1998), a methodology based on *grounded theory*

(Glaser and Strauss, 1967). In the first step, each student's response is decomposed in the ideas it expresses (*answers*). Then these answers are divided into *categories*. In the *phenomenological reduction phase*, the categories are grouped by subject (*themes*). Finally, in the *triangulation phase*, examples of *supporting quotes* are provided. The main advantage of using this methodology is that the ideas expressed in student's answers emerge from the analysis of the sentences, and are not pre-conceived by researchers. Therefore this analysis complements the results obtained in Likert-type surveys.

5. Results

In this section we will present the results obtained in the experiment. They have been organized into different subsections: student's survey, teacher's opinion and student's final projects. Finally, the last subsection is devoted to a global discussion in light of these three sources of evidence.

5.1 Student survey

As aforementioned, 78 students answered the survey. Results are summarized in Table 1, while Table 2 and 3 summarize the results of the two free text items (using the constant comparative method).

Table 1: Results of Likert items.

	1	2	3	4	5	6	MEDIAN	MODE	(Q ₁ ,Q ₃)	Don't agree	Agree
About the software tool...											
1. I quickly learned how to use the tool	0	3	4	3	41	27	5	5	(5,6)	8,97%	91,03%
2. It was easy for me to use the tool	0	0	2	10	32	34	5	6	(5,6)	2,56%	97,44%
3. The user interface is intuitive	1	3	12	30	20	12	4	4	(4,5)	20,51%	79,49%
4. The tool worked quick enough	1	4	17	24	22	10	4	4	(3,5)	28,21%	71,79%
5. The tutorial was easy to follow and useful	1	3	8	11	36	19	5	5	(4,5)	15,38%	84,62%
About the schemes proposed by the tool...											
6. The schemes can be helpful in the design process	4	12	17	27	14	4	4	4	(3,4)	42,31%	57,69%
7. The schemes can provide good starting points	2	9	8	25	29	5	4	5	(4,5)	24,36%	75,64%
8. The schemes were interesting	3	7	19	24	21	4	4	4	(3,5)	37,18%	62,82%
About this practice...											
9. All in one, it was interesting	3	5	7	27	29	7	4	5	(4,5)	19,23%	80,77%
10. I think that the methodology used was suitable	1	3	15	26	25	8	4	4	(4,5)	24,36%	75,64%
11. It was rewarding to work in groups	1	3	12	13	26	23	5	5	(4,6)	20,51%	79,49%

Table 2: Categories, themes and supporting quotes for positive aspects.

	CATEGORIES			THEMES	EXAMPLES OF SUPPORTING QUOTES
	Name	N° answers	% answers		
135 different answers	Diversity	26	19,26%	ASPECTS RELATIVE TO QUALITY OF SOLUTIONS (25,18%)	"Great variety of alternative solutions" "What I liked most about this practice is that I could develop a feasible project" "The tool provides a great variety of schemes, some of them present little annex spaces that could be grouped generating unexpected solutions"
	Validity	6	4,44%		
	Versatility for groupings	2	1,48%		
	Usability	3	2,22%	ASPECTS RELATIVE TO THE SOFTWARE TOOL (11,85%)	"The tool was easy to use" "The tool generated the schemes quickly and I could take advantage of some of them" "Being able to use new computational methods for architectural design based on randomness"
	Efficiency	10	7,41%		
	Possibility of using software tools in the design process	3	2,22%	TEAMWORK (14,82%)	"Working in groups and new relationships with other students" "Debates in the group about what is desirable or not in architectural design"
	Possibility of working in groups	10	7,41%		
	Processes of selection/reflection carried out in the working groups	10	7,41%	STARTING POINTS (48,15%)	"The tool provides a degree of randomness that would be otherwise difficult to include in a project" "Little annex spaces that appear accidentally can be used to generate diverse groupings" "Being able to have an starting point instead of a blank page" "The tool generates schemes that you would not think of"
	Randomness	9	6,67%		
	Happy accidents or bugs	3	2,22%		
	Provides starting points	41	30,37%		
	Overcoming preconceived solutions	12	8,89%		

Table 3: Categories, themes and supporting quotes for aspects to be improved.

102 different answers	Software capabilities for edition	9	8,82%	ASPECTS RELATIVE TO THE SOFTWARE TOOL (12,74 %)	"The user should be able to modify some aspects of the schemes generated" "A more intuitive interface"
	Usability (interface)	4	3,92		
	Shape grammar should include additional criteria	20	19,61%	ASPECTS RELATIVE TO SHAPE GRAMMARS (21,56%)	"Shape grammars should include additional architectural criteria" "To fully exploit the tool, the user should be able to define his/her own shape grammars"
	Possibility to include user-defined shape grammars	2	1,96%		
	Overlapping of non-specialized spaces	11	10,78%	ASPECTS RELATIVE TO DISTRIBUTION OF SPACES (17,64%)	"Overlapping of non-specialized spaces should be avoided" "Some kitchen modules are inaccessible" "The tool should not generate residual spaces" "The location of the entrance door near to the kitchen constrains the variety of the solutions" "Better distribution of spaces" "Wet zones should be contiguous"
	Bad distribution of kitchen furniture	3	2,94%		
	Residual spaces	10	9,8%		
	Better location of doors	12	11,76%		
	Better distribution of spaces	3	2,94%		
	Better placement of wet zones	10	9,80%		
	Excess of randomness	9	8,82%	ASPECTS RELATIVE TO THE SOLUTIONS (48,03%)	"The randomness of the tool should be controlled" "Greater variety of schemes generated" "Other parameters should be considered (environment, social aspects, etc.)"
	Poor variety of solutions	7	6,86%		
	Additional criteria should be considered (not only architectural)	2	1,96%		

As shown in Table 2 and 3, there were 135 different answers for the positive aspects, and 102 for aspects to be improved. From these answers, researchers established a total of 12 and 13 categories, respectively. Two independent researchers assigned quotes to categories. The inter-rater agreement between those two researchers was computed using the *iota* measure (Janson and Olsson, 2001). We obtained *iota* values of 0.707 and 0.898 (a value of 1 represents perfect agreement), which indicates a quite good agreement. Through a negotiation process between the two researches, answers were definitely assigned to categories. The final step of the triangulation process is the *interpretation* of the supporting quotes. In our case, this interpretation will be done in section 5.4, in which we use all the information available to establish some conclusions.

5.2 Teacher's opinion

Three architecture teachers participated in the experiment. One of them was a member of our research team, while the other two did not have previous knowledge of shape grammars or about the tool. We developed a small survey for these two teachers, which had four open questions. For space reasons we do not include their complete answer, but a brief summary of the more relevant information.

It seems that what the teachers liked most of this experience was the possibility to use this kind of tool and learn about shape grammars, together with the interdisciplinary work carried out by the research team and the fact that the tool can provide an unlimited number of schemes, and therefore expedite the design process. Overall, they said that the students had done a great job, and that the more interesting projects emerged from the accidental elements, like the little annex spaces generated in some of the automatic solutions presented by the software tool. More concretely, they said that... *"The tool expedited the design process. The most interesting projects have emerged from accidental elements, like annex spaces or errors. Initially, they seemed not to have any practical use, but finally they have served to encourage the clustering of the dwellings, and have provided support so the students could freely use their imagination. We do believe the tool has accelerated this kind of discoveries"*.

They also pointed out that the use of tool has provided an excellent exercise of analysis and reflection. The students have learned in a practical way that their preconceived ideas are not always the best ones. *"Having 81 housing plan floors automatically generated by the tool, so they could be discussed and selected by the groups of students, has been an excellent exercise about analysis/reflection, which is usually easier to carry out in other people's work than in our own designs. At the same time, the program generates such a wide variety of schemes that accidents occurred randomly, giving birth to what at first sight could be considered as undesirable forms, which finally generated the most interesting projects. Students have therefore learned in a practical way that their preconceived ideas are not always the more appropriate solutions"*.

As for possible improvements, they mentioned that it would be useful to include more architectural criteria in the shape grammars defined. *"In relation to the tool and its use in this particular*

activity, we think that it would be desirable to extend the number of variables to be taken into account in the shape grammar”.

5.3 Students final project

In the last session of the experiment, groups of students presented their final projects. Each group presented A1 sheets with the 81 schemes, evaluated from A (no changes needed) to E (the scheme is absurd). In total, there were 9 groups of 81 schemes. The distribution of the percentage of schemes classified according to the different grades (both among those produced by the students and among those generated automatically by BH-ShaDe) is shown in Figure 5.

In their presentations, the students stated that they had held very productive discussions to agree about criteria to classify schemes (recall that teachers also thought that this discussion/reflection process had been very productive). To this respect, some groups had established more demanding criteria than others. The teachers pointed out that some of them had discarded useful schemes for irrelevant reasons, such as a poor positioning of some elements (door, kitchen/bath furniture) or the superposition of non-specialized spaces. The high number of schemes classified with D and E can be explained by the fact that the students considered criteria (circulation, ventilation, light distribution or grouping of wet zones) not accounted in the guideline used by the tool.

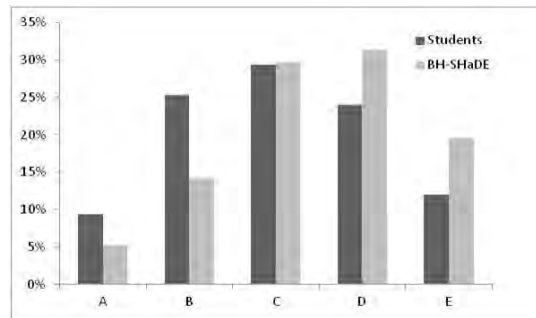

Figure 5. Distribution of the total percentage of schemes of each type (A to E)

From the schemes classified with A or B, each group selected four or five as the basis to create more complex structures. They explored different kinds of groupings: single-family houses, apartment blocks, galleries, etc.

There were many interesting projects, for illustration purposes we will show two of them (selected by the teachers as illustrative for different criteria). The teachers selected the first project as representative of those that emerged from starting points that contained accidental elements (and finally gave birth to creative solutions). This group used one of the schemes generated by the computer classified with A (upper left corner of the Figure 6). The scheme had two small corridors next to non-specialized spaces, and they decided to use these two corridors as terraces to generate an octahedron tower. The second project was chosen because it illustrated a nearly feasible solution (in teacher’s words, it seemed nearly pre-conceived). The students selected this scheme (right of the Figure 6 and also rated with A) because it has a good distribution of the so-called wet zones (kitchen and bathroom). In this way, once the schemes are grouped, wet zones occupy the central part of the building.

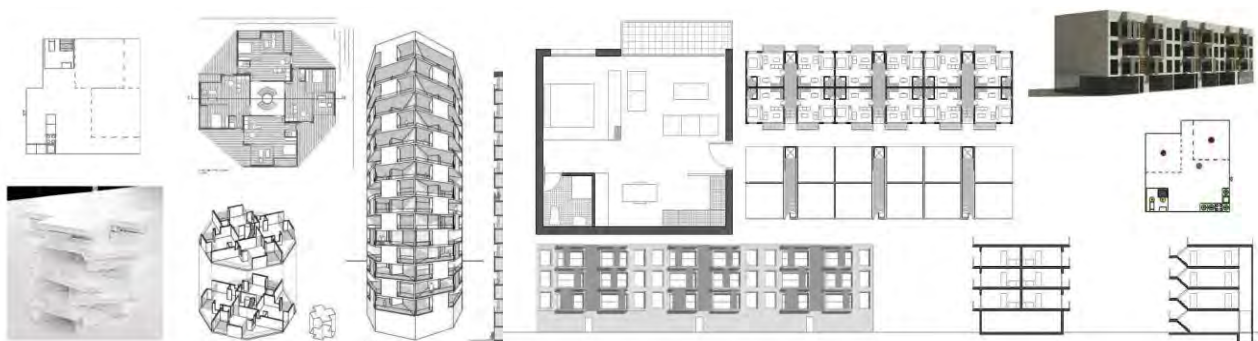

Figure 6. Examples of student’s projects: a) Octagonal tower and b) Gallery

5.4 Discussion

In this subsection we will use the results presented in sections 5.1, 5.2 and 5.3 to analyze to what extent the starting points provided by BH-Shade have been useful for the students in the early stages of their design projects.

With respect to this question, probably the more useful Likert items are items number 6, 7 and 8. In particular, item number 7 is very relevant, and we can see that 75,64% of the students agree that *“The schemes provided by the tool can provide good starting points”*. In addition, the students seem to agree that *“The schemes were interesting”* (62,82%), and that *“The schemes can be helpful in the design process”* (57,69%). This same conclusion can be reached from the analysis of the positive aspects of the first free-text item. Indeed, the theme *“Starting Points”* spontaneously emerged from student answers, being mentioned by 48,15% of the students, and specifically 30,37% of them mentioned that *“The tool provides good starting points”*. In this theme, other aspect mentioned by 8,89% of the students was the possibility of overcoming preconceived solutions. Teacher's feedback also seems to support this conclusion, because they said that *“However, the most interesting projects have emerged from accidental elements like annex spaces or errors”*. In fact, and according to their experience, *“the designs of the clusters of schemes obtained using traditional methods are usually more rigid and less creative than the ones generated with the tool”*.

Continuing with the positive aspects of the tool, the next more frequently mentioned theme in the survey was *“Aspects relative to the quality of solutions”* (25,28%), and in particular, the category *“Diversity”* (19,26%). As for the teachers, they declared that *“the program generates such high variety of schemes that accidents occurred randomly, giving birth to what at first sight could be considered as undesirable forms, but finally generate the most interesting projects”*. With respect to the tool, the students emphasized (7,41%) its *“Efficiency”* (also the teachers said *“The tool expedited the design”*).

All in one we think that, according to both the teachers and the students, the stronger point of BH-ShaDe is its capability to generate an unlimited number of diverse, feasible, random and suggestive starting points for novice designers.

With respect to aspects to be improved (and focusing our discussion in the quality of the starting points provided), the most frequently mentioned theme was *“Aspects relative to distribution of spaces”* (48,03%), and specifically the categories *“Better location of doors”* (11,76%), *“Overlapping of non-specialized spaces”* (10,78%), or *“Better placement of wet zones”* (9,8%). Next more frequently mentioned theme was *“Aspects relative to Shape grammars”* (21,56%), in particular, the category *“Shape grammars should include additional criteria”* (19,61%). Overall, it seems that both the teachers and the students think that the inclusion of additional architectural criteria (circulation, ventilation, illumination, grouping of wet zones...) could improve the quality of the solutions provided. Finally, and in relation with the overall quality of the starting points, Figure 5 shows that the students gave higher scores to their own designs than to those generated automatically by the tool. This suggests that future versions of the tool should offer a bigger degree of interactivity, allowing the user a greater control in the design of the initial scheme.

6. Conclusions and Future Work

In this paper, we have presented BH-ShaDe, an educational software tool that has been designed to help architectural students in early stages of design, by providing them with starting points for the design of residential projects. The tool is based on intelligent techniques, namely shape grammars and reinforcement learning.

In order to determine the usefulness of the tool we have conducted an experiment in the Architecture School of the University of Málaga. 78 students and three teachers participated in this experiment, which basically consisted in using BH-ShaDe to provide students with interactively and automatically generated schemes to help students to learn how to design dwellings and develop residential projects. Results of the experiment show that both the teachers and the students considered that the schemes provided by the tool were suitable, diverse and useful as starting points, and they had helped the students to develop creative and feasible solutions. Even in some cases, the schemes generated by the tool gave birth to more flexible and innovative projects than those generated with traditional methods.

Regarding future work, the more immediate step is to take into account the results of this study to improve the software tool. Some examples of these possible improvements are: increasing the degree of interactivity of the tool to allow users a greater control of the design process, or including additional architectural criteria in the shape grammar, to improve the quality of the starting points. Finally, we think that the approach exemplified in this work could be used in other design domains as support for the learning process.

Acknowledgements

This work is partially funded by: Grant TIN2009-14179 (Spanish Government, Plan Nacional de I+D+i) and PIE13-052 of the University of Málaga. We would like to thank the reviewers of the paper for their insightful comments.

References

- Cagdas, G. (1996). A shape grammar model for designing row-houses. *Design Studies* 17, 35-51
- Casakin, H. & Goldschmidt, G. (2000). Reasoning by visual analogy in design problem solving: the role of guidance. *Journal of Planning and Design: Environment and Planning B*, 27, 105-119.
- Chase, S.C. (2002). A model for user interaction in grammar-based design systems. *Automation in Construction* 11, 161-172.
- Demirkan H., & Afacan, Y. (2012). Assessing creativity in design education: Analysis of creativity factors in the first-year design studio. *Design Studies* 33, 262-278.
- Eckert, C. M., Stacey, M. K., & Clarkson, P. J. (2000). Algorithms and inspirations: creative reuse of design experience. *Proceedings of the Greenwich 2000 symposium: digital creativity*, 1-10.
- Elsen, C., & Leclercq, P. (2008). SketSha - the sketch power to support collaborative design cooperative design, visualization, and engineering. LNCS, vol. 5220. Springer Berlin, 20-27.
- Glaser, B.G., & Strauss, A. L. (1967). *The discovery of Grounded Theory*. Chicago IL: Aldine.
- Goldschmidt, G., & Smolkov, M. (2006). Variances in the impact of visual stimuli on design problem performance. *Design Studies* 27, 549-569.
- Iordanova, I., Tidafi, T., & Paoli, G. (2007). Is a Digital Model Worth a Thousand Pictures? *Computer-Aided Architectural Design Futures (CAADFutures)*, 85-98.
- Jain, A., Kensek, K., & Noble, D. (1998). An interactive web-based teaching tool for simplified 3D analysis of solar rhythms. *Automation in Construction* 8 (2), 181-194.
- Jamieson, S. (2004). Likert Scales: how to (ab)use them. *Medical Education*, 38 (12), 1212-1218.
- Janson, H. & Olsson, U. (2001). A Measure of Agreement for Interval or Nominal Multivariate Observations. *Educational and Psychological Measurement* 6 (2), 277-289.
- LeCuyer, A. (1996). Design on the computer. *Architectural Review*, January.
- Malaga, R.A. (2000). The effect of stimulus modes and associative distance in individual creativity support systems. *Decision Support Systems*, 29(2), 125-141.
- McGill, M.C. (2001). *A Visual Approach for Exploring Computational Design* (MSc Thesis).
- Montaner J.M. & Muxí, Z. (2008). Propuesta de nueva normativa de viviendas. Technical Report, Dirección general de ordenación del territorio, Junta de Andalucía.
- Peng, C., & Jones, P.B. (2004). Reconstructing urban contexts online for interactive urban designs. *Design Studies* 25 (2), 175-192.
- Redondo, E., Navarro, I., Sánchez, A., & Fonseca, D. (2011). Visual interfaces and user experience: Augmented reality for architectural education: One study case and work in progress. Vol. 166 of *Communications in Computer and Information Science*. Springer Berlin, Heidelberg, Ch. 31, pp. 355-367.
- Ruiz-Montiel, M., Boned, J., Gavilanes, J., Jiménez, E., Mandow, L., & Pérez-de-la-Cruz, J.L. (2013). Design with shape grammars and reinforcement learning. *Advanced Engineering Informatics*, Volume 27 2, 230-245
- Segers, N.M., de Vries, B., & Achten, H.H. (2005). Do words graphs stimulate design? *Design Studies* 26, 625-647.
- Simon, H.A. (1973). The structure of ill structured problems. *Artificial Intelligence* 4, 181-201.
- SketchUp (2013). <http://www.sketchup.com/>
- Stiny, G. (1980). Introduction to shape and shape grammars. *Environment and Planning B: Planning and Design* 7(3), 343-351.
- Strauss, A., & Corbin, I. (1998). *Basics of qualitative research: Grounded Theory procedures and techniques* (second edition). Thousand Oaks, CA: sage.
- Sutton, R.S., & Barto, A.G. (1998). *Reinforcement Learning: An Introduction*. MIT Press, Cambridge, MA

From Tutoring to Cognitive Rehabilitation: Exploiting CBM to Support Memory Training

Antonija MITROVIC^{a*}, Moffat MATHEWS^a, Stellan OHLSSON^b, Jay HOLLAND^a, Audrey MCKINLAY^c, Scott OGDEN^a, Anthony BRACEGIRDLE^a & Sam DOPPING-HEPENSTAL^a

^a*Intelligent Computer Tutoring Group, University of Canterbury, New Zealand*

^b*Department of Psychology, University of Illinois at Chicago, USA*

^c*Department of Psychology, University of Melbourne*

*tanja.mitrovic@canterbury.ac.nz

Abstract: Constraint-Based Modeling (CBM) is an effective student modeling approach which has been used successfully in a wide range of instructional domains. Within the Intelligent Computer Tutoring Group (ICTG), we have developed numerous constraint-based tutors and demonstrated their effectiveness in real courses. In this paper, however, we discuss how we use CBM in the area of cognitive rehabilitation after stroke. Our computer-based treatment is aimed at improving prospective memory. Participants are first trained on how to use visual imagery and then practice in a Virtual Reality (VR) environment. We present how we use constraints to track the participant's progress when performing tasks in the VR environment.

Keywords: constraint-based modeling, prospective memory, virtual reality environment

1. Introduction

Constraint-Based Modeling was originally proposed by Ohlsson (1992) as a way to overcome problems with student modeling. Since 1995, when the work on the first constraint-based tutor started, we have developed numerous tutors using CBM at ICTG (Mitrovic, 2012). Our early work focused on showing that CBM was an effective way of modeling domains and student knowledge. In order to develop SQL-Tutor, we proposed a number of extensions to CBM, including a way to develop long-term student models, the distinction between syntax and semantic constraints, and the use of ideal solutions in order to deal with multiple correct solutions (Mitrovic, 1998; Mitrovic & Ohlsson, 1999).

Many other constraint-based tutors followed after SQL-Tutor: some teach other design tasks, such as EER-Tutor (Suraweera & Mitrovic, 2004; Zakharov, Mitrovic & Ohlsson, 2005), UML class diagrams (Baghaei, Mitrovic & Irwin, 2007) and Java (Holland, Mitrovic & Martin, 2009). In addition to these design tasks which are all ill-defined (Mitrovic & Weerasinghe, 2009), we have also developed tutors that teach well-defined tasks, like NORMIT in the area of data normalization (Mitrovic, 2005), thermodynamics (Mitrovic et al., 2011), capital investment decision making (Mitrovic et al., 2009) and oil palm plantations management (Amalathas, Mitrovic & Ravan, 2012). We have investigated various types of long-term student models ranging from overlays to probabilistic ones (Mayo & Mitrovic, 2001), and investigated the effectiveness of various teaching strategies (Mitrovic, Ohlsson & Barrow, 2012; Mathews & Mitrovic, 2007; Weerasinghe et al., 2011; Najjar & Mitrovic, 2013). Over the years, our research focus expanded to other research challenges. We extended CBM to represent and support meta-cognitive skills such as self-assessment (Mitrovic & Martin, 2007) and self-explanation (Mitrovic, 2005; Weerasinghe & Mitrovic, 2006). We also developed COLLECT-UML which supports pairs of students working together and provides feedback on both problem solving and collaboration (Baghaei, Mitrovic & Irwin, 2007). We investigated affective modeling (Zakharov, Mitrovic & Johnston, 2008), and the use of data mining and eye-tracking to improve our ITSs (Elmadani, Mathews & Mitrovic, 2012; Mathews et al., 2012; Elmadani, Mitrovic & Weerasinghe, 2013).

We have also developed ASPIRE¹, a general authoring tool and deployment system for constraint-based tutors (Mitrovic et al., 2009). Many tutors have been developed in ASPIRE, by

¹ <http://aspire.cosc.canterbury.ac.nz/>

members of ICTG and researchers all over the world. CBM is now a thoroughly tested and widely used methodology; is not used solely by ICTG, but also by various groups of researchers worldwide – see e.g. (Rosatelli & Self, 2004; Riccucci et al., 2005; Petry & Rosatelli, 2006; Mills & Dalgarno, 2007; Siddappa & Manjunath, 2008, Menzel, 2006; Oh et al., 2009, Galvez, Conejo & Guzman, 2013; Le & Menzel, 2009; Roll, Alevén & Koedinger, 2010).

In our current project, however, we use CBM in a completely different situation. Since 2011, we have been developing computer-based training for improving prospective memory in stroke patients. People with brain injury (including stroke) have severely impaired prospective memory in comparison to healthy people (Mathias & Mansfield, 2005; Brooks et al., 2004). Prospective memory, or remembering to perform actions in the future, is of crucial importance for everyday life (Titov & Knight, 2000). Prospective memory failure can interfere with independent living, as it can result in forgetting to take medication, switch off the stove or missing doctor's appointments. It is a complex cognitive ability, which requires dynamic coordination of multiple cognitive abilities: spatial navigation, retrospective memory, attention and executive functioning (Knight & Titov, 2009).

We start by presenting related work in Section 2. Section 3 presents the treatment we devised: the visual imagery training, the VR environment and the constraints we developed to track the user's behavior in the VR environment. In Section 3, we also briefly present the evaluation study we are currently conducting. We conclude the paper with a discussion of future work.

2. Related Work

Stroke is the second leading cause of death² and a major contributor to disability. Cognitive impairment plays a crucial role in determining the broader outcomes of a stroke survivor (Barker-Collo et al., 2009). The extent of impairment affects aspects of daily functioning, and often necessitates constant care. Customised rehabilitation is required but is labor-intensive and expensive (Lee et al., 2010). Rehabilitation outcomes are disproportionate in many countries; for example, in New Zealand lower outcomes are achieved in low socio-economic, Māori, and Pasifika areas due to a lack of resources (Dyall et al., 2008; Ministry of Health, 2002).

Prospective memory is defined as the ability to remember future intentions (Ellis & Kvavilashvili, 2000). There are two critical aspects of PM: it is closely related to retrospective memory (remembering what was learnt and experienced previously), as it is necessary to know what the task is (e.g. taking medication at 3pm) in order to actually perform the task. The other aspect is the retrieval of the intention at the time appropriate for the action. There is a distinction between event- and time-based prospective tasks. In the case of a time-based task, a certain action needs to be performed at a certain time (e.g. having a doctor's appointment at 4pm). In event-based tasks, an action needs to be performed when a certain event happens (like asking a friend a question when we see them next time).

To be able to perform a task in the future, a person needs to know the task, a level of intention and a cue. Cues are prompts that help people remember the tasks to be performed in the future. When a person perceives a cue, it delivers the information that was previously associated with the cue to the consciousness, and the person remembers the task. Previous research indicates that cues help a person's memory as it reinforces the intention to execute a task (Gollwitzer, 1996).

Prospective memory is very difficult to assess using neuropsychological tests as conventional tests consist of simple, abstracted activities that are very different from real-world tasks. In order to assess prospective memory, it is necessary to obtain information about how a patient functions in everyday life, which is difficult to achieve in laboratory settings. Research shows that scores from neuropsychological tests often cannot be translated to conclusions about the level impairment and therefore rehabilitation goals because many conventional tests lack ecological validity (i.e. similarity with real life) (Knight, & Titov, 2009). It is therefore necessary to replace such tests with tasks that mirror real-world activities. However, assessing patients in real-world situations entails logistic problems and is not achievable in rehabilitation units (Brooks et al., 2004).

In the last decade, many research projects have used Virtual Reality (VR) in neuroscience research and therapy (Bohil, Alicea & Biocca, 2011), ranging from the use of VR for assessing cognitive abilities, over neuro- and motor rehabilitation to psychotherapy, such as treatment of phobias.

² <http://who.int/mediacentre/factsheets/fs310/en/>

VR environments are computer-generated environments that simulate real-life situations and allow users to interact with them. They provide rich, multisensory simulations with a high degree of control and rich interaction modalities. They can also have a high level of ecological validity. VR has been used for assessment of prospective memory in patients with traumatic brain injury (TBI) (Knight & Titov, 2009) and stroke patients (Brooks et al., 2004). VR is suited for prospective memory as it supports complex, dynamic environments that require coordination of many cognitive abilities. VR environments are convenient and safe for patients. Non-immersive, PC-based environments have been used more than the immersive ones, which require special hardware (such as head-mounted displays) and therefore are more expensive and induce more anxiety in patients than PC-based ones.

Although there has been some research done on how to assess PM, there is very little available on rehabilitation strategies for PM. Yip and Man (2013) involved 37 participants in 12 sessions (held twice a week) of prospective memory training using non-immersive VR. The participants were asked to perform a set of event- and time-based prospective memory tasks in parallel with an ongoing task, all performed in a virtual convenience store. The prospective memory training was based on remedial and process approaches. The remedial approach provides repetitive exercise within the VR environment. The process approach, on the other hand, aims to support multiple facets of prospective memory, and supports encoding of intention, retention and performance interval and recognition of cues. Participants were given a list of four shopping items they needed to memorize, and their recall was tested before entering the VR environment, where they needed to perform the tasks. The VR training showed significant improvement in participants' immediate recall of PM tasks, performance on both time- and event-based tasks as well as ongoing tasks, and also a significant improvement in self-efficacy.

3. Our Approach to Prospective Memory Training

The primary goal of our project is to develop an effective PM treatment that could be used by the stroke survivors without the input of clinicians. Our approach combines the use of visual imagery and practice in VR environments. We developed a treatment based on visual imagery, and a VR environment in which the patient will be able to improve their prospective memory. We start by describing the visual imagery training, and then present the VR environment, constraints used in the VR environment, and the evaluation study.

3.1 Visual Imagery Training

Visual imagery is a technique in which the participant forms a visualization of a given word. The same strategy can also be used to make a visualization of a pair of words, by linking the words and making the visualization as unusual as possible to make it more memorable. Previous work (Lewinsohn, Danaher & Kikel, 1977) has shown that visual imagery improves retrospective memory. McDaniel and Einstein (1992) showed that PM performance improved when participants were given pictures of targets, or when participants formed mental images of cues.

The idea behind the visual imagery training is to teach participants to remember a list of tasks with their associated cues using visual imagery as a mnemonic strategy. The training is presented on a computer in the form of a set of sequential pages. Pages contain recorded voice messages that participants can hear, images, video, written text, buttons to navigate to the previous and next pages, and a replay button. Sometimes participants are asked to interact with the page (e.g. during testing). On such pages, buttons are provided for the user to record the answers.

In the first phase of training, participants are introduced to visual mnemonics by being shown how to form mental images in order to remember a list of paired words. The user is presented with pairs of words and taken through creating the image for each pair. For example, for the pair (*rabbit, pipe*), the participant is first shown pictures of a rabbit and a pipe, and they listen to the recording of the following text: *Look at the image displayed of a rabbit. Imagine its bristly fur and its long ears wriggling. Really focus on it, like it's right there in front of you. Now look at the picture of a pipe. Imagine this in your mind. Smoke is coming out of the pipe, giving off a smoky smell. Imagine grasping the pipe, and feeling it. The pipe feels round and smooth in your hands. The more senses you use, the more memorable the image will be.*

The following training page (illustrated in Figure 1) shows the two previously shown pictures of a rabbit and a pipe, and also the combined picture, and plays the recording of this text: *Now that you have imagined the two images individually, we are going to visually link them together, which will help you to remember them. This technique of visually linking them together will allow you to recall the individual words in the future. So, what I want you to do right now is to imagine the rabbit smoking the pipe, like it is in the third image. Close your eyes and really think about it. The rabbit is puffing away and more and more smoke is coming out. In your mind, imagine the rabbit taking the pipe out and blowing a smoke ring and then putting it back in its mouth. What a silly rabbit! Ok, now open your eyes. Now that you've done this, the image of the rabbit smoking the pipe should be firmly in your memory, so that if we gave you the image of a rabbit, you would immediately think of it smoking a pipe, which will lead you to the second word: pipe!*

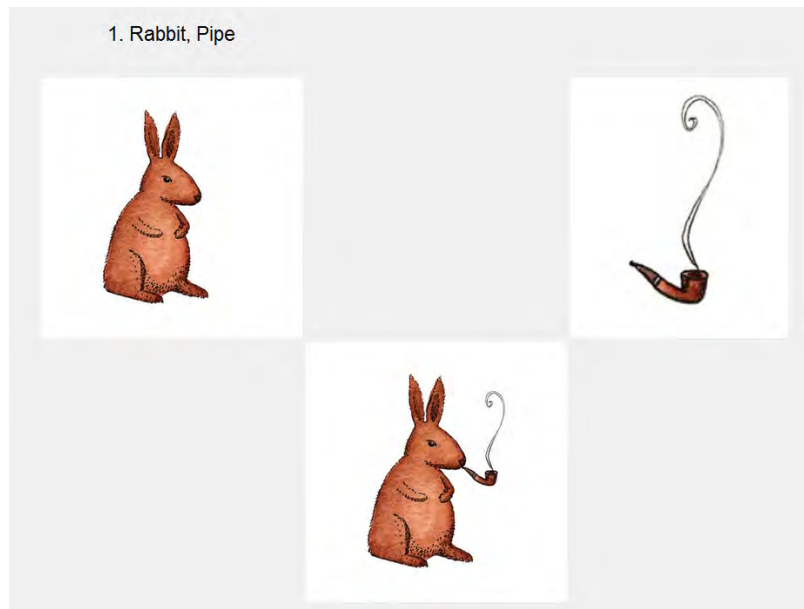

Figure 1: The screenshot of the training for the paired words *rabbit* and *pipe*

The audio instruction is designed to be as descriptive as possible in order to better aid the user's visualisation. The user is encouraged to mentally add to the presented images, personalizing them and making them more concrete. After presenting the initial three pairs of words, the user is tested by presenting one word from the pair and asking them to record the other paired word. Next, the user is presented five pairs at once, which he/she needs to visualize, and then the user is quizzed on them.

In the next phase, the training is modified by removing the combined picture, and asking the user to generate his/her own combined image. In the third phase, the training becomes even more demanding, as the user needs to visualize both given words as well as to generate the combination picture. The later phases provide the user with example tasks and show how, for each example task, the context could be related to the items to be done. The user is taught that each task consists of either object-action pairs or time-action pairs. An object-action pair is where some action is required when a certain object is encountered. A time-action pair is when some action is required at a particular time. An example of an object-action pair was then given: "Tell Laura about tomorrow's weather when you meet her next". The object in the pair is Laura and the action is to tell her about tomorrow's weather. Using this pair, a corresponding visual mnemonic could be made; for example, seeing Laura being swept up and carried by a tornado or the sun shining brightly out of Laura's head. Participants are taught that the more concrete (using real places, real people, real things, or real time) and more detailed a visual mnemonic was, the more personal and real it would be, and thus more memorable. The user is taught that the more silly or humorous a visual mnemonic was, the more memorable it would be.

In the last phase, the user is given lists of tasks to memorize, and then completes four problems. Each problem consists of watching a video containing the given tasks. During the video, when the user identifies the cue for a task, he/she needs to stop the video and record the action that corresponds to the cue, before carrying on with the video. They cannot rewind the video to enter in missed tasks.

3.2 VR Environment

We have developed a VR environment using the Unity game engine, in which the participants need to perform a given set of time- or event-based tasks. The VR environment represents a house with common household objects, and a garden. Figure 2 shows two scenes from the environment. The user is given a problem, which consists of several PM tasks they need to visualize first, and then perform in the VR environment. As discussed earlier, some tasks are time-based and the user is able to view a clock whenever they choose. The user is able to carry out a number of actions on a variety of objects such as a radio or a washing machine.

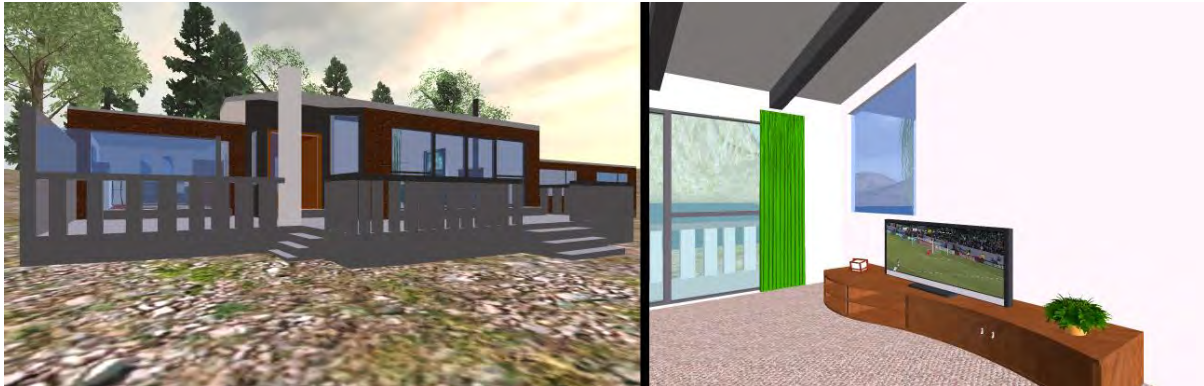

Figure 2: Two scenes from the VR environment

The tasks vary in complexity: the ones in early sessions consist of a cue and a single action, such as *Turn on the TV at 6pm*. In later sessions, the user will be given more complex tasks, such as *When the oven timer beeps, take the cake out of the oven and put it on the dining table*. To perform an action, the user needs to select the object first, and then to specify the action from a menu. The screenshot in Figure 3 shows a situation when the user is interacting with the oven. The selected object (oven in this case) is highlighted in red, and the user is given a menu listing the actions that can be performed on the object. In this particular situation, the user wants to take the cake out. Some tasks, such as taking the cake out of the oven, involve other objects, which are added to the inventory. Other tasks require inventory items to be collected beforehand. Consider the task *Take the white dress and iron it*. The first step involves collecting the inventory item *white dress*, while the second step involves operating the iron. The user is able to view their inventory at any time. The problems range in complexity: the initial ones contain only three simple tasks, and they become more complex as the user practices in the environment.



Figure 3: Two scenes from the kitchen

In order to be able to track the progress of the user, the system maintains the list of active tasks. Tasks should only be attempted from a point known as 'cue discovery'. Time-based tasks become active several minutes before the stated time. For example, if the task is *Turn on the radio at 6.00pm*, the user

can start to move towards the radio a few minutes earlier in preparation. Event-based cues only begin when the stated event occurs. Consider the task: *Bring in the washing when it starts raining*. For this task, the user has no way of knowing when it is going to rain, and so they should not begin the task before the cue is discovered.

For every task, there is a finite amount of time for which the task can be completed before it becomes obsolete or impossible. However, this alone is not the only factor in determining which tasks are more important. Some tasks, such as turning off the stove, have worse outcomes for failing to complete than other tasks do, such as turning on the TV. Each task therefore has a priority level, which is an integer from 0 to 5, with 5 representing the highest priority. Tasks with a level 5 priority are tasks with a very real chance of injury or household damage if they are not completed on time. A typical priority 5 task is *When the timer beeps, turn off the stove top*. By contrast, a priority 0 task may be: *When you are finished all other tasks, watch television*. From cue discovery, the user has a fixed time to complete the task before it becomes obsolete.

3.3 Using CBM for PM Training

We have developed a set of constraints that enable us to evaluate the participant's actions and provide feedback. As originally proposed by Ohlsson (1992), each constraint has two components: a relevance condition and a satisfaction condition. The relevance condition specifies features of situations for which the constraint is relevant, while the satisfaction condition details what must be true for the constraint to be satisfied. A constraint can be described as: *If <relevance condition> is true, then <satisfaction condition> had better also be true, otherwise something has gone wrong*. If a constraint is violated, the user needs some means of knowing that he/she has made a mistake, and they need to know what needs to be done differently next time. This is the role of feedback: it informs the user on what tasks need to be performed, and what objects need to be interacted with.

We have developed 15 constraints to track the user's progress within the VR environment. The constraints deal with navigation, prioritization of tasks, selection of objects to perform actions on, remembering/selecting actions to be performed and general skills of interacting with VR (such as selecting objects, selecting items from the menu or crouching). In order to be able to specify relevance and satisfaction conditions, we have defined a set of functions and predicates. For example, the *OnRouteTo* predicate takes the current position of the user (i.e. the room the user is currently in), the target position needed in order to perform the current task, and returns *True* if the current position is on a path to the target position. An example of a constraint where one object is required to perform action on another is:

*If the user has selected an action for Object X which requires Object Y,
Then Object Y should be in the inventory.*

Each constraint contains three feedback messages. When a constraint is violated for the first time, the user will be given a general message, in order to remind them that they have missed something. For example, if the user is going in the opposite direction from the target destination, he/she will be given feedback "*You're going the wrong way!*" If the user continues down the wrong path, the feedback for to the second violation of the same constraint becomes more specific: "*Perhaps you should be going to the [goalRoom]*" ([goalRoom] is a function which returns the position for the current task). This culminates on their third violation of the constraint with "*You should be going to the [goalRoom] and use the [goalObjects]*". This is the bottom-out feedback which instructs the user what to do. Figure 4 illustrates a situation when the user tried to put a white dress on the clothes line, but forgot to collect the dress beforehand.

Three constraints check whether the user is working on the correct task. Tasks with only one minute left should be done before tasks with more than one minute left, even if that task with more than one minute left is of higher priority. In this way the user can still complete all the tasks. It is also important to bear in mind that higher priority tasks will reach the point of only having one minute left a lot sooner than a lower priority task. If there are multiple tasks with less than one minute left, the user should choose the highest priority one. The next threshold is at five minutes. Users must do tasks with less than five minutes left before they attempt tasks with more than five minutes left. As discussed in the previous section, tasks are first stratified according to time left into less than one minute, less than five

minutes, more than five minutes. From there they are ranked according to priority. If any tasks have equal time strata and priority, they can be done in any order, otherwise the user must pick the top one.



Figure 4: A screenshot showing feedback from a violated constraint

In addition to the feedback being displayed during the session, the user can also press the H key for more help. If the user has had a message displayed in the last 30 seconds, this message is displayed again to remind them of what they were doing wrong. Otherwise the default message is displayed. If there are no tasks left to do, the default feedback informs them of this. Otherwise it gives them increasingly specific hints as to what they should be doing.

In our previous work with ITSs, constraints are evaluated when the student submits the solution, therefore requiring feedback from the system. The timing of constraint evaluation in the VR environment differs from this: there is no time when the user explicitly requires feedback. On the contrary, the system needs to be able to evaluate constraints when appropriate. The constraints that deal with task prioritization are evaluated at intervals of 0.5s. Other constraints are evaluated in the appropriate contexts: for example, navigation constraints are evaluated every time the user changes room, while constraints that deal with objects are evaluated when the user selects an object or an action.

We have conducted a case study with a stroke survivor, who used the VR environment for 30 minutes. The participant could interact with the environment, and the case study identified a few usability issues and further improvements to the timing and duration of feedback. We then had a domain expert interact with the system. The domain expert explored the virtual environment completing a number of tasks. The domain expert was able to compare the feedback generated by constraints with the feedback they expected from the system. All constraints were satisfied or violated as expected, and these results were recorded faithfully by the user model. At some points, the feedback actually led to the domain expert making more errors. In such situations, the user was alerted that they should be doing one of several tasks, and told all the tasks currently available. When the user completed the lowest priority of these tasks, they violated the constraint that they should be doing the most high priority tasks. This led to the recommendation that feedback messages should only suggest the single most important task at the current time. The findings were then used to improve the constraint set and the system.

3.4 Evaluation Study

We are currently conducting an evaluation study of our computerized treatment with stroke patients. The study consists of ten sessions. In session 1, the participants will be tested to determine the level of cognitive functioning by performing a battery of cognitive tests, including the digit span test, the CAMPROMPT test of PM and the visual imagery questionnaire. Throughout the study, the participants are asked to keep a diary of their activities, and note PM tasks they have managed or failed to complete in their everyday activities. The diary will be discussed at the beginning of each session.

The second session is scheduled 4 weeks after the first session, so that it is possible to track the PM skills after this initial period. Starting from the second session, there are two one-hour-long sessions per week, for four weeks. The participant undergoes visual imagery training (discussed in Section 3.1) in sessions 2-4, followed by videos in sessions 5 and 6. In sessions 4 and 5, the participant is also introduced to the VR environment so that they can become familiar with it and also get used to using the joystick. The next stage of the study (sessions 6-9) is practice in the VR environment. The participant will be given 3-4 problems per session. At the end of session 9, the participant will again undergo the PM assessment. This assessment will allow us to measure the effectiveness of the treatment. Finally, the last session will be held after 4 weeks, and will consist of repeated assessment of the participant's PM. We will then analyze the results to determine whether the expected improvement in PM skills holds over the 4 weeks since session 9.

4. Conclusions and Future Work

In previous research, constraint-based modeling has been used to develop domain and student models in intelligent tutoring systems. CBM has been proven to be an effective student modeling approach that is applicable in a wide range of instructional domains. In this paper, we describe how we have used CBM in order to track the user's prospective memory. We have presented a computer-based treatment for improving prospective memory for stroke survivors. Our treatment consists of training users on how to use visual imagery to improve their memorization skills. Later on, participants practice using visual imagery by interacting with videos and a VR environment.

The contribution of this research is in extending constraint-based modeling from modeling and supporting cognitive skills to modeling and supporting prospective memory skills. We have developed a constraint set that allows us to track the user's behavior in the VR environment. The constraints identify whether the user is prioritizing the tasks correctly, whether there are any problems with navigation, identifying cues (time or event ones), interacting with objects and specifying actions. The pilot study performed with one stroke survivor was promising. Three domain experts have interacted with the VR environment and expressed satisfaction with the feedback the system provides. We are currently conducting a full study, aiming to have a group of 20 stroke patients to undergo all the phases of our treatment.

Acknowledgments

This research was supported by a grant UOC1004 from the Marsden Fund of the Royal Society of New Zealand. We would like to thank all members of ICTG, and the participants in our study.

References

- Amalathas, S., Mitrovic, A., & Ravan, S. (2012) Decision-Making Tutor: Providing on-the-job training for oil palm plantation managers. *Research and Practice in Technology-Enhanced Learning*, 7(3), 131-152, APSCE.
- Baghaei, N., Mitrovic, A., & Irwin, W. (2007). Supporting collaborative learning and problem-solving in a constraint-based CSCL environment for UML class diagrams. *International Journal of Computer-Supported Collaborative Learning*, 2(2-3), 159-190.

- Barker-Collo, S. L., Feigin, V. L., Lawes, C. M., Parag, V., Senior, H., & Rodgers, A. (2009). Reducing Attention Deficits After Stroke Using Attention Process Training A Randomized Controlled Trial. *Stroke*, 40(10), 3293-3298.
- Bohil, C. J., Alicea, B., & Biocca, F. A. (2011). Virtual reality in neuroscience research and therapy. *Nature reviews neuroscience*, 12(12), 752-762.
- Brooks, B. M., Rose, F. D., Potter, J., Jayawardena, S., & Morling, A. (2004). Assessing stroke patients' prospective memory using virtual reality. *Brain Injury*, 18(4), 391-401.
- Dyall, L., Feigin, V., Brown, P., & Roberts, M. (2008). Stroke: A picture of health disparities in New Zealand. *Social Policy Journal of New Zealand*, 33, 178.
- Ellis, J., & Kvavilashvili, L. (2000). Prospective memory in 2000: Past, present, and future directions. *Applied Cognitive Psychology*, 14(7), S1-S9.
- Elmadani, M., Mathews, M., & Mitrovic, A. (2012). Data-driven misconception discovery in constraint-based intelligent tutoring systems. In G. Biswas, L-H. Wong, T. Hirashima, W. Chen (Eds.) *Proc. 20th Int. Conf. on Computers in Education*, (pp. 9-16), APSCE.
- Elmadani, M., Mitrovic, A., & Weerasinghe, A. (2013) Understanding student interactions with tutorial Dialogues in EER-Tutor. L. H. Wong, C-C Liu, T. Hirashima, P. Sumedi, M. Lukman (Eds.) *Proc. 21st Int. Conf. on Computers in Education*, Bali, (pp. 30-40). Uhamka Press.
- Gálvez, J., Conejo, R., & Guzmán, E. (2013). Statistical Techniques to Explore the Quality of Constraints in Constraint-Based Modeling Environments. *International Journal of Artificial Intelligence in Education*, 23(1-4), 22-49.
- Gollwitzer, P. M. (1996). The volitional benefits of planning. *The psychology of action: Linking cognition and motivation to behavior*, 13, 287-312.
- Holland, J., Mitrovic, A., & Martin, B. (2009). J-LATTE: a Constraint-based Tutor for Java. In: Kong, S.C., Ogata, H., Arnseth, H.C., Chan, C.K.K., Hirashima, T., Klett, F., Lee, J.H.M., Liu, C.C., Looi, C.K., Milrad, M., Mitrovic, A., Nakabayashi, K., Wong, S.L., Yang, S.J.H. (Eds.) *Proc. 17th Int. Conf. Computers in Education* (pp. pp. 142-146), Asia-Pacific Society for Computers in Education.
- Knight, R. G., & Titov, N. (2009). Use of virtual reality tasks to assess prospective memory: Applicability and evidence. *Brain impairment*, 10(01), 3-13.
- Le, N. T., & Menzel, W. (2009). Using Weighted Constraints to Diagnose Errors in Logic Programming—The Case of an Ill-defined Domain. *International Journal of Artificial Intelligence in Education*, 19(4), 381-400.
- Lee, H. C., Chang, K. C., Huang, Y. C., Lan, C. F., Chen, J. J., & Wei, S. H. (2010). Inpatient rehabilitation utilization for acute stroke under a universal health insurance system. *Am J Manag Care*, 16(3), e67-e74.
- Lewinsohn, P. M., Danaher, B. G., & Kikel, S. (1977). Visual imagery as a mnemonic aid for brain-injured persons. *Journal of Consulting and Clinical Psychology*, 45(5), 717.
- Mathews, M., & Mitrovic, A. (2007). The Effect of Problem Templates on Learning in Intelligent Tutoring Systems. In R. Luckin, K. Koedinger, J. Greer (eds) *Proc. 13th Int. Conf. Artificial Intelligence in Education AIED 2007*, (pp. 611-613).
- Mathews, M., & Mitrovic, A. (2009). Does framing a problem-solving scenario influence learning? In: Kong, S.C., Ogata, H., Arnseth, H.C., Chan, C.K.K., Hirashima, T., Klett, F., Lee, J.H.M., Liu, C.C., Looi, C.K., Milrad, M., Mitrovic, A., Nakabayashi, K., Wong, S.L., Yang, S.J.H. (Eds.) *Proc. 17th Int. Conf. Computers in Education*, (pp. 27-34) APSCE.
- Mathews, M., Mitrovic, A., Lin, B., Holland, J., & Churcher, N. (2012). Do your eyes give it away? Using eye tracking data to understand students' attitudes towards open student model representations. In *Intelligent Tutoring Systems* (pp. 422-427). Springer Berlin Heidelberg.
- Mathias, J. L., & Mansfield, K. M. (2005). Prospective and declarative memory problems following moderate and severe traumatic brain injury. *Brain Injury*, 19(4), 271-282.
- Mayo, M., & Mitrovic, A. (2001). Optimising ITS behaviour with Bayesian networks and decision theory. *Artificial Intelligence in Education*, 12(2), 124-153.
- McDaniel, M. A., & Einstein, G. O. (1992). Aging and prospective memory: Basic findings and practical applications. *Advances in learning and behavioral disabilities*, 7, 87-105.
- Menzel, W. (2006). Constraint-based Modeling and Ambiguity. *Artificial Intelligence in Education*, 16(1), 29-63.
- Mills, C., & Dalgarno, B. (2007). A conceptual model for game-based intelligent tutoring systems. *Proceedings of the 2007 Australasian Society for Computers in Learning in Tertiary Education*, 692-702.
- Ministry of Health New Zealand (2002). Modelling Stroke - A multi-state life table model *Public Health Intelligence Occasional Bulletin* (Vol. 12).
- Mitrovic, A. (1998). Experiences in implementing constraint-based modeling in SQL-tutor. In: B. Goettl, H. Half, C. Redfield, V. Shute (Eds.) *Intelligent Tutoring Systems* (pp. 414-423). Springer Berlin Heidelberg.
- Mitrovic, A. (2005). The Effect of Explaining on Learning: a Case Study with a Data Normalization Tutor. In C-K Looi, G. McCalla, B. Bredeweg, J. Breuker (Eds.) *Proc. Conf. Artificial Intelligence in Education* (pp. 499-506).

- Mitrovic, A. (2012). Fifteen years of constraint-based tutors: what we have achieved and where we are going. *User Modeling and User-Adapted Interaction*, 22(1-2), 39-72.
- Mitrovic, A., & Martin, B. (2007). Evaluating the effect of open student models on self-assessment. *International Journal of Artificial Intelligence in Education*, 17(2), 121-144.
- Mitrovic, A., Martin, B., Suraweera, P., Zakharov, K., Milik, N., Holland, J., & McGuigan, N. (2009). ASPIRE: an authoring system and deployment environment for constraint-based tutors. *International Journal of Artificial Intelligence in Education*, 19(2), 155-188.
- Mitrovic, A., & Ohlsson, S. (1999). Evaluation of a constraint-based tutor for a database language. *Artificial Intelligence in Education*, 10(3-4), 238-256.
- Mitrovic, A., Ohlsson, S., & Barrow, D. K. (2013). The effect of positive feedback in a constraint-based intelligent tutoring system. *Computers & Education*, 60(1), 264-272.
- Mitrovic, A., & Weerasinghe, A. (2009). Revisiting ill-definedness and the consequences for ITSs. In: V. Dimitrova, R. Mizoguchi, B. du Boulay, A. Graesser (Eds.) *Proc 14th Int. Conf. Artificial Intelligence in Education* (375-382).
- Mitrovic, A., Williamson, C., Bebbington, A., Mathews, M., Suraweera, P., Martin, B., Thomson, D., & Holland, J. (2011). Thermo-Tutor: An intelligent tutoring system for thermodynamics. In *Global Engineering Education Conference (EDUCON), 2011 IEEE* (pp. 378-385). IEEE.
- Najar, A. S., & Mitrovic, A. (2013, January). Examples and Tutored Problems: How Can Self-Explanation Make a Difference to Learning? In *Artificial Intelligence in Education* (pp. 339-348). Springer Berlin Heidelberg.
- Ohlsson, S. (1992). Constraint-based student modeling. *Artificial Intelligence in Education*, 3(4), 429-447.
- Petry, P. G., & Rosatelli, M. C. (2006). AlgoLC: a learning companion system for teaching and learning algorithms. In: M. Ikeda, K. Ashley, T.-W. Chan (Eds.), *Intelligent Tutoring Systems* (pp. 775-777). Springer Berlin Heidelberg.
- Riccucci, S., Carbonaro, A., & Casadei, G. (2005). An Architecture for Knowledge Management in Intelligent Tutoring System. In *Proc. IADIS Int. Cong. Cognition and Exploratory Learning in Digital Age* (pp. 473-476).
- Roll, I., Alevin, V., & Koedinger, K. R. (2010). The invention lab: Using a hybrid of model tracing and constraint-based modeling to offer intelligent support in inquiry environments. In *Intelligent Tutoring Systems* (pp. 115-124). Springer Berlin Heidelberg.
- Rosatelli, M. C., Self, J. A., & Thiry, M. (2000). LeCS: a collaborative case study system. In *Intelligent Tutoring Systems* (pp. 242-251). Springer Berlin Heidelberg.
- Siddappa, M., & Manjunath, A. S. (2008). Intelligent tutor generator for intelligent tutoring systems. In *Proceedings of World Congress on Engineering and Computer Science* (pp. 578-583).
- Suraweera, P., & Mitrovic, A. (2004). An intelligent tutoring system for entity relationship modelling. *International Journal of Artificial Intelligence in Education*, 14(3), 375-417.
- Titov, N., & Knight, R. G. (2000). A procedure for testing prospective remembering in persons with neurological impairments. *Brain Injury*, 14(10), 877-886.
- Weerasinghe, A., & Mitrovic, A. (2006). Facilitating deep learning through self-explanation in an open-ended domain. *International Journal of Knowledge-Based and Intelligent Engineering Systems*, 10(1), 3-19.
- Weerasinghe, A., Mitrovic, A., Thomson, D., Mogin, P., & Martin, B. (2011). Evaluating a general model of adaptive tutorial dialogues. In *Artificial Intelligence in Education* (pp. 394-402). Springer Berlin Heidelberg.
- Yip, B. C., & Man, D. W. (2013). Virtual reality-based prospective memory training program for people with acquired brain injury. *NeuroRehabilitation*, 32(1), 103-115.
- Zakharov, K., Mitrovic, A., & Ohlsson, S. (2005). Feedback micro-engineering in EER-Tutor. In *Proc. Artificial Intelligence in Education*, (pp. 718-725). IOS Press.
- Zakharov, K., Mitrovic, A., & Johnston, L. (2008). Towards emotionally-intelligent pedagogical agents. In *Intelligent Tutoring Systems* (pp. 19-28). Springer Berlin Heidelberg.

Ontological Descriptions of Statistical Models for Sharing Knowledge of Academic Emotions

Keiichi MURAMATSU^{a*}, Tatsunori MATSUI^a

^a*Faculty of Human Sciences, Waseda University, Japan*

*kei-mura@ruri.waseda.jp

Abstract: Many studies have been conducted during the last two decades examining learner reactions within e-learning environments. In an effort to assist learners in their scholastic activities, these studies have attempted to understand learner mental states by analyzing participants' facial images, eye movements, and other physiological indices and data. To add to this growing body of research, we have been developing IMS (Intelligent Mentoring System) which performs automatic mentoring by using an ITS (Intelligent Tutoring System) to scaffold learning activities and an ontology to provide a specification of learner's models. To identify learner mental states, the ontology operates based on theoretical and data-driven knowledge of emotions. In this study, we use statistical models to examine constructs of emotions evaluated in previous psychological studies, and then produce a construct of academic boredom.

Keywords: Ontology, academic emotions, academic boredom, constructs

1. Introduction

During the last two decades, studies have been conducted that examine semiconscious behaviors of learners participating in e-learning environments by observing and analyzing facial images, eye movements, and other physiological indices. Analysis of data obtained from such examinations enables researchers to understand various mental states of learners, such as that of "confidence" and "confusion" (Arroyo et al., 2009; Muldner et al., 2009). In addition, studies have employed the intelligent tutoring system to evaluate the structural features of the knowledge learners possess. As a result of these studies, researchers have developed an intelligent mentoring system (IMS) that supports learning based on the various aspects of mental states and knowledge (Kojima et al., 2012; Muramatsu et al., 2012; Muramatsu et al., 2013). One of its main characteristics is diagnostic function of learner model considering mental states of learners. Because mental states can instantly change in a short activity (e.g., solving of a single problem), IMS is required to monitor learners at all time and give feedback based on diagnosis. The IMS provides integrative learning-support including real-time estimation of learners' mental states and selection of ways to support learners, in addition to diagnosis of learners' knowledge structures and determination of teaching strategies provided by ITS (Intelligent Tutoring System). In the IMS, data from interactions between users and the system are captured according to two levels of cognitive activity: high-level interactions (HLI) and low-level interactions (LLI). HLI examine a user's explicit awareness of scholastic activities and illustrates it by means of a data resource that employs large grain samples. By contrast, LLI examine user's diffuse awareness to a limited extent and illustrates it by means of a data resource that uses much smaller grain samples.

Muramatsu et al. (2012) developed an ontology that provides descriptions of the relationships among LLI resources and the mental states of learners. These descriptions are based on specific tasks performed by learners, which are independent of the knowledge structures examined within specific domains which they learn about. Muramatsu et al. (2013) expanded the ontological descriptions pertaining to mental states based on concepts of academic emotions (Pekrun et al. 2002) and the control-value theory (Pekrun 2006). These descriptions help to clarify relationships between academic emotions and subjective attributes that perform the role of subjective control or value in accordance with the control-value theory. Their ontology effectively illustrates how academic emotions are formed during co-occurrence of control and value, and it has helped researchers interpret learners' mental states based on LLI resources in the IMS. However, the descriptions provide insufficient detail to identify

subcategories of attributes that perform a role of control or value in practical settings. The subcategories derive from experiments that measure emotions using rating scales and statistical analyses of the measured data. To implement the IMS, ontological descriptions about academic emotions should include both data-driven and theoretical knowledge. The academic emotions are student's emotions experienced in academic settings such as class-related, learning-related and test-related situations (e.g. boredom experienced in classroom instruction, enjoyment of learning and test anxiety).

This study makes a conceptualization of statistical models such as the factor analysis model used in psychological research. Specifically, we describe the structure of rating scales that express psychological attributes as representations, and specify relationships among variables that represent the psychological attributes in statistical models. Finally, we demonstrate ontological descriptions in constructs of academic emotions.

2. Emotions in Academic Settings

In the field of psychology, learner emotions, specifically within the context of classroom instruction and achievement, are referred to as academic emotions (Pekrun et al., 2002). Emotions related to achievement are defined as achievement emotions and are measured by using the achievement emotions questionnaire (Pekrun et al., 2011). This questionnaire consists of scales related to nine emotions: enjoyment, boredom, anger, hope, anxiety, hopelessness, pride, relief, and shame. These nine emotions can be subdivided into two types according to their object focus: (1) activity emotions, which pertain to ongoing achievement-related activities, and (2) outcome emotions, which concern the outcomes of these activities. Enjoyment, boredom, and anger constitute activity emotions. The outcome emotions include *prospective* outcome emotions such as hope, anxiety, and hopelessness, as well as *retrospective* outcome emotions such as pride, relief, and shame.

Academic emotions are explained by referring to the control-value theory proposed by Pekrun (2006). This theory describes emotions as sets of interrelated psychological processes composed primarily of affective, cognitive, motivational, and physiological dimensions (Pekrun et al., 2011). The theory appraises the subjective control and subjective value. The appraisal of subjective control relates to perceived control of achievement-related actions and outcomes. By contrast, the appraisal of subjective value pertains to the subjective importance of achievement-related activities and outcomes.

In e-learning environments, learning materials such as multiple-choice tests are considered as "object focuses," and activity emotions such as enjoyment, boredom, and anger can arise in such settings. For example, when a learner's mental states are estimated as "interesting" and "comprehending," enjoyment is expected to be the academic emotion experienced. In this situation, the quality of "interesting" has a subjective value, which includes a quality value of positive or negative, because subjective evaluation on the quality of "interesting" correlates to a positive/negative affection (Acee et al., 2010). However, when an activity involves a learning material that lacks incentive value, whether positive or negative, boredom is the expected result. The incentive value of an activity may depend on the control that is perceived by the learner (Pekrun, 2006).

According to research on the construct of academic boredom, a learner's perceptions of boredom also represent a situation-dependent construct (Acee et al., 2010). Specifically, over-challenging situations lead learners to either "task-focused" or "self-focused" boredom, while under-challenging situations lead to more general boredom. In the research of Acee et al., the academic boredom scale (ABS) was used to measure learners' emotions. The ten items in ABS (ABS-10) consist of unipolar scales that correspond to ten psychological attributes, which are listed as follows: "want something else," "tired of activity," "impatient," "frustrated/annoyed," "apathetic," "nothing to do," "activity dull," "repetitive," "wonder why doing this," and "useless/unimportant." As a result of a factor analysis of data related to under-challenging situations, all items in the ABS-10 scale were correlated to general boredom. By contrast, a factor analysis of data related to over-challenging situations correlated five psychological attributes ("want something else," "tired of activity," "impatient," "frustrated/annoyed," and "apathetic") to self-focused boredom. The other five attributes ("nothing to do," "activity dull," "repetitive," "wonder why doing this," and "useless/unimportant") were correlated to task-focused boredom. Because the variables derived from these factor analyses yield psychosocial attributes

measured through the use of rating scales, the relationships among them provide a construct of academic emotions and their subcategories.

3. Method for Ontology Development

3.1 Role Concept

Ontological engineering is a field of computer science that supports the systematic description of knowledge. From this knowledge-based perspective, "ontology is defined as a theory (system) of concepts/vocabulary used as building blocks of an information processing system (Mizoguchi et al., 1995)." In Hozo¹ ontology editor which is one of ontology development environment, each node represents a whole concept and contains slots that represent part-of or attribute-of relations (Fig. 1).

Hozo helps describe role concepts wherein a role depends on the contents of each whole concept. For example, a teacher's role is played only in the context of school. Every slot thus has a role within a whole concept that implies a context. In the context, a class of instances that can play a role is defined by a class constraint and is called a role holder (Kozaki et al., 2000). In this way, the role concept distinguishes between concepts within different contexts. Inherited role holders and class constraints imported from other ontologies are shown in the right half of Figure 1.

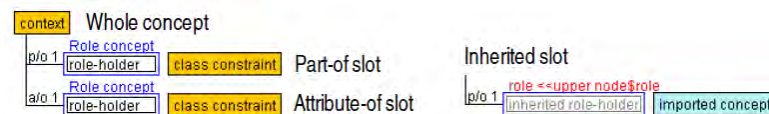

Figure 1. Legend.

3.2 Top-level Ontology

Mizoguchi (2010) constructed a top-level ontology based on the role concept theory known as “yet another more advanced top-level ontology” (YAMATO²). Based on YAMATO, an entity is divided into three classes: physical, abstract, and semi-abstract. Although instances of a physical class require 3D space and time to exist, instances of an abstract class require neither. Instances of a semi-abstract class require only time to exist, and the class contains mind, representation, content, and a representation form.

Representations such as novels, poems, paintings, music, and symbols are distinguished from their propositions and forms of representation (Mizoguchi, 2004). A class of representation is further divided into primitive representation and composite representation. The composite representation has one or more part-of slots which indicates that a subsidiary role is played by a representation. The representation contains part-of slots that indicate a content role played by a proposition and a form role played by a representation form. The proposition is divided into two classes: representation-primary and representation-secondary. For example, “content of a piece of music” and “content of a novel” are examples of the former and “content of a fact recognized by a human” is an example of latter. These classes necessarily depend on their representation. However, instances of a representation-secondary class, such as facts, data, and thoughts, indicate original content that should be represented. For example, a fact designated as an event exists before it can be recognized and expressed as a representation. In this sense, the process of human recognition, which necessarily includes sensations and perceptions, belong to the representation-secondary class.

The main features of YAMATO are definitions of qualities and quantities, their representations, and descriptions of their interrelationships in other top-level ontologies. Attributes of entities are represented as qualities comprised of quality values. A quality value is divided into a class of “categorical” and a quantity contains a quantitative quantity and a qualitative quantity. A quality is divided into a property and generic quality, with the property being an abstraction of the generic quality

¹ <http://www.hozo.jp>

² http://www.ei.sanken.osaka-u.ac.jp/hozo/onto_library/upperOnto.htm

but possessing a quality value. The generic quality is divided into intrinsic generic quality and accidental generic quality. A subclass of intrinsic generic quality is basic generic quality, which contains quantitative generic quality and qualitative generic quality.

In YAMATO, a representation of a quality is distinguished from a real quality which exists with an entity. Therefore, representations of qualities and quantities are defined as transformations of real quality through an “action to measure.” The measure contains a part-of slot that indicates a “result” role played by a primitive representation. A quality measurement is defined as a role-holder performed by a proposition in a content role subplot of the result role slot. Through measurements, data are approximation of real qualities and a quality value representing a true value is independent of any measurements. Therefore, representations of a quality must be distinct from representations of a quality obtained through measurements (Masuya et al., 2011).

4. Ontological Descriptions

4.1 Subjective Measurement

In psychometric methods that use rating scales, subjective evaluations of emotions are often expressed as points on a scale. The *rating scale* and *point on rating scale* are displayed in Figure 2. A point on the rating scale has a form slot that is filled by a *word* or *pictogram* and contains an additional slot in which a number represents a scale marking. The rating scale is a composite representation comprised of multiple points. Two points are considered *anchor* role-holders in which a *pole* subplot indicates a perceptual large or small point.

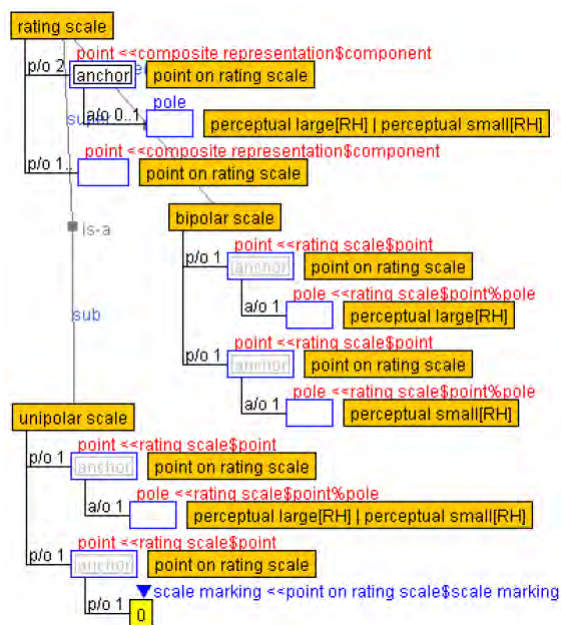

Figure 2. Rating Scale and its Points.

Semantic differential scales contain adjective pairs that represent perceptual qualities, each of which indicates large or small perceptual quality values. Thus, the relationship of magnitude among perceptual quality values can be defined through the rating scale. Furthermore, *unipolar* and *bipolar scales*, defined as subclasses of the rating scale, contain unipolar and bipolar perceptual qualities, respectively.

4.2 Statistical Models

To show relationships between measured data of emotions in subjective ways, statistical models are often adopted in psychological research. In this study, we employed unique mathematical models as well as mathematical and quality data expressions (Fig. 3) in the composite representation in

YAMATO. The *mathematical model* contains a *mathematical expression* slot inherited from the *composite* and *quality data* slot. Each role of the slots employs a mathematical expression and *quality data representation*. In the mathematical model, the content of the quality data is defined as a *modeled attribute value*, while the mathematical expression is composed of multiple *variables* inherited from the *component* slot and *constant* slot. The variable role contains a representation and coefficient performed by a number defined as a subplot.

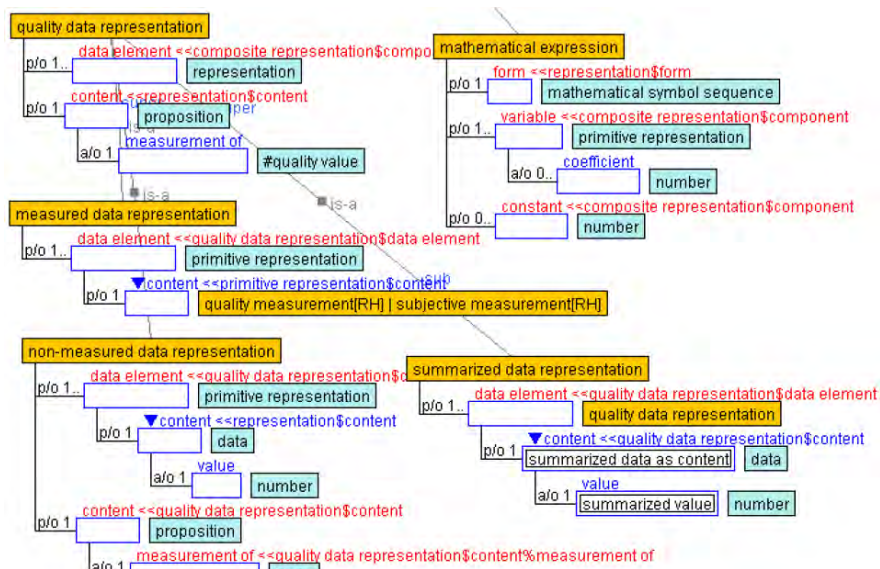

Figure 3. Mathematical Model and its Components.

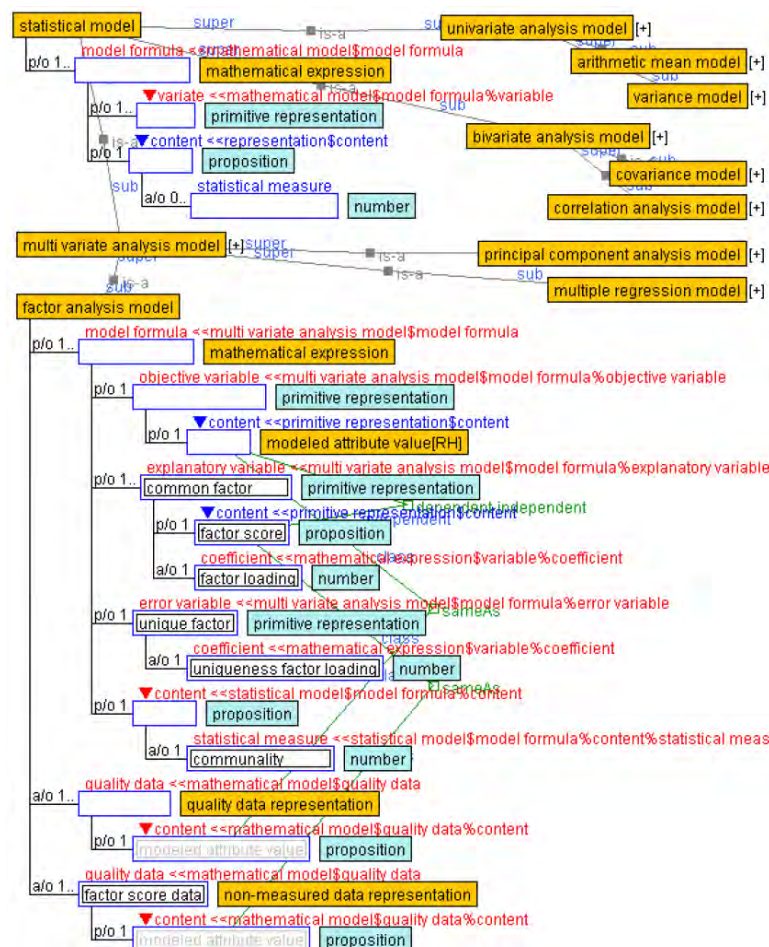

Figure 4. Classes of Statistical Models.

The quality data representation contains multiple *data element* role slots performed by other representations. The content role slot is performed by the data and the *measurement of* the subplot indicates the derivation. The quality data representation is divided into *measured data representation*, *non-measured data representation*, and *summarized data representation*. In the measured data representation, the content is performed by the quality measurement or subjective measurement, which indicates quality value as a proposition. However, the content of the non-measured data representation such as factor scores and principle component scores exists only in mathematical models. The summarized data representation is composed of data elements played recursively by the quality data representation, and its content is regarded as *summarized data as content*, which represents a summarized value such as an average.

Figure 4 displays the hierarchy of statistical models and their subclasses. The statistical model is divided into a *univariate analysis model*, *bivariate analysis model*, and *multivariate analysis model* by cardinality of the quality data representation slot. The univariate and bivariate analysis models employ summary statistics such as arithmetic mean, variance, covariance, and correlation. Multivariate analyses such as multiple regression, factor analysis, and principle component analysis are defined as subclasses of the multivariate analysis model. Objective and explanatory variables are described in a *model formula* slot and have a “dependent-independent” link to indicate their correspondences. The data to be assigned to the variables is described by a “same as” link between the content slots of variables and the data representations.

5. Discussion and Conclusion

In this section, we discuss the validity and utility of the ontological descriptions discussed in the previous section through a demonstration of the construct of academic boredom. The results of a factor analysis conducted by Acee et al. (2010) indicate that academic boredom is comprised of multidimensional and situation-dependent constructs. First, some items on the ABS-36 are correlated to negative and positive values. Second, all items on the ABS-10 are correlated to general boredom in under-challenging situations. The ABS-10 consists of ten items representing ten psychological attributes: “want something else,” “tired of activity,” “impatient,” “frustrated/annoyed,” “apathetic,” “nothing to do,” “activity dull,” “repetitive,” “wonder why doing this,” and “useless/unimportant.” Third, in over-challenging situations, five psychological attributes (“want something else,” “tired of activity,” “impatient,” “frustrated/annoyed,” and “apathetic”) are correlated to self-focused boredom, whereas the remaining five attributes (“nothing to do,” “activity dull,” “repetitive,” “wonder why doing this,” “useless/unimportant”) are correlated to task-focused boredom.

This construct of academic boredom is represented in Figure 5 and, as a subclass of the factor analysis model, is further defined in Figure 4. Model formulae given in mathematical expressions (Fig. 3) are defined as *Negative Affect-related Expression* and *Positive Affect-related Expression* role holders, which indicate relations between object variables and factors. The object variables contain a content slot used by a *modeled attribute value*, which is defined as a proposition of a quality data representation (Fig. 3). This means that the modeled attribute value refers to a quality value measured with a rating scale (Fig. 2). Therefore, correlations between some items of the academic boredom scale and negative/positive values are adequately described.

The constructs of boredom in under- and over-challenging situations are represented in Figure 5. In the *Construct of Academic Boredom in Under-challenging situation*, the modeled attribute value that is correlated to the *General Boredom Factor* refers to a quality value measured with a rating scale. Types of qualities are specified by the role player in the *measurement of* role slot. For example, a quality measured by the ABS-10 such as “want something else,” “tired of activity,” or “impatient” can play the role. Similarly, modeled attribute values in the *Construct of Academic Boredom in Over-challenging situation* also refer to qualities measured by the ABS-10.

This study conceptualized the three features of the boredom construct derived from the factor analysis conducted by Acee et al. (2010). However, two issues remain. First, qualities measured by items in the ABS lack sophistication. Second, the construct of academic boredom is uncertainly positioned in the description of statistical models. In this study, we provided an adequate description of relationships between modeled attribute values and quality values measured with rating scales.

However, we did not address modeled values described by the rating scales, a topic that we hope to examine in the future. Furthermore, we offered tentative descriptions of the constructs of academic boredom and positioned them in the statistical models. The concepts related to these constructs fundamentally differ from general statistical models. In other words, the constructs should be conceived in ways similar to learner models, for example. We addressed these unresolved matters in this study.

Our ontology will enable researchers to better interpret their results and share their findings. The descriptions we provide of constructs of academic boredom can help researchers acquire knowledge about associations between academic emotions and psychological attributes. Because the descriptions provided in the current study derives from only single study, their capability and range of application are confined to a construct of the academic boredom from a viewpoint of a few researchers. However, basic forms of statistical models which represent the constructs of academic emotions are common in psychology. Thus the current study just proposed the descriptions as a framework of the knowledge sharing on academic emotions. In future work, we extend our descriptions of constructs to include various academic emotions studied in educational psychology, and conduct practical assessments of their validity and utility through an implementation of IMS.

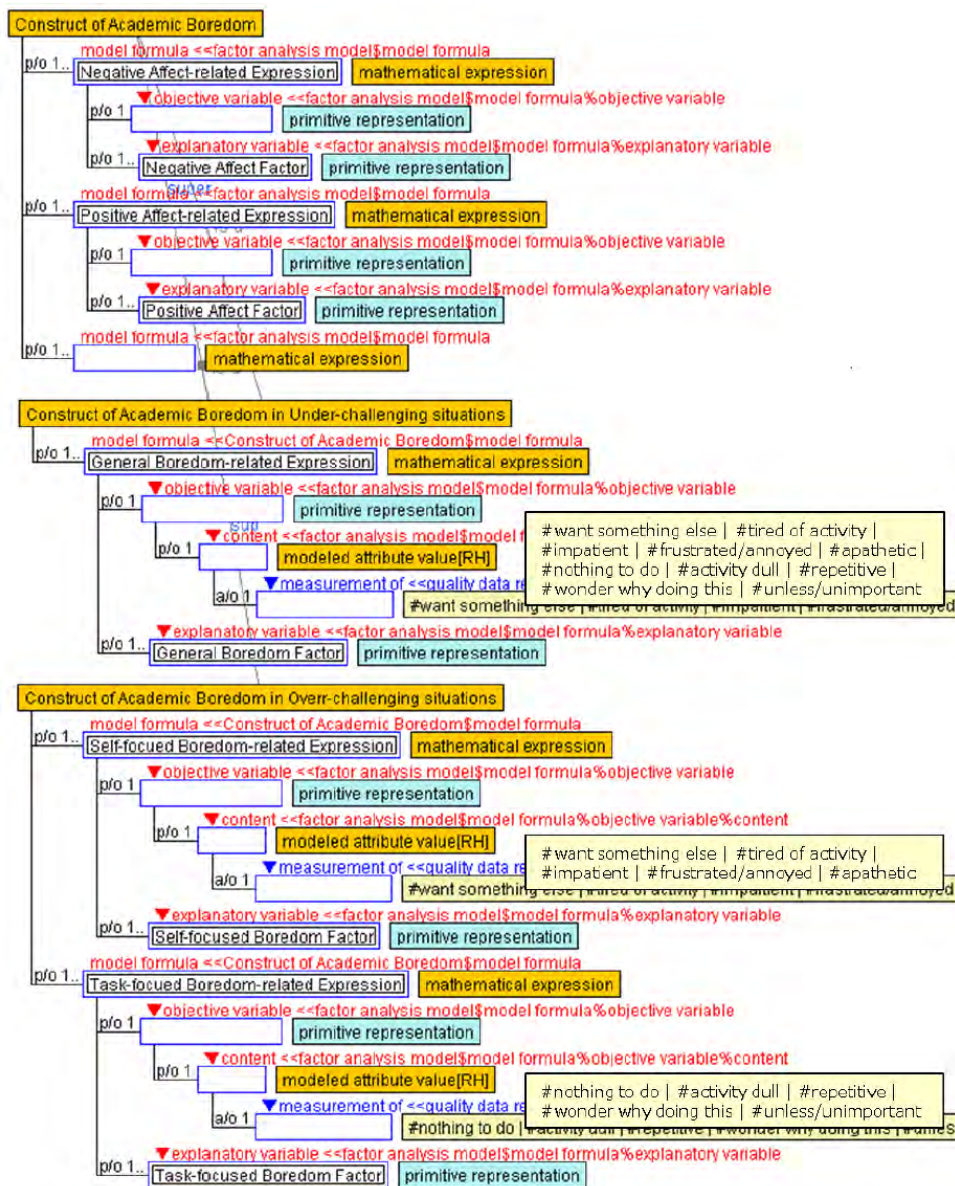

Figure 5. Construct of Academic Boredom.

Acknowledgements

This work was supported by JSPS KAKENHI Grant Number 25730170.

References

- Acee, T. W., Kim, H., Kim, H. J., Kim, J., Hsiang-Ning, R. C., Kim, M., The Boredom Research Group (2010). Academic Boredom in Under- and Over-challenging Situations, *Contemporary Educational Psychology*, 35(1), 17-27.
- Arroyo, I., Cooper, D. G., Burleson, W., Woolf, B. P., Muldner, K., Christopherson, R. (2009). Emotion Sensors Go To School. In Dimitrova, V., Mizoguchi, R., Boulay, B., Graesser, A. C. (Eds.), *Proceedings of the 14th International Conference on Artificial Intelligence in Education* (pp. 17-24). Brighton, UK: IOS Press.
- Kojima, K., Muramatsu, K., & Matsui, T. (2012). Experimental Study toward Estimation of a Learner Mental State from Processes of Solving Multiple Choice Problems Based on Eye Movements. In G. Biswas et al. (Eds.), *Proceedings of 20th International Conference on Computers in Education*, (pp. 81-85). Singapore: Asia-Pacific Society for Computers in Education.
- Kozaki, K., Kitamura, Y., Ikeda, M., Mizoguchi, R. (2000). Development of an Environment for Building Ontologies Which is based on a Fundamental Consideration of "Relationship" and "Role". In Compton, P., Hoffmann, A., Motoda, H., Yamaguchi, T. (Eds.) *Proceedings of the Sixth Pacific Knowledge Acquisition Workshop* (pp. 205-221). Sydney, Australia: University of New South Wales.
- Masuya, H., Gkoutos, G. V., Tanaka, N., Waki, K., Okuda, Y., Kushida, T., Kobayashi, N., Doi, K., Kozaki, K., Hoehndorf, R., Wakana, S., Toyoda, T., Mizoguchi R. (2011). An Advanced Strategy for Integration of Biological Measurement Data. In Bodenreider, O., Martone, M. E., Ruttenberg, A. (Eds.), *Proceedings of the 2nd International Conference on Biomedical Ontology* (pp. 79-86), Buffalo, NY: CEUR Workshop Proceedings.
- Mizoguchi, R., Vanwelkenhuysen, J., Ikeda, M. (1995). Task Ontology for Reuse of Problem Solving Knowledge. In Mars, N. J. I. (Eds.), *Proceedings of Knowledge Building & Knowledge Sharing 1995* (pp. 46-59). Enschede, Netherlands: IOS Press.
- Mizoguchi, R. (2004). Tutorial on Ontological Engineering - Part 3: Advanced Course of Ontological Engineering. *New Generation Computing*, 22(2), 193-220.
- Mizoguchi, R. (2010). YAMATO: Yet Another More Advanced Top-level Ontology. In Taylor K., Meyer, T., & Orgun M. (Eds.), *Proceedings of the Sixth Australasian Ontology Workshop* (pp. 1-16) Sydney: ACS.
- Muldner, K., Christopherson, R., Atkinson, R., Burleson W. (2009). Investigating the Utility of Eye-Tracking Information on Affect and Reasoning for User Modeling. In Houben, G.-J., McCalla, G. I., Pianesi, F., & Zancanaro M. (Eds.), *Proceedings of the 17th International Conference on User Modeling, Adaptation and Personalization* (pp. 138-149). Trento, Italy: Springer
- Muramatsu, K., Kojima, K., Matsui, T. (2012). Ontological Descriptions for Eye Movement Data and Mental States in Taking Computer-based Multiple-Choice Tests. In G. Biswas et al. (Eds.), *Proceedings of 20th International Conference on Computers in Education*, (pp. 33-40). Singapore: Asia-Pacific Society for Computers in Education.
- Muramatsu, K., Kojima, K., Matsui, T. (2013). Ontological Organization of Academic Emotions toward Knowledge Description and Management about Learners Mental States. In Wong, L.-H. et al. (Eds.) *Proceedings of the 21st International Conference on Computers in Education* (pp. 145-150). Indonesia: Asia-Pacific Society for Computers in Education.
- Pekrun, R., Goetz, T., Titz, W., Perry, R. P. (2002). Academic Emotions in Students' Self-Regulated Learning and Achievement: A Program of Qualitative and Quantitative Research. *Educational Psychologist*, 37(2) 91-105.
- Pekrun, R. (2006). The Control-Value Theory of Achievement Emotions: Assumptions, Corollaries, and Implications for Educational Research and Practice. *Educational Psychology Review*, 18(4), 315-341.
- Pekrun, R., Goetz, Frenzel, A. C., Barchfeld, P., Perry, R. P. (2011). Measuring Emotions in Students' Learning and Performance: The Achievement Emotions Questionnaire (AEQ). *Contemporary Educational Psychology*, 36(1), 36-48.

Scaffolding for Self-overcoming of Impasse by Using Problem Simplification

Naoya HAYASHI^{a*}, Tomoya SHINOHARA^a, Sho YAMAMOTO^a, Yusuke HAYASHI^a,
Tomoya HORIGUCHI^b & Tsukasa HIRASHIMA^a

^a*Graduate School of Engineering, Hiroshima University, Japan*

^b*Faculty of Maritime Sciences, Kobe University, Japan*

* naoya@lel.hiroshima-u.ac.jp

Abstract: As a support for learners who failed to solve a problem, teaching the way to solve the problem is a general method. However, in order to realize active learning, it is a desirable way to let learners overcome the impasse of the problem solving by themselves. Because it is usually difficult for the learners to do it by themselves, we have proposed “problem simplification” that is a way to find a simplified problem that is included in the original problem from the viewpoint of problem solving. If the simplified problem can be solved by the learner, the difference between the simplified one and the original one is the origin of the impasse. To make clear the origin of the impasse is feasible scaffolding for self-overcoming of impasse. In this paper, firstly we propose a framework to define simplification of problems in elementary mechanics in high school. Then, it is introduced a support system for self-overcoming of impasse of problem solving using the problem simplification targeting elementary mechanics. We also report a practical use of this system in classes of a technical high school.

Keywords: Problem Simplification, Self-overcoming, Impasse, elementary mechanics

1. Introduction

Problem exercise is an indispensable step in learning of physics, mathematics and so on. When a learner engages in the problem exercise, the learner usually has enough knowledge to solve the problems in the exercise. However, the learner often fails to solve a problem because it is difficult for the learner to use knowledge adequately to solve the problem. In such case, to explain how to solve the problem is a standard method in usual teaching. This method is effective to let the learner solve the problem. However, because the learner often accepts the way to solve the problem passively, it is not effective as learning. In order to use failure of problem solving as an opportunity of learning, it is desirable to let the learner to overcome the failure or impasse of the problem solving by him/herself (Polya, 1945; Perkinson, 1984). In this paper, targeting elementary physics, we propose “problem simplification” to support a learner to overcome his/her impasse in problem solving by him/herself.

Even if a learner cannot solve a problem in an exercise, the learner usually has almost enough knowledge to solve the problem. Then, a few elements including the problem often cause the difficulty for the learner to solve it. In such case, it is possible to expect that the learner can solve a problem generated by deleting the elements in the original problem by him/herself. If the simplified problem is solved, it is possible to specify the cause of the difficulty for the learner as the difference between the original problem and the simplified problem. When a learner to engage in a new and difficult problem, it has been confirmed that to make clear the difference between the difference between the new problem and the problems that have been already solved is a promising way (Sheiter and Gerjets, 2002; Sheiter and Gerjets, 2003). Therefore, in the case of impasse of problem-solving, we assumed that such simplified problems are useful to overcome the impasse in solving the original problem. If the learner can solve the original problem after solving the simplified problem, the learner was supported but didn't teach the way to solve the original problem. So, we call this process “self-overcoming of Impasse”.

In order to use the simplified problem in problem exercise, however, it is necessary to generate the simplified problem from the original one. Therefore, in this research, we define “problem simplification”. Simplified problems used in the process should be included in the original problem from the view point of problem solving. The definition of the simplification is carried out based on

Microworld Graph describing simplification-complication relations between physical situations (Horiguchi and Hirashima, 2005; Horiguchi and Hirashima, 2009).

We have already implemented a system that support a learner in impasse of problem solving by using problem simplification targeting physics of high school. Because the system is implemented on tablet PC, it is possible to use the system in a usual classroom. We have already conducted practical use of the system in physics class in a technical high school. 130 students in three classes were used the system in one class time (45 minutes). Almost of them could use the system smoothly and we found behavior of self-overcoming of impasse from more than half of them. Also to other students, we could find focused their weak points.

This paper describes description of each problem and relations between problems in Section 2. The problem simplification supporting for Self-overcoming of impasse is explained in Section 3. This paper also reports a practical use of this system in classes of a technical high school and its results in Section 4.

2. Derivative Problem

As shown in Figure 1, previous research has defined the elementary mechanics problem as “situation” and “solution” (Okawachi, Ueno and Hirashima, 2012). Problems defined based on the situation, and the situation has attributes, such as gravitational acceleration and mass, and operational relations which is the relationship among attributes. The solution is defined by connecting attributes given in a problem sentence by means of operational relations defined in the situation. We call it solution structure (Hirashima, Kashihara and Toyoda, 1995). This is a tree structure composed of input attributes which are leaf nodes, output attribute which is a root node, derived attributes which are the others nodes, formula nodes which connect their attributes, and edges. Input attributes is attributes explicitly given in a problem sentence (blue nodes in Figure 1), output attribute is attribute which learners should seek by connecting input attributes (red node in Figure 1), and derived attributes is attributes which learners acquired in the middle of solving the problem (green nodes in Figure 1). How to the read solution structure in Figure 1 is that firstly “ G_y ” (gravitation of block A in vertical direction) is derived from “ m ” (mass of the object) and “ g ” (acceleration of the gravity) which are input attributes, using formula node “gravitation of block A (vertical)”, then “ N ” (normal force) is derived from “ G_y ” using formula node “normal force”, then “ f ” (dynamic friction) is derived from input attribute “ μ ” and derived attribute “ N ” using formula node “dynamic friction”, and lastly output attribute “ F_x ” (resultant of block A in parallel on the surface) derived from derived attribute “ f ” and input attribute “ T_x ” using formula node “resultant of block A (parallel on the surface)”.

We call the problem which has relevance from a viewpoint of the situation or the solution, "derivative problem" (Okawachi, Ueno and Hirashima, 2012). Automatic generation function of the formalized derivative problems had already been developed in the previous research. In the following subsections, the two types of derivative problems are explained.

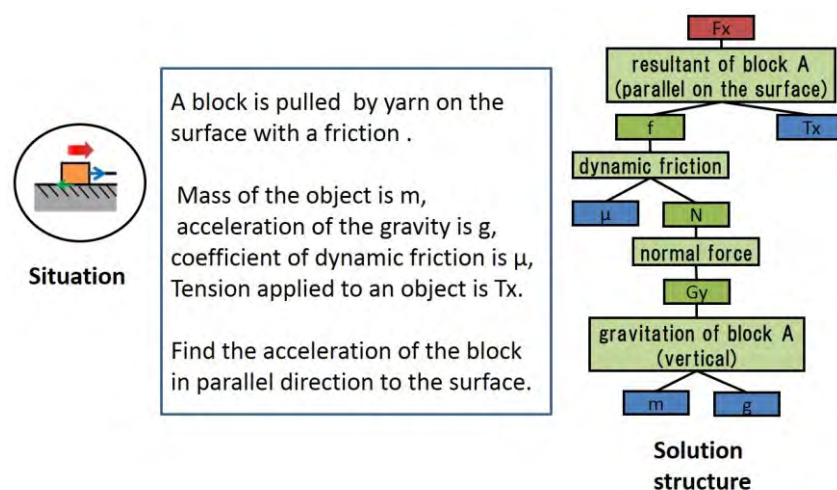

Figure 1. Problem and Solution Structure.

2.1 Specialized/Generalized Problem

A specialized problem is generated by specialized a certain attribute, such as an angle of inclination and friction coefficient, which the situation of a certain problem has. This problem has simpler situation than original problem has. The specialization is making a certain attribute into a specific value. The solution of the specialized problem does not change from the solution of the original problem. Therefore, this problem is included by the original problem from the viewpoint of problem solving, so if learners can solve the original problem, they can inevitably solve the specialized problem.

A generalized problem is generated by adding a certain attribute to the situation of a certain problem. This problem has more complex situation than original problem has. The generalization is the opposite of specialization. The generalized problem includes the original problem from the viewpoint of problem solving, so if learners cannot solve the original problem, they cannot inevitably solve the generalized problem.

We use a model called a micro world graph for transition of the situation. This graph is comprehensively described situations which are derived from a certain situation (Hirashima, et al, 1994; Horiguchi and Hirashima, 2009).

2.2 Partialized /Expanded Problem

A partialized problem has a part of solution structure of a certain problem as a solution of this problem. This problem is generated by making derived attribute input attribute, or derived attribute output attribute. Thus, extracting a part of solution is called the partialization. The partialized problem is included by the original problem from the viewpoint of problem solving, so if learners can solve the original problem, they can inevitably solve partialized problem.

An expanded problem is generated by making input attribute derived attribute, or output attribute derived attribute. The expansion is the opposite of partialization. The expanded problem includes the original problem from the viewpoint of problem solving, so if learners cannot solve the original problem, they cannot inevitably solve expanded problem.

3. Problem Simplification Strategy

3.1 A Summary of Problem Simplification Strategy

One of a purpose of the problem exercises is finding where learners reach an impasse in problem solving. For this purpose, when learners cannot solve a certain problem, they need to recognize the origin of the impasse. In order to have learners recognize it, let us use the following idea. Considering a problem structurally, the problem is made by complicating “a situation” or “a solution” of the simplest problem derivatively. Therefore, more complex problem includes simpler problem from the viewpoint of problem solving, and if learners can solve more complex problem, they inevitably can solve simpler problem. According to this idea, we can consider that problems are made hierarchically. We call this idea “Derivative Establishment Model of the Problem”.

Considering problems as things with such relationship, we can say that when a learner cannot solve a certain problem, he/she cannot solve the part in this problem, not the entire. Taking a difference between problem which a learner cannot solve and simpler problem which a learner can solve, this difference is the origin of the impasse in solving the problem which a learner cannot solve and the part which they should overcome. Based on this idea, if learners cannot solve a certain problem, the problem is simplified until they find a problem which they can solve. After they find the problem which they can solve, taking a difference between the original problem which they couldn't solve and the simplified problem which they could solve, they can recognize the origin of the impasse in solving the original problem. We call this strategy “Problem Simplification Strategy”. Although it is difficult for learners to consider combining the simplified problem and the difference as learners return to the original problem from the simplified problem, they can easily recognize their origin of the impasse, comparing to usual exercise. We assume that learners may overcome their impasse of the original problem which they

couldn't solve by themselves without some teaching activities, by tackling the problem with their being conscious of their origin of the impasse and recognizing the relationship of the problems, because learners usually have enough knowledge to solve the problems in the exercise. On the other hand, if they cannot overcome their impasse of original problem, they lead to efficient learning by learning again focusing on their origin of the impasse.

"The Problem Simplification Strategy" has two functions which get learners to recognize the difference between the problem which they couldn't solve and the problem which they could solve. One is "the Difference Extract Function", and the other is "the Difference Connect Problem". We describes these functions in 3.2 and 3.3.

3.2 Difference Extract Function

In problem simplification strategy, the learning environment sets learners simpler problem by only one step when they cannot solve a problem. If they can solve the simpler problem, they tackle again the original problem by only one step. Since the simplified problem which a learner could solve and original problem which a learner couldn't solve have strong relationship, they are expected to tackle the original problem using simplified problem. However, for this purpose, they need to recognize the relationship of the problems. Therefore, by lining up the simplified problem which a learner could solve and the original problem which a learner couldn't solve and highlighting difference between those, the learning environment has learners be conscious of the difference. This function is called "a Difference Extract Function". By using this function, the learners may be able to be not only aware of difference between the simplified problem which they could solve and the original problem which they couldn't solve, but also may be able to solve the original problem by using simplified problem.

3.3 Difference Connect Problem

We can assume that there are learners who cannot overcome the impasse in solving the original problem, even if they use "a Difference Extract Function". In this case, the learning environment set them "a Difference Connect Problem". This problem is a problem which connects the simplified problem which they could solve and the original problem which they couldn't solve.

It is assumed that a problem which a learner couldn't solve has a part which they cannot solve somewhere in a solution. Because the difference connect problem has such part as a solution of this problem, this problem is a problem which connects a solution of problem which a learner could solve and a solution of problem which a learner couldn't solve. The solution of this problem is generated by taking the difference of the solution of problem which a learner could solve and problem which a learner couldn't solve, i.e., solution structure of problem which a learner could solve and problem which a learner couldn't solve. Although the difference connect problem is one of a partialized problem, unlike usual partialization, partialization in generating the difference connect problem is performed so as to focus on the part which they cannot solve in a solution. We assume that if learners recognize where the part as their origin of the impasse is and connect this part and problem which they could solve, they can solve problem which they couldn't solve. If learners cannot overcome their impasse in solving problem which they couldn't solve through "Difference Extract Function", the learning environment sets them "a Difference Connect Problem".

If learners cannot solve "a difference connect problem", this problem is specialized/ partialized based on "Problem Simplification Strategy". By repeating this, they can find the part which they cannot solve more appropriately.

There are three kinds of the difference connect problem as follows. In case the relation between problem which a learner could solve and problem which a learner couldn't solve is partialization and expansion, the difference connect problem is (1) a problem whose solution is lost by partialization (Figure2). In case the relation between problem which a learner could solve and problem which a learner couldn't solve is specialization and generalization, the difference connect problem is (2) a problem which have learners derive attribute omitted by specialization (Figure3 (a)), and (3) a problem which have learners use operational relation changed by specialization (Figure3 (b)).

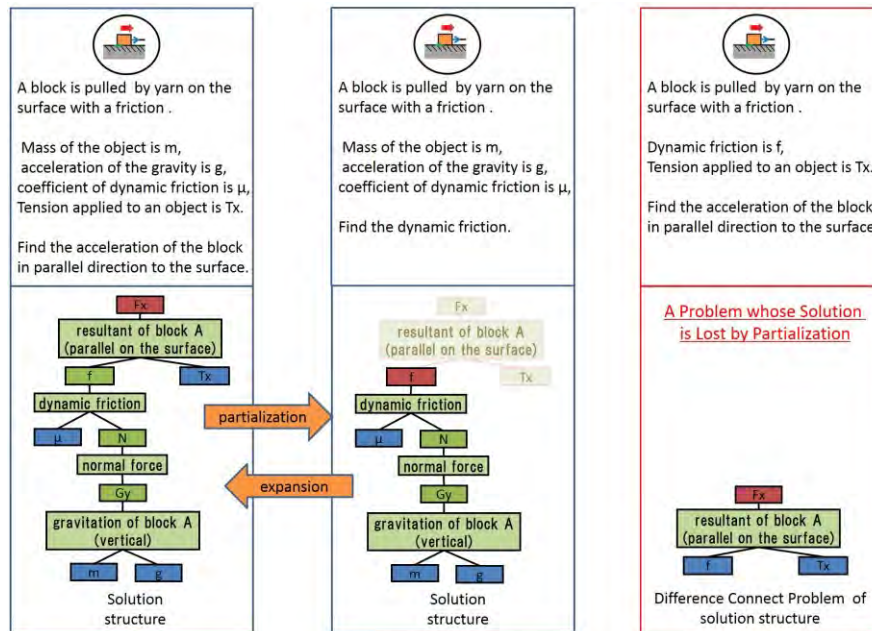

Figure 2. A Difference Connect Problem in Case the Relation between Problem which A Learner could solve and Problem which A Learner couldn't solve is Partialization and Expansion.

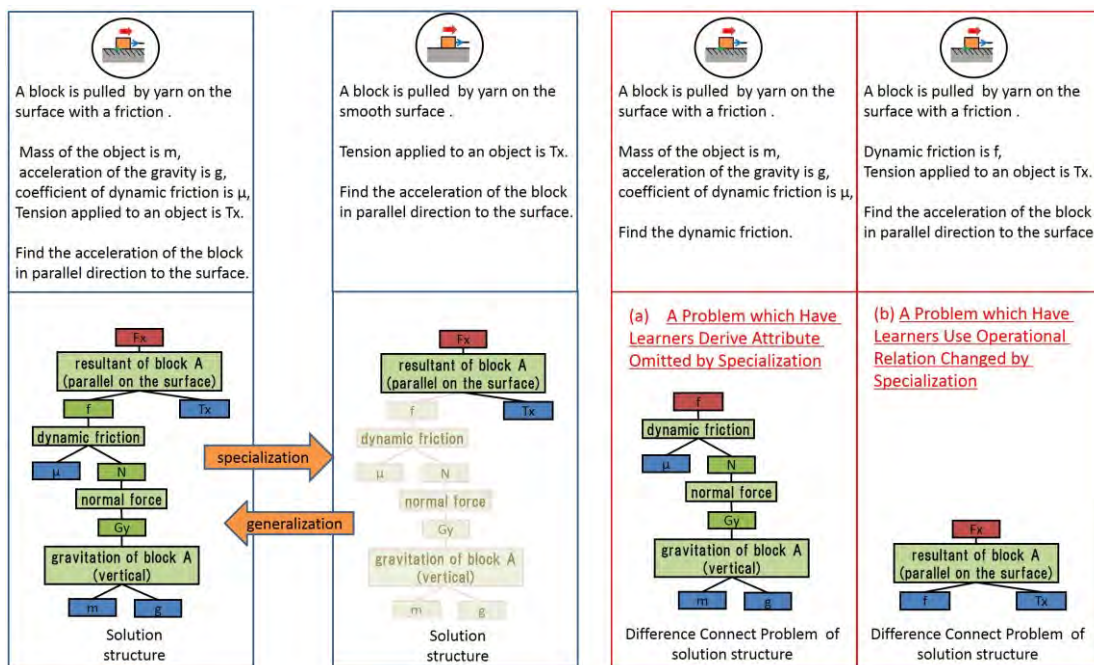

Figure 3. Difference Connect Problems in Case the Relation between Problem which A Learner could solve and Problem which A Learner couldn't solve is Specialization and Generalization.

3.4 Support System for Self-overcoming of Impasse

We had created support system for the self-overcoming of impasse. This system is a system which performs a problem exercise that a natural situation for taking the difference into consideration by “Problem Simplification Strategy”. This system has first problems and can automatically generate simplified problems. This system is implemented on a tablet PC that excels in carrying and been able to use anywhere, taking it into consideration that this system is used at actual schools.

Firstly, learners select a first problem prepared by this system which they should tackle. It is desirable that this problem be a little difficult for the learners. If they cannot solve this problem, they can systematically simplify (specialized/partialized) this problem by only one step based on “Problem

Simplification Strategy”. And so, if they can solve simplified problem, the difference extract function get them to pay attention to a difference between problem which a learner could solve and problem which a learner couldn’t solve. This difference is the origin of the impasse in solving problem and this system specifies this difference. Then, they tackle again the original problem which a learner couldn’t solve and aim to overcome an impasse of solving the problem by only one step. Then, if they cannot solve the original problem once more, this system sets them “a Difference Connect Problem”. If they can solve this problem, they tackle again the original problem. If they cannot solve “the Difference Connect Problem”, they can simplify (specialized/partialized) this problem based on “Problem Simplification Strategy”. Repeating this flow, this system encourages learners to learn with them considering the difference between problems.

On this system,

- (1) If learners cannot solve a certain problem, this problem is simplified.
- (2) After learners can solve simplified problem, through “a Difference Extract Function” or “a Difference Connect Problem”, they tackle the original problem.
- (3) Learners can solve the original problem.

While the above a series of activities, this system only sets learners problems, not teaching how to solve. Furthermore, since learners overcome the problem which they could not solve once, when such activity has been seen, it is assumed that the self-overcoming of impasse has been done.

4. Practical Using Targeting National Collage Students

4.1 A Purpose and Method of Practical Using

We had used the system in class of dynamics at National Collage in a period. This purpose is that we confirm, from a questionnaire and a log, whether “a Problem Simplification Strategy” used by this system is valid support for the self-overcoming of impasse in actual school or not.

The subjects are freshmen of National College of maritime technology. They are 130 people in three classes. A method of practical using is as following;

- (1) operation explanation of a system (10 minutes)
- (2) system exercise (20 minutes)
- (3) post-questionnaire (10 minutes)

The post-questionnaire is shown in Table 1.

We prepare three problems as first problems. These problems are checked by learners’ teacher and are got his assent.

Table 1: The post-questionnaire for learners.

No.	Question
(1)	Do you like mechanics?
(2)	Are you good at mechanics?
(3)	Do you think that this exercise is useful for learning of mechanics?
(4)	Solving the problem which was set after answering correctly, did you use the problem which you could solve as a reference?
(5)	Was the problem that was set after making a mistake easier than the problem you mistake?
(6)	Was solving the problem that was set after making a mistake useful for solving the problem you made a mistake?
(7)	What was especially a good point of this system, you comparing this system with exercise books that you have used in the past?
(8)	Did it make your motivation to tackle the problem exercise increase that you can select the problem to solve next?
(9)	Were you easy to use this system?
(10)	Did using this system make your impression of the mechanics better?
(11)	Do you want to go on such exercises in the future?

4.2 A Result

We used 103 persons' data as valid data, excluding the subjects who cannot be identified from the log and who have a defect in a questionnaire. The result of post-questionnaire is shown in Figure 4. For each item, we treated "I think so very much" and "I think so" as a positive opinion, and "I do not think so" and "I do not think so much" as a negative opinion. We done sign test for each item. This result is that there is no significant difference in question No.10, a significant difference in No.9 ($p < 0.05$), and there are significant difference in the others ($p < 0.01$). In question No.7, there are 33 learners who described contents that they grasp the intent of the exercise. Except the question No.10, questions are positive opinions about this system and are statistically significant. About the question No.10, considering many learners feel reluctant in learning mechanics and this practical using is in only a period, we can interpret this result that about 40 percent of the learners had changed the impression of mechanics by using of this system as not a negative result for this exercise.

Counting the log in valid data, the total number of problems which this system set is 2432. 360 of these are problems which learners could solve, 1899 of these are problems which they couldn't solve, and remaining 173 problems are problems which were not marked because of the time-out and which had a system trouble before marking. And so, there were 53 kinds of problem which the learners had tackled. The average time in which learners tackled a problem was 46.98 seconds ($SD = 82.25$). There are 23.61 problems which a learner had tackled ($SD = 13.09$). We can say that learners can tackle many problems. This is because, we assume, how to tackle one problem depends on learners, e.g. tackling the same problem repeatedly or simplifying problem which they cannot solve. In addition, we assume that the average time in which learners tackled a problem is slightly short because of not taking time so much while resolving a problem which they couldn't solve. Besides, we assume that three first problems prepared by us are the problems of suitable difficulty for learners because they cannot solve all first problems.

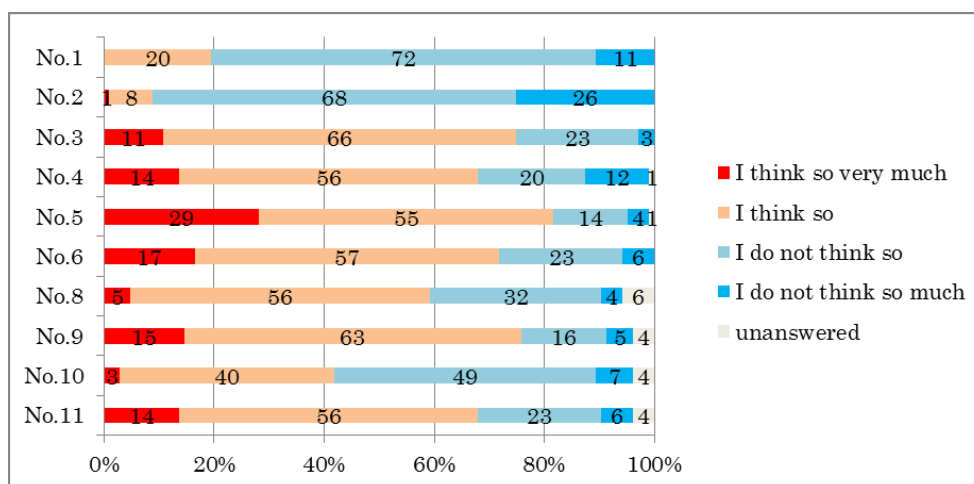

Figure 4. The Result of Post-questionnaire.

4.3 A Learners' Type Classification

We classify a learner's behavior by these features from log data. We call learners who had done the self-overcoming of impasse in "Problem Simplification Strategy" "learners having done the self-overcoming of impasse", learners who had recognized their challenge by finding problem which they can solve "learners having revealed a challenge", and learners who hadn't solved any problems "learners not having solved any problem". Each learner's distribution is shown in Table 2.

There are 29.42 problems which a learner in "learners having done the self-overcoming of impasse" had tackled ($SD = 11.22$). (The breakdown of this is as follows; the average number of problems which he/she could solve is 5.29 ($SD = 2.87$). The average number of problems which he/she couldn't solve is 22.37 ($SD = 9.56$). The rest are problems which were not marked because of the time-out and which had a system trouble before marking.) The average time in which learners tackled a

problem was 38.14 seconds ($SD = 60.52$). There were 6.65 kinds of problem which the learners had tackled ($SD = 2.61$). The ratio of these learners is 60%, and they are learners who had done the self-overcoming of impasse as defined in this research. Because this system only set learners problems in this problem exercise, we assume that their solving problem which they couldn't solve is that they could do the self-overcoming of impasse. Since the 60 % of whole learners could do such activity, we assume that the expected effect of support for the self-overcoming of impasse using "Problem Simplification Strategy" is demonstrated. The number of problems which "learners having done the self-overcoming of impasse" had tackled is also more than one of the other learner groups.

There are 19.86 problems which a learner in "learners having revealed a challenge" had tackled ($SD = 11.03$). (The breakdown of this is as follows; the average number of problems which he/she could solve is 1.60 ($SD = 0.92$). The average number of problems which he/she couldn't solve is 16.34 ($SD = 9.73$). The rest are problems which were not marked because of the time-out and which had a system trouble before marking.) The average time in which learners tackled a problem was 58.45 seconds ($SD = 82.33$). There were 6.34 kinds of problem which the learners had tackled ($SD = 2.66$). The ratio of these learners is a little over 20%. Because these learners couldn't do the self-overcoming of impasse, the average number of problems which they could solve for them is less than one for "learners having done the self-overcoming of impasse". Since "Learners having revealed a challenge" could solve a certain problem, it can be said that they have knowledge required to solve this problem and can use it. Then, it can be said that the difference between problem which they could solve and problem which they couldn't solve is the challenge to be overcome for the learners, and besides, this challenge for the learners have been elicited. We can't suggest that it is effective for the learners to overcome this point by using our system clearly because our system doesn't teach them how to overcome the challenge for them. However, we suggest that the problem exercise using "Problem Simplification Strategy" is useful for these subjects in order to clarify the challenge. Also, we insist that it is important to expand the functions which teach them directly so that they overcome their challenge as necessary.

There are 9.47 problems which a learner in "learners not having solved any problem" had tackled ($SD = 7.24$). (The breakdown of this is as follows; the average number of problems which he/she couldn't solve is 8.31 ($SD = 6.59$). The rest are problems which were not marked because of the time-out and which had a system trouble before marking.) The average time in which learners tackled a problem was 111.43 seconds ($SD = 185.83$). There were 3.36 kinds of problem which the learners had tackled ($SD = 1.49$). The ratio of these learners is a little under 20%. We can consider them as students which don't have the basic knowledge of mechanics. "Problem Simplification Strategy" has the aims of the promotion of understanding the relationship between problems for the student with the knowledge required to solve this problem. "Learners not having solved any problem" must have been taught the knowledge required to solve this problem by classes. However, we can presume that they don't have the knowledge or they cannot use the knowledge for solving problems. Therefore, we can't suggest that it is valid for them to perform this problem exercise. However, we suggest that it is indirectly valid for them to perform this problem exercise because of suggesting that they need a method of learning other than problem exercise. Although outside the scope of this research, it is also important to teach such learners when we consider the overall support of learning of mechanics. Besides, we can consider that we can integrate teaching such learners with our problem exercise with an affinity.

From the above, we confirmed the self-overcoming of impasse through this practical using. However, we still haven't demonstrated a learning effect of this strategy. So, we need to confirm it in the future issue.

Table 2: A Learners' Type Classification.

A learners' type classification.	The number of people	The ratio of the whole
Learners having done the self-overcoming of impasse	61	59.22%
Learners having revealed a challenge	23	22.33%
learners not having solved any problem	19	18.45%

5. Conclusion and Future Issues

In this paper, we suggest “Problem Simplification Strategy” as support for the self-overcoming of impasse. This is a way to aim to do the self-overcoming of impasse by learner’s dividing a problem into the part that can be solved and not solved. We designed and developed support system for the self-overcoming of impasse implemented this strategy. Besides, we had done a practical use of this system in classes of a technical high school. This result shows that this strategy can use as problem exercise and is valid as support for the self-overcoming of impasse because the ratio of “learners having done the self-overcoming of impasse” is 60%. Our main future works are (1) verification of the learning effect of the scaffolding with problem simplification by comparing with the usual problem exercise and (2) design of a fading method of the scaffolding.

References

- Perkinson. (1984). Learning from Our Mistakes: A Reinterpretation of Twentieth-Century Educational Theory. *Praeger*.
- Polya, G. (1945). How to solve it. *Princeton University Press*.
- K. Scheiter, & P. Gerjets. (2002). The Impact of Problem Order: Sequencing Problems as a Strategy for Improving One Performance. *Proc. of the 24th Annual Conference of the Cognitive Science Society*, 798-803.
- K. Scheiter, & P. Gerjets. (2003). Sequence Effects in Solving Knowledge-Rich Problems: The Ambiguous Role of Surface Similarities. *Proc. of 25th Annual Conference of the Cognitive Science Society*, 1035-1040.
- Horiguchi, T., & Hirashima, T. (2005). Graph of Microworlds: A Framework for Assisting Progressive Knowledge Acquisition in Simulation-based Learning Environments. *Proc. of AIED2005*, 670-677.
- Hirashima, T. (2013). Content Analysis and Development of Interactive Learning Environments: In Case of Arithmetic. *Journal of Japanese Society for Information and Systems in Education*, Vol.30, No.1, 8-19.
- Okawachi, Y., Ueno, T., & Hirashima, T. (2012). Development of Automatic Generation Function of Derivative Problems and Its Experimental Evaluation. *Transactions of the Japanese Society for Artificial Intelligence* 27(6) A, 391-400.
- Hirashima, T., Kashihara, A., & Toyoda, J. (1995). A Formulation of Auxiliary Problems and Its Evaluations. *Proc. of 7th World Conference on Artificial Intelligence in Education: AI-ED95*, 186-193.
- Hirashima, T., Niitsu, T., Hirose, K., Kashihara, A., & Toyoda, J. (1994). An Indexing Framework for Adaptive Arrangement of Mechanics Problems for ITS. *IEICE Trans. Inf. & Syst.*, Vol.E77-D, No.1, 19-26.
- Horiguchi, T., & Hirashima, T. (2009). Intelligent Authoring of 'Graph of Microworlds' for Adaptive Learning with Microworlds based on Compositional Modeling. *Proc. of AIED2009*, 207-214.

An Examination of Affect and its Relationship with Learning among Students using SimStudent

Michelle BANAWAN^{1,2}, Maureen VILLAMOR^{1,3}, Yancy Vance PAREDES^{1,2},
Cesar TECSON^{1,4}, Wilfredo BADOY¹, John Roy GERALDE^{1,2}, Ma. Mercedes RODRIGO¹

¹Ateneo de Manila University, Philippines

²Ateneo de Davao University, Davao City, Philippines

³University of Southeastern Philippines, Davao City, Philippines

⁴Cor Jesu College, Digos City, Philippines

mpbanawan@addu.edu.ph, maui.m78@gmail.com, yvmparedes@addu.edu.ph,
catecson@cjc.edu.ph, wbadoy@yahoo.com, jrageralde@addu.edu.ph, mrodrigo@ateneo.edu

Abstract: The goal of this paper was to examine affect-related factors and its relationship with student learning while tutoring an agent called SimStudent. These affect-related factors are the negativity of student self-explanations, the incidence and persistence of student affective states. Secondary school students who were part of this study were asked to teach their SimStudents solve algebra equations and make them pass all the quizzes. Results revealed that students failed to learn which led us to investigate other factors that could have attributed to this failure. Although the non-negatively valenced self-explanations did not have significant relationships with the students' learning gains, the self-explanations were helpful in terms of mathematical content and they generally exhibited positive attitudes when giving the self-explanations. Students also tended to perform better with higher levels of good confusion. Higher levels of boredom were associated with poorer learning. Boredom and confusion were the most persistent but both did not have significant relationships with student learning. Though the negative correlations of the negative self-explanations, incidence and persistence of boredom vis-à-vis learning were not significant, the findings imply that negativity is linked to students' poor performance.

Keywords: Affect, SimStudent, learning by teaching, self-explanation

1. Introduction

SimStudent is an algebra-solving teachable agent that learns problem-solving skills from examples (Matsuda et al., 2011; Carlson, Matsuda, Koedinger & Rose, 2012). A student, who acts as the tutor, gives a problem in a form of mathematical equations with variables which a SimStudent tries to solve one step a time (Matsuda et al., 2012c). Researchers have used SimStudent to investigate learning and the factors that affect learning, e.g. competition (Matsuda et al., 2013), meta-cognitive help (Matsuda et al., 2014), deep vs. shallow learning (Matsuda et al., 2012c), quality of self-explanations (Matsuda et al., 2012a) and others. This paper investigates the relationship between affect and learning among students using SimStudent.

Affect refers to a positive or negative mental state coupled with some combination of physiological arousal, cognitive evaluation, and behavioral expression (Picard, 2000). Affect is interesting because its role is encompassing; be it in decision-making, in perception, in human interaction, or in human intelligence (Picard, 2000). There is an interplay between affect and learning and this claim is supported by recent reports made by affective neuroscience and psychology which suggest that human affect and emotional experience are important as they can influence how humans learn (Ahn & Picard, 2005).

In this paper, we narrate a SimStudent deployment that failed to help students learn. We then examine the relationship between student achievement and the following affect-related factors: *negativity of student self-explanations, incidence of student affective states, and persistence of student affective states.*

2. SimStudent

SimStudent is a teachable agent that helps students learn linear equation problem-solving skills by teaching (Matsuda et al., 2011). It has been tested and redesigned several times, resulting in insights regarding the effects of learning by teaching and related cognitive theories to explain when and how students learn by teaching (Matsuda et al., 2012a; Matsuda et al., 2012b; Matsuda et al., 2013).

SimStudent is a synthetic pedagogical agent that acts as a peer learner. It learns procedural skills from examples. SimStudent attempts to solve a problem given by the student one step at a time. If SimStudent cannot perform a step correctly, it asks the student for a hint. To respond to this request, the student has to demonstrate the step.

This study used the self-explanation version of SimStudent, where the SimStudents ask their tutors to provide explanations for their tutoring decisions, e.g. “*Why should I do this problem?*” or “*But I tried that move earlier. Why doesn’t it work now?*” Students could choose a response from a drop-down list or create freeform responses. SimStudents do not understand these self-explanations. It was included in this version to see the effect of self-explanation for tutor learning.

3. Methods

3.1 Participants

The study took place in one high school in Davao City, Philippines. Two (2) first year high school (Grade 7) sections with an average of 36 students per class were enlisted in this study. All students were taking an algebra class. There were 72 study participants in all with ages ranging from 12 to 14. The average age of the participants was 13.5 years old.

3.2 Structure of the study

The actual experiment was comprised of one session designed for the SimStudent orientation and pre-test, three 60-minute sessions for the actual use of SimStudent in the computer laboratory, and one session for post-test and debriefing.

When students used the software, they tutored their SimStudents in solving equations with variables on both sides. They were informed that their goal was to help their SimStudents pass all four (4) sections of the quiz.

3.3 Measures

There were three types of data collected during the experiment: written test data, system logs, and human observations. Students took pre- and post-test before and after the intervention. Three versions of isomorphic tests, tests A, B, and C, were randomly used to counterbalance the test differences in the pre- and post-tests. The test was divided into five parts. Parts 1, 3, and 5 constituted procedural knowledge while parts 2 and 4 constituted conceptual knowledge. We only used the procedural test scores as the learning outcome measure for the current analysis.

The system automatically logged all of the participants’ activities including problems tutored, feedback provided, steps performed, examples reviewed, hints requested, and quiz attempts.

Finally, human observers noted students’ affect and behavior as they used SimStudent. Observers followed the Baker-Rodrigo Observation Method Protocol (BROMP) 1.0 (Ocumpaugh, Baker & Rodrigo, 2012). The behaviors of interest were *On Task*, *Giving/Receiving Answers*, *Other On Task Conversation*, *Off Task Conversation*, *Off Task Solitary*, *Inactive* and *Gaming* while the affective states were *Boredom*, *Confusion*, *Delight*, *Surprise*, *Flow*, *Frustration*, and *Neutral*.

$$\text{Normalized gain} = \frac{\% \text{Post-test score} - \% \text{Pre-test score}}{1 - \% \text{Pre-test score}} \quad (1)$$

4. Student achievement

Of the 72 participants, only 50 had complete test scores and log data. The analysis that follows is limited to this subset.

As already mentioned earlier, this deployment of SimStudent failed to help students learn. The mean scores of the procedural skill test and their standard deviations are shown in Table 1. The result of the pre-test and the post-test showed that the students did not learn from SimStudent. The average normalized gain was -0.18. Students did not have any classroom instructions between the pre-test and post-test.

Table 1. Mean Test Scores \pm SD for Pre-test and Post-Test

Pre-test (%)	Post-test (%)
37.63 \pm 10.67	35.58 \pm 11.38

With $p=0.42$, the difference between the pre-test and post-test of the students was not statistically significant.

5. Affect-related factors and their relationships with student learning

In this section, we examine several affect-related factors and their relationship with learning. These include the poor quality of student self-explanations, negative attitudes towards SimStudent, and negative affective states.

5.1 Valence of Self-explanations

There is evidence that self-constructed explanations could be an effective way to facilitate learning because the students are able to reflect in the process when they work out the examples themselves based on prior knowledge (Chi, 1996; Matsuda et al., 2012a). Occasionally, SimStudent asked the students what, how, and why questions. Students made their responses by typing their answers or instructions on the given placeholder.

Students' self-explanation responses to SimStudent were classified into 8 categories using a Self-Explanation Coding Manual by Carnegie Mellon University. Eight (8) (N1, N2,..., N8) different codes were used to classify the type of explanation. Table 2 shows the coding scheme along with the summary of the results of the self-explanations.

Table 2. Coding Scheme for Classifying Self-Explanations

Code	Description	Total	%
N1	The input must include a math concept-oriented explanation why the student entered the problem, why SimStudent's performance was wrong, or why the student did a particular demonstration.	53	11.57
N2	The input only provides a math-related explanation of how to solve the problem.	259	56.55
N3	The input blames SimStudent for an incorrect action on the current problem solving process.	10	2.18
N4	The input is related to math but is vague and abstract. It does not include a math-concept-oriented justification for the student's action.	26	5.68
N5	The input is an admission on the part of the student that he/she made a mistake.	1	0.22
N6	The input is an admission on the part of the student that he/she does not know the answer to SimStudent's question.	5	1.09
N7	The input does not address SimStudent's question or the input is just a number.	104	22.71
N8	The input does not fit into the other categories.	0	0

Code	Description	Total	%
	Total	458	100

Two coders independently labeled 651 self-explanations based on the coding scheme. Inter-rater reliability was acceptable with Cohen’s Kappa=0.66. The 651 self-explanations were produced by 50 students who completed the pre-test and post-test. Four hundred fifty-eight (458) self-explanations were retained after discarding the disagreements between coders.

We computed for the percentage of helpful self-explanations per student using the following formula:

$$(N1+N2)/ \text{TotalLabels} \quad (2)$$

Helpful self-explanations are students’ explanations that were found appropriate in terms of mathematical content.

The percentages of helpful self-explanations were correlated with the individual learning gain of the students. We found that there was no correlation between the helpfulness of self-explanations and learning ($r=0.04$; $p=0.94$)

Was there perhaps a link between the emotional valence of the self-explanations and learning? In other words, could students’ positive or negative attitudes towards SimStudent be related to the students’ skills in math? Working independently, two coders labeled the 651 self-explanations for valence. A self-explanation was labeled as negative if it manifested negative emotions like anger, fear, and frustration (e.g. shouting at the tutee by typing in all caps like “*I DON’T KNOW HOW, I’M NOT GOOD IN MATH*”, using exclamatory marks LIKE “*multiply 3!!!*”, not answering, giving irrelevant answers like “*loser*”, and the like). A self-explanation was labeled non-negative if it was polite, patient or neutral (e.g. “*You shall subtract 2 in both sides*”, “*Yes, transfer 6 to the right side*”, “*yes*”, “*no*”). Inter-rater reliability was acceptably high, with Cohen’s Kappa=0.78

After discarding the disagreement between coders, 554 self-explanations labeled for valence remained. Sixteen percent (16%) (89 out of 554) of the total self-explanations had negative valence. On the other hand, eighty-four (84%) (465 out of 554) had positive valence.

The percentages of self-explanations labeled as negative valence were correlated with the learning gains of the students. We found a low negative correlation between negative self-explanations and learning ($r=-0.27$) however the correlation was not significant ($p=0.56$).

5.2 The incidence of boredom and confusion

Is it possible that poor learning gains were related to the incidence and persistence of confusion or boredom? Both confusion and boredom are interesting as previous studies have shown their relationship to learning (Baker, D’Mello, Rodrigo & Graesser, 2010; D’Mello & Graesser, 2012). Confusion has a positive and negative dimension. It has been found that positive or good confusion can motivate learners to exert more effort to learn while negative or bad confusion can cause learners to give up and disengage from a learning task (D’Mello & Graesser, 2012). Boredom has been found to lead to poor learning gains (Rodrigo et al., 2009; Baker, D’Mello, Rodrigo & Graesser, 2010) and non-productive learner behaviors like gaming the system (Baker, D’Mello, Rodrigo & Graesser, 2010).

As mentioned earlier, 72 students participated in this experiment. For every ten of these students, one pair of affect observers used the Baker-Rodrigo Observation Protocol Method (BROMP) to note the affective states of the students. Unfortunately, only one pair of coders had an acceptable inter-rater agreement, with Cohen’s Kappa=0.77. Data from three students was excluded because they had no pre- or post-tests. Hence, for this section, data from only 7 students was included.

With a total of 78 observations, the average for each of the affective state per student was computed to determine the incidence of the affective states. This was further averaged across all seven (7) students and the computed average boredom affect was 13.31% (SD=0.06) while the average confusion affect was 6.57% (SD=0.04).

Learning gains and boredom had a moderate negative correlation ($r=-0.61$) but this relationship was not significant ($p=0.14$). Similarly, learning gains and confusion were moderately correlated ($r=0.54$) but the relationship was not significant ($p=0.21$). Although not statistically significant, the directionality of the correlations was interesting. Students who tend to be confused tend to do better on the post-test, while students who are bored tend to do worse.

The positive correlation of confusion and learning gains implies that students may have experienced a good form of confusion.

5.3 Persistence of boredom and confusion

Finally, we tried to determine whether the persistence of affective states was related at all to learning gains. We computed each affective state's transition likelihood metric L (D'Mello, et al., 2005), which is statistically equivalent to Cohen's Kappa.

L is computed as follows:

$$L = \frac{\Pr(NEXT | PREV) - \Pr(NEXT)}{(1 - \Pr(NEXT))} \quad (4)$$

The L value for each student was computed for a given transition, followed by the mean and the standard error across students. Using the two-tailed test for one sample, we can then determine if a given transition is significantly more likely than chance (chance = 0), given the base frequency of the next state.

Both boredom-boredom and confusion-confusion transitions were not significant (Table 4).

Table 4. L-Values and SD for Confusion and Boredom

Affective State	L-Value	Standard Deviation	p
Boredom	0.11	0.22	0.34
Confusion	0.02	0.14	0.99

The L values of boredom and confusion were correlated with the learning gains of the students. The results showed that there was a moderate negative correlation between boredom and the learning gains however the relationship was not significant ($r=-0.46$, $p=0.28$). The relationship between confusion-confusion and learning gains was practically zero and not significant ($r=-0.01$, $p=0.98$).

6. Summary of Contributions, Limitations, and Future Work

The goal of this paper was to investigate the relationship between student learning gains and affect-related factors. Since student pre-test and post-test scores were not significantly different, we attempted to examine some of the factors that may be related to students' failure to learn. We first examined the quality of students' self-explanations. Majority of the students' self-explanations were helpful in terms of mathematical content. Sixty-nine (69%) of the total self-explanations deliberately instructed SimStudent how to solve the algebra equations. However, the percentages of helpful self-explanations were not significantly correlated with the students' learning gains.

We then examined the valence of the self-explanations. The large majority of self-explanations (84%) were non-negative, i.e. students generally gave helpful, constructive advice. The percentages of negatively valenced self-explanations and learning gains were negatively correlated but the relationship was not significant.

We examined whether certain affective states were related to students' lack of achievement. Although the correlations were not significant, student confusion tended to be correlated with performance while boredom tended to be correlated with poorer learning.

Finally, we examined first whether certain affective states persisted and whether there was a relationship between the student achievement and the persistence of the boredom and confusion. We found that boredom and confusion tended to persist, although the persistence of these affective states was not significant. There were also no significant relationships between persistent boredom and learning gains as well as persistent confusion and learning gains.

Though none of the correlations were significant, the overall trend of the findings imply that negativity goes with poor performance. Negative self-explanations, incidence of boredom, and the persistence of boredom were negatively correlated with the students' learning gains.

For future work, additional, reliable human observations would be very helpful.

Acknowledgements

The authors would like to thank Noboru Matsuda for his research contributions, particularly on SimStudent, that guided us in the completion of this paper.

References

- Ahn, H. & Picard, R. W. (2005). Affective-Cognitive Learning and Decision Making: A Motivational Reward Framework for Affective Agents. *Affective Computing and Intelligent Interaction Lecture Notes in Computer Science*, 3784, 866-87.
- Chi, M. T. (1996). Constructing self-explanations and scaffolded explanations in Tutoring. *Applied Cognitive Psychology*, 10 (Spec Issue), S33-S49.
- D'Mello, S. K., Craig, S. D., Witherspoon, A., McDaniel, B., & Graesser, A. (2005). Integrating Affect Sensor in an Intelligent Tutoring System. *Proceedings of Affective Interactions: The Computer in the Affective Loop Workshop* (pp. 7-13).
- D'Mello, S. K., & Graesser, A. (2012). Dynamics of Affective States During Complex Learning. *Learning and Instruction*, 22 (2), 145-157.
- Matsuda, N., Cohen, W. W., Koedinger, K. R., Keiser, V., Raizada, R., Yarzebinski, E., et al. (2012a). Studying the Effect of Tutor Learning Using a Teachable Agent that asks the Student Tutor for Explanations. In M. Sugimoto, V. Aleven, Y. S. Chee & B. F. Manjon (Eds.), *Proceedings of the International Conference on Digital Game and Intelligent Toy Enhanced Learning (DIGITEL 2012)* (pp. 25-32). Los Alamitos, CA: IEEE Computer Society.
- Matsuda, N., Cohen, W. W., Sewall, J., Lacerda, G., & Koedinger, K. R. (2007). Predicting students performance with SimStudent that learns cognitive skills from observation. In R. Luckin, K. R. Koedinger & J. Greer (Eds.), *Proceedings of the International Conference on Artificial Intelligence Education* (pp. 467-476). Amsterdam, Netherlands: IOS Press.
- Matsuda, N., Griger, C. L., Barbalios, N., Stylianides, G., Cohen, W. W., & Koedinger, K. R. (2014). Investigating the Effect of Meta-Cognitive Scaffolding for Learning by Teaching. In S. Trausen-Matu & K. Boyer (Eds.), *Proceedings of the International Conference on Intelligent Tutoring Systems*: Springer.
- Matsuda, N., Yarzebinski, E., Keiser, V., Raizada, R., Stylianides, G., Cohen, W. W., et al. (2011). Learning by Teaching SimStudent – An Initial Classroom Baseline Study comparing with Cognitive Tutor. In G. Biswas & S. Bull (Eds.), *Proceedings of the International Conference on Artificial Intelligence in Education* (pp. 213-221): Springer.
- Matsuda, N., Yarzebinski, E., Keiser, V., Raizada, R., Stylianides, G., & Koedinger, K. R. (2013). Studying the Effect of Competitive Game Show in a Learning by Teaching Environment. *International Journal of Artificial Intelligence in Education*, 23 (1-4), 1-21.
- Matsuda, N., Yarzebinski, E., Keiser, V., Raizada, R., William, W. C., Stylianides, G., et al. (2013). Cognitive anatomy of tutor learning: Lessons learned with SimStudent. *Journal of Educational Psychology*, 105(4), 1152-1163.
- Ocuppaugh, J., Baker, R. S.J.d., & Rodrigo, M. M. T. (2012). Baker-Rodrigo Observation Method (BROMP) 1.0 Training Manual version 1.0.
- Picard, R. W. (2000). *Affective Computing*. MIT Press.

An Exploratory Analysis of Confusion Among Students Using Newton's Playground

Juan Miguel L. ANDRES^{a*}, Ma. Mercedes T. RODRIGO^a, Jessica O. SUGAY^a,
Ryan S. BAKER^b, Luc PAQUETTE^b,
Valerie J. SHUTE^c, Matthew VENTURA^c, & Matthew SMALL^c

^a*Ateneo de Manila University, Philippines*

^b*Columbia University, USA*

^c*Florida State University, USA*

miglimjapandres@gmail.com, mrodrigo@ateneo.edu, jsugay@ateneo.edu

baker2@exchange.tc.columbia.edu, luc.paquette@gmail.com

vshute@fsu.edu, mventura@fsu.edu, matthewsmall@gmail.com

Abstract: We investigated the interplay between confusion and in-game behavior among students using Newton's Playground (NP), a computer game for physics. We gathered data from 48 public high school students in the Philippines. Upon analyzing quantitative field observations and interaction logs generated by NP, we found that confusion among students was negatively correlated with earning a gold badge (solving a problem with objects under par), positively correlated with earning a silver badge (solving a problem with objects over par), and positively correlated with stacking (drawing numerous small objects to reach the objective), a form of gaming the system.

Keywords: Confusion, student affect, Newton's Playground, learning, in-game behavior

1. Introduction

In recent years, researchers have been investigating the state of confusion among learners using intelligent tutoring systems. Confusion, or cognitive disequilibrium, is defined as the uncertainty about what to do next (D'Mello et al., 2005). It occurs when a student encounters stimuli or experiences that fail to meet expectation (D'Mello, Lehman, Pekrun, & Graesser, 2014) and plays an important role in the learning process because cognitive disequilibrium "has a high likelihood of activating conscious, effortful cognitive deliberation, questions and inquiry that aim to restore cognitive equilibrium (Craig, Graesser, Sullins, & Gholson, 2004; D'Mello et al., 2008)." Confusion is actually useful when it spurs learners to exert effort deliberately and purposefully to resolve cognitive conflict. If the learners are successful, they return to a state of flow – complete immersion and focus upon the system (Csikszentmihalyi, 1990). However, confusion may also be negative. If unresolved, confusion can lead to frustration or boredom, and students may decide to disengage from the learning task altogether (D'Mello & Graesser, 2012). Previous studies have shown confusion to correlate positively with learning gains (Craig et al., 2004; D'Mello et al., 2014). Extended periods of confusion, however, were associated with negative learning outcomes (Lee, Rodrigo, Baker, Sugay, Coronel, 2011).

This study explores student in-game events that may be indicative of student confusion within Newton's Playground (NP, described in detail in Section 2), a computer game for physics. NP requires the player to guide a green ball to a red balloon by drawing simple machines on the screen with colored markers controlled by the mouse. The software has been used previously for stealth assessment of creativity, persistence, and conceptual physics understanding (Shute & Ventura, 2013). The studies found significant improvement in terms of conceptual physics understanding among students that played the game, depending on how engaged they were (or how many levels they attempted to play) during gameplay (see Shute, Ventura, & Kim, 2013). Additional studies are using Newton's Playground to examine the relationship between student affect, in-game behavior, and

mastery of physics concepts. This exploratory study examines human observations alongside logged student-software interactions to determine what in-game events correlate with student confusion.

2. Study population, system, and data collection methodology

2.1 Participant Profile

We conducted a study to measure the relationship between a variety of affective and cognitive variables. Data was gathered from 60 eighth grade public school students in Quezon City, Philippines. Students ranged in age from 13 to 16. As of 2011, the school had 1,976 students, predominantly Filipino, and 66 teachers. Of the participants, 31% were male and 69% were female. Participants were asked to rate how frequently they played video games and watched television on a scale of 1 (not at all) to 7 (everyday, for more than 3 hours), and the resulting average frequency of gameplay is 3.2 (in between a few times a month, and a few times a week), and the resulting average frequency of watching television is 5.9 (in between everyday, but for less than 1 hour, and everyday, for 1-3 hours). Participants were asked for their most frequent grade on assignments, and on a scale of 0 (F) to 4 (A), the average most frequent grade of the participants is 3.1 (B).

2.2 The Software

Newton's Playground (NP) is a computer game for physics patterned after Crayon Physics Deluxe. It was designed to help secondary school students understand qualitative physics (Shute & Ventura, 2013). Qualitative physics is a nonverbal conceptual understanding of how the physical world operates, along the lines of Newtonian physics. Qualitative physics is characterized by an implicit understanding of Newton's three laws: balance, mass, and conservation and transfer of momentum, gravity, and potential and kinetic energy (Shute et al., 2013).

NP is a two-dimensional computer-based game that requires the player to guide a green ball to a red balloon. Two example levels are shown in Figure 1, the level on the left requiring a pendulum, and the level on the right requiring a lever. The player uses the mouse to nudge the ball to the left and right (if the surface is flat), but the primary way to move the ball is by drawing or creating simple machines on the screen with the mouse and colored markers. The objects come to life once the object is drawn. Everything obeys the basic rules of physics relating to gravity and Newton's three laws of motion (Shute et al., 2013).

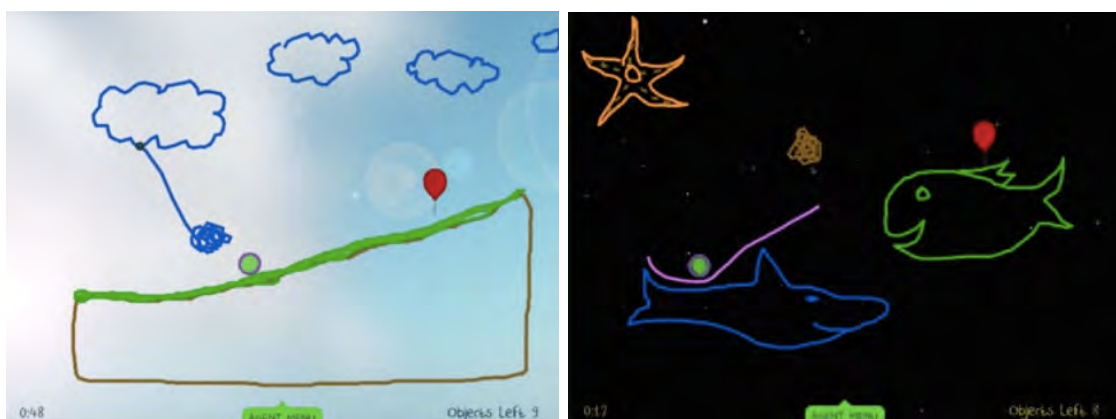

Figure 1. Examples of Newton's Playground levels.

The 74 levels in NP require the player to solve the problems via drawing different simple machines, representing agents of force and motion: inclined plane/ramps, levers, pendulums, and springboards. Again, all solutions are drawn with colored markers using the mouse. A ramp is any line drawn that helps to guide a ball in motion. A ramp is useful when a ball must travel over a hole. A lever rotates around a fixed point, usually called a fulcrum or pivot point. Levers are useful when a player wants to move the ball vertically. A swinging pendulum directs an impulse tangent to its

direction of motion. The pendulum is useful when the player wants to exert a horizontal force. A springboard (or diving board) stores elastic potential energy provided by a falling weight. Springboards are useful when the player wants to move the ball vertically.

Gold badges versus silver badges. Some levels in NP have multiple solutions, which means a player can solve the level using different agents. Gold badges are awarded when a player solves a problem “under par;” that is, under a limit set for a specific solution. For example, a level may be solved using a ramp, with a par of 1 object, or a lever, with a par of 3 objects. If a player solves the level with more objects than par, he receives a silver badge. Gold badges suggest that the player has mastered the agent relevant to the given level. Silver means the player may not have fully mastered the agent yet.

Stacking. During pilot testing, Shute et al. (2013) reported that it was possible to game the system to succeed without using the target knowledge (Baker, Corbett, Koedinger, & Roll, 2006) by drawing many tiny objects that stack up, propelling the ball upward until it reaches the target. This behavior is called stacking. The log files capture stacking actions on levels where the player did this (Shute et al., 2013).

2.3 *The Interaction Logs*

We collected two types of data during the study: interaction logs and human observations. During gameplay, NP automatically generates log files. Each level a student plays creates a corresponding log file, which tracks every interaction the student has with the game in terms of particular counts and times for selected features of gameplay. These features include but are not limited to:

- Time spent on the level in seconds,
- Number of in-level restarts,
- Number of objects drawn in a solution attempt,
- Whether the level was ultimately solved,
- Whether or not the player earned a gold or silver badge, and
- Whether or not a player was stacking, a form of gaming the system – the systematic misuse of system features to advance through the learning materials without learning the content (Baker et al., 2006) – within Newton’s Playground

Each of these variables provides useful information about students’ gameplay behaviors, which can then be used to make inferences about how well they are doing in the game (Shute et al., 2013).

2.4 *The Observation Protocol*

The Baker-Rodrigo-Ocupaugh Monitoring Protocol (BROMP) is a protocol for quantitative field observations of student affect and behavior. BROMP is a holistic coding procedure that has been used in thousands of hours of field observations of students, from kindergarten to undergraduate populations. It has been used for several purposes, including to study the engagement of students participating in a range of classroom activities (both activities involving technology and more traditional classroom activities) and to obtain data for use in developing automated models of student engagement with Educational Data Mining (EDM) (Ocupaugh, Baker, & Rodrigo, 2012). Within BROMP, each student observation lasts 20 seconds, and the observers move from one student to the next in a round robin manner during the observation period.

The affective states observed within Newton’s Playground were concentration, confusion, frustration, boredom, happiness, delight, and curiosity. The behaviors observed were on-task, off-task, stacking, and a behavior called *without thinking fastidiously* (WTF), a behavior in which, despite a student’s interaction with the software, “their actions appear to have no relationship to the intended learning task (Wixon, Baker, Gobert, Ocupaugh, & Bachmann, 2013).” The analysis of the behaviors, however, is outside this paper’s scope.

The inter-coder reliability for affect was acceptably high with a Cohen’s (1960) Kappa of 0.67. The typical threshold for certifying a coder in the use of BROMP is 0.6, established across dozens of studies as well as the previous affective computing literature.

2.5 Procedure

Before playing Newton's Playground, students completed a 16-item multiple-choice pretest for 20 minutes. Students were then assigned a computer on which they would play NP. Students played the game for two hours, during which, two trained observers used BROMP to code student affect and behavior. A total of 36 observations per participant per observer were collected. Videos of participants' faces were also recorded during gameplay. After completing the two hours of gameplay, participants completed a 16-point multiple-choice posttest for 20 minutes. The pretest and posttest were designed to assess knowledge of physics concepts, and has been used in previous studies involving Newton's Playground (Shute et al., 2013).

The pretest and posttest scores were tabulated and averaged. Students scored an average of 6.02 out of 16 in the pretest, and 6.02 out of 16 in the posttest. While these results suggest that NP did not seem to help increase knowledge of physics concepts, the researchers noticed that students were answering the posttest hurriedly. The posttest scores may thus not reflect an accurate knowledge assessment. It is important to note, however, that significant pretest-to-posttest improvements were reported in three previous studies that also used NP. Students in these studies used NP for longer periods of time.

3. The Relationship between Student Confusion and In-game Events

In order to investigate how students mastered content in Newton's Playground, we made use of the interaction logs recorded during gameplay to analyze student performance. Of the 60 participants, data from 12 students were lost because of faulty data capture and corrupted log files. Only 48 students had complete observations and logs. The analysis that follows is limited to these students.

The BROMP observations were tabulated, and the percentage of each affective state per student was calculated. Boredom, confusion, and frustration were three of the more commonly observed affective states, besides concentration.

All interaction logs were passed through a parser to arrange log events in tab-delimited text files. These text files were then run through a filter to get per student, per level, per attempt summaries, such as total time spent, total number of restarts, total number of objects drawn, etc. Finally, the information was collapsed to form per student vectors that summarized the students' entire interactions with the game. Each vector included the following attributes, which are indicative of mastery:

- Gold badge – percentage of level attempts solved, earning the student a gold badge
- Silver badge – percentage of level attempts solved, earning the student a silver badge
- Stacking – percentage of level attempts wherein a student was flagged for stacking

These three attributes, among about thirty other gameplay features, were correlated with the percentage of confusion, based on the human observations. Because the number of tests introduces the possibility of false discoveries, Storey's adjustment was used as a post-hoc control. Storey's translates the p-value to a q-value, which represents the probability that the finding was a false discovery. Among the results, earning a silver badge was positively correlated with confusion, while earning a gold badge was negatively correlated, and stacking was positively correlated with confusion. Table 1 shows their correlations, p-values, and q-values. Note that the findings were still significant even after the post-hoc correction was applied.

Table 1: Correlations between student interaction and confusion, their p-values, and q-values.

	Silver badges	Gold badges	Stacking
Correlation	0.32	-0.29	0.31
p-value	0.03	0.04	0.03
q-value	0.02	0.03	0.03

The opposite relationship between gold and silver badges and confusion is interesting. Recall that solving a level under par earns a player a gold badge, while solving a level with more objects than par, no matter how many are drawn, earns the student a silver badge. As mentioned earlier, earning a

gold badge is indicative of mastery of the four agents being used in the game. Mastery of these agents goes beyond knowing what agents to use, as in many cases, different agents can be used to solve the same level. Mastery also entails proper execution of the drawing, and being able to keep the number of objects under par. A player has to be very precise in his understanding of various aspects of the agents (e.g. how massive an object must be and from what height it must be dropped onto a springboard in order to propel the ball towards the target) Students who have mastered the agents do not have to experiment for prolonged periods of time with drawing different objects to see which agents will propel the ball closer to the balloon.

If a student has not yet mastered the agents, however, he may end up making more guesses, experimenting by drawing different objects until the ball reaches the balloon, and ends up earning a silver badge. Understanding the solution could help the student gain mastery of the agents, but finding a solution merely by chance may contribute to making him even more confused.

The other interesting observation was the positive correlation between confusion and stacking, which, as mentioned earlier, is a form of gaming the system within NP, a behavior associated with negative affect. Previous studies have found confusion to have no significant effect on gaming the system (Baker, D’Mello, Rodrigo, & Graesser, 2010). This correlation, however, suggests that the more confused a student is, the more likely he is to stack. Stacking indicates a lack of mastery of the physics agents.

4. Conclusions and Future Work

In this study, we attempted to identify in-game events that may relate to confusion among students playing Newton’s Playground. Students played NP for two hours while two BROMP coders labeled student affect and behavior. These observations were then analyzed alongside NP interaction logs. In our analysis, we found that confusion was negatively correlated with earning a gold badge but positively correlated with earning a silver badge, and that stacking and confusion are positively correlated. This implies that, within our population, students who are confused lack of mastery of physics concepts. They solve problems inefficiently, using more objects than necessary. On the other hand, students who develop mastery of physics concepts are able to solve the NP problems with an optimal number of objects.

This study is the first of many analyses done on the data set, and is part of a bigger investigation. As such, there are several next steps to take from this work. One avenue is to disambiguate good and bad confusion, and find what student behaviors are indicative of each. Learning benefits can be derived from episodes of good confusion (D’Mello & Graesser, 2011). Bad confusion, on the other hand, has no pedagogical value (D’Mello & Graesser, 2011).

It would also be interesting to explore how student boredom manifests itself within NP. Boredom is defined as an “unpleasant, transient affective state in which the individual feels a pervasive lack of interest in and difficulty concentrating on the current activity” (Fisher, 1993). Boredom has been associated with poorer learning (e.g. Craig et al., 2004) and problem behaviors, such as gaming the system (e.g. Baker et al., 2010).

Acknowledgements

We would like to thank the Ateneo Center for Educational Development, Carmela C. Oracion, Christopher Ryan Adalem, the officials at Krus Na Ligas High School, and the Gates Foundation Grant #OP106038 for making this study possible.

References

- Baker, R.S.J.d., Corbett, A.T., Koedinger, K.R., Roll, I. (2006) Generalizing Detection of Gaming the System Across a Tutoring Curriculum. Proceedings of the 8th International Conference on Intelligent Tutoring Systems, 402-411.
- Baker, R. S., D’Mello, S. K., Rodrigo, M. M. T., & Graesser, A. C. (2010). Better to be frustrated than bored: The incidence, persistence, and impact of learners’ cognitive–affective states during interactions with three

- different computer-based learning environments. *International Journal of Human-Computer Studies*, 68(4), 223-241.
- Cohen, J. (1960). A Coefficient of Agreement for Nominal Scales. *Educational and Psychological Measurement*, 20 (1960), 37-46.
- Craig, S., Graesser, A., Sullins, J., & Gholson, B. (2004). Affect and learning: an exploratory look into the role of affect in learning with AutoTutor. *Journal of Educational Media*, 29(3), 241-250.
- Csikszentmihalyi, M. (1990). *Flow: The psychology of optimal experience*. New York: Harper Perennial.
- D'Mello, S., Craig, S. D., Gholson, B., Franklin, S., Picard, R., & Graesser, A. C. (2005). Integrating affect sensors in an intelligent tutoring system. In *Affective Interactions: The Computer in the Affective Loop Workshop* at (pp. 7-13).
- D'Mello, S., & Graesser, A. (2011). The half-life of cognitive-affective states during complex learning. *Cognition & Emotion*, 25(7), 1299-1308.
- D'Mello, S., Graesser, A. (2012). Dynamics of affective states during complex learning. *Learning and Instruction*, 22(2): 145-157.
- D'Mello, S., Jackson, T., Craig, S., Morgan, B., Chipman, P., White, H., ... & Graesser, A. (2008). AutoTutor detects and responds to learners affective and cognitive states. In *Proceedings of the Workshop on Emotional and Cognitive issues in ITS in conjunction with the 9th International Conference on Intelligent Tutoring Systems* (pp. 31-43).
- D'Mello, S., Lehman, B., Pekrun, R., & Graesser, A. (2014). Confusion can be beneficial for learning. *Learning and Instruction*, 29, 153-170.
- Fisher, C. D. (1993). Boredom at work: A neglected concept. *Human Relations*, 46(3), 395-417.
- Lee, D.M., Rodrigo, M.M., Baker, R.S.J.d., Sugay, J., Coronel, A. (2011) Exploring the Relationship Between Novice Programmer Confusion and Achievement. *Proceedings of the 4th bi-annual International Conference on Affective Computing and Intelligent Interaction*.
- Ocuppaugh, J., Baker, R.S.J.d., Rodrigo, M.M.T. (2012) Baker-Rodrigo Observation Method Protocol (BROMP) 1.0. Training Manual version 1.0. Technical Report. New York, NY: EdLab. Manila, Philippines: Ateneo Laboratory for the Learning Sciences.
- Shute, V. J., Ventura, M., & Kim, Y. J. (2013). Assessment and Learning of Qualitative Physics in Newton's Playground. *The Journal of Educational Research*, 106(6), 423-430.
- Shute, V., & Ventura, M. (2013). *Stealth assessment: Measuring and supporting learning in video games*. MIT Press.
- Wixon, M., Baker, R. S., Gobert, J. D., Ocuppaugh, J., & Bachmann, M. (2012). WTF? detecting students who are conducting inquiry without thinking fastidiously. In *User Modeling, Adaptation, and Personalization* (pp. 286-296). Springer Berlin Heidelberg.

Evaluation of Difficulty Estimation for Learning Materials Recommendation

Yasuo MIYOSHI ^{a*}, Kazuhiro SUZUKI ^a, Ken-ichi SHIOTA ^a & Ryo OKAMOTO ^a

^aFaculty of Science, Kochi University, Japan

*miyoshi@is.kochi-u.ac.jp

Abstract: The popular technology for the information recommendation of books or web pages is based on taste information from many users, but it is important to be based on difficulty and proficiency for the recommendation of learning materials. We have developed an algorithm to estimate difficulty of learning materials and proficiency of learners, for recommendation considering difficulty of learning materials. The algorithm uses only a bipartite learner-material graph that consists of the reader relations with materials and learners. In this paper, we describe how to make an accurate data to evaluate the estimated difficulty, and report about the result that evaluated the precision of our proposed algorithm.

Keywords: Personalized recommendation, learning materials, difficulty estimation

1. Introduction

Most of mainstream information recommendation systems use content-based filtering or collaborative filtering based on the past behaviors of users, and may use hybrid filtering that redeems their defects and capitalizes on their respective strengths. Both the filters are based on taste information from many users. In recommendation for learning materials, the recommender systems that based on taste information of users might recommend the materials too difficult to a user. They might recommend the materials too easy adversely. The recommender system for learning materials desires to recommend the materials that have suitable difficulty for users. Therefore we propose new filtering based on difficulty of learning materials and proficiency of users. As you can see in figure 1, we propose also a recommender system that adopts pipelined hybrid filtering. Our proposed system recommends the learning materials suitable for proficiency of users after having narrowed down candidate materials by users' taste information.

2. Related Work

Durand, Belacel and LaPlante (2013) proposed a learning path recommendation algorithm using graph theory based model. This approach focuses on ways to search for potential learning paths. We suggest that a new and good learning material would be hard to be recommended by affected by old learning paths. Ghauth and Abdullar (2010) and Guo, Erdt and Lee (2013) proposed a learning materials recommendation algorithm based on difficulty of materials. Their recommender systems ask to learners to specify a difficulty level. Among other examples, there is a difficulty based recommender system for recommending games on mobile phones (Skocir et al., 2012).

3. Algorithm to Estimate Difficulty and Proficiency

3.1 Summary of Estimation Algorithm

Our algorithm does not use contents of learning materials at all. It only use the reading relations that denote who read which materials. The reading relations are expressed in bipartite graph like figure 2, and we call it a learner-material graph. Even if learning materials may be acquired no contents, this algorithm can make it a target of recommendation by combining with collaborative filtering like figure 1 because it can estimate difficulty and proficiency without using the contents of the learning

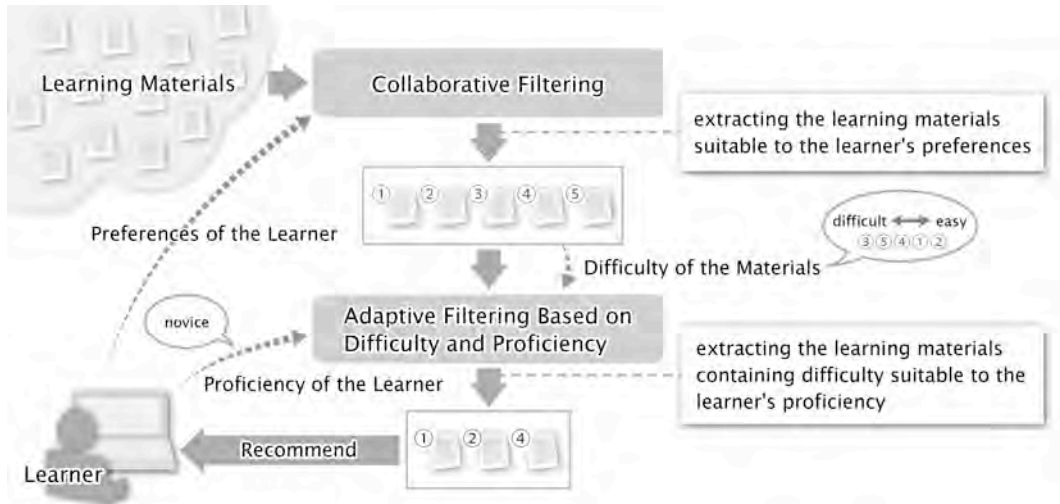

Figure 1. A Proposed Recommender System that Adopts Pipelined Hybrid Filtering.

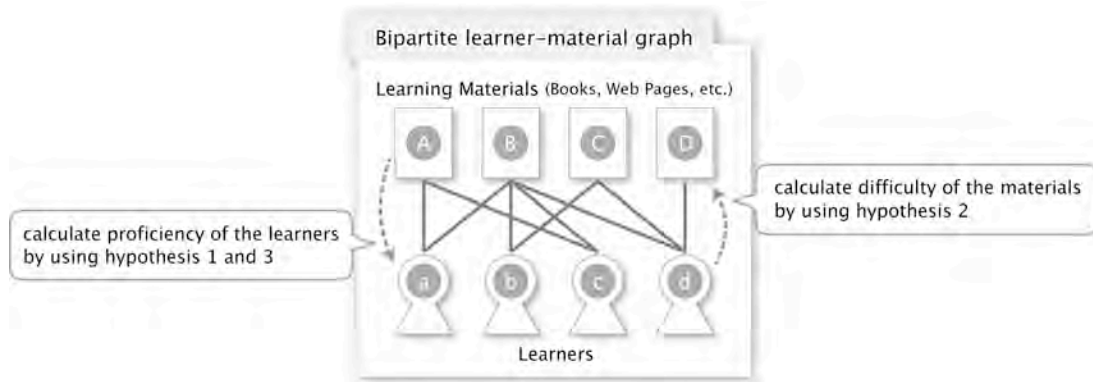

Figure 2. To Estimate Difficulty and Proficiency Using Learner-Material Graph.

materials. One of feature of this algorithm is to be able to simultaneously estimate difficulty of learning materials and proficiency of learners, but the estimation algorithms based on contents can estimate only difficulty. In addition, this algorithm is similar to PageRank (Page, Brin, Motwani and Winograd, 1999) and HITS (Kleinberg, 1999) that are popular webpage ranking algorithms, in concept to use a link structure of the graph network. The elemental algorithm performs based on the following hypotheses.

- Hypothesis 1: A learner reading a lot of learning materials of a domain should know a lot about the domain.
- Hypothesis 2: A learning material read by learners that have much knowledge should be difficult, and a material read by learners that do not know a lot should be easy.
- Hypothesis 3: A learner reading difficult learning materials should know a lot, and a learner reading easy materials should not have much knowledge.

At first, proficiency of learners is estimated by hypothesis 1. Next, based on hypothesis 2, difficulty of learning materials is calculated from proficiency of the learners. Then proficiency is recalculated from difficulty of the materials by hypothesis 3. Hypothesis 2 and 3 are influenced by each other. The calculations based on hypothesis 2 and 3 are repeated until the calculation result converges.

Hypothesis 1 and 3 are expressed as:

$$p_u = \sum_{i \in I_u} \dot{d}_i \quad (1)$$

where p_u is proficiency of the learner u and \dot{d}_i is normalized difficulty of the learning material i and I_u is a set of learning materials read by the learner u . The initial value of \dot{d}_i is 0.5. The difficulty value d_i of hypothesis 2 is written as:

$$d_i = \sum_{u \in U_i} (\dot{p}_u - 0.5) \quad (2)$$

where \dot{p}_u is normalized proficiency of the learner u and U_i is a set of learners who read the material i . The normalization values of \dot{d}_i and \dot{p}_u are found by dividing the deviation value by 100.

3.2 Improve of the Algorithm

We will define difficulty of learning materials and proficiency of learners before we describe an improved algorithm. The premise to estimate difficulty of learning materials and proficiency of learners is for recommending the learning materials. Therefore, in this study, we define the term “difficulty of a learning material” as presupposed knowledge quantity necessary to get most knowledge with the learning material, and define the term “proficiency of a user” as knowledge quantity that the user has about the domain of the learning materials and the associated domain.

The obtained values of difficulty and proficiency from elemental algorithm are relativity, and then there are not the direct relations in each other's values. Therefore the values are hard to be handled to recommend learning materials, because the value of difficulty of the learning material suitable for a learner who has a proficiency value is unclear. In addition, the elemental algorithm does not consider the order of that a learner read learning materials. The algorithm improved from elemental algorithm considers the order and estimates how learners acquire knowledge, for improvement of precision. Specifically we add hypothesis 4 and revise hypothesis 2 and 3 because a learner that has much knowledge might read an easy material.

- Hypothesis 4: A learning material read by expert learners while they are beginners should be easy.
- Hypothesis 2': A learning material read by learners that have much knowledge should be difficult.
- Hypothesis 3': A learner reading difficult learning materials should know a lot.

Furthermore, the improved algorithm makes it clear that the difficulty value of the learning material suitable for a learner is near to the proficiency value of the learner because the improved algorithm uses a same unit of the values of difficulty and proficiency by changing methods of calculation and normalization. Figure 3 and 4 show the difference of the estimation methods between

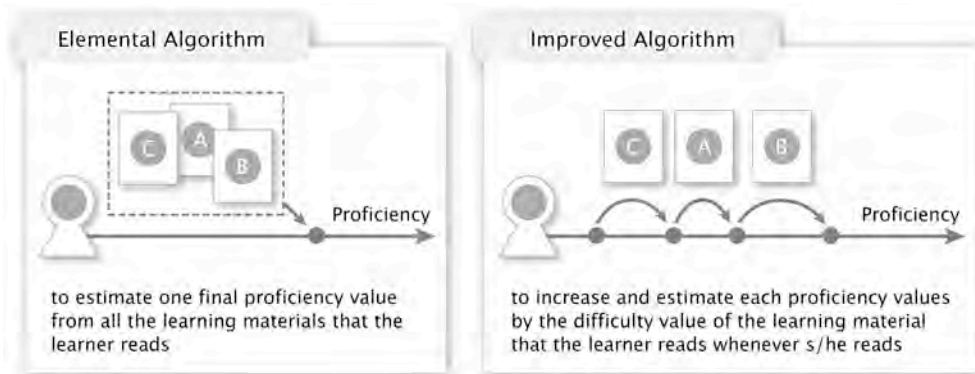

Figure 3. The Difference of the Methods for Proficiency Estimation.

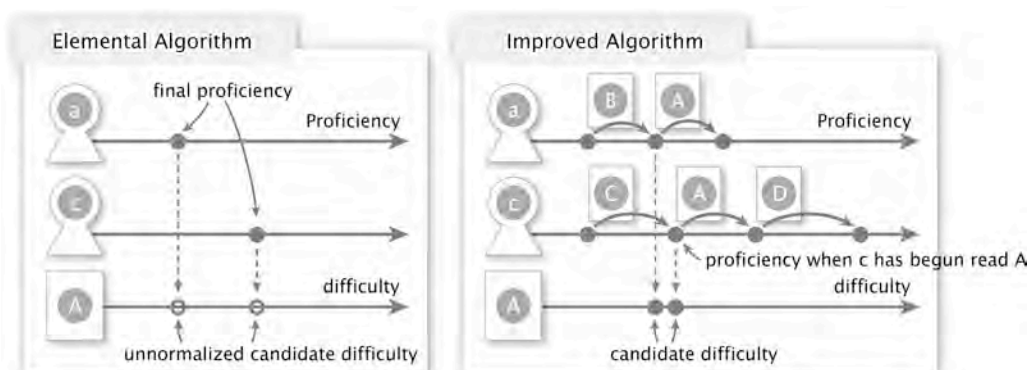

Figure 4. The Difference of the Methods for Difficulty Estimation.

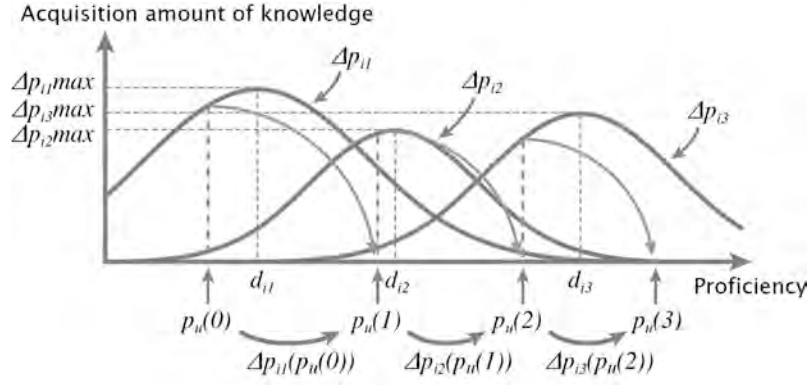

Figure 5. The Amount of Knowledge Acquired by Learner u

elemental algorithm and improved algorithm. The improved algorithm estimates the amount of knowledge acquired by the learner that reads a learning material. We describe the flows of estimation of the amount of acquisition knowledge by using figure 5. Learner u acquires knowledge from initial proficiency $p_u(0)$ to $p_u(3)$, when the learner reads in order of learning material $i1$, $i2$, $i3$. $p_u(n)$ is the proficiency value of learner u after having read the n -th learning material. Δp_i as the amount of knowledge acquired by reading learning material i depends on p_u at that time:

$$\Delta p_i = \Delta p_i \max \cdot \sigma_i^{-(p_u - d_i) / \Delta p_i \max} \quad (3)$$

where $\Delta p_i \max$ is the height of the curve and σ_i is the width of the curve. For example, quantity of knowledge $\Delta p_{i1}(p_u(0))$ is slightly lower than $\Delta p_i \max$ because $p_u(0)$ is lower than d_{i1} , and then $p_u(1)$ is given by $p_u(1) = p_u(0) + \Delta d_{p1}(p_u(0))$. The initial value of proficiency $p_u(0)$ is tentatively the difficulty value of the learning material that is read by u at the beginning in this study. However, $p_u(0)$ is the difficulty value of the next learning material if the next material is easy than first material. Therefore, although $p_u(0)$ is lower than d_{i1} in figure 5, $p_u(0)$ is d_{i1} accurately. Maximum quantity of acquirable knowledge $\Delta p_i \max$ and a spread of target scope σ_i are tentatively unity values, although the calculation methods of them are under consideration. As you can see in figure 4, a learning material gets some candidate difficulty values from the learners who read it. Most learners should have proficiency higher than or comparable with the difficulty value d_i , because d_i means quantity of knowledge necessary to read learning material i . Therefore, in this study, d_i is tentatively the middle value with the minimum and the median of the proficiency values of each learners.

4. Evaluation of Difficulty Estimation

We evaluated precision improvement between the elemental algorithm and the improved algorithm. The evaluation of estimation precision is relative evaluation. We compared the order of values estimated by the algorithm with the order of accurate data. We gathered and created the learner-material graph that represents the relations between web pages written about programming language C and the users that bookmarked them from social bookmark site ‘‘Hatena Bookmark’’ (<http://b.hatena.ne.jp/>) that is famous in Japan. The learners of the graph are the bookmark users, and the learning materials of the graph are the bookmarked web pages. Although our proposed algorithm is able to estimate not only difficulty of learning materials but also proficiency of learners, we evaluated only difficulty estimation because it is impossible to appreciate accurate proficiency of the bookmark site users. We would like to evaluate the learner proficiency estimation of our algorithm by letting the subject, whose accurate proficiency is known, use the bookmark site in the long term.

4.1 Accurate Difficulty Values of Learning Materials for Comparing with Estimated Data

We extracted the partial graph from the learner-material graph at random because to get accurate values of difficulty of all-bookmarked pages increases in cost. A scale of the learner-material network

is 6,079 learners, 16,016 materials and 40,145 bookmarks. Their bookmarks have “C language” tag. We have decided the target page count of getting accurate value as 30 in consideration of workload of the subjects. We randomly selected 50 pages from the web pages that were bookmarked by over 30 users, because the pages may include inappropriate contents and have broken links. There were no pages including inappropriate contents, but 9 pages were not found or not available. Then we randomly reselected 30 pages from the 41 pages. All extracted web pages are technical contents about C programming and consist of blogs, news articles, reference pages, curated pages and so on.

We calculated accurate difficulty values from the results of the experiment evaluated by subjects that are learning C language. The subjects are 42 undergraduate students that learn information science, university freshmen are 13 people, second year students are 14 people and third year students are 15 people. The experiment was carried out in December 2013, and freshmen did not yet study a class of the C language at that point in time. Therefore we assume that the subjects consist of beginners and intermediate graders. The subjects firstly glanced through a web page for around 10 seconds and then evaluated in 5-point scale how much knew the contents of the page by oneself (Q1). The subjects secondly read the page and then evaluated in 4-point scale whether it was a useful page for oneself (Q2). The scales of Q1 are “not to know at all (0%)”, “know a little (25%)”, “know half (50%)”, “know most (75%)” and “know at all (100%)”. The scales of Q2 are “1) almost useless”, “2) useless a little”, “3) helpful a little”, “4) very helpful”. We confirmed that the self-evaluation of understanding became low as the young year students and the tendency of the frequency distribution of Q1 and Q2 became different, by analyzing the answers of all subjects for 30 pages. Therefore we calculated accurate difficulty values of learning materials from the answer data, using Item Response Theory (IRT). We used 1 parameter logistic model because we need only simple indicator of difficulty. The binary response data represents whether a subject is able to understand a learning material. Specifically, if answer in Q1 is 0% then the binary data is 0, but answer in Q2 also is 3) or 4) then it is 1. The probability of a correct response item j in the Rasch model is given by:

$$p_j(\theta) = \frac{1}{1 + \exp(-Da(\theta - b_j))} \quad (4)$$

where θ is the standing on the underlying trait and b_j is the difficulty of item j . The variable a is the parameter of the logistic curve. We estimated accurate difficulty from the binary response data with rasch function of R software package “ltm” (Rizopoulos, 2006). Table 1 shows the difficulty values of the learning materials in descending order of difficulty.

4.2 Results

We evaluated difficulty rankings precision by comparing accurate difficulty ranking, and table 2 shows result of improved algorithm. We applied some measures such as NDPM (Yao, 1995) and Spearman's rank correlation. NDPM measure will give a perfect score of 0 when estimated ranking completely agrees with accurate ranking, and will give a worst score of 1 when reversed estimated ranking completely agrees with accurate ranking. A score of 0.5 represents that there is no correlation between estimated ranking and accurate ranking. The Spearman's rank correlation coefficient would be near 1 when estimated ranking and accurate ranking have positive correlation. -1 is a negative correlation and 0 is no correlation. Therefore, as you can see in table 3, the difficulty ranking estimated by improved algorithm is better than elemental algorithm. We implemented simple content-based algorithm for evaluation. This algorithm estimates difficulty of a web page from difficulty of terms and frequency of terms about C language in the page. We defined difficulty of terms from the page number of index of the best-known book (Kernighan and Ritchie, 1988) in

Table 1: Accurate difficulty values of the partial learning materials.

Label	M1	M2	M3	M4	M5	M6	M7	M8	M9	M10
Difficulty	1.19	0.71	0.49	0.39	0.19	0.00	0.00	-0.31	-0.41	-0.41
Label	M11	M12	M13	M14	M15	M16	M17	M18	M19	M20
Difficulty	-0.51	-0.61	-0.61	-0.94	-1.32	-1.32	-1.47	-1.62	-1.80	-1.80
Label	M21	M22	M23	M24	M25	M26	M27	M28	M29	M30
Difficulty	-2.00	-2.00	-2.23	-2.23	-2.51	-2.51	-2.51	-2.51	-2.89	-3.51

Table 2: Estimated difficulty ranking and values with the improved algorithm.

Label	M1	M2	M3	M4	M5	M6	M7	M8	M9	M10
Ranking	1	5	14	8	16	2	7	19	11	6
Difficulty	2.798	2.619	2.590	2.612	2.583	2.629	2.614	2.565	2.610	2.615
Label	M11	M12	M13	M14	M15	M16	M17	M18	M19	M20
Ranking	28	12	27	4	20	18	10	25	15	9
Difficulty	2.553	2.605	2.553	2.624	2.564	2.570	2.610	2.559	2.585	2.611
Label	M21	M22	M23	M24	M25	M26	M27	M28	M29	M30
Ranking	26	3	17	13	21	23	22	30	29	24
Difficulty	2.558	2.629	2.583	2.591	2.564	2.563	2.563	2.550	2.552	2.560

Table 3: Evaluation difficulty rankings by each ranking measures.

Metrics	Improved Algorithm	Elemental Algorithm	Content-Based Algorithm
NDPM	0.289	0.332	0.499
Spearman's Correlation	0.576	0.468	-0.07

Japanese edition. We suppose that the reason to become worse estimation precision of content-based algorithm is that the algorithm is too simple.

5. Conclusions

We have described difficulty estimation algorithm to recommend learning materials. The evaluation result of difficulty estimation of our improved algorithm is better than elemental algorithm. We would like to improve the algorithm more and develop a learning material recommender system using the algorithm. Bookmark data of a social bookmark site is untrustworthy because a user may bookmark an unread page. We think that read pages should estimate difficulty and proficiency. Unread bookmarks are suitable to be re-recommended because a learner certainly has an interest in the bookmarked learning materials.

Acknowledgements

This work was supported by JSPS KAKENHI Grant Number 25330364.

References

- Durand, G., Belacel, N. and LaPlante, F. (2013). Graph Theory Based Model for Learning Path Recommendation. *Elsevier Information Science*, 251, 10-21.
- Ghauth, K. I. And Abdullar, N. A. (2010). Learning Materials Recommendation Using Good Learners' Ratings and Content-Based Filtering. *Educational Technology Research and Development*, 58(6), 711-727.
- Guo, G., Erdt, M. H. and Lee, B. S. (2013). A Hybrid Recommender System based on Material Concepts with Difficulty Levels. *Proceedings of the 21st International Conference on Computers in Education*, 90-96.
- Kernighan, B. W., and Ritchie, D. M. (1988). The C programming language second edition. *Englewood Cliffs: prentice-Hall*.
- Kleinberg, J. M. (1999). Authoritative sources in a hyperlinked environment. *Journal of the ACM (JACM)*, 46(5), 604-632.
- Page, L., Brin, S., Motwani, R. and Winograd, T. (1999). The PageRank Citation Ranking: Bringing Order to the Web. *Technical Report*. Stanford InfoLab.
- Rizopoulos, D. (2006). ltm: An R Package for Latent Variable Modeling and Item Response Theory Analyses, *Journal of Statistical Software*, 17(5), 1-25.
- Skocir, P., Marusic, L., Marusic, M. and Petric, A. (2012). The MARS – A Multi-Agent Recommendation System for Games on Mobile Phones. *Agent and Multi-Agent Systems: Technologies and Applications, LNCS 7327*, 104-113.
- Yao, Y. Y. (1995). Measuring Retrieval Effectiveness Based on User Preference of Documents. *Journal of the American Society for Information Science*, 46(2), 133-145.

Exploring Student Interactions with Tutorial Dialogues in a Substep-based Tutor

Myse ELMADANI^a, Amali WEERASINGHE^b & Antonija MITROVIC^{a*}

^a*Intelligent Computer Tutoring Group, University of Canterbury, New Zealand*

^b*School of Computer Science, University of Adelaide, Australia*

*tanja.mitrovic@canterbury.ac.nz

Abstract: Understanding students' interactions with Intelligent Tutoring Systems (ITSs) allows us to improve the system as well as our pedagogical practices. Engaging students in tutorial dialogues is one of the strategies used by ITSs, which has been proven to improve learning significantly. This paper presents preliminary findings of a project that investigates how students interact with the tutorial dialogues in EER-Tutor using interaction videos in addition to eye-gaze data. We discuss some frequent misconceptions and behaviors student exhibited. Students usually focus on correcting one error at a time and then immediately submit their solutions to get feedback, thus not taking advantage of opportunities to reflect on what they have learnt. Based on the results, we identify several future directions of work on using eye-tracking for on-line adaptation.

Keywords: Substep-based Tutor, Tutorial Dialogues, Eye Tracking

1. Introduction

Studies of human one-on-one tutoring suggest that the student's behavior is a stronger predictor of learning gain than the tutor's behavior (Chi et al., 2001). Therefore, it would be beneficial to understand how students interact with ITSs. However, most evaluation studies involving ITSs focus on their effectiveness and do not explore student behavior deeper. In recent years, researchers have started analyzing student behaviors such as "gaming the system", or investigating how students attend to feedback (Baker et al., 2009; Conati, Jaques and Muir, 2013; Kim, Alevan & Dey, 2014).

We are interested in students' behavior while they solve problems in conceptual database modeling. EER-Tutor (Zakharov, Mitrovic & Ohlsson, 2005) is an ITS that teaches conceptual database design. We have enhanced EER-Tutor with tutorial dialogues (Weerasinghe, Mitrovic & Martin, 2009), which engage the student in discussing a mistake made. Tutorial dialogues help students learn relevant domain concepts as well as reflect on their errors. Many studies have shown the benefits of tutorial dialogues, such as (Evans & Michael, 2006; Graesser, 2011; Weerasinghe, Mitrovic & Martin, 2010).

Because we are mainly interested in the effect of dialogues on student behavior, we focus on students' actions following tutorial dialogues. For example, do students follow advice given in dialogues about how to correct errors? Verbal protocol analysis has been the dominant technique to analyze human tutoring. In this work, we analyzed student-system interaction videos and eye-tracking data. We describe our study and the version of EER-Tutor used in the following section. Section 3 presents the findings, while the final section presents our conclusions and future work.

2. Study

The interface of EER-Tutor (Figure 1) shows the problem statement at the top, the toolbox containing the components of the EER model, the drawing area on the left, and the feedback area on the right. Students' diagrams are checked for constraint violations on submission. The model for supporting tutorial dialogues is out of the scope of the current paper, and we refer the interested reader to (Weerasinghe, Mitrovic & Martin, 2009) for details. When a student makes one or more mistakes, s/he is presented with a tutorial dialogue. The problem statement, toolbar and drawing area are disabled but

visible for the duration of the dialogue, and the error is highlighted in red in the diagram. In the situation illustrated in Figure 1, the student has incorrectly modeled *facility* as a regular entity type, and EER-Tutor has highlighted it and provided a tutorial dialogue related to that error.

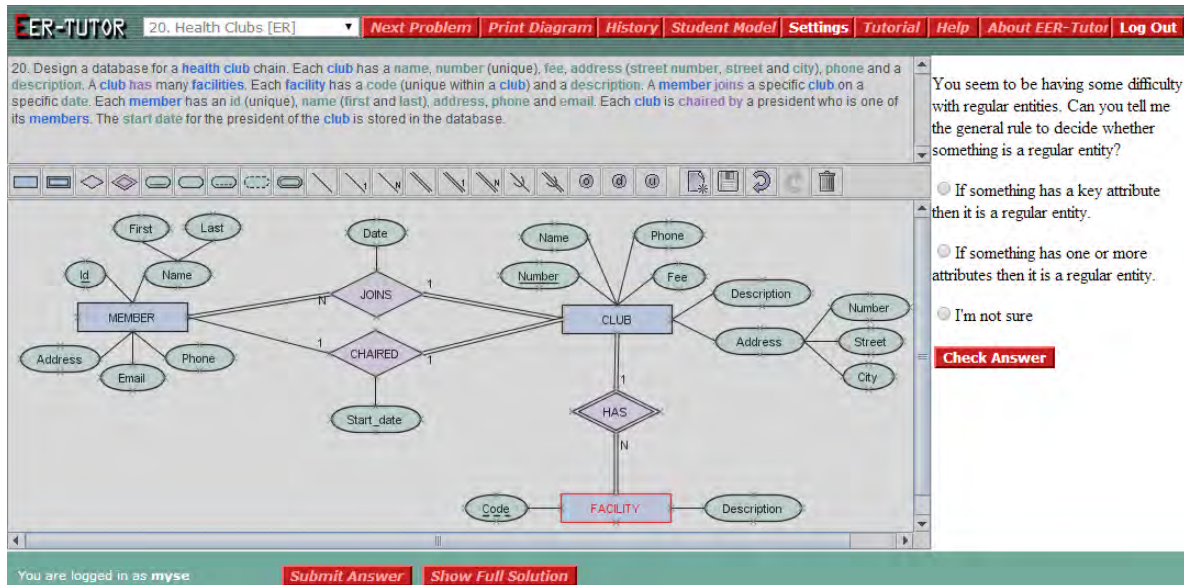

Figure 1. EER-Tutor interface after submission – the tutorial dialogue appears on the right

A dialogue consists of a sequence of questions, each with several possible answers. Such structure of tutorial dialogues allows multiple aspects of a single error to be discussed. The student answers by selecting an option, or asks for additional help (by selecting the “I’m not sure” option). Dialogues consist of the following prompt types:

- Conceptual (CO): discusses the relevant domain concept independently of the problem context. This is shown in Figure 1: the student has modeled *facility* as a regular instead of a weak entity type, so the conceptual prompt shown is asking about the basics of regular entities.
- Reflective (RE): aims to help students understand why their action is incorrect in the context of the current problem. For example, if the student answers the prompt in Figure 1 incorrectly, the RE prompt requires the student to specify why *facility* is not a regular entity type.
- Corrective action (CA): gives the student an opportunity to understand how to correct the error. For the error in Figure 1, the CA prompt is asking the student to specify the best way to model the *facility* and giving different options. Not all dialogues have this prompt type.
- Conceptual reinforcement (CR): allows the student to review the domain concept learnt. For the error in Figure 1, the CR prompt asks the student to identify the difference between a weak entity and a regular entity from the given options. Again, this is a problem-independent prompt.

The participants were 27 students enrolled in a database course at the University of Canterbury (9 females), aged from 18 to 50 years old (mean = 23.8, sd = 7.3). All participants had normal or corrected-to-normal vision. During the week prior to our study, the participants had used EER-Tutor in a regular lab session. Each participant was given a NZ\$20 voucher and took part in the study individually. One student was excluded because no eye-tracking data was collected

We used a version of EER-Tutor modified slightly to make eye tracking easier. A calibration phase with the eye tracker (Tobii TX300) was carried out at the beginning of the session. The participants could work on three problems and were free to move between problems. They were instructed to attempt all problems and to submit their solutions regularly. Each student was given 50 minutes to solve the problems. The mean session length was 49 minutes (sd = 3.1 min).

We have previously analyzed the difference in behavior between novices and advanced students on all three problems in (Elmadani, Mitrovic and Weerasinghe, 2013). In this paper, we focus on the first problem only (shown in Figure 1), and analyze the actions the students take immediately after tutorial dialogues. The mean time spent on the first problem is 16.1 minutes (sd = 8.7 min), with students making an average of 6.2 submissions (sd = 5.3). 17 students successfully completed the problem, three of whom had solved it previously and re-did it for the study.

We focused on the video segments beginning when the student submits his/her answer for the final dialogue prompt and ending when the student next submits their solution to the same problem, the session ends or the student switches to another problem. There were 111 such segments.

3. Findings

The completeness of the solutions at the point the students first asked for feedback varied. Nine participants submitted complete solutions as their first attempt (only one was error free). One student submitted a solution excluding connectors, participations, and cardinalities. This student may have wanted to check that s/he has the correct entities, relationships, and attributes before thinking about the associations between them. Relationship attributes were left out from otherwise complete solutions by four students, highlighting the concept's complexity.

We investigated the errors made when answering the final dialogue prompt, which represent common or deep misconceptions. These errors were made by more than one student, or made several times by the same student. There is a lack of understanding of the differences between regular and weak entity types, and related concepts. For example, each weak entity type must have exactly one identifying relationship type. Two participants mixed up which relationship type belonged with which entity type. Students also show misunderstanding about which key type belongs to which entity type.

The cardinality ratio of relationships is a similarly difficult concept. There were nine situations where students indicated that in order to determine the cardinality ratio of a relationship, you must ask how many instances of an entity participate with another entity. This is incorrect as you must think in terms of a single instance of the second entity. One student made this error four times (two of which were in consecutive dialogues but pertaining to separate errors), which suggests that the student was not applying the tutorial dialogue content beyond correcting the current error.

Participation is a concept related to the cardinality ratio, so students may confuse the two. Five students thought that when determining the participation of entities in a relationship type it was necessary to consider how many instances of an entity participate with a single instance of another entity. On the contrary, it is necessary to consider whether every instance of an entity participates in relationship instances. One student answered this prompt incorrectly twice despite being able to correct the participation the first time s/he saw the prompt. This indicates that s/he may be relying on the fact that there are two participation options and so just chose the other one to correct the error.

Once the student receives the final message of a dialogue, s/he can go back to editing the diagram. Regardless of whether the student reads or looks at that final message, the red error highlighting is almost always the next focus of attention. This visual cue is therefore beneficial to students as they are able to quickly locate the error and concentrate on its correction. In addition, for cases where there is no error highlighting on the diagram, the students fixate on the toolbar or problem statement straight away. This is consistent with the type of errors made, for example submitting a solution with a missing entity type and therefore searching for it in the problem statement.

There were 20 students who answered the final prompt correctly and fixed the error (in 60.4% of all segments). After the tutorial dialogue, the student is free to change the diagram. We identified several common patterns of changes done:

- *attempts_fix*: the student addresses the error but incorrectly
- *fix*: the student corrects the error
- *check*: the student inspects his/her solution or rearranges diagram components
- *similar*: the student corrects a similar error
- *related*: the student makes related changes
- *other*: the student continues working on other parts of the solution
- *problem*: the student looks at the problem statement
- *wrong_issue*: the student tries to fix the error by addressing the wrong issue

A correction is attempted in 93.7% of segments, with 82.0% of these fixes being correct (made by 22 students). There were seven segments during which the student did not attempt to correct the error but switched to a different problem instead. One participant did not understand the tutorial dialogue. After completing the dialogue, s/he examined the text of the problem and all components of the diagram, and then attempted creating another entity type which was not necessary. The participant was

clearly confused; s/he even looked at the other two problems before submitting the unchanged solution. This particular situation is illustrated in Figure 3 as a gaze plot generated by Tobii.

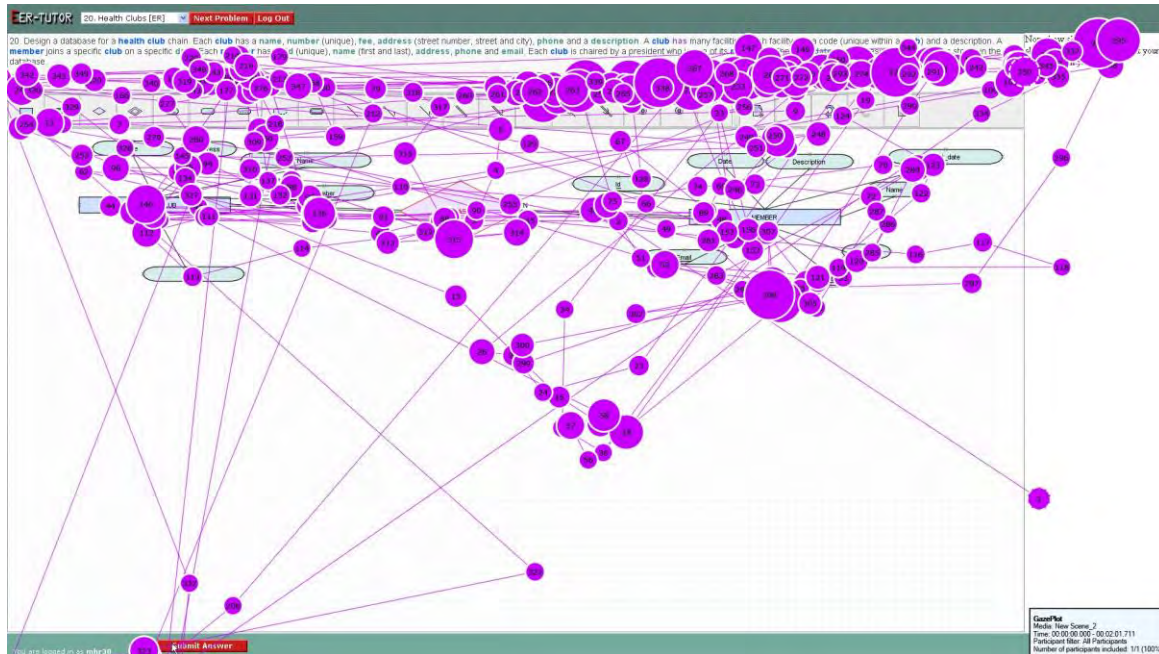

Figure 3. A gaze plot illustrating confusion

We also analyzed sequences of patterns following tutorial dialogues. There are 20 students who performed the *submit-fix-submit* sequence (row *a* in Table 1). That is, the student submitted his/her solution (*submit*), went through the tutorial dialogue, corrected the error (*fix*) and submitted the solution again (*submit*). A gaze plot illustrating this kind of situation is given in Figure 4. The student has submitted a solution with two mistakes, and received a dialogue about one of them. Upon completing the dialogue, the student quickly corrected their mistake, and submitted the modified solution for checking immediately. In this particular situation, there was another similar mistake in the solution, but the student has not taken the time to check the other parts of the solution.

Therefore, the dialogues may be encouraging shorter interaction sequences. Most participants addressed one error at a time and submitted their solutions to be checked immediately. With the exception of one student, students who solely followed this interaction pattern saw at most two multi-level dialogues (eight students in total). The next most frequent sequence (Table 1, row *d*) adds a single step, where the student checked his/her solution themselves before asking EER-Tutor for feedback. The other interaction patterns are shown in Table 1.

If the student has learnt from the dialogue, s/he should also be able to fix similar errors in the solution. This occurs in 7.2% of segments by six students (Table 1, rows *g*, *j*, *k*). These participants fixed the errors that are either the addition of missing constructs (relationship and cardinality) or correcting participation, cardinality or relationship type. Three of these students had also answered the final dialogue prompt correctly as well as fixing the error discussed in the dialogue (5.4% of segments).

If the student is reflecting on what s/he has learnt in a dialogue, s/he should be able to make related changes required. A related change is needed if the type of entity is changed for example, as the corresponding key and relationships would need modification. In 13.5% of segments, other related changes are required but these related changes are only made in 5.4% of segments (Table 1, rows *i* and *m*). Interestingly, there are no cases where a student fixed similar errors as well as made the required related changes. This is probably due to the relatively small number of components in this problem as there were limited opportunities to fix similar errors.

In 12.6% of segments, the student made further additions/deletions/changes to his/her solution prior to submission. These are situations in which the student continued to work on the problem or presumably decided to narrow the scope of his/her solution in order to focus on addressing the error discussed by the tutorial dialogue. 11 students demonstrated this behavior (Table 1, rows *e*, *h*, *i*, *k-m*).

There are cases where the student attempted to correct an error but did so by addressing the wrong issue (Table 1, rows *c* and *l*). One student, for example, had the wrong cardinality ratio but

changed the participation instead. A similar situation occurred where a student had the wrong relationship type and, despite answering the corrective action prompt correctly, changed the cardinality on one side of that relationship. In that situation, the student got the same dialogue again because the system selects the most frequent error. The student then addressed the error by removing the cardinality s/he just added and changed the participation for another relationship. It is not until the next submission that the student corrected the error, suggesting s/he finally focused on and/or understood the dialogue content. Another student had a missing relationship attribute and, instead of adding it, changed the relationship type. The tutorial dialogue explicitly mentioned that this relationship was modeled correctly and fixations appeared on the feedback area when this text is displayed. This suggests that the student may not have fully comprehended the dialogue.

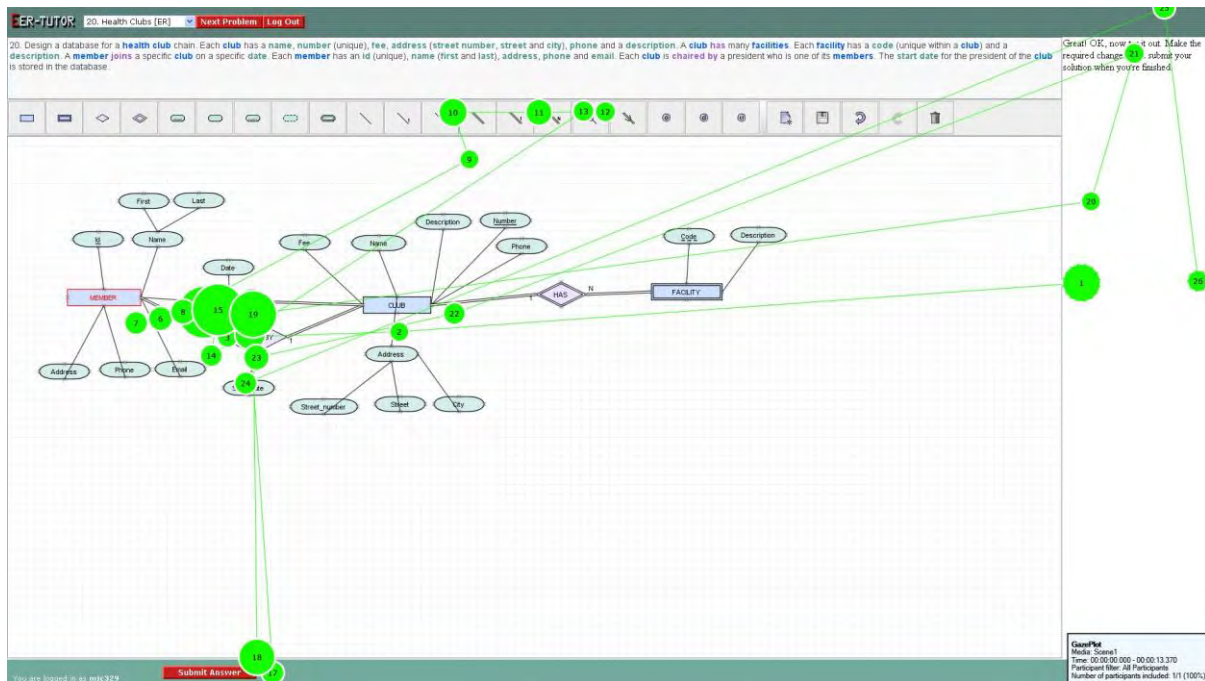

Figure 4. A gaze plot for the *fix* step of the *submit-fix-submit* sequence

Once the student has corrected or attempted to correct the error, ideally s/he should check the rest of the solution before submitting. Students inspected their solutions or rearranged diagram elements prior to submission in 19.8% of segments (Table 1, rows *d*, *h*, *j* and *m*). This kind of behavior was performed by 12 distinct students, at various stages of solution completion, ranging from one participant who checked the solution after each correction (two occasions in total) to a participant who checked the solution irregularly (after six out of 21 dialogues seen).

Table 1. Interaction sequences

	Pattern	Segments	Distinct Students
<i>a</i>	<i>submit - fix - submit</i>	64	20
<i>b</i>	<i>submit - attempts_fix - problem - submit</i>	1	1
<i>c</i>	<i>submit - attempts_fix - wrong_issue - submit</i>	2	1
<i>d</i>	<i>submit - fix - check - submit</i>	16	9
<i>e</i>	<i>submit - fix - other - submit</i>	6	4
<i>f</i>	<i>submit - fix - problem - submit</i>	1	1
<i>g</i>	<i>submit - fix - similar - submit</i>	5	3
<i>h</i>	<i>submit - attempts_fix - other - check - submit</i>	1	1
<i>i</i>	<i>submit - fix - related - other - submit</i>	3	3
<i>j</i>	<i>submit - fix - similar - check - submit</i>	2	2
<i>k</i>	<i>submit - fix - similar - other - submit</i>	1	1
<i>l</i>	<i>submit - fix - wrong_issue - other - submit</i>	1	1
<i>m</i>	<i>submit - fix - related - other - check - submit</i>	1	1

Following the submission of a correct solution, EER-Tutor gives a final feedback message: “*That’s correct, well done!*” From the eye-tracking data, we noticed that 59% of students who completed the problem read the feedback message whereas 24% only briefly looked in its direction. We had expected students to reflect on their correct solutions, but only 18% of students looked at and/or moved the cursor around the canvas or problem statement.

4. Conclusions and Future Work

Understanding students’ interactions with an ITS allows us to improve the systems as well as our pedagogical practices. We presented a study in which we investigated how students interact with tutorial dialogues in EER-Tutor, using eye-tracking data. When a student submits a solution for checking, EER-Tutor selects an error to be discussed via a tutorial dialogue. We analysed the effect of the dialogue on the student’s actions following the dialogue.

We found that most participants fixed the error discussed in the tutorial dialogue, and asked for feedback immediately. By focusing on the discussion of a single error, we may be encouraging this *submit-fix-submit* pattern. We also observed that students did not always reflect on their solutions after correcting the discussed error or successfully solving the problem. There are therefore opportunities for reflection that students do not take advantage of. If the system can identify the lack of reflection, (e.g. by identifying missed opportunities to improve the solution by fixing similar errors), the system can prompt the student to reflect and make these further changes. In addition, if the student demonstrates repeated behavior patterns, it may be beneficial to point out this behavior and to emphasize the importance of reflection. When analyzing the data from the study we also identified several minor improvements to the wording used in problems and dialogues used in the study.

Eye tracking provides a wealth of information which allows for further improvement of ITSs. We discussed a situation when the student did not understand a tutorial dialogue and was confused as the result. In such situations, the ITS could provide additional support, in the form of examples or additional explanations. Our future work will involve further studies of student behavior in EER-Tutor and enhancements to the system.

References

- Baker, R. S., de Carvalho, A. M. J. A., Raspat, J., Aleven, V., Corbett, A. T., & Koedinger, K. R. (2009). Educational software features that encourage and discourage “gaming the system”. In *Proc. 14th Int. Conf. Artificial Intelligence in Education* (pp. 475-482).
- Chi, M. T., Siler, S. A., Jeong, H., Yamauchi, T., & Hausmann, R. G. (2001). Learning from human tutoring. *Cognitive Science*, 25(4), 471-533.
- Conati, C., Jaques, N. & Muir, M. (2013). Understanding attention to adaptive hints in educational games: an eye-tracking study. *International Journal of Artificial Intelligence in Education*, 23(1-4), 136-161.
- Elmadani, M., Mitrovic, A., & Weerasinghe, A. (2013) Understanding student interactions with tutorial dialogues in EER-Tutor. *Proc. 21st Int. Conf. on Computers in Education*, Bali, (pp. 30-40). Uhamka Press.
- Evans, M., & Michael, J. (2006). *One-on-one Tutoring by Humans and Computers*. Lawrence Erlbaum Associates.
- Graesser, A. C., Franceschetti, D. R., Gholson, B., & Craig, S. D. (2011). Learning Newtonian physics with conversational agents and interactive simulation. In N. L. Stein & S. Raudenbush (Eds.), *Developmental cognitive science goes to school* (pp. 157-172). New York: Routledge.
- Kim, S., Aleven, V., & Dey, A. K. (2014). Understanding expert-novice differences in geometry problem-solving tasks: a sensor-based approach. *CHI’14* (pp. 1867-1872). ACM.
- Weerasinghe, A., Mitrovic, A., & Martin, B. (2009). Towards individualized dialogue support for ill-defined domains. *Int. Journal of Artificial Intelligence in Education*, 19(4), 357-379.
- Weerasinghe, A., Mitrovic, A., Martin, B. (2010) Evaluating the effectiveness of adaptive tutorial dialogues in database design. *Proc. 18th Int. Conf. Computers in Education*, (pp. 33-40). APSCE.
- Zakharov, K., Mitrovic, A., & Ohlsson, S. (2005). Feedback micro-engineering in EER-Tutor. In: C-K Looi, G. McCalla, B. Bredeweg, J. Breuker (Eds.) *Artificial Intelligence in Education* (pp. 718-725). IOS Press.

Gaze Analysis and Subjective Assessment of Learners Observing the Writing Process

Yasuhisa OKAZAKI^{a*}, Senju NOGUCHI^b & Atsushi YOSHIKAWA^c

^a Graduate School of Science and Engineering, Saga University, Japan

^b Department of Information Science, Saga University, Japan

^c Interdisciplinary Graduate School of Science and Engineering, Tokyo Institute of Technology, Japan

* okaz@ai.is.saga-u.ac.jp

Abstract: We used subjective assessments from learners as well as eye trackers for gaze analysis to investigate and analyze differences between two cases: when learners were presented with a writing process, such as on a chalkboard, and when only the final results of writing were presented. The results indicate a relation between subjective learner assessment and gaze. More specifically, there were differences in gaze between learners who reported that watching the writing process was beneficial to learning and those who reported otherwise. We discuss the influences on understanding that result from showing the writing process and propose new ideas for presentation named “information push” and “information pull”.

Keywords: gaze, eye tracker, writing process, chalkboard, slide

1. Introduction

As a method of presenting information in class, the slide presentation or chalkboard is often used. Although slides have many benefits, not a small number of teachers and learners prefer classes with traditional chalkboards in preference to presentation slides (Yanagisawa & Fukuda, 2008), and many teachers use their experience, knowledge, and teaching skill to determine how a variety of information should be presented to learners.

One of the predominant features of the traditional methods of presenting information on a chalkboard is that learners watch information presentation as it is being written (Brown, 2012; Jones, et al., 1994). Research is currently being performed that focuses on such features to examine the benefits of presentations that incorporate representations of the writing process (Bandoh et al., 2002; Kurihara, 2006).

We consider that chalkboard presentation represents a visualization of the thought process, and thus is far richer in educational information than simple presentation of final results. Presentation slide has advanced features such as animations, but these features are simply methods for drawing attention or mechanically creating sequential divisions, and do not reflect the structure or thought process behind the object being displayed. Showing this process has meaning with regard to understanding, and is different from presentation of completed forms or mechanical step-by-step presentations.

We focused on learners' gaze as fundamental data for elucidating the benefits of presenting the writing process (Okazaki et al., 2013). For presentation materials, we selected prime factorization and geometric proofs as topics for experimental problems where displaying the writing process can be examined in relation with comprehension of the topic. We used subjective assessments from learners as well as eye trackers (a system for following the path of a person's gaze) (Duchowski, 2007; Ohno, Mukawa & Yoshikawa, 2002) for gaze analysis to investigate differences between the case where learners are presented with the writing process, such as writing on a chalkboard, and the case where only the final results of the writing are presented.

2. Methods

We used the following method to measure participants' gaze. Tobii T60 Eye Tracker was used to track gaze (Tobii T60 & T120 Eye Tracker, 2013). This eye tracking system is a standalone eye tracking unit integrated in a 17-inch TFT monitor. No sensors or other hardware elements are visible to distract the user. The system detects user's gaze by both bright and dark pupil tracking eye tracking technique with 60Hz data rate and typical 0.5 degrees accuracy.

Participant gaze was measured by the following method. There were 16 participants (12 men and 4 women). Experiments were performed over 4 days: November 22, November 29, December 3, and December 10, 2013.

Figure 1 shows the presentation stimuli, which comprised two prime factorization problems and two geometric proofs. Each problem was presented in two ways—a presentation that included the writing process and another that showed only the final results of writing—for a total of eight presentation patterns.

Presenting the writing process provides students with a focal point that learners' gaze can follow. A presentation that includes the writing process reproduces the thought process during problem solving, which likely serves to support comprehension. We created presentation stimuli using a presentation tool, HPT (Handwriting Presentation Tool), currently in development at our laboratory (Hosoki et al., 2011). This tool allows for reproduction of the writing process such as when writing on a chalkboard.

We used Tobii Studio for analysis of gaze data (Tobii Studio, 2013). We used gaze plots for dynamic analysis, and heat maps for static analysis.

(a) Prime factorization 1

(b) Prime factorization 2

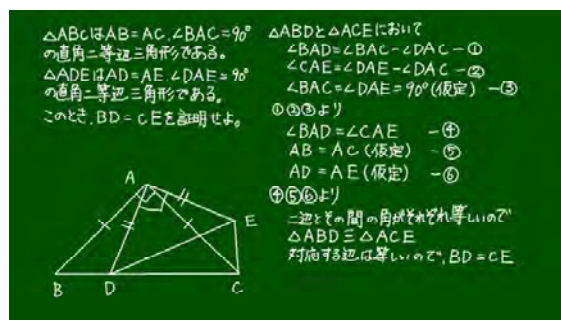

(c) Geometric proof 1

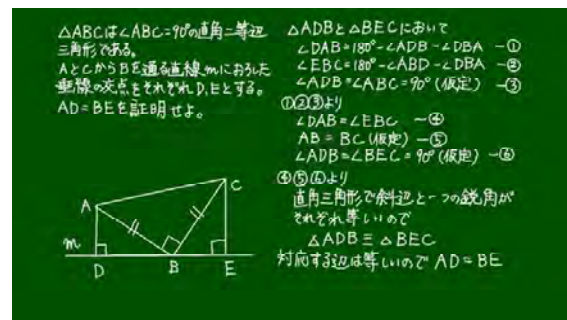

(d) Geometric proof 2

Figure 1. Presentation stimuli

3. Results

3.1 Comprehension check results

Figure 2 shows the ratio of correct answers for the comprehension check. Correct answer rates were higher when the writing process was shown for the prime factorization problem 2, but for the other cases, the rates were the same as or lower than when the writing process was not shown. Although we

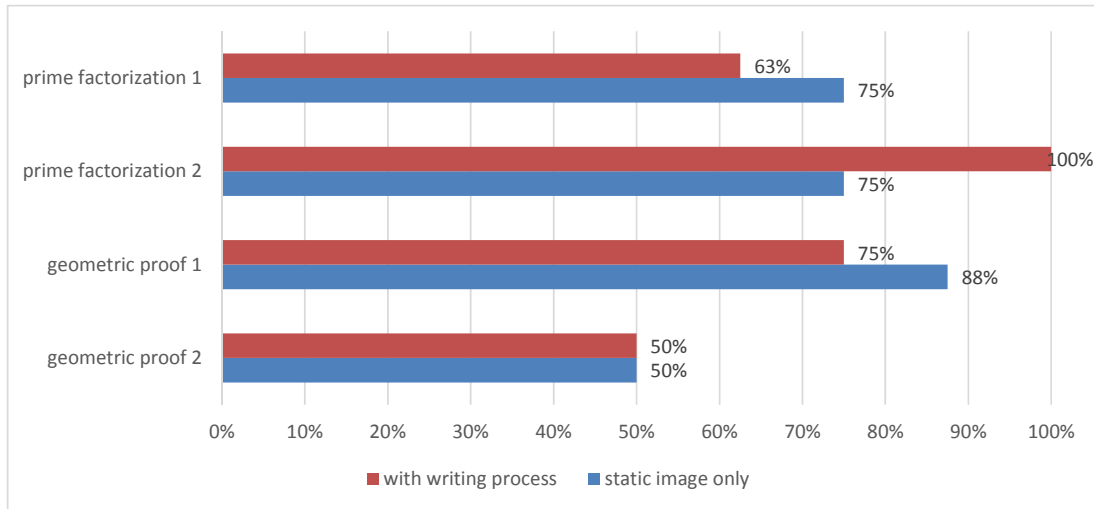

Figure 2. Ratio of correct answers for the comprehension check

Table 1: Questionnaire survey for subjective learner assessment

Writing process is helpful	prime factorization	geometric proof
Strongly agree	2	8
Agree	6	3
Neutral	4	1
Disagree	3	3
Strongly disagree	1	1

predicted that showing the writing process would support student learning, and that this result would be supported by a difference in comprehension check scores, we were unable to obtain data indicating this.

3.2 Subjective assessment

Table 1 lists items in the questionnaire survey used for subjective learner assessment. While no difference was seen in the correct answer rate for the examined problems, a difference was seen in responses to the questionnaire. For both the prime factorization problem and the geometric proof, participants reported that they preferred being shown the writing process. For the geometric proof problem in particular, half of the participants reported a strong preference for being shown the writing process, and when responses indicating a mild preference are included, approximately 70% of students preferred being shown the writing process. In contrast, only about half of the students indicated a preference for being shown the writing process for the prime factorization problem.

3.3 Gaze analysis

3.3.1. Participants for gaze analysis based on subjective assessment

As described in sections 3.1 and 3.2, we saw no difference in correct answer response rates between the cases where the writing process was or was not shown, but participants tended to prefer being shown the writing process. Upon investigating individual responses regarding this preference for being shown the writing process, we found 4 participants who reported a preference for being shown the writing process for one of the two problem types (prime factorization or geometric proof), but for not being shown the writing process for the other. We selected these 4 participants for a follow-up gaze analysis. We designated the 2 participants who reported a preference for being shown the writing process for prime

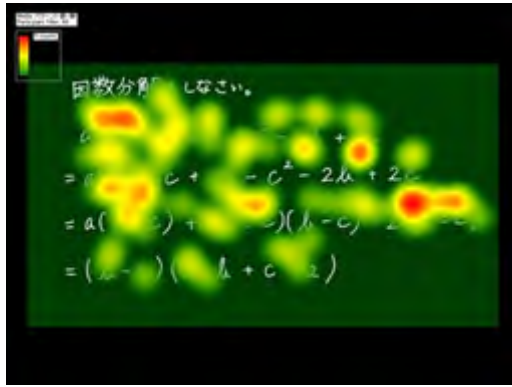

(a) The writing process is presented

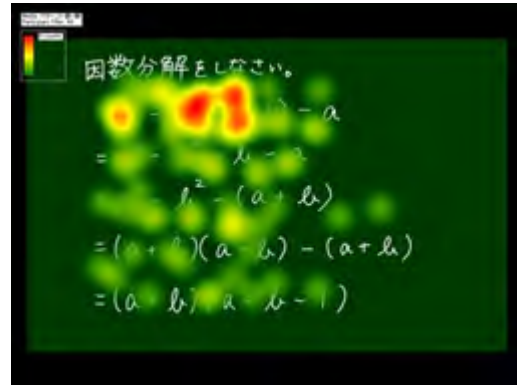

(b) The static image is presented

Figure 3. Heat map examples of participant A

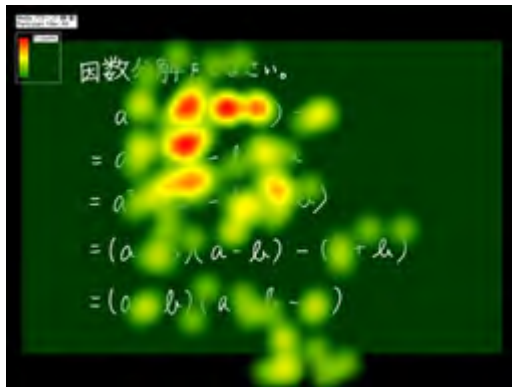

(a) The writing process is presented

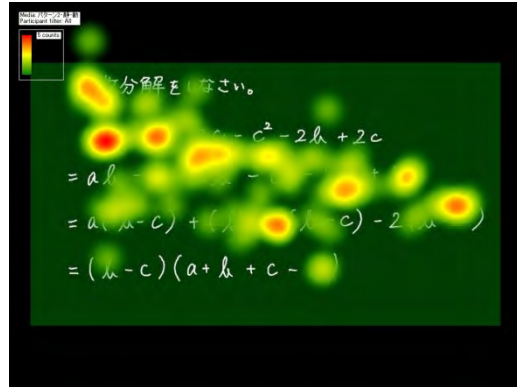

(b) The static image is presented

Figure 4. Heat map examples of participant C

factorization but not for the geometric proof as A and B, and designated the 2 participants who indicated the opposite preference as C and D.

3.3.2. Gaze analysis for the prime factorization problem

A gaze plot for participants A and B revealed that they followed the writing process when it was shown, but that eye movement was faster and less time was spent examining the presentation when the writing process was not shown. In contrast, the eye movements of participants C and D were slower in both cases, following the presentation when the writing process was shown and reading the presentation more carefully when it was not.

This difference can be seen in the heat maps shown in Figure 3. The heat maps of participants A and B differed between the cases where the writing process was or was not shown. When the writing process was shown the participants were able to focus on the process, and many focal points were seen (Fig. 3(a)). When the writing process was not shown, there was a tendency to quickly scan the entire presentation, indicating that less attention was paid (Fig. 3(b)). In contrast, participants C and D paid close attention to the presentation regardless of whether the writing process was shown, so there was little difference in their heat maps between the two cases (Fig. 4(a)(b)).

3.3.3. Gaze analysis for the geometric proof

No difference in the gaze was seen between participants C and D, who reported a preference for being shown the writing process for the geometric proofs, and participants A and B, who reported a preference for not being shown the writing process for those problems. Analysis of the gaze plots for each of the 4 participants did not show differences in their gazes, but some similar features were observed.

4. Discussion

As discussed above, a difference was seen between participants A and B with respect to their understanding of the process of manipulating the equations for the prime factorization problem. This difference depended on whether they had been shown the writing process, which promoted attention toward the process of manipulating the equation, resulting in differences in eye movement. This might have led to differences in subjective evaluation.

In contrast, participants C and D placed less of a priority on seeing the writing process when manipulating equations for the prime factorization problems, and they showed similar focus even when the writing process was not shown. These indicate that presenting the writing process promoted an attention effect, and that there was an effect of attention neglect when only a static image was presented.

In the case of the geometric proofs as well, when the writing process was presented to show the characters and symbols representing the geometric elements (angles and sides), participants looked at the associated parts in the figure, which might have provided a trigger promoting verification of the relation between the elements in the figure.

In the solution process to the right of the geometric proofs, there were cases where a participant's gaze did not follow the equation manipulation, despite the writing process being shown. This was possibly because the process of equation manipulation was somewhat difficult and proceeded while learners were thinking and making verifications. In other words, it is possible that the presentation of the writing process was too fast, resulting in a loss of effectiveness.

In contrast, when a static image was shown we saw participants looking at the associated parts of the figure after viewing the equations or after looking at several equation manipulations, indicating that they were confirming the summary of what had occurred.

From gaze analysis, we suggest that presenting the writing process provided a focal point for attention and that the speed and timing of that focal point was important. For those participants who indicated a preference for not being shown the writing process, it is possible that the speed and timing of the presentation was not well suited to them.

Showing the writing process allowed for showing the procedures, relations, and ways of grasping the diagram. It also provided focal points, likely providing a mechanism for focusing attention on the process. When the final results were summarized through presentation of a static image, learners shown this information were able to interpret information obtained on their own.

We call the first case, where information including processes is actively provided, "information push", and the second case, in which the recipients (i.e. learners) derive information themselves, "information pull." Showing the writing process is a form of information push, promoting attention and providing explicit information about individual elements and their relations. In this case, the speed and timing of presentation are important, and care must be taken to tailor the presentation to learners. Showing final results as a static image is a form of information pull, and requires that learners derive for themselves the individual elements and their relations. Information pull does not provide attention focuses or processes, but allows for a higher degree of freedom in interpretation. The appropriateness of providing such a degree of freedom likely varies with individual learners.

Information pull is appropriate for learners who can read problems and independently discover their meaning and identify important problem elements and relations. Information push, with appropriate speed and timing, is best suited for learners who require support in making such discoveries.

In courses where instructors write on a chalkboard, the instructors can monitor student responses and thereby adjust the speed and timing of the presentation. We believe that this makes information push effective, thereby leading to an easier-to-understand class.

5. Conclusions and future topics

We have used subjective assessments from learners as well as eye trackers for gaze analysis to investigate and analyze differences between two cases: when learners are presented with a writing process and when they are not. Some participants reported that presentation of the writing process was effective, although others reported that it was not. Differences in gaze were seen between these groups, and we found the possibility that presentation of the writing process can lead to better ease-of-understanding under certain conditions.

Presentation of the writing process provided learners with focal points for attention and let them see how to grasp the subject matter and relations within it. Those who preferred being presented with the writing process were likely those who needed support in understanding the presented information. Conversely, those who preferred not to be presented with such an active display of information were likely those who found it to be a restriction on their free interpretation.

In cases of high readiness for the displayed information, information pull (presenting the final results) is more appropriate due to the freedom of interpretation it provides. In other cases, information push (presenting the writing process) with appropriate speed and timing may be preferable.

In future research, we will investigate in more detail the cases in which information push and information pull methods of information presentation are more effective. We will also perform actual experiments to investigate these differences, thereby revealing how these two methods of information presentation should be implemented.

Acknowledgements

This work was supported by JSPS KAKENHI(Grant-in-Aid for Scientific Research(C)) Grant Number 24501193. We would like to thank Prof. Takaaki Sonoda and Ms. Rimi Nakamura at Integrated Center for Educational Research and Development of the Faculty of Culture and Education in Saga University for their kind support and cooperation in this research. We also thank to all staffs and students who cooperated in our experiment.

References

- Bandoh, H., Sugizaki, T., Kato, N., Sawada, S. & Nakagawa, M. (2002). Architecture and prototyping of the middleware for an electronic blackboard aimed at the computerization of lectures, *IPSJ Journal*, 43(3), 804-814.
- Brown, A. (2012). The Advantages of Using Chalkboards in Teaching, http://www.ehow.com/list_5872788_advantages-using-chalkboards-teaching.html
- Duchowski, A. T. (2007). *Eye Tracking Methodology: Theory and Practice*, Springer.
- Hosoki, A., Tanaka, H., Watanabe, K., & Okazaki, Y. (2011). Development of a New Presentation Tool for Cognitive Enhancement by Controlling the Whole Writing Processes, *Work-In-Progress Poster(WIPP) Proceedings of the 19th International Conference on Computers in Education(ICCE2011)*, 24-26.
- Jones, et al. (1994). CHALKBOARD Based on excerpts from The Expert Educator, www.neiu.edu/~sdundis/hrd362/chlkbdr.pdf
- Kurihara, K. (2006). A Study on Software Tools for Flexible Presentations, *The ACM Symposium on User Interface Software and Technology Doctoral Symposium*.
- Ohno, T., Mukawa, N. & Yoshikawa, A. (2002). FreeGaze: a gaze tracking system for everyday gaze interaction, *Proceedings of the symposium on ETRA 2002: eye tracking research & applications symposium*, 125-132.
- Okazaki, Y., Noguchi, S., Tanaka, H., Watanabe, K., Yoshikawa, A. (2013). Eye tracker gaze analysis of learners watching the writing process, *Proceedings of the 21st International Conference on Computers in Education (ICCE2013)*, 373-378.
- Tobii Studio - Eye Tracking Software for Analysis. (2013). <http://www.tobii.com/en/eye-tracking-research/global/products/software/tobii-studio-analysis-software/>
- Tobii T60 & T120 Eye Tracker. (2013). <http://www.tobii.com/en/eye-tracking-research/global/products/hardware/tobii-t60t120-eye-tracker/>
- Yanagisawa, M. & Fukuda, S. (2008). Survey Research on Note Taking in the Lecture using Backboard and Presentation Soft, *RESEARCH REPORT OF JSET CONFERENCES*, 2008(5), 63-68.

Interactive Environment for Learning by Problem-Posing of Arithmetic Word Problems Solved by One-step Multiplication and Division

Sho YAMAMOTO^{a*}, Yuki AKAO^a, Mitsutaka MUROTSU^a, Takehiro KANBE^a, Yuta YOSHIDA^a, Kazushige MAEDA^b, Yusuke HAYASHI^a & Tsukasa HIRASHIMA^a

^aGraduate School of Engineering, Hiroshima University, Japan

^bElementary School Attached to Hiroshima University, Japan

*sho@lel.hiroshima-u.ac.jp

Abstract: Problem-posing is effective learning for comprehending problem structure. We have designed and developed the learning environment for problem-posing and performed its practical use for first and second grade students on elementary school continually. The scopes of these systems are one-step addition, subtraction or multiplication arithmetic word problem. The results of these practical uses suggested that the learning environment was effective to comprehend these problem structures. Therefore, as the next step, we have designed and developed a learning environment for posing one-step multiplication or division word problem in order to let learners acquire a difference between multiplication and division. Developed learning environment and its practical use in an elementary school are reported.

Keywords: Problem-posing, sentence-integration, interactive environment, multiplication, division, arithmetic word problem, problem structure

1. Introduction

Several researchers postulate problem-posing is effective exercise for promoting learners to master the use of solution methods (Polya, 1945; Silver, CAI, 1996). Moreover, it has been proposed that poor problem solvers often fail to elicit problem structures from problem (Mayer, 1982; Kintsch, Greeno, 1985). We design and develop the learning environment which learners acquiring the structure of arithmetic word problem by exercising the problem-posing. Now, our research domain is an arithmetic word problem can be solved by one-step calculation operation. We analyze a structure of arithmetic word problem and develop the learning environment based on its structure (Nakano, et al, 1999; Hirashima, et al, 2007; Hirashima, et al, 2011). Until now, one-step addition, subtraction or multiplication word problem are analyzed and the structure of these problems are implemented on tablet PC (Yamamoto, et al, 2012; Yamamoto, et al, 2013). In addition to the development, we have performed two experimental uses with elementary school teacher, which are first grade students by learning the one-step addition or subtraction and second grade students by learning the one-step addition or subtraction word problem. As this reason, the first grade students have learned the problem-posing by one-step addition or subtraction word problem because they have already known the concept of addition and subtraction in their life. The second grade students only learned to pose one-step multiplication problem because the concept of multiplication is a difficult concept for learners. The results of these experimental uses have proposed that not only the learner improve the problem solving performance, but also this learning environment was effective for the learner who can't judge the problem structure to acquire the problem structure.

The students are only required to consider the multiplication problem structure by learning the assignment of learning environment for second grade student, As the next step, the learner learn not only one-step multiplication but also one-step division word problem. Therefore, they are required to judge whether the story means one-step multiplication or division. For this learning, we have designed a assignment and developed the learning environment by problem-posing. In this paper, a problem structure is explained in the following chapter. A design of developed learning environment based on

this structure is described in section 3. A sequence of assignment is also explained. Subsequently, a procedure of its practical use and an analysis of the results are reported.

2. Problem Structure of One-step Multiplication or Division Word Problem

In this section, the model of one-step multiplication or division arithmetic word problem is explained. One-step arithmetic word problems can be expressed by three sentences in our research. Example is shown in Figure 1. Because there are three values in one-step arithmetic word problem, this problem can be expressed by three sentences. Each sentence consists of value, object and predicate. These sentences consist of two sentences mean existence and one sentence means relation between other two values. We call each sentence as existence sentence and relation sentence. In this example, "There are three boxes" and "There are several apples" are existence sentence. "There are five apples in each box" is relation sentence because this sentence shows the relation between the apple and box.

In addition to the kind of sentence, each sentence has a property of quantity in multiplication and division word problem (Yamamoto, et al, 2013). Generally, multiplication is expressed by "multiplicand multiplied by multiplier is product" (Greer, 1992; Vergnaud, 1983). So, it is said that each quantity has different property. This word problem contains the story that the value of apples is expressed as the amount of apple when there are three boxes and the value of apples in each box is basis. Since, in Japanese Education, multiplicand is also called "base quantity", multiplier is "proportion" and product is "compared quantity". Then, the arithmetic word problem that can be solved by one-step multiplication or division has three types of story. (1) Compared quantity divided by base quantity is proportion, (2) Base quantity multiplied by proportion is compared quantity, (3) Compared quantity divided by proportion is base quantity. The story of the problem in Figure 1 is (2).

All of these stories contain the relation that is "Base quantity multiplied by proportion is compared quantity". One-step multiplication or division word problems are expressed by changing the one quantity to required value in each story. Therefore, it is important to extract the base quantity, proportion and compared quantity from problem and to make the relation between these quantities.

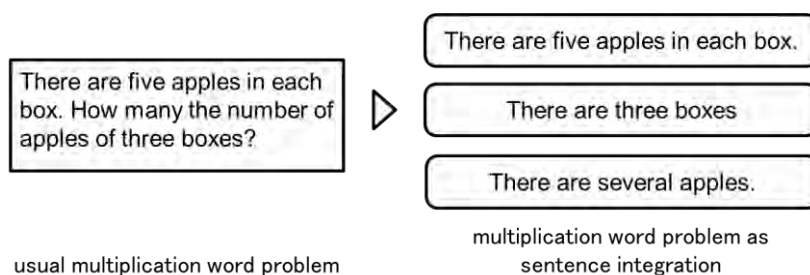

Figure 1. Example of Problem Expression as Sentence Integration.

3. Outline of Learning Environment for Problem-posing "MONSAKUN Touch3"

3.1 Framework

This learning environment consists of MONSAKUN Touch 3 for learners and MONSAKUN Analyzer 3 for teachers. A result of the learner's learning by problem-posing on MONSAKUN Touch 3 is sent to database server via network. MONSAKUN Touch 3 developed by using Android, MONSAKUN Analyzer 3 by using PHP and JavaScript. Of course, the each software can be run on Android Tablet. RDBMS is used MySQL. The teacher can confirm the graph of learner's learning by using MONSAKUN Analyzer 3 that receives a learning data from database server. The learning data are saved as three data: the number of correct problem, the number of incorrect problem, the number of the each incorrectness and the learner's log. Category of incorrectness is based on a diagnosis of MONSAKUN Touch 3. MONSAKUN Analyzer 3 generates some graph by using these data and displays teacher it. Teacher can limit to an assignment that learner can exercise on MONSAKUN Touch 3 by using MONSAKUN Analyzer 3.

3.2 MONSAKUN Touch 3

3.2.1 Outline of MONSAKUN Touch 3

In MONSAKUN Touch, after the learner logged in the environment and selected level, he/she sees an interface for problem-posing. This interface presents the assignment for posing problem, the set of given sentence card and three blank for arranging given sentence cards. The learner can pose the problem by selecting three sentence cards from given cards and arranging them in proper order. Given sentence cards are consists of correct card set and dummy card set for leading to errors. If three blank is filled with three sentence cards, diagnosis button will be active. Then, the learner can tap this button and the system diagnoses and generate a feedback his/her posed problem. When the learner finishes answering all assignment in selected level correctly, the interface for posing problem backs to the interface for selecting level. These flow and method of exercise are same as previous MONSAKUN. However, in MONSAKUN Touch 3, the text means the property of quantity is shown in the left side of each blank because let the learner consider the property of each sentence. The assignment that is described next section is renewed.

3.2.2 Designing the Level of Assignment

Table 1 shows the all level of assignment by dividing into the number of level, assignment, required activity, contents of assignment and number of assignment. Each level is designed so that the learner acquires to judge the structure of one-step multiplication or division word problem. The learner is required to pose the story from level 2 to 7, to pose the problem from level 8 to 9.

In level 1, the learner is given the story of one-step multiplication and four calculation expression which are expressed by "Base quantity multiplied by proportion is compared quantity", "Proportion multiplied by base quantity is compared quantity" and the cumulation of same number like " $4+4+4=12$ " and " $3+3+3+3=12$ ". This assignment is the confirmation of the relation between multiplication and addition. Then, the learner is required to select the correct calculation expression. The purpose of this level is which let the learner comprehend the relation of multiplication story and addition calculation. The learning environment gives the story and several sentence cards to the learner in level 2. The given story as sentence integration consists of two fixed sentence cards and one blank. The learner is required to fill this blank by considering the property of quantity. In this assignment, they learn the property of quantity that is contained each given sentence card. Given sentence cards in level 3 are included two sentence cards that have different text representation and same property. For example, "There are two boxes." and "The number of box is two.". In this level, let the learner learn that the sentence cards include the same property of quantity have various text representation. MONSAKUN Touch 3 present the three blank for putting the sentence cards and several sentence cards in level 4. Then, the learner is required to pose the story by selecting three sentence cards and by arranging them in proper order based on the relation of "Base quantity multiplied by proportion is compared quantity". The assignment of level 5 requires the learner to pose the two stories by using one common sentence card. Through this exercise, the learner comprehend that existence sentence card is able to have two property of quantity. In other words, both proportion and compared quantity are expressed by existence sentence. After that, in level 6, the learner learns that the story has three kinds of calculations expression that are mentioned in section 2. This purpose is that the learner notices the multiplication story contain the calculation (a) and (c). Thus, the learner is given the multiplication and division calculation expression as assignment for posing story. In order to let the learner confirm three properties of quantity and its relation again, assignments of level 7 includes improper assignment which cannot solve because of lack of one proper sentence card. Then, the learner is given a specific sentence card for posing the story in this level, which is labeled "proper sentence card is not given" instead of lacking sentence card. Because the assignments in level 7 are composed of usual assignment and assignment which mentioned above, the learner is required to consider each property of quantity and its relation again. As the next step, the learner is required to pose problem in level 8 because the learner learn to pose the story through level 2 to 7. Finally, in level 9, the learner is required to pose the two problems by using one common sentence card. This assignment is same as assignment of level 5. Through the exercise from level 1 to 9, the learner can acquire the problem structure gradually.

Table 1: The Assignment Level on MONSAKUN Touch 3.

Level	Required activity	Contents of assignment	Number
1	Select calculation expression	Select calculation express given story	12
2	Pose story	Pose story that is expressed by given calculation (one-step multiplication) Required story has already given two sentence cards	12
3	Pose story	Same as assignment of level 2 Include same property and different text representation	12
4	Pose story	Pose story that is expressed by given calculation (one-step multiplication) Select three sentence cards and arrange them	10
5	Pose story	Pose two stories by using same sentence card	10
6	Pose story	Pose story that is expressed by given calculation But given calculation expression is one-step multiplication or division	12
7	Pose story	Same as assignment of level 6 But one proper sentence card is not given	12
8	Pose problem	Pose problem that is expressed by given calculation Select three sentence cards and arrange them	12
9	Pose problem	Pose two problems by using same sentence card	12

3.3 Outline of MONSAKUN Analyzer 3

After the teacher log in the learning environment by inputting id and password, MONSAKUN Analyzer displays the visualized learning data like Figure 2. These data are consists of the average score of the problem-posing and rate of each incorrectness in his/her each lesson. These data generates and shows as a three bar charts and a doughnut chart. Moreover, this environment indicates the average achievement of the level and assignment number. The count of posed problem and the rate of incorrectness are showed by not only each lesson but also each student. This function is same as previous system. In addition to this function, MONSAKUN Analyzer 3 can extract the data based on the each level and assignment from these data. For example, teacher can see the learning data of level 4. The progress of number of correct and incorrect posed problem is visualized by line chart.

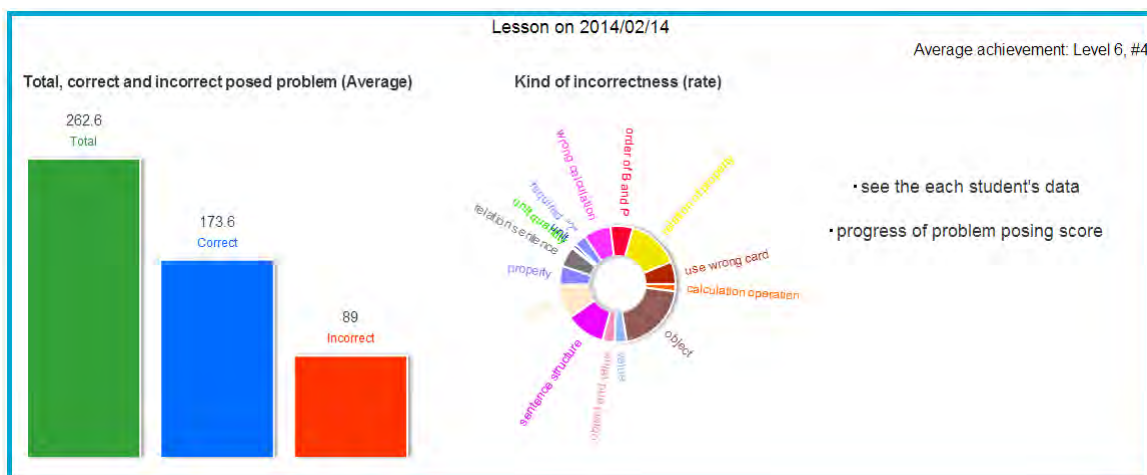

Figure 2. The Part of Main Interface of MONSAKUN Analyzer.

4. Experimental Use of MONSAKUN Touch 3

4.1 Procedure of Experimental Use

The subjects were thirty-nine students in the third grade of an elementary school. They were divided into the subjects who experienced MONSAKUN Touch 1 and 2 in our previous research (Yamamoto, et al, 2012; Yamamoto, et al, 2013) and who did not experience it. Also, they had just learned to solve arithmetic word problems that can be solved by one-step multiplication or division. This experimental use has been performed during thirteen lessons that consist of pretest in one lesson, learning by MONSAKUN Touch 3 in eleven lessons and posttest in one lesson (45 minutes per lesson, in 5 weeks). A lesson by using MONSAKUN composes of teaching about problem-posing by a teacher and problem-posing exercise by using MONSAKUN Touch 3. The time of using MONSAKUN Touch 3 is decided by the teacher based on the progress of each lesson. If the subjects have finished twice the current level when they exercise the problem-posing after teaching, they were allowed to work on the previous level. The purpose of this experimental use is to examine the effects of the learning by MONSAKUN Touch 3 and the effects of experience MONSAKUN continually.

We used these three tests: usual problem solving test, extraneous problem solving test and problem-posing test. Usual problem solving test can be solved by one-step multiplication or division that is expressed by three sentences. Usual problem solving test has sixteen questions because each quantity can be the required value in these five stories. Extraneous problem solving test includes extraneous information that is not necessary to solve the problem (Muth, 1992). The extraneous problem solving test is useful to assess learner's comprehension of the problem structure. These problems consists of twelve problems that including the two kinds of extraneous information that change sentence cards except sentence contains required value in each six stories. Problem-posing test examine the problem-posing performance to let the subject pose the problem as he/she can within the time limit. The subject pose problem from scratch. The time limit is ten minutes in each test. The difference between pretest and posttest is order of each problem.

4.2 Analysis of Pretest and Posttest

Analysis of pretest and posttest are reported in this section. And the level by using lecture is described. The teacher performed the lecture based on the level on MONSAKUN Touch 3 and treated one level in one lecture. However, in level 3, it is difficult for the subjects to relate between multiplication calculation expression and text representation contain "cut" because "cut" is associated with division calculation expression. Thus, the teacher has to spend three lessons for resolving this difficulty.

The results of average score and SD in three tests are shown in Table 2. These scores are divided into experienced and inexperienced group of MONSAKUN in our previous research. In addition to this result, we analyze the result in each test by ANOVA. There was an interaction in the score of usual problem-posing test between experience of MONSAKUN and pre-posttest ($p=.03$). So, we analyzed simple effect. There was a significant difference in the score of posttest between experienced group and inexperienced group ($F(1, 36)=3.193, p=.008$). This result suggested that it is effective for the subjects to experience the learning by using MONSAKUN for improving their usual problem solving performance. Next, there was a significant difference in the score of extraneous problem solving test between experienced group and inexperienced group ($p=.04$), and effect size is medium ($|\eta^2|=0.10$). Also, there was a significant difference in the score between pretest and posttest ($p=.02$), and effect size is small ($|\eta^2|=0.02$). In addition to this analysis, we analyzed the correlation between the pretest score and the difference between posttest and posttest score. In this result, there are a negative correlation between them (Spearman's rank-correlation coefficient, $|rs|=.59, p=2.5E-06$). These results suggested that the lesson by using our learning environment promote the subjects to improve their problem structure, in particular, more effective to the subjects who have experienced MONSAKUN to comprehend the problem structure. MONSAKUN Touch 3 is more effective for the subjects who the score of extraneous problem solving test is lower particularly. Last, there was no significant difference in the number of posed problem between experienced and inexperienced group. But, there was a significant difference between pretest and posttest ($p=.005$), and effect size is medium ($|\eta^2|=0.07$). These results suggested that MONSAKUN is useful for the subjects to improve their problem-posing performance regardless of whether the subjects have experienced MONSAKUN.

Table 2: Result of Each Pretest and Posttest in experienced group (N=18) and inexperienced (N=20).

Test	Experience of MONSAKUN	Pretest		Posttest	
		M	SD	M	SD
Problem-posing	experienced	2.50	1.57	3.56	1.42
	inexperienced	2.10	1.45	2.7	1.52
Usual Problem solving	experienced	13.61	1.34	14.28	0.80
	inexperienced	13.30	1.52	12.75	2.05
Extraneous Problem Solving	experienced	10.83	2.14	11.38	0.76
	inexperienced	8.80	3.54	9.75	3.40

5. Conclusion

In this paper, we have described the learning environment for problem-posing in one-step multiplication or division arithmetic word problem and its practical use. In order to realize the learning environment, firstly, we have mentioned that three quantities and its relation define one-step multiplication or division word problem. These three quantities are called base quantity, proportion and compared quantity. Its relation expresses the story that is "Base quantity multiplied by proportion is compared quantity" and so on. At the second step, the problem-posing based on this problem structure and the diagnosis and feedback of posed problem are defined. The levels of assignment were designed so that the learner can judge the story means whether multiplication or division. After that, we have developed learning environment called MONSAKUN Touch 3 and MONSAKUN Analyzer. Lastly, an eleven lesson experimental use is reported. The results of brief analysis suggested that the third grade students who have learned by using MONSAKUN in the past time are improved their problem solving performance and sophisticated their acquired problem structure.

As our future works, we need to verify the quantity of the effect to high group by using MONSAKUN Touch 3. Furthermore, we should perform the practical use for problem-posing in one-step addition, subtraction, multiplication or division to fourth grade students of an elementary school continuously.

References

- E.A. Silver, J. CAI. (1996). An analysis of arithmetic problem posing by middle school students. *Journal for Research in Mathematics Education*, 27(5), 521-539.
- Greer, B. (1992). Multiplication and Division as Models of Situations. *Handbook of Research on Mathematics Teaching and Learning*, 276-295.
- Hirashima, T., Kurayama, M. (2011). Learning by Problem-Posing for Reverse-Thinking Problems, *Proc. of AIED 2011*, 123-130.
- Hirashima, T., Yokoyama, T. Okamoto, M. ,Takeuchi, A. (2007). Learning by Problem-Posing as Sentence-Integration and Experimental Use. *Proc. of AIED2007*, 254-261.
- Kintsch, W., Greeno, J.G. (1985). Understanding and Solving Word Arithmetic Problem. *Psychological Review*, 92(1), 109-129.
- Mayer, R. E. (1982). Memory for algebra story problem. *Journal of Educational Psychology*, 74, 199-216.
- Muth K.D. (1992). Extraneous information and extra steps in arithmetic word problems, *Contemporary educational psychology*. Vol. 17, pp.278-285.
- Nakano, A., Hirashima, T., Takeuchi, A. (1999). Problem-Making Practice to Master Solution-Methods in Intelligent Learning Environment. *Proc. of ICCE'99*, 891-898.
- Polya, G. (1945). *How to Solve It*. Princeton University Press.
- Vergnaud, G. (1983). Multiplicative Structures. *Acquisition of mathematics concepts and processes*, 127-174.
- Yamamoto, S., Kanbe, T., Yoshida, Y., Maeda, K., Hirashima, T. (2012). A Case Study of Learning by Problem-Posing in Introductory Phase of Arithmetic Word Problems. *Proc. of ICCE2012, Main Conference E-Book*, 25-32.
- Yamamoto, S., Takuya H., Kanbe, T., Yoshida, Y., Maeda, K., Hirashima, T. (2013). Interactive Environment for Learning by Problem-Posing of Arithmetic Word Problems Solved by One-step Multiplication, *Proc. of ICCE2013, Main Conference E-Book*, 51-60.

Question Generation Using WordNet

Nguyen-Think LE & Niels PINKWART
Humboldt-Universität zu Berlin, Germany
{nguyen-thinh.le, niels.pinkwart}@hu-berlin.de

Abstract: Discourse and argumentation are effective techniques for education not only in social domains but also in science domains. However, it is difficult for some teachers to stimulate an active discussion between students because several students might not be able to develop their arguments. In this paper, we propose to use WordNet as a semantic source in order to generate questions that are intended to stimulate students brainstorming and to help them develop arguments in an argumentation process. In a study, we demonstrate that the system-generated questions sound naturally as human-generated questions as measured by computer scientists.

Keywords: Question generation, WordNet, argumentation

1. Introduction

Studies have reported that deploying questions are effective for learning. Asking targeted, specific questions is useful for revealing knowledge gaps with novices, who are often unable to articulate their questions (Tenenbergh & Murphy, 2005). Other researchers used prompts as a kind of questions in order to encourage students to self-explain and demonstrated that prompts are a promising instructional feature to foster conceptual understanding (Berthold et al., 2011).

Argumentation is an important skill that is required in any situation, either in research or in daily life, and thus needs to be trained. In order to train students, usually, they are asked to discuss together about a given topic. That is, they need to develop arguments during the argumentation process. However, students may sometimes not proceed with their argumentation. In this paper, we propose to use questions in order to stimulate their brainstorming and the goal is that they use the posed questions to develop new arguments for a given discussion topic. How can questions that are semantically related to a given discussion topic be generated in order to help students develop further arguments?

In this paper, we introduce an approach to exploiting WordNet to generate questions which are related to a discussion topic and investigate the research question: *Do automatic system-generated questions appear as natural as human-generated questions?* This paper reports on results of an evaluation study that is intended to test the specified research question.

2. State of the Art of Question Generation for Educational Purposes

Traditionally, questions are generated from a text or from structured data and natural processing techniques are used to analyze a text and to construct a question. In the state of the art, Le and colleagues (Le et al., 2014) classified educational applications of automatic question generation into three classes according to their educational purposes: 1) knowledge/skills acquisition, 2) knowledge assessment, and 3) educational systems that use questions to provide tutorial dialogues.

Examples of the first class of educational applications of automatic question generation include the work of Kunichika et al. (2001) who extracted syntactic and semantic information from an original text and generated questions based on extracted information, the reading tutor of Mostow and Chen (2009), and the system G-Asks (Liu et al., 2012) for improving students' writing skills (e.g., citing sources to support arguments, presenting evidence in a persuasive manner). The second class of educational applications of question generation aims at assessing knowledge of students and includes the approach of Heilman and Smith (2010) for generating questions for assessing students' acquisition of factual knowledge from reading materials, the computer-aided environment for generating multiple-choice test items of Mitkov et al. (2006), and the REAP system of Brown et al (2005), intended to assess the student's understanding after reading a text. The third class of educational applications generates

questions to be employed in tutorial dialogues in a Socratic manner. Olney and colleagues (Olney et al., 2012) presented a method for generating questions for tutorial dialogues. This method extracts concept maps from textbooks in the domain of Biology, questions are constructed based on these concepts. Person and Graesser (2002) developed an intelligent tutoring system for the areas of computer literacy and Newtonian physics. Each topic contains a focal question, a set of good answers, and a set of anticipated bad answers. For the domain of Computer Science, Lane & VanLehn (2005) developed a tutor which is intended to help students develop pseudo-code solution to a given problem.

In the contrast to traditional approaches to generating questions using texts as an input, Jouault and Seta (2013) proposed to generate questions by querying semantic information from Wikipedia to facilitate learners' self-directed learning. Using this system, students in self-directed learning are asked to build a timeline of events of a history period with causal relationships between these events given an initial document. The student develops a concept map containing a chronology by selecting concepts and relationships between concepts from the given initial Wikipedia document to deepen their understandings. While the student creates a concept map, the system integrates the concept to its map and generates its own concept map by referring to semantic information of Wikipedia. The system's concept map is updated with every modification of the student and enriched with related concepts that can be extracted from Wikipedia. Thus, the system's concept map always contains more concepts than the student's map. Using these related concepts and their relationships, the system generates questions for the student to lead to a deeper understanding without forcing to follow a fixed path of learning.

We propose to use WordNet as a semantic source for generating questions that aim at stimulating the brainstorming of students during the process of argumentation. The approach to be presented is different from the work of Jouault and Seta in that we use natural language techniques to extract key concepts that serve as inputs to query semantic information from WordNet whereas Jouault and Seta focused on exploiting linked data technologies to extract semantic information.

3. Question Generation Approach

In this section, we describe conceptually how questions can be generated. A detailed description of this approach is referred to Le et al. (2014b). In order to illustrate the question generation approach, we will use the following example discussion topic that can be given to students in a discussion session:

“The catastrophe at the Fukushima power plant in Japan has shocked the world. After this accident, the Japanese and German governments announced that they are going to stop producing nuclear energy. Should we stop producing nuclear energy and develop renewable energy instead?”

The question generation approach consists of four steps: 1) analyzing a text structure and identifying key concepts, 2) generating questions using key concepts in a discussion topic, 3) generating questions using related concepts in WordNet, and 4) generating questions using example sentences in WordNet.

3.1 Analyzing text structure and identifying key concepts

In order to automatically recognize key concepts of a discussion topic, a natural language parser is used to analyze the grammatical structure of a sentence for its constituents, resulting in a parse tree showing their syntactic relation to each other. The language parser analyzes a text and identifies the category of each constituent, for instance: determiner, noun, or verb. Since nouns and noun phrases can be used as key concepts in a discussion topic, we select from the parsing results of a discussion topic the constituents which are tagged as nouns (NN) or noun phrases (NP). In our example discussion topic from above, the following noun phrases can serve as key concepts to generate questions: *catastrophe, Fukushima power plant, nuclear energy, renewable energy*.

3.2 Question Generation Using Key Concepts in a Discussion Topic

The extracted key concepts are helpful for generating questions. Yet, an issue that needs to be addressed next is to determine the types of questions to be generated. Several question taxonomies have been proposed by researchers in the area question generation. Among the existing question taxonomies, the

question taxonomy for tutoring proposed by Graesser and Person (1994) has been widely used. This taxonomy consists of 16 question categories: verification, disjunctive, concept completion, example, feature specification, quantification, definition, comparison, interpretation, causal antecedent, causal consequence, goal orientation, instrumental/procedural, enablement, expectation, and judgmental. The first 4 categories were classified as simple/shallow, 5-8 as intermediate and 9-16 as complex/deep questions. We apply this question taxonomy to define appropriate question templates for generating questions. For example, Table 1 defines some question templates for the classes “Definition” and “Feature/Property”, where X is a placeholder for a key concept extracted from a discussion topic. For example, the question templates of the class “Definition” can be filled with the noun phrase “nuclear energy” and result in the following questions: *What is **nuclear energy**? What do you have in mind when you think about **nuclear energy**? What does **nuclear energy** remind you of?*

Table 1: Question Templates proposed for question generation.

Type	Question
Definition	What is <X>?
	What do you have in mind when you think about <X>?
	What does <X> remind you of?
Feature/Property	What are the properties of <X>?
	What are the (opposite)-problems of <X>?

3.3 Question Generation Using Related Concepts in WordNet

In order to generate questions that are related to key concepts of a discussion (but which do not literally contain these concepts), sources of semantic information can be exploited (e.g., Wikipedia, Wiktionary, or WordNet). Currently, we deploy WordNet (Miller, 1995) because it is suitable to find related concepts for a discussion topic. WordNet is an online lexical reference system for English. Each noun, verb, or adjective represents a lexical concept and has a relation link to hyponyms which represent related concepts. In addition, for most words WordNet provides example sentences which can be used for generating questions. For example, if we input the word “energy” into WordNet, an example sentence like “energy can take a wide variety of forms” for this word is available. If we look for some hyponyms for this word, WordNet provides a list of direct hyponyms and a list of full hyponyms. The list of direct hyponyms provides concepts which are directly related to the word being searched. For example, the direct hyponyms of “energy” as listed by WordNet include “activation energy”, “alternative energy”, “atomic energy”, “binding energy”, “chemical energy”, and more. The list of full hyponyms contains a hierarchy of hyponyms which represent direct and indirect related concepts of the word being searched. One of the advantages of WordNet is that it provides accurate information (e.g., hyponyms) and grammatically correct example sentences. For this reason, we exploit hyponyms provided by WordNet to generate questions which are relevant and related to a discussion topic. Placeholders in question templates (cf. Table 1) can be filled with appropriate hyponym values for generating questions. For example, the noun “energy” exists in the discussion topic, so that WordNet suggests “activation energy” as a hyponym. The question templates of the class “Definition” can then be used to generate questions such as: *What is **activation energy**? What do you have in mind when you think about **activation energy**? What does **activation energy** remind you of?*

3.4 Question Generation Using Example Sentences in WordNet

In addition to using hyponyms, we propose to make use of example sentences to generate questions. There are existing tools which convert texts into questions. For example, ARK [13] is a syntax-based tool for generating questions from English sentences or phrases. The system operates on syntactic tree structures and defines transformation rules to generate questions. For example, a direct hyponym of the key concept “catastrophe” is “tsunami” for which there is an example sentence “a colossal tsunami destroyed the Minoan civilization in minutes”. Using ARK, the example sentence can be converted into questions: “*What destroyed the Minoan civilization in minutes?*”, “*When did a colossal tsunami destroy the Minoan civilization?*”, “*What did a colossal tsunami destroy in minutes?*”

4. Evaluation

The goal of our evaluation is to determine whether automatically generated questions are perceived as as natural as human generated questions. Our study design is similar to the Turing test that requires humans to decide whether they are interacting with an actual computer program or with a human via computer mediation. The study being presented in this paper is a variation of the Turing test: we wanted to know whether automatically generated questions can be distinguished from human generated questions easily by human raters. Human raters we employed in this study were Computer Scientists (including Professors, Senior Researchers, and Phd. candidates).

4.1 Design

In the first evaluation phase, we asked eight human experts from the research communities of computer based argumentation and question generation research to generate questions for three discussion topics. We received 54 questions for Topic 1, 47 questions for Topic 2, and 40 questions for Topic 3. These questions are referred to as human generated questions in this paper.

Topic 1: *The catastrophe at the Fukushima power plant in Japan has shocked the world. After this accident, the Japanese and German governments announced that they are going to stop producing nuclear energy. Should we stop producing nuclear energy and develop renewable energy instead?*

Topic2: *Recently, although the International Monetary Fund announced that growth in most advanced and emerging economies was accelerating as expected. Nevertheless, deflation fears occur and increase in Europe and the US. Should we have fear of deflation?*

Topic 3: *“In recent years, the European Central Bank (ECB) responded to Europe's debt crisis by flooding banks with cheap money...ECB President has reduced the main interest rate to its lowest level in history, taking it from 0.5 to 0.25 percent” . How should we invest our money?*

For each discussion topic, the system generated several hundred questions (e.g., 844 questions for Topic 1), because for each discussion topic several key concepts are extracted, and each key concept has a set of hyponyms that are queried from WordNet. For each key concept and each hyponym, fourteen questions have been generated based on defined question templates (see examples in Table 1). Since this set of generated questions was too big for a human expert evaluation, we selected a small subset of these questions manually so that the proportion between the automatic generated questions and the human generated questions was about 1:3. There were two reasons for this proportion. First, if there had been too many automatically generated questions, this could have influenced the “overall picture” of human generated questions. Second, we needed to make a trade-off between having enough (both human-generated and system-generated) questions for evaluation and considering a moderate workload for human raters. The numbers of automatically generated questions and of human generated questions are shown in Table 2.

Then, we mixed human generated questions with automatic generated questions and asked human raters to decide for each question from the mixed set whether they believed it was generated by a computer system or by a human expert. Note that these human raters were not the same human experts who generated the questions and did not know about the proportion between human-generated and system-generated questions. Specifically, the following question was answered by human raters: *Is that an automatic system-generated question? (Yes/No)*

Table 2: Number of questions generated by human experts and by the system for evaluation.

	Topic 1: No. of questions	Topic2: No. of questions	Topic 3: No. of questions
Human-generated	54	47	40
System-generated	16	15	13
Total	70	62	53

4.2 Results

We use the balanced F-score to evaluate the ratings of humans. This score is calculated based on precision and recall using the following formula:

$$F = \frac{2 * precision * recall}{precision + recall}$$

The precision for a class is the number of true positives (i.e., the number of system-generated questions correctly labeled as system-generated) divided by the total number of elements labeled as positive (i.e., labeled as system-generated), while the recall for a class is the number of true positives divided by the total number of elements that actually are positive (i.e., that are system-generated). If the F-score is high (close to 1), it shows that the system-generated questions are easy to distinguish from human-generated questions, and vice versa.

Table 3: Classification result of two raters on authorship of questions.

	SGQ predicted by Rater 1 (% of total)	HGQ predicted by Rater 1 (% of total)	SGQ predicted by Rater 2 (% of total)	HGQ predicted by Rater 2 (% of total)	Total
Topic 1					
System-GQ	12 (75%)	4 (25%)	13 (81%)	3 (19%)	16
Human-GQ	45 (83%)	9 (17%)	22 (41%)	32 (59%)	54
Topic 2					
System-GQ	13 (87%)	2 (13%)	15 (100%)	0	15
Human-GQ	24 (51%)	23 (49%)	28 (60%)	19 (40%)	47
Topic 3					
System-GQ	10 (77%)	3 (23%)	12 (92%)	1 (8%)	13
Human-GQ	27 (67%)	13 (33%)	30 (75%)	10 (25%)	40

Table 3 shows how two human raters rated the mixed set of questions in the context of Topic 1. A high number (75%) of system-generated questions (SGQ) and 17% of human-generated questions (HGQ) have been correctly identified by this rater, resulting in a low F-score of 0.329 (Recall=0.211, Precision=0.75) that indicates that it was difficult for the rater to identify system-generated questions. This is because the first rater decided wrongly on 83% of the human-generated questions. The second rater, however, achieved a medium F-score of value 0.51 (Recall=0.371, Precision=0.813) that is higher than of the first rater, indicating that also this rater had some difficulties in distinguishing between human-generated and system-generated questions. Interestingly, although both raters had difficulties in distinguishing between human-generated and system-generated questions, the agreement between the two was poor in addition (Kappa=0.086).

In the context of Topic 2, the first rater achieved an F-score of 0.5 (Recall=0.351, Precision=0.867) The second rater showed a similar tendency with an F-score of 0.517 (Recall=0.349, Precision=1). The Kappa value for their agreement was 0.233, which can be considered as fair.

In the context of Topic 3, one question (“What is cheap money?”) was generated by a human expert and by the system in identical form. This was left out from analysis (however, this question was classified as a system-generated question by both human raters). Specifically, the first rater achieved a low F-score of 0.4 (Recall=0.27, Precision=0.769). This can be explained by the fact that the first rater classified 67% of human-generated questions as generated by the system. The second rater achieved a similarly low F-score of 0.436 (Recall=0.286, Precision=0.923). Similar to the case of Topic 2, the agreement between the first and the second raters in the context of Topic 3 was fair (Kappa=0.263).

In summary, we have learned that for all raters and all three topics it was difficult to identify system-generated questions within the set of mixed questions (F-scores between 0.329 and 0.517). This is an indication that the system-generated questions appeared as natural as the human-generated questions to these raters. The agreement between raters was poor or fair, further strengthening this argument (there was little agreement on questions that seemed clearly human-generated or clearly system-generated).

5. Conclusions, Discussion and Future Work

In this paper, we have presented an approach to generating questions using WordNet as a source of semantic information. The goal is using generated questions to stimulate students brainstorming and thus, participate more actively in argumentation. We have conducted a pilot study comparing system-generated questions with questions that have been generated manually by researchers of the argumentation and question generation research communities. The study results show that the difference between human-generated and system-generated questions is not large: human raters could not tell the difference easily. However, it needs to be noted that we had to select manually a small number of questions from a huge amount (several hundreds) of system-generated questions. At present, we do not use an automatic algorithm for this task. We also think about limiting the number of system-generated questions, because if a student requests questions for developing arguments and s/he receives such a huge amount of questions, this can impact on the argumentation process negatively. As future work, we will develop criteria to limit the number of system-generated questions and evaluate the system-generated questions with respect to the quality and usefulness.

References

- Berthold, K., Röder, H., Knörzer, D., Kessler, W., Renkl, A. (2011). The double-edged effects of explanation prompts. *Computers in Human Behavior* 27(1), 69–75.
- Brown, J., Frishkoff, G., & Eskenazi, M. (2005). Automatic question generation for vocabulary assessment. *Proceedings of Human Language Technology Conference and Empirical Methods in NLP*, 819-826.
- Graesser, A. C. & Person, N. K. (1994). Question Asking during Tutoring. *American Educational Research Journal*, 31(1), 104 –137.
- Graesser, A. C., Rus, V., D'Mello, S. K., & Jackson, G. T. (2008). AutoTutor: Learning through natural language dialogue that adapts to the cognitive and affective states of the learner. In: Robinson & Schraw (Eds.), *Recent innovations in educational technology that facilitate student learning*, 95-125, Information Age Publishing.
- Heilman, M. & Smith, N. A. (2009). Question generation via over-generating transformations and ranking. *Report CMU-LTI-09-013*, Language Technologies Institute, School of Computer Science, CMU.
- Jouault, C., & Seta, K. (2013). Building a Semantic Open Learning Space with Adaptive Question Generation Support. *Proceedings of the 21st International Conference on Computers in Education*, 41-50.
- Kunichika, H., Katayama, T., Hirashima, T. & Takeuchi, A. (2001). Automated Question Generation Methods for Intelligent English Learning Systems and its Evaluation. *Proceedings of the International Conference on Computers in Education*, 1117-1124.
- Lane, H. C. & Vanlehn, K. (2005). Teaching the tacit knowledge of programming to novices with natural language tutoring. *Journal Computer Science Education*, 15, 183–201.
- Le, N.-T., Kojiri, T. & Pinkwart, N. (2014). Automatic Question Generation for Educational Applications – The State of Art. *Advanced Computational Methods for Knowledge Engineering*, Vol. 282, 325-338.
- Le, N.-T., Nguyen, N.-P., Seta, K. & Pinkwart, N. (2014). Automatic question generation for supporting argumentation. *Vietnam Journal of Computer Science* 1(2), 117-127.
- Liu, M., Calvo, R.A., & Rus, V. (2012). G-Asks: An Intelligent Automatic Question Generation System for Academic Writing Support. *Dialogue and Discourse* 3 (2), 101-124.
- Miller, G. A. (1995). WordNet: A lexical database. In: Communications of the ACM, 38(11), 39-41.
- Mitkov, R., Ha, L. A., & Karamanis, N. (2006) A computer-aided environment for generating multiple-choice test items. *Journal Natural Language Engineering* 12 (2): 177–194. Cambridge University Press.
- Mostow, J. & Chen, W. (2009). Generating instruction automatically for the reading strategy of self-questioning. *Proceeding of the Conference on Artificial Intelligence in Education*, 465-472.
- Olney, A.M., Graesser, A., & Person, N.K. (2012) Question Generation from Concept Maps. *Dialogue and Discourse* 3 (2), 75–99.
- Person, N. K., & Graesser, A. C. (2002). Human or Computer? AutoTutor in a Bystander Turing Test. *Proceedings of the 6th International Conference on Intelligent Tutoring Systems*, Stefano A. Cerri, Guy Gouardères, and Fábio Paraguaçu (Eds.), Springer-Verlag, 821-830.
- Tenenberg, J. & Murphy, L. (2005). Knowing What I Know: An Investigation of Undergraduate Knowledge and Self-Knowledge of Data Structures. *Journal Computer Science Education*, 15(4), 297-315.
- Turing, A. M. (1950). Computing machinery and intelligence. In E. A. Feigenbaum & J. Feldman (Eds.) *Computers and thought*. New York: McGraw-Hill.

Understanding differences of eye movements patterns while reading musical scores between instructors and learners to design learner-centered teaching strategies

Katsuko T. NAKAHIRA^{a*} & Muneo KITAJIMA^a

^a*Nagaoka University of Technology, Japan*

*katsuko@vos.nagaokaut.ac.jp

Abstract: While learning instruments playing, one engages in the following mental and motor activities; reading notes in a musical score, retrieving relevant information from long-term memory concerning how to play the notes, moving relevant body parts, and verifying his/her performance against the expected sound. The learner is required to coordinate these activities in the learning process. This paper assumes that how the process of coordination is carried out should depend on the degree of matching between the learner's skill and the musical score which should appear in the process of reading; visually encoding the to-be-played notes and verifying the sound from the instrument he/she has just played. This paper proposes a method for objectively measuring the degree of matching by using eye movements data while reading a musical score with hearing notes.

Keywords: Education, Eye-Tracking

1. Introduction

Learning instrument playing is one of popular activities that many people do in their lives. One learns instrument playing to become a skillful performer, to enjoy themselves as hobby, to be licensed as a musical teacher, etc. Musical scores are the materials these people would use while learning, and their contents would have a large impact on the course of learning. The learner would be willing to use a musical score that he/she estimates it matches his/her purpose of instrument learning, on the other hand, he/she would not use such a music score that is too difficult for him/her to play. This paper proposes a method for objectively measuring the degree of matching by using eye movements data while one is reading a musical score with hearing notes with some empirical data.

There are many works that deal with eye movements while reading music. Wristen (2005) argued that sight-reading is an integral part of the experience for all musicians, and argued the direction of its ability. In the review, sight-reading task divided into two large phases: preparation and performance, and performance. Especially, performance needs a number of cognitive demands. At least, to recognize the score, the basic elements for sight-reading is rhythm, melody, harmony, and context. After getting the knowledge of the elements, Lehmann and Ericsson (n.d.) showed to decipher a score at sight reading, the musicians have to recognize musical patterns, generate a large-scale performance, plan to govern performance of the piece as a whole, and learn to anticipate how the music continues. With the idea, several researches tried to describe the difference of sight-reading skills for music learners. For example, Kopiez and Galley (2002) tried to compare features of eye movements in musicians to a non-musician. Thus, the relation of eye movement, sight-reading, and the music learners' skills is going to explain. If the idea will be able to be realized practically, we can estimate easily the learners' ability for sight-reading, and expansively. For the perspective, we can easily imagine the application of the method to e-Learning. Before applying, we need to consider how to include the technique for e-Learning. In general, almost instructors thought that training instruments playing skill is incongruous with e-Learning. But during the several years, the causes of incongruence partly have been improved with some researches with the analysis of the relation between training elements and human knowledge or feeling.

Nakahira and Kitajima (2013) proposed an educational design for piano playing and singing that is capable of transferring skill related to not only explicit knowledge but also implicit knowledge. In order to explore specifications of such an educational design, we adopted a methodology called Cognitive Chrono-Ethnography (CCE), which was successfully applied to understand people's daily behavior, for studying how trainees interact with and utilize a proposed educational design in real educational settings, which would eventually lead to an appropriate specification of student-centered educational design for piano playing and singing skill transfer. They set the design consisted of the following three elements: (i) having the trainee watch a video of the model performance for the purpose of building mental image of the performance goal, (ii) having the trainee mimic the model performance while referring to guidance comments added on the musical score, and video-record the performance, and (iii) having the trainee submit the video and critically review his/her own performance. Using this, they designed student-centered design for education in skill transfer. Through the research, they suggested to identify critical parameters and understand the trainees' behaviors while they used the student-centered educational design for piano playing and singing skill transfer.

2. Methodology

While a learner is practicing instrumental playing, he/she has to engage in the following four processes;

1. reads the musical score and associate it with his/her body movements,
2. sends signal from his/her brain to his/her body parts,
3. moves his/her body for playing,
4. checks accuracy of his/her playing.

In this paper, we focused on the first process of reading musical score and the fourth process of checking accuracy of their playing

2.1 Reading Musical Scores

In the following, we describe in detail the processes involved in reading musical scores.

First, the learner gets notes from the musical score. In this process, he/she visually acquires each note as a code of sound through his/her eyes, and the visual information is sent to his/her brain. The signal of note information is used to retrieve a set of information associated with the note from long-term memory, including the sound pitch, the position of instrument to strike a note, and so on. After retrieving the relevant information, the learner moves his/her body to hit the note. Upon hitting it, the instrument makes some sound. The learner recognizes the sound he/she has just made as a signal, and compares it with the information having been retrieved from long-term memory. If there is no mismatch, he/she recognizes the hitting was correctly carried out, and the learner proceeds to get a next note. If not, he/she recognizes the hitting is incorrectly performed, and the learner retries to play the correct note. We can identify two critical processes that should affect the performance of learners; The first is a visual process which is the process of getting information necessary for hitting the note, including such information as posture of fingers, how to move fingers, sound to be heard, etc. The second is the accuracy check, which is done by comparing the pitch of sound he/she has just played and the corresponding information retrieved from long-term memory. This is essentially the process of matching the auditory image that has been put in working memory by playing the note with the one having been loaded in working memory prior to playing it.

The first process of visual information processing and the second process of mental process of auditory information matching have to be carried out in parallel and in synchronous with the action of instrument playing. We assume that the degree of difficulty in carrying out these processes coherently should appear in the eye movements of the learner. If the learner feels the difficulty level of the musical score just matches his/her skill level, he/she would smoothly get the note information from the musical score. As a result, his/her eye movements would show coherent patterns, which would be observed while one is reading sentences in his/her favorite books. On the other hand, however, if he/she feels the musical score too easy or too difficult, he/she may feel uncomfortable about getting the note

information in his/her favorite page. His/her eye movements would show incoherent patterns, i.e., abrupt leaps, abnormally long fixations at specific places, etc.

2.2 A Model of Eye Movements While Reading a Musical Score

Figure 1 shows a model of musical score reading. Suppose a situation in which a musical score is placed in front of the learner. We are interested in the two datasets; one is the series of eye-fixations on the musical score, and the other is the series of note-playing events. Both datasets can be regarded as a function of time, and therefore we can investigate the mutual relationships by arranging them in the time dimension and trying to discover patterns that would be associated with the degree of matching of the musical score and the learner's skill level. In the figure, the horizontal line shows the eye position in the horizontal dimension, and the vertical line shows the elapsed time since the onset of the first note, which has a linear relationship with the time course of note-playing events. We denote the time course of note-playing events as a set $Q_{\text{note-playing}}$ (sound sequences in Figure 1) and eye fixation events as a set P_{fixation} (pattern A – C in Figure 1):

$$\begin{aligned} Q_{\text{note-playing}} &= \{ (x(t_j), y(t_j)) \mid j = 1, 2, \dots \}, \\ P_{\text{fixation}} &= \{ (\xi(t_k), \eta(t_k)) \mid k = 1, 2, \dots \} \end{aligned}$$

where $(x(t_j), y(t_j))$ represents the (x, y) coordinate of the j -th musical score image, and $(\xi(t_k), \eta(t_k))$ represents the (ξ, η) coordinate of the k -th fixation recorded at $t = t_k$. Using these descriptions, we assume three possible patterns in the relationships between P_{fixation} and $Q_{\text{note-playing}}$;

- **Pattern A:** a large set of (ξ, η) coordinates in $Q_{\text{note-playing}}$ corresponds with the one in P_{fixation} , meaning that the learner reads the musical score as a large chunk while he/she hears the stream of sounds of notes being played with the instrument,
- **Pattern B:** a smaller set of (ξ, η) coordinates in $Q_{\text{note-playing}}$ corresponds with the one in P_{fixation} , meaning that the learner reads less frequently than Pattern A learner does,
- **Pattern C:** there is little correspondence between (ξ, η) coordinates in the set P_{fixation} and (x, y) coordinates in the set $Q_{\text{note-playing}}$.

Using the three patterns, we can estimate the learner's status of instrument playing skill. When a learner has sufficient ability to read musical scores and hear the stream of sounds of notes in parallel, the learner would show the behavior, so called "shadow hearing" of the musical score. In this case, he is treated as a subset of $Q_{\text{note-playing}}$, that corresponds to Pattern A. A skilled instrumental player would show a stream of eye fixations similar to P_{fixation} even if there is no sounds of notes to hear. $Q_{\text{note-playing}}$, when exits, might be used as cues for keeping timing, but it would not be necessary for those who can do "shadow hearing." Less skilled players would show less coherent relationship between $Q_{\text{note-playing}}$

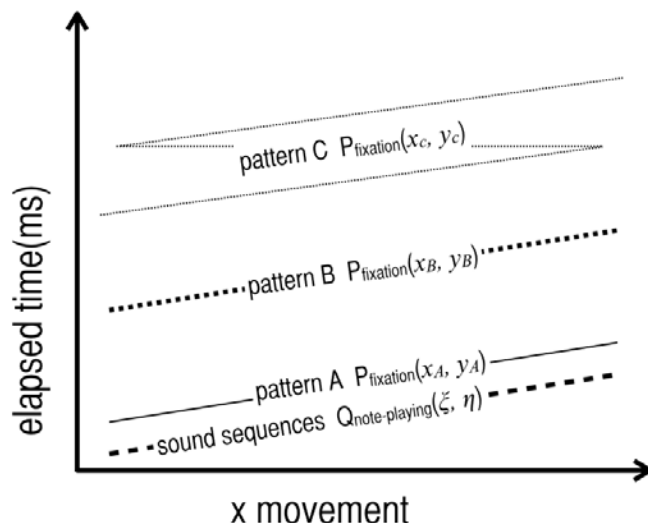

Figure 1. A model of musical score reading.

and P_{fixation} than the one shown by the skilled players as described above. We assume that there should be two cases that would be distinguishable in terms of the relationship between $Q_{\text{note-playing}}$ and P_{fixation} . The first case is characterized by unstable P_{fixation} without musical sounds, but stable P_{fixation} with $Q_{\text{note-playing}}$; in other words, musical sounds are inevitable for them to exhibit consistent eye movement patterns. Musical sounds help the learner search the appropriate notes from learner's long-term memory. We assume that this case corresponds to Pattern B. The second case is characterized by a reverse relationship between $Q_{\text{note-playing}}$ and P_{fixation} , namely,

stable P_{fixation} without musical sounds, but unstable P_{fixation} with $Q_{\text{note-playing}}$. In this case, the introduction of musical sounds would cause extra cognitive burden on the learners that make difficult for them to search notes from learners' long-term memory. We assume that this case corresponds to Pattern C

3. Experiment

Applying the methodology, we make a hypothesis for eye tracking of reading music and the trajectory. If the learners groups' ability is almost similar, the learners' reading music split some patterns;

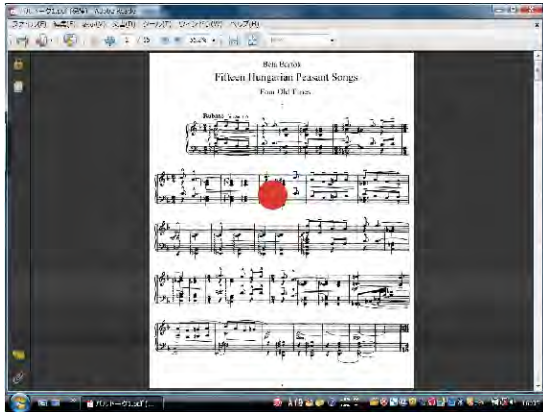

Figure 2. A screenshot for the experiment. A large red circle displayed on the monitor indicates the recorded participant's gaze point. The musical score was displayed in the entire area of the monitor.

- (1) independently with or without musical sound, the learners' eye tracking pattern has no difference,
- (2) dependently with or without musical sound, the learners' eye tracking pattern has some difference, dividing into learners' ability of reading musics.

To test the hypothesis, we conducted an experiment. At the experiment, we focus the ability of collaboration between visually and auditory. Due to this, we adopt the model performance for musical sound which means the musical sound does not stop due to the players' mistake. If the learner achieve a mastery of the musical score, he/she can match $Q_{\text{note-playing}}$ pattern with their P_{fixation} , if not, he/she cannot match. And the P_{fixation} pattern will change whether the experiment include with or without musical sound. We chose participants, expected to have uniform learners'

level, from a pre-school teacher education institution which has a class for basic piano/singing course. Fourteen students and two instructors participated in the experiment. All students had basic piano playing skills. We prepared a one page musical score whose level was at the middle class for piano instrument, including some chordal notes. Although the score had five lines, we used first two lines for acquiring eye tracking data in order to avoid recording errors. It included nine bars with about 30 note heads. Each musical score was displayed on a 22 inch LCD monitor, with a resolution of 1024 x 768 pixels. The distance between the monitor and an participant was about 30cm. We used a Tobii Eye Tracker to record participants' eye movement with sampling rate of 50Hz. Figure 2 shows a screenshot from the experiment. The experiment was conducted according to the following flow:

First, the experimenter explained the outline of the experiment, then instructed the important points that the participant was expected to follow consisting of the following four items (the participant is indicated as "you" in the following instruction);

- (1) When you read the musical score, please keep your head in the region about 30cm from the monitor's surface;
- (2) There are two conditions. One is "read musical score without sound" condition and the other is "read musical score with sound" condition.
- (3) When you are in the "read musical score without sound" condition, please imagine the melody from the musical score, and try to synchronize the position of notes you read and the sound pitches you image;
- (4) When you are in the "read musical score with sound" condition, please synchronize the sound pitches you hear and the position of the note heads you read from the musical score;

After calibrating the Tobii eye tracker, the experimenter presented the musical score on the monitor with full screen, followed by sending a starting sign to the participant. Between the two conditions, a short break was given to the participant.

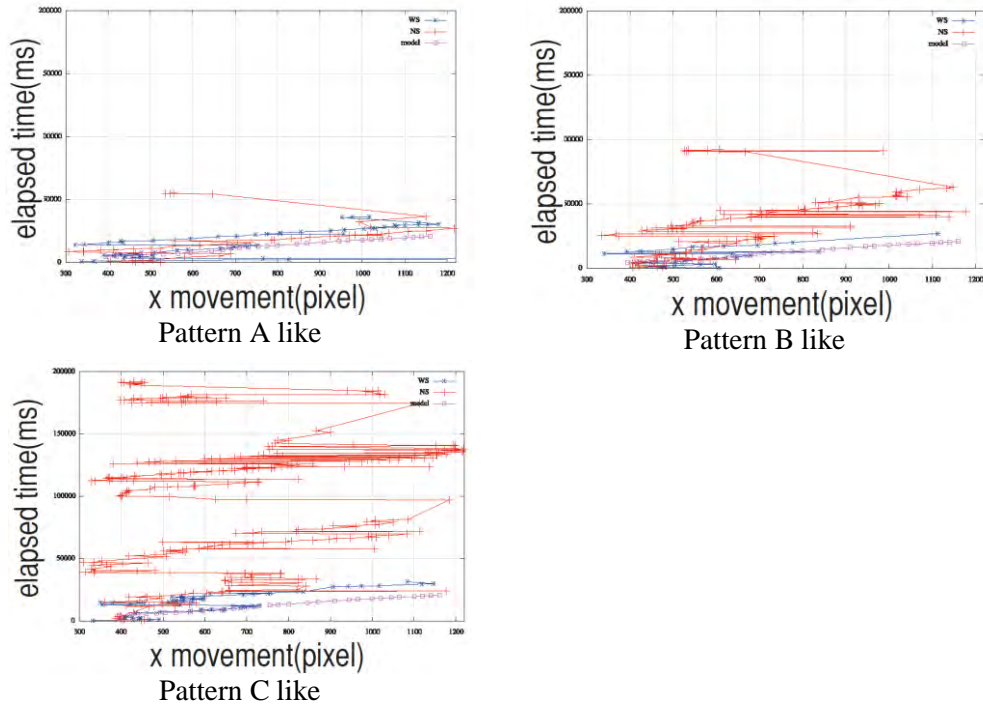

Figure 3. Typical trajectories of participants' eye tracking patterns. \square represents $Q_{\text{note-playing}}$, $+$ represents P_{fixation} for reading soundless musical score, $*$ represents P_{fixation} with sound reading music.

4. Analysis

After the experiment, we analyzed the recorded eye movement data. We use first two lines for analysis. At first, we tried to get rid of noises from the data from the i -th participant's P_{fixation} . In this research, we make smoothing the dataset P_{fixation} , namely calculated average for $\xi_i(t_k)$ and $\eta_i(t_k)$ coordinate per each 10 points. We regard the smoothed P_{fixation} as point of gazes. Next step of the analysis is to calculate stationary points for smoothed P_{fixation} . In this analysis, we set the human central area of vision θ_c as 2 degree (≈ 23 pixels). If the i th participant's two adjacent gaze points distance is longer than θ_c , we judged that the stationary point had moved. If the distance is shorter than θ_c , we regarded that the stationary point had not moved. Through this process, we can derive the i -th participant's stationary points series.

Figure 3 shows the typical trajectories of participants' eye tracking patterns. Square symbol represents $Q_{\text{note-playing}}$, plus symbol represents P_{fixation} for reading soundless musical score, asterisk symbol represents P_{fixation} with sound reading music. From the figures, we find the learners have several difference of $Q_{\text{note-playing}}$ and P_{fixation} with/without sound reading music. From the figures, we find almost learners' trajectories of participants' eye tracking will be distinguished pattern A, B, or C.

5. Discussion

Through the analysis, we considered the learners' types. There are some possibilities for selecting musical score to play appropriate for their playing skill levels. When people want to play a musical instrument, they need to engage in elemental-level training to treat instrument. In the process, learners cannot select the etude or melody music target, because they have least skills for playing instrument. But when they move their skill level status from the elemental level to middle levels, they have possibilities of selecting musical scores due to their variety of playing skills. Though their selections could become diverse, sometimes they tend to choose such musical scores just only too easy or too

difficult. In the case of hobby training, there would be no problem in specific selections. But if the learners need or want to improve their playing instrument skills, they have to select musical scores at a challenging level.

6. Conclusion and Future Works

In this paper, we proposed the method for estimating learners' skills to fill in the gaps of their skills and the requirement skill from musical score. Focusing on the processes of reading musical score and of checking accuracy of their playing, we set the hypothesis about the relation between eye movement, auditory checking accuracy for pitch, and reading music. For checking the relation, we set an experiment of eye tracking for reading music, with or without musical sound. We found that the learners state could be divided in four categories by using the features measured by dh and dv , showing differences between sound time sequences and eye positions in the horizontal dimension with or without musical sound. With these categories, we proposed a method of easy estimation for learners' skill and musical scores which fits learners' skill for future

Acknowledgements

The study described in this paper has been partially funded by the Scientific Research Expense Foundation C Representative: Muneo Kitajima (24531274).

References

- Kopiez, R., & Galley, N. (2002). The musicians' glance: A pilot study comparing eye movement parameters in musicians and non-musicians. In *Proceedings of the 7th international conference on music perception and cognition* (pp. 683–686). Adelaide: Causal Productions.
- Lehmann, A. C., & Ericsson, K. A. (n.d.). Performance without preparation: Structure and acquisition of expert accompanying and sight-reading performance. *Psychomusicology*, 15, 1-29.
- Nakahira, K. T., & Kitajima, M. (2013). Development of a student centered educational design for piano playing and singing skills. In A. S. Mashat, H. M. Fardoun, & J. A. Gallud (Eds.), *Proceedings of IDEE 2013 - 2nd international workshop on interaction design in educational environments* (p. 146-152).
- San Agustin, J., Skovsgaard, H., Hansen, J. P., & Hansen, D. W. (2009). Low-cost gaze interaction: Ready to deliver the promises. In *Chi '09 extended abstracts on human factors in computing systems* (pp. 4453–4458). New York, NY, USA: ACM.
- San Agustin, J., Skovsgaard, H., Mollenbach, E., Barret, M., Tall, M., Hansen, D.W., et al. (2010). Evaluation of a lowcost open-source gaze tracker. In *Proceedings of the 2010 symposium on eye-tracking research 38; applications* (pp. 77–80). New York, NY, USA: ACM.
- Wristen, B. (2005). Cognition and motor execution in piano sight-reading: A review of literature. *Applications of Research in Music Education*, 24(1), 44-56.

A Framework of Generating Explanation for Conceptual Understanding based on 'Semantics of Constraints'

Tomoya HORIGUCHI^{a*}, Takahito TOUMOTO^b & Tsukasa HIRASHIMA^c

^a *Graduate School of Maritime Sciences, Kobe University, Japan*

^b *Faculty of Engineering Division II, Tokyo University of Science, Japan*

^c *Department of Information Engineering, Hiroshima University, Japan*

* horiguti@maritime.kobe-u.ac.jp

Abstract: A framework for indexing problems is proposed, based on which explanation generation and problem sequencing for conceptual understanding in science can be automatized. It helps student learn how to make appropriate models to solve problems and prevents them from superficially read the solution of a worked example and apply it wrongly to others. The results of a preliminary experiment is also described in which the explanations generated based on the framework promoted subjects' conceptual understanding in mechanics.

Keywords: science education, problem practice, worked example, explanation generation, semantics of constraints

1. Introduction

In problem practice in science (e.g., physics), most students fail to acquire the ability to make an appropriate model for a given task. An expert can model not only the behavior of a system in question, but also she/he can do so in various tasks. Such expertise includes identifying the structure of the system in question and the applicable principles/laws for making the necessary and sufficient model. It also includes understanding how/why a model changes when the task is changed. We call such ability 'conceptual understanding' of the domain.

In order to reach such understanding, students need to learn (1) to infer the structural features of problems from the superficial features, and (2) to apply appropriate principles/laws to structural features to make models. For assisting students, it is insufficient to explain how each problem is solved. It must be explicitly explained why the principles/laws are applicable to the given situation (surface structure) and what physical meaning (physical structure) they imply. It is also important to explain how the model changes when the situation (problem) is changed. Furthermore, it would promote such learning to provide students with an appropriately designed and sequenced set of problems (Scheiter and Gerjets, 2003; VanLehn and van de Sande, 2009).

In this paper, we propose a framework for indexing problems, based on which explanation generation and problem sequencing mentioned above can be automatized. In our framework (called 'Semantics of Constraints: SOC'), making a model in physics is regarded as a process in which various constraints (applied principles/laws and modeling assumptions) are imposed on the target system and its behavior. A model is regarded as the set of constraints.

After introducing the SOC framework, we show the method for generating SOC-based explanations. The results of preliminary experiment are also described which proved the usefulness of our framework.

2. Semantics of Constraints and Explanation Generation

Given a physics problem, one makes a model of the target system which is necessary and sufficient for answering the query by embodying an appropriate part of the domain theory. Domain theory consists of a set of propositions each of which describes a principle/law, its applicable condition and resulting constraint(s) on the attribute(s) of the system. Constraints by embodied principles/laws are called the 'constraints of physical phenomenon (PPCs).' In making a model, various modeling assumptions are set. Modeling assumptions define the structure/behavioral range of a system and physical phenomena to be considered. Since an embodied PPC is valid under some modeling

assumptions (applicable conditions), a PPC always has its corresponding modeling assumptions. Constraints by modeling assumptions are called the 'constraints of modeling assumptions (MACs).' Boundary condition of a system is given by the 'constraints of boundary condition (BCCs).' They define the influence from the outside of the system. Making the influence which can't/needn't be calculated with a model means defining the boundary of the model (i.e., what physical processes are considered/ignored). That is, a BCC always has its corresponding modeling assumptions. In our framework, a model is the union of PPCs, MACs and BCCs. Especially, though MACs are usually implicit, they are essential for explaining models because MACs gives the validity of PPCs and BCCs. When MACs are changed, PPCs and BCCs also qualitatively change. In order to make a model correctly, therefore, it is necessary to understand the physical meaning of the constraints based on modeling assumptions (i.e., why an assumption is set and what role it plays). More detail about SOC is discussed in Horiguchi and Hirashima (2009), and Horiguchi, Hirashima and Forbus (2012).

A model-making process (i.e., solution) is described as the procedure in which principles/laws are applied in turn to the given situations (represented with MACs and BCCs) to yield new consequences (represented with PPCs). The explanations about a problem and the difference between problems are generated based on such a representation and the comparison between representations. Such explanations are called 'SOC-based explanations.'

3. Preliminary Experiment

We conducted an experiment to evaluate the usefulness of our framework. The purpose was to examine whether the SOC-based explanation promotes students' conceptual understanding, that is, whether their representation of problems was improved and they became able to solve various types of problems by using correct models.

Subjects: 15 graduates and under graduates whose majors are engineering participated.

Procedure: First, subjects were given problem set 1 (15 problems in mechanics called PS-1) and asked to group the problems into some categories based on some kind of 'similarity' they suppose, then asked to label each category they made (called 'categorization task 1'). Then, they were asked to solve 8 problems in PS-1 (called 'pre-test'). After a week, the subjects were divided into two groups: the 'control group' (7 subjects) and the 'experimental group' (8 subjects). The average scores of both groups in pre-test were made equivalent. The subjects in control group were given the *usual explanation* about the solutions of 11 problems in PS-1 (which explains the calculation of the required physical amount from the given ones) to learn. The subjects in experimental group were given the SOC-based explanation about the same problems as the usual explanation to learn. Then, by using problem set 2 (other 15 problems in mechanics called PS-2), 'categorization task 2' was conducted in the same way as above. Finally, subjects were asked to solve 8 problems in PS-2 (called 'post-test').

Measure: The quality of the representation of problems was measured with the categories, their 'frequencies' (number of problems accounted for) and the time required in each categorization task. The ability to solve various types of problems was measured with the scores in each test. The effect of learning with usual/SOC-based explanation was measured with the comparison of the results of two categorization tasks and pre-/post-tests. The superiority of SOC-based explanation to usual explanation was measured with the differences of improvement of categorization and problem-solving between experimental and control groups.

Results: The categories made by subjects and their frequencies in categorization task 1 are shown in table 1. Most of the subjects categorized the problems based on the similarity of their superficial features, such as the components of the system (e.g., inclined plane), the figures of motion (e.g., circular motion). Additionally, all subjects finished the task within 10 minutes. The results of categorization task 2 are shown in table 2 (control group) and table 3 (experimental group). Many subjects of control group still categorized the problems based on the similarity of their superficial features, while many subjects of experimental group became to categorize the problems based on the similarity of their structural features, that is, the dominant principles/laws of problems (e.g., Newton's second law, balance of forces, conservation of energy). Additionally, all subjects of control group finished the task within 10 minutes again, while the subjects of experimental group required from 25 to 35 minutes. These results suggest the learning with SOC-based explanation promoted representing problems based on their structural features rather than their superficial features (the increase of the time required suggests the subjects of experimental group inferred the physical structure from surface structure). The average scores in pre- and post-tests are shown in figure 1 (in both tests, full marks were 52). In pre-test, there was no significant difference of average scores between groups (control group: 36.0 and experimental group: 33.6, t-test $p > .10$). In post-test, though there was also no significant difference of average scores between groups (control group: 42.7 and experimental group: 47.6, t-test: $p > .10$), the increase of average score of experimental group was larger than that of

control group. This result suggests the learning with SOC-based explanation promoted the ability to solve various types of problems, that is, to make appropriate models regardless of their superficial features. These results suggest that SOC-based explanation about the solution of problems and their differences can assist students in reaching conceptual understanding.

Table 1: Categories in task-1

	Number of subjects using category labels (N ₁ =15)	Average size of category (N ₂ =15)	Number of problems accounted for (N=N ₁ ×N ₂ =225)	Number of problems wrongly accounted for (N ^w =225)	Number of problems correctly accounted for (N ^c =N-N ^w)
Springs	12	3.1	37	2	35
Free fall etc.	9	4.1	37	2	35
Collision	12	2.0	24	0	24
Circular motion	12	1.9	23	1	22
Acceleration	3	5.7	17	1	16
Strings	7	2.0	14	0	14
Inclined planes	5	2.2	11	0	11
Balance	5	2.4	12	4	8
Object only	1	5.0	5	0	5
Friction	3	1.7	5	0	5
Second law	2	2.5	5	2	3
Pulleys	1	2.0	2	0	2
Balance of energies	1	4.0	4	2	2
Motion of weight	1	2.0	2	0	2

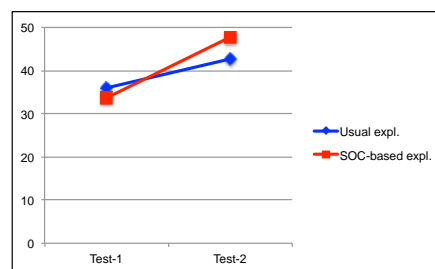

Figure 1. Average scores of tests.

Table 2: Categories in task-2 (usual)

	Number of subjects using category labels (N ₁ =7)	Average size of category (N ₂ =15)	Number of problems accounted for (N=N ₁ ×N ₂ =105)	Number of problems wrongly accounted for (N ^w =105)	Number of problems correctly accounted for (N ^c =N-N ^w)
Springs	4	4.5	18	0	18
Inclined planes	4	3.3	13	0	13
Balance of forces	3	3.7	11	0	11
Conservation of energy	3	6.0	18	9	9
Second law	3	3.7	11	2	9
Pulley and string	2	3.5	7	0	7
Circular motion	4	1.5	6	0	6
Pendulum	3	1.7	5	0	5
Simple harmonic motion	2	2.0	4	1	3
Collision	2	1.0	2	0	2

Table 3: Categories in task-2 (SOC)

	Number of subjects using category labels (N ₁ =8)	Average size of category (N ₂ =15)	Number of problems accounted for (N=N ₁ ×N ₂ =120)	Number of problems wrongly accounted for (N ^w =120)	Number of problems correctly accounted for (N ^c =N-N ^w)
Balance of forces	7	4.4	31	5	26
Second law	7	3.6	25	1	24
Conservation of energy	8	4.1	33	12	21
Linear accelerated motion	3	3.3	10	2	8
Conservation of momentum	3	1.3	4	1	3
Acceleration	1	3	3	0	3
Springs	1	3	3	0	3
Pulleys	1	3	3	0	3
Simple harmonic motion and period	2	1	2	0	2
String and tension	1	2	2	0	2
Time	1	2	2	0	2

4. Conclusion

We showed the explanations generated with the SOC framework could promote conceptual understanding through a preliminary experiment. SOC-based explanation generator can provide a basic function for designing various instructional methods (e.g., a detailed explanation is gradually simplified (scaffolding-fading), a sequence of problems is given which promotes spontaneous induction).

References

- Horiguchi, T. & Hirashima, T. (2009). Intelligent Authoring of 'Graph of Microworlds' for Adaptive Learning with Microworlds based on Compositional Modeling, *Proc. of AIED2009*, pp.207-214.
- Horiguchi, T., Hirashima, T. & Forbus, K.D. (2012). A Model-Building Learning Environment with Error-based Simulation, *Proc. of QR2012*.
- Scheiter, K. & Gerjets, P. (2003). Sequence Effects in Solving Knowledge-Rich Problems: The Ambiguous Role of Surface Similarities, *Proc. of CogSci2003*, 1035-1040.
- VanLehn, K. & van de Sande, B. (2009). Acquiring conceptual expertise from modeling: The case of elementary physics, In Ericsson, K. A. (Ed.) *The Development of Professional Performance: Toward Measurement of Expert Performance and Design of Optimal Learning Environments* (Cambridge University Press), 356-378.

A Program Transformation Tool for Visualizing Control Structure in Graphical Representations

Chih-Yueh CHOU^{ac*}, Pin-Cheng, LIAO^a, K. Robert LAI^{ac}, & Zhi-Hong CHEN^{bc}

^a*Department of Computer Engineering and Science, Yuan Ze University, Taiwan*

^b*Department of Information Communication, Yuan Ze University, Taiwan*

^c*Innovation Center for Big Data and Digital Convergence, Yuan Ze University, Taiwan*

*cychou@saturn.yzu.edu.tw

Abstract: In this paper, we describe a work-in-progress research to develop a program control structure visualization tool for transforming student programs into graphical representations of control structure, including sequences, selections, and iterations. The tool can be used for assisting novice students in debugging their programs by checking whether the transformed control structure of their programs is consistent with their program plans. In addition, the graphical representation of student programs can be compared to that of a model program to detect errors in program plans.

Keywords: Computer assisted programming learning, Program transformation, Program visualization, Control structure, Debugging.

1. Introduction

Programming involves many complex processes and knowledge, such as designing a program plan, generating program code to realize the program plan, and debugging and fixing the program if errors exist, thus students, particularly novice programmers, may encounter great difficulties (Robin, Rountree, and Rountree, 2003). Teachers and teaching assistants are helpful to diagnose the errors in student programs and to help students fix errors, but it causes heavy workload for teachers and teaching assistants. Some computer automated assessment systems have been developed to assist in assessing student programs (Ala-Mutka, 2005). These systems provide helpful feedbacks by employing two assessment approaches: dynamic assessment and static assessment. Dynamic assessment compiles and executes programs with several test input data to assess functional correctness and efficiency. Static assessment analyzes program code to assess coding style, design, and errors. Program code analysis is complex and difficult because program codes might have many semantic-preserving variations, such as different variable names, different function names, and different statement orders. To improve program code analysis, researchers proposed transforming program codes into semantic graphical representations based on control dependence and data dependence (Li, Pan, Zhang, and Chen, 2010; Wang, Su, Wang, and Ma, 2007; Xu and Chee, 2003). However, these studies hide semantic graphical representations inside the systems and do not visualize graphical representations to assist students in debugging their programs.

Students may have errors in planning and coding, but students might lack of awareness of errors in their programs. Syntax errors in coding can be detected by a program compiler, but it is difficult for students to detect errors in planning and semantic errors in coding. Studies of visualizing control structure of programs revealed that the program visualization, which maps programs to graphical representations, improved students' program comprehensibility and learning (Ben-Ari et al. 2011; Hendrix, Cross, and Maghsoodloo, 2002). In addition, Brusilovsky (1993) suggested that program visualization could be used as a debugging tool for novices. This study presents a work-in-progress prototype system to visualize the control structure of student programs in graphical representations for assisting novice students in debugging their programs.

2. The Prototype System and Possible Applications

A prototype system, named ProgramVisualAid, was developed to transform student programs into graphical representations of control structure. A structured program consists of three control structures: sequence, selection, and iteration. Figure 1 displays the graphical representations of a student program, which computes whether a year is a leap year or not. Each node denotes a code and each link indicates a control flow. The representations reveal that the program has three selection structures to check whether the year can be divisible by 4, 100, and 400. The third selection structure is inside the second selection structure and the second selection structure is inside the first selection structure.

The visualization tool can be used as a debugging tool for students. First, students can check whether the transformed control structures of their programs match their program plans or not. If student programs have semantic errors in coding program plans, the transformed control structure will be inconsistent with the plan. For instance, the third selection structure in Figure 1 has two control flow links to separately link two “cout” codes. If the “else” code in the 16th line is missed, the graphical representation of the third selection structure will have a control flow link to sequentially link two “cout” codes. Students’ awareness of the inconsistency leads students to fix the error.

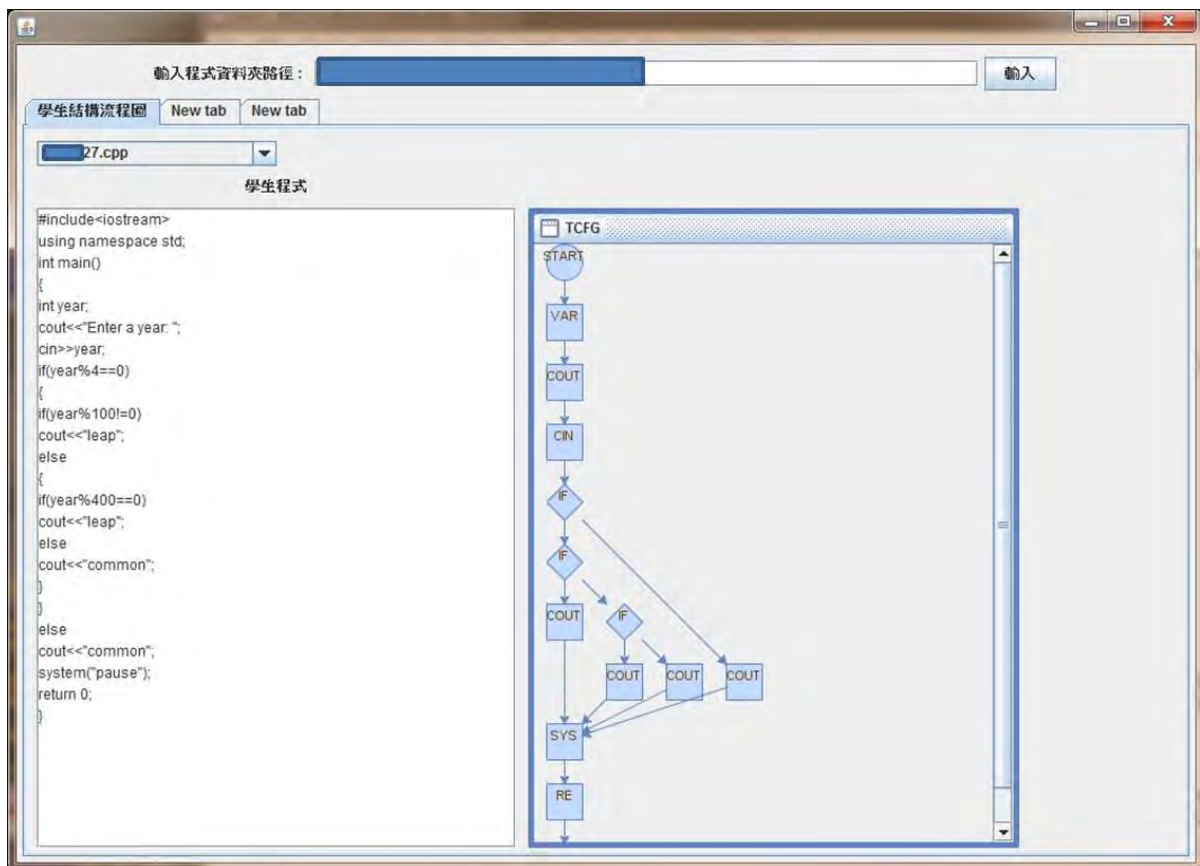

Figure 1. Control Structure Visualization of a Correct Leap Year Program.

Second, graphical representations of student programs can be compared to that of a model program to detect errors in planning. For instance, if the program in Figure 1 is a model program and the program in Figure 2 is a student program, the comparison of graphical representations of these two programs reveals that the student program lacks of a selection structure to check whether the year is divisible by 400 or not. We are implementing a comparison mechanism of comparing graphical representations of two programs to find out the difference of control structures. The difference between a student program and a model program might indicate errors of the student program plan. However, a problem might be solved by many variations of programs. We are also implementing dynamic assessment mechanism, which compiles and executes programs with several test input data to assess functional correctness, to find out more possible model programs. The system will compare a student program to all model programs and adopt the comparison result with the most similar model program.

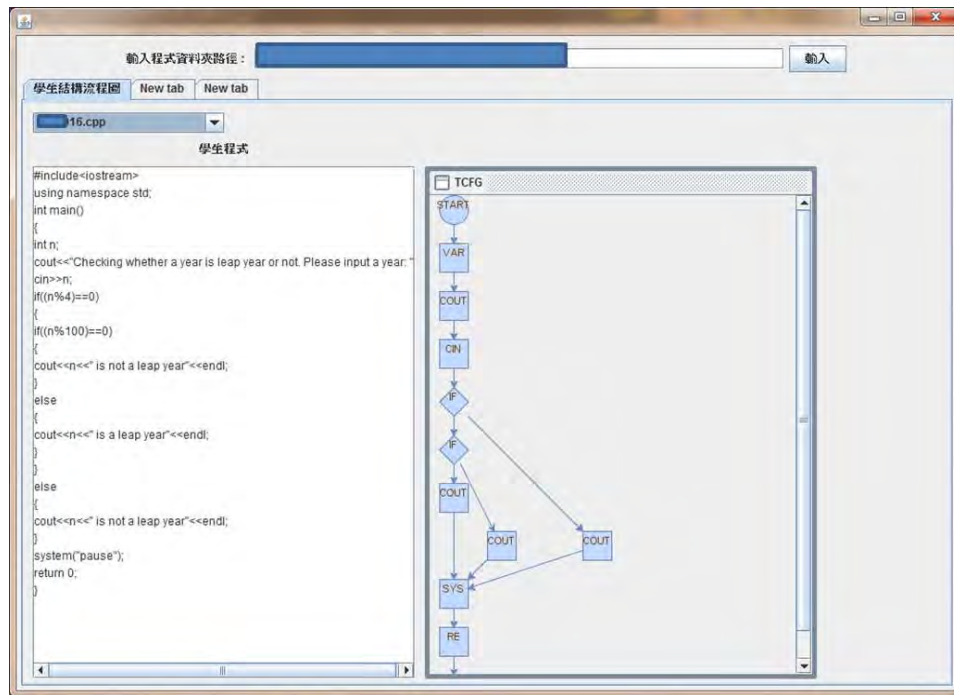

Figure 2. Control Structure Visualization of a Wrong Leap Year Program.

3. Summary

This paper presents a work-in-progress research to develop a program visualization tool for transforming student programs into graphical representations of control structure. The tool can be used for assisting students in debugging their programs by checking whether the transformed control structure of their programs is consistent with their program plans. The graphical representations of student programs can be compared to that of a model program to detect errors in program plans. We are developing comparison and more analysis mechanisms to improve the visualization tool.

Acknowledgements

The authors would like to thank the support of the Ministry of Science and Technology, Taiwan (NSC 100-2511-S-155 -004 -MY3 and MOST 103-2511-S-155 -003)

References

- Ala-Mutka, K. M. (2005) A survey of automated assessment approaches for programming assignments, *Computer Science Education*, 15 (2), pp. 83-102.
- Ben-Ari, M., Bednarik, R., Ben-Bassat Levy, R., Ebel, G., Moreno, A., Myller, N., & Sutinen, E. (2011). A decade of research and development on program animation: The Jeliot experience. *Journal of Visual Languages & Computing*, 22(5), pp. 375-384.
- Brusilovsky, P. (1993). Program visualization as a debugging tool for novices. In *INTERACT'93 and CHI'93 Conference Companion on Human Factors in Computing Systems*, pp. 29-30.
- Hendrix, D., Cross, J. H., & Maghsoodloo, S. (2002). The effectiveness of control structure diagrams in source code comprehension activities. *Software Engineering, IEEE Transactions on*, 28(5), 463-477.
- Li, J. Pan, W., Zhang, R. & Chen, F. (2010). Design and implementation of semantic matching based automatic scoring system for C programming language, In *Proceedings of Edutainment 2010*, LNCS 6249, pp. 247 – 257.
- Robin, A., Rountree, J., and Rountree, N. (2003). Learning and teaching programming: A review and discussion, *Computer Science Education*, 13, no. 2, 137-172.
- Wang, T., Su, X., Wang, Y. & Ma, P. (2007). Semantic similarity-based grading of student programs, *Information and Software Technology*, 49, 99-107.
- Xu, S. & Chee, Y.S. (2003) Transformation-based diagnosis of student programs for programming tutoring systems. *IEEE Transaction on Software Engineering*, pp. 360 – 384.

A Students' Mutual Evaluation Method for their Reports using PageRank Algorithm

Yuanyuan WANG^{a*}, Yukiko KAWAI^a, Setsuko MIYAMOTO^b & Kazutoshi SUMIYA^b

^a*Faculty of Computer Science and Engineering, Kyoto Sangyo University, Japan*

^b*School of Human Science and Environment, University of Hyogo, Japan*

*yuanw@cc.kyoto-su.ac.jp

Abstract: Nowadays, mutual evaluation in education is an available method that students in the learning community use to evaluate each other. The method calculates scores of students' reports by considering who evaluates those reports. In this paper, we propose a student's mutual evaluation method using the PageRank algorithm, an appropriate evaluation method that helps teachers to easily understand whose report is the best from the students' viewpoints. In particular, we perform students' mutual evaluation based on a groupware by utilizing a "Like" function in a course practice. As a result, it was able to not only provide an overall rating from the students' sum of votes but also, by considering who voted, to promote the reliability of the students as evaluators for their mutual evaluation.

Keywords: Mutual Evaluation, PageRank Algorithm, Groupware

1. Introduction and Motivation

Currently, teachers need to evaluate several student reports after their lectures. Teachers are challenged by not only evaluating reports on multiple topics, but also by a multitude of student viewpoints. Therefore, student reports need to be evaluated from several viewpoints. A great deal of time and effort is required for a fair and multi-faceted evaluation of the reports.

In this paper, we introduce a mutual evaluation method to enable students to evaluate their reports using information technology. In this method, students perform report evaluation instead of the teachers, which produces a positive effect in the students towards education. Therefore, we develop a students' mutual evaluation method using the PageRank algorithm, which provides a graph illustrating which reports received "Like" votes and from whom. During a course, the following steps are followed: 1) Writing reports after lectures, 2) evaluating reports written by other students and voting with a "like" button using the online groupware system; and 3) Receiving votes for their own reports." Therefore, the students obtain the perspective of an evaluator; which promotes their ability of both writing and evaluating reports.

The next section describes a PageRank algorithm and the proposed students' mutual evaluation method. In Section 3, we summarize the results of the students' mutual evaluation method in a course practice. Finally, in Section 4, we conclude this paper with suggestions for future works.

2. Students' Mutual Evaluation Method using PageRank Algorithm

2.1 PageRank Algorithm

The PageRank algorithm is used by Google Search to rank websites in their search engine results. It is a method of measuring the popularity of webpages. According to website ranking, the PageRank algorithm counts the number and quality of links to a page to determine an estimate of the popularity of the website. A link structure of the Web is shown in Figure 1(1).

- Back link: A page that links to other pages is called the back link of the other pages (e.g., A is a back link of D), which indicates that the back link recommends (is related to) the other pages, and they are important for the back link.

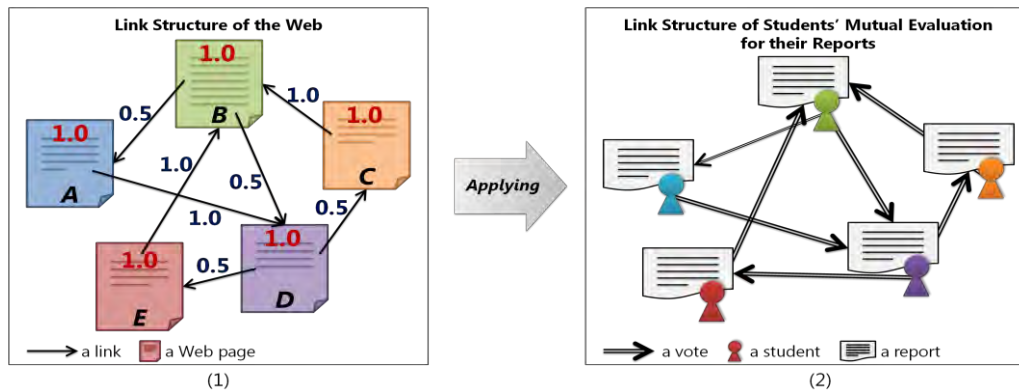

Figure 1. A link structure of the Web applied to Students' Mutual Evaluation

- Forward link: A page that is linked from other pages (back links), is a forward link of the back links (e.g., A is a forward link of B). Then, a page (forward link) has high importance if the sum of the importance of its back links is high.

We calculated the popularity of each page using PageRank as follows (see Figure 1 (1)):

$$PR(u) = (1-d) + d (PR(v_1)/N(v_1) + \dots + PR(v_x)/N(v_x)) \quad (1)$$

- u : a Web page, i.e., A, B, C, D, or E
- v_1, \dots, v_x : the set of u 's back links, i.e., D's back links, v_1 : A, v_2 : B
- $N(v_x)$: the number of forward links of page v_x , i.e., $N(B)=2$
- d : a damping factor adjusts the derived value downward. Various studies have tested different damping factors, but it is generally assumed that the damping factor is approximately set as 0.85

Initially, the importance of each page is 1.0, if there are multiple forward links of a page, the importance distributes through each link evenly, e.g., if B has two forward links, A and D, the importance of each link to A and D becomes 0.5. Therefore, B is the most important page in the link structure, since $PR(B)$ has the highest value.

2.2 Students' Mutual Evaluation for their Reports

As depicted in Figure 1, (1) and (2) have the same link structure, and therefore, a back link can be considered as a vote from one student for another student's report. Therefore, in this paper, we are challenged to attempt a students' mutual evaluation of their reports using the PageRank algorithm. In our previous work, we built a system that provides a ranking of Web pages based on the PageRank algorithm by evaluating users who browse the Web pages. In this study, in order to evaluate the students' reports based on their mutual evaluation; we focused on the students who vote on reports.

We conduct students' reports by using a online groupware application; the student can post their reports at anytime and from anywhere in a given period, i.e., after a lecture and before the next lecture. Students can vote on the others' reports by pressing a "Like" button, when they think the report is good. It can reduce the students' burden of evaluating others' reports without specific points.

Using the mutual evaluation method based on PageRank, 1) a report of a student who votes for other students' reports produces a better report himself and 2) a report with many votes raises the reliability of its author's opinion when he casts his own votes. Thus, teachers can easily understand whose report is the best from the students' viewpoints, and we believe that this method can lead to an appropriate evaluation method in education in the future.

3. Results of Students' Mutual Evaluation

In this section, we present our findings from the results of the students' mutual evaluation in a course practice. This is a course of Applied Informatics, which consists of 10 lectures on different topics, and 23 students. Using the "Like" function as a vote through a online groupware, 1) we calculated the score of each report based on the sum of the number of "Like" from students; 2) we calculated the score of each report using the number of "Like" by employing a PageRank algorithm, and normalized the score between 0–10.0.

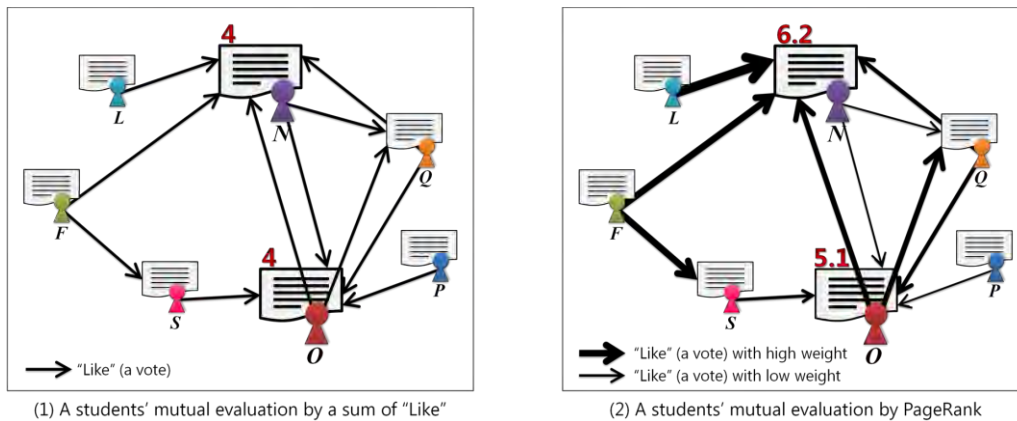

Figure 2. A link structure of the Web applied to Students' Mutual Evaluation

As a result, we determined that the difference of the score of the same report between 1) and 2). As depicted in Figure 2, a report of a student *N* gained four "Likes" from students *F*, *L*, *O*, *Q*, and a report of a student *O* gained four "Like" from students *N*, *P*, *Q*, *S*. The sum of the number of "Like" for the report of *N* and the report of *O* are identical, i.e., 4 (see Figure 2 (1)). However, the score of the report of *N* was 6.2 and the score of the report of *O* was 5.1; they were different due to different weight based on the PageRank, which considers the quality of the evaluators (a thick arrow denotes a high weight) (see Figure 2 (2)). In general, we know that teachers have a higher level of understanding, and their evaluation of student reports is reliable. Therefore, we considered that mutual evaluation becomes more meaningful when using PageRank, since the most reliable votes came from the highest quality students.

4. Conclusions

In this paper, we proposed a group of students' mutual evaluation method for their reports using the PageRank algorithm. In a course practice, students performed a mutual evaluation for their reports by voting for good reports using a "Like" function through an online groupware application. Therefore, it is not only a sum of votes for evaluating the students' reports, but also considering who votes on the reports. It enabled the teachers and the students to understand the criteria for a good report in the education area, and it can lead to a new method of review by mutual evaluation.

In the future, we need to measure inter-rater reliability of our proposed students' mutual evaluation based on the PageRank algorithm by analyzing the correlations between teachers' evaluation and the students' mutual evaluation.

Acknowledgements

This research was supported in part by Strategic Information and Communications R&D Promotion Programme (SCOPE), the Ministry of Internal Affairs and Communications of Japan, and a Grant-in-Aid for Scientific Research (B)(2) 26280042 from the Ministry of Education, Culture, Sports, Science, and Technology of Japan.

References

- Brin, S., & Page, L. (1998). The Anatomy of a Large-scale Hypertextual Web Search Engine. *Computer Networks and ISDN Systems*, 107-117.
- Shiraishi, Y., Zhang, J., Kawai, Y., & Akiyama, T. (2012). Simultaneous Realization of Page-centric Communication and Search. *Proceedings of the 21st ACM International Conference on Information and Knowledge Management (CIKM'12)*, 2719-2721.

An Ontology to Model E-learning Tools, Events and Experts for their Use in Specific Contexts

Juan M. SANTOS GAGO, Rubén MÍGUEZ PÉREZ, Manuel J. FERNÁNDEZ IGLESIAS, Agustín CAÑAS, Manuel CAEIRO RODRIGUEZ, Luis ANIDO RIFÓN

Department of Telematics Engineering, University of Vigo, Spain
*lanido@det.uvigo.es

Abstract: With the popularization of online repositories and content management systems, digital resources available to organize educational activities proliferate. Digital resources include many different possibilities besides content, like events, people, or hardware devices and software applications. We propose a conceptualization of the educational domain by means of an ontology aimed to comprehensively classify educational resources. This ontology may serve as the foundation of complex knowledge-based systems to assist teachers in the categorization, selection and retrieval of the most suitable resources for any educational activity in any educational scenario they wish to design and implement.

Keywords: Educational resources, semantic modeling, ontologies, knowledge engineering

1. Introduction

In the context of information science, an ontology is a formal, explicit specification of a shared conceptualization (Gruber, 1995). Ontology construction is one of the tasks associated to semantic modeling, which in turn is aimed to collect the implicit knowledge about the domain (i.e., educational resources). The semantic model will serve as a terminological foundation to explicitly describe, in a way that software applications can process, all the information elements involved. In our case, an ontology for educational resources would provide a shared vocabulary to model the type of educational resources and associated concepts, their properties and relations. With it, we will describe, categorize and classify educational resources, and will provide support for smart tools and personalized services to assist teachers to select the best resources according to the activities they wish to implement.

Once the conceptualization is completed, it has to be encoded in a language for defining ontologies and semantic rules. This encoding is necessary to use the developed semantic model with existing inference engines. We have to encode the ontologic model using a Description Logic-based language (e.g. OWL (McGuinness & van Harmelen, 2004) and the knowledge captured through logic rules using a language supporting Horn-like rules (e.g. SWRL or RIF). In our case, Protégé (Knublauch et al., 2005) has been identified as the most convenient ontology construction tool due to its flexibility versatility, simplicity and availability. A complete version of the ontology in OWL is available at <http://itec.det.uvigo.es/itec/ontology/itec.rdf>, and an ontology navigator including descriptions of all entities can be accessed at <http://itec.det.uvigo.es/itec/ontology/>.

2. An Ontology for Educational Resources

We identified three fundamental information groups, namely people, events, and tools. Persons are considered as resources that can be utilized in a classroom to provide added value to the learning process. Besides the teacher, students may have available a rich pool of experts in several areas to provide advice and support. According to this new vision, where persons are also considered resources available to configure learning processes, people characterization goes beyond state-of-the-art people descriptions, and must include all skills, expertise and context about an individual (e.g. fluency in a given language, degree of knowledge of a particular subject, communication tools at his/her disposal, affiliation, etc.).

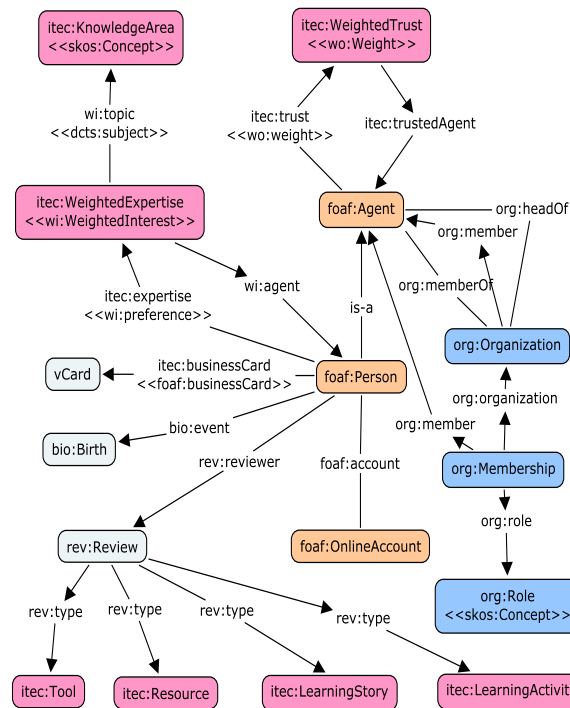

Figure 1. Excerpt of People Conceptualization.

Events should also be considered as relevant resources for the planning of learning activities in any comprehensive conceptualization of educational resources,. An event is a planned activity where participants from several organizations discuss ideas. Workshops, seminars, conferences and virtual meetings are examples of events that may support novel learning activities to improve the educational practice in schools. Event conceptualization should be targeted to model the most relevant features of events, like the type of participants, venue, relevant dates, audience, or specific tools needed to participate.

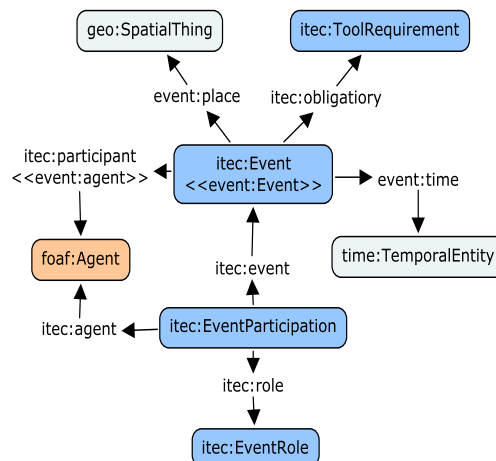

Figure 2. Excerpt of Event Conceptualization.

A key aspect of the actual implementation of learning activities is their technical feasibility, that is, to find out whether a learning activity can be performed in a given school taking into account its functional requirements and the hardware and software tools available there. Thus, the ontology should characterize the set of technological tools available in a school, that is, its technical setting, together with the distinct features of these tools (e.g. technical specifications, functionalities, supported languages, etc.).

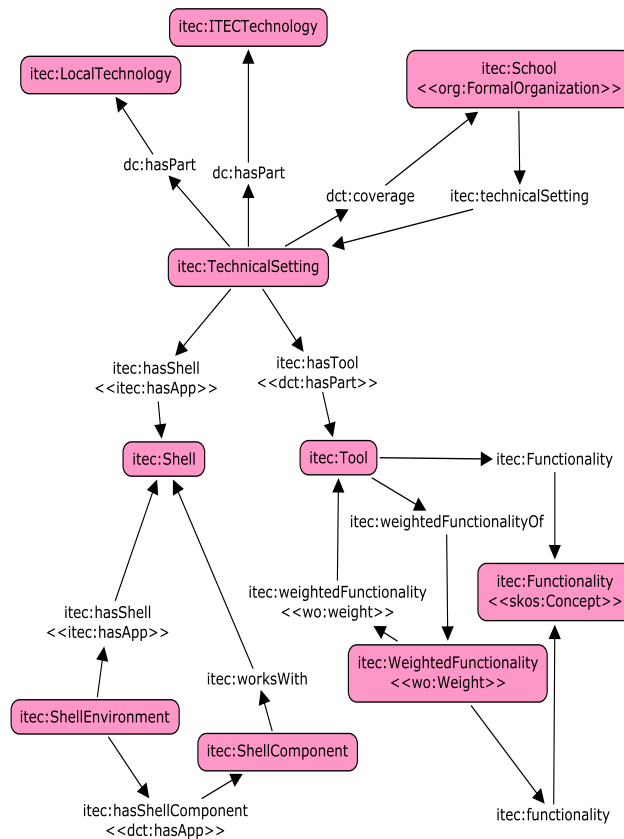

Figure 3. Excerpt of Tool Conceptualization.

3. Conclusion

Experts confirmed that most of the ontology does collect concepts and relations from the real world, providing a positive evaluation. However, some elements were identified that were deemed unnecessary for most real world educational scenarios. Several elements (*Trust*, *Expertise*, and the related measurement factors *WeightedTrust* and *WeightedExpertise*) were identified as candidates for removal because they were not considered as relevant. Besides, the data needed for these elements is hard to obtain. Finally, some experts posed some questions on the actual source of some of these pieces of information. Anyway, they were very specific issues that will be assessed once first tests with final users and real working scenarios take place.

Acknowledgements

This work presented on this article is partially supported by the European Commission's FP7 program – project iTEC: innovative Technologies for an Engaging Classroom (Grant nr. 257566) and the Spanish Ministry of Science and Innovation under grant *Methodologies, Architectures and Standards for adaptive and accessible e-learning (Adapt2Learn)* (TIN2010-21735-C02-01).

The content of this paper is the sole responsibility of its authors and it does not represent the opinion of the European Commission or the Spanish Ministry of Science and Innovation, which are not responsible of any use that might be made of the information contained herein.

References

- Gruber, T. R. (1995). Toward principles for the design of ontologies used for knowledge sharing. *Int.J.Hum.-Comput.Stud.*, 43(5-6), 907-928.
- Knublauch, H., Horridge, M., Musen, M. A., Rector, A. L., Stevens, R., Drummond, N., and Wang, H. (2005). The protege OWL experience. *OWL: Experiences and Directions Workshop*, p. 188
- McGuinness, D. L., & van Harmelen, F. (2009). OWL web ontology language overview. Retrieved 04/05, 2014, from <http://www.w3.org/TR/owl-features/>

Capturing Learning Attitudes through Presentation Design Activities

Kazuhisa SETA^{a*} Yuki TANIGUCHI^a and Mitsuru IKEDA^b

^a*Graduate School of Science, Osaka Prefecture University, Japan*

^b*School of Knowledge Science, JAIST, Japan*

*seta@mi.s.osakafu-u.ac.jp

Abstract: This paper describes a unique learning system that cultivates a positive attitude toward learning through presentation design activities. Learners are assigned two tasks: a declarative knowledge task, and a presentation task that involves selecting slides to create a presentation from among a set of slides that is provided. The slides have been prepared so that some of the slides are relevant and support the theme of the presentation while others are redundant or may even contain wrong information. A learner model is presented that captures the attitudes of subjects toward learning as they perform these tasks.

Keywords: Meta-Cognition, Presentation Design, Learner Attitudes, Learner Modeling

1. Introduction

Our previous study described an approach in which learners are given the task of preparing presentation materials about a particular topic that they have already understood (Seta and Ikeda 2011). We found that by providing a stimulation from the system that prompts learners to reflect back on own learning processes and to acquire domain-specific learning strategies, they achieved (i) tightening of criteria for evaluating own learning processes, (ii) a collaborative meta-learning communications as a way of focusing not on the discussion on attractive appearance of presentation but on ideal learning processes, and (iii) livelier reading between the lines activity touching on things not explicitly mentioned in textbooks.

The learning objective set in this study through presentation design activity is to be aware of the importance of deep understanding, and not mere shallow understanding of a topic in order to produce superior presentations. To achieve this objective, we have developed a learner model to capture their learning attitudes based on which learning-support system prompts learners' awareness on their own learning attitudes by enhancing reflection upon learning activities in pursuing presentation design activity.

2. Meta-learning Scheme through Presentation: Slide Selection Approach

Here we basically adopt the meta-learning scheme proposed by Seta et al.. A major difference between the previous study and the approach we adopt here is that, when learners deal with the task of compiling presentation materials, the instructor has pre-edited the slides and loaded them in the system in advance. In other words, the presentation design task does not require the subjects to actually produce the slides, but merely to select from among slides that have been previously prepared, and put them in proper sequence. Learners are faced with three subtasks as they work through the slide design task:

- (2-1) Learners monitor and reveal their own knowledge of the topic described in each slide offered by the system and declare their own knowledge state by selecting from the following three categories: "understand," "do not understand," and "slide is wrong."
- (2-2) Learners formulate a learning plan, and organize their presentations as they proceed with the task by selecting (or not selecting) the offered slides and putting them into order.

- (2-3) Learners receive guidance messages provided by the system and reflect upon their learning.

Note that slides loaded into the system include not only slides with correct information, but also slides that are plain wrong and slides lacking any important content for learning about the target domain. Moreover, theoretical back ground of the approach is The Knowledge Monitoring Assessment (KMA), developed by Tobias and Everson, is a well-known instrument for assessing metacognitive monitoring capabilities (Tobias and Everson, 2000). The KMA has students perform two types of problems.

- (1) A question is presented, and the learners have to declare whether they can answer correctly or incorrectly.
- (2) Candidate answers are presented, and learners choose the appropriate answer.

Type (1) is a comprehension monitoring task, while type (2) is a problem-solving task. Monitoring capability is then measured based on the degree of agreement between the results of types (1) and (2) tasks.

In analyzing the characteristics of learners based on these results, it is apparent that students showing high agreement between the two types of tasks also tend to make a sustained effort to learn, while those exhibiting low agreement between the tasks tend to be lazier with respect to learning and figure higher in the drop-out rate.

3. Meta-Model to Construct Learner Models

Here, let us consider the meta-model that forms the foundation for this individual learner model. Table 1 shows a portion of a model capable of inferring metacognitive activity based on declarative knowledge monitoring and slide selection results.

Because the declarative knowledge monitoring and slide selection results reveal the state of a learner's knowledge at two different sequential points in time—that is, before and after the presentation design—this reveals whether a learner with insufficient or mistaken knowledge at the beginning before starting the presentation design project has reconstructed own knowledge through the presentation design task.

Based on this model, we can distinguish four basic types of learners in terms of metacognitive control during the presentation design process using the results of the declarative knowledge monitoring and slide selection:

MC Learners: Learners who recognizes through declarative knowledge monitoring tasks or presentation planning activities that "their knowledge is lacking, and correct their understanding by relearning." Learner types (2), (3), (10), and (11) fall into this category, that represents diligent learners who are really serious about learning.

NonMC Learners: Learners who recognizes through declarative knowledge monitoring tasks that their knowledge is mistaken or lacking, yet do not address the lack of knowledge in the presentation design activities, and do not make any effort to relearn. Learner types (5) and (8) fit into this category that represents lazy or indolent learners.

NonExpLStG Learners: Learners who, even after explaining the topic to another person, this does not trigger awareness that their own knowledge is wrong and they do not pursue relearning. Learner types (6) and (7) fall into this category.

NonReflective Learners: Learners who correctly understand learning items, yet have never considered the significance or placed the learning items in the target domain. Type (4) learners fall into this category. These are learners with only modest understanding of how to acquire transferable learning strategies.

Reflecting on these different types of learners, we should be able to generate appropriate advice tailored to each type. We will discuss this matter in another paper.

4. Conclusions

Table 1: Meta-model to Infer Learners' Meta-cognitive Activities through Presentation Design Activities

Slide attribute	Declarative Knowledge	Selection Results	Semantic interpretation of declarative results	Semantic interpretation of selection results	Semantic interpretation of metacognitive control		
Desirable	Correct content	Select	Understand	M_ (A) B_ (A)	M: Probably aware of importance	(1) —	
			Do not understand	M_ (B) B_ (B)		(2) Based on recognition understanding is lacking, probably correct understanding by relearning.	
			Wrong	M_ (C) B_ (C)		(3) Recognized own misunderstanding through presentation design activities, probably correct understanding by relearning.	
		Do not select	Understand	M_ (A) B_ (A)	M: Lack awareness of importance	(4) Probably no performing of thinking activity on the importance of a learning topic.	
			Do not understand	M_ (B) B_ (B)		(5) Recognized understanding is lacking, but probably understanding not corrected by relearning.	
			Wrong	M_ (C) B_ (C)		(6) Not aware of own misunderstanding through presentation design activities, and probably no relearning.	
	Undesirable	Wrong content	Select	Understand	M_ (C) B_ (C)	B: Domain knowledge is wrong	(7) Not aware of own misunderstanding through presentation design activities, and probably no relearning.
				Do not understand	M_ (B) B_ (B)		(8) Recognized understanding is lacking, but probably performed no relearning.
				Wrong	M_ (A) B_ (D)		(9) Probably no appropriate efforts during declarative knowledge monitoring.
		Do not select	Understand	M_ (C) B_ (C)	B: Probably understand correctly	(10) Recognized own misunderstanding through presentation design activities, probably correct by relearning.	
			Do not understand	M_ (B) B_ (D)		(11) Relearning based on awareness of misunderstanding, and it probably corrected.	
			Wrong	M_ (A) B_ (C)		(12) —	

B_ (A) : Likely that he understands correctly.

B_ (B) : Likely that he does not understand correctly.

B_ (C) : Domain knowledge is wrong.

M_ (A) : Learner thinks he understands.

M_ (B) : Learner thinks he does not understand.

M_ (C) : Learner does not recognize he is wrong.

Here we have described a learner model that captures learner attitudes based on presentation design activities. Through a declarative knowledge monitoring task we are thus able to partially detect the disparity between the state of the learner's knowledge and the state of the learner's belief, while also capturing the transformation that can be observed through presentation planning activities. In this study we have come up with a novel approach for inferring metacognitive activity of learners by focusing on the transformation of this disparity, then leveraging that information to capture the attitude of subjects toward learning. Building on this approach, we have already developed a scheme for generating advice and guidance based on the learner model described in the paper.

References

- Bransford, John, Ann Brown, and Rodney Cocking, eds., Brain, Mind, Experience, and School., in How People Learn, National Academy Press, Washington, DC, 2000
- Kazuhisa Seta and Mitsuru Ikeda: Presentation Based Meta-learning Environment by Facilitating Thinking between Lines: A Model Based Approach, in Toyohide Watanabe and Lakhmi C. Jain (Eds.): Innovations in Intelligent Machines-2 — Intelligent Paradigms and Applications —, Studies in Computational Intelligence, Vol. 376, Springer, pp. 143-166, (2011)

Tobias, S. & Everson, H.T: Assessing metacognitive knowledge monitoring. In G. Schraw (Ed.), *Issues in the measurement of metacognition*, pp.147-222. Lincoln, NE: Buros Institute of Mental Measurements and Erlbaum Associates. 2000

Feature Extraction of the Nursing Techniques from Hand Motion Data

Takeshi Matsuda^{a*}, Toshiyuki Maeda^b & Yukie Majima^c

^a *Department of Computer Science, Shizuoka Institute of Science and Technology, Japan*

^b *Faculty of Management Information, Hannan University, Japan*

^c *Faculty of Liberal Arts and Sciences, Osaka Prefecture University, Japan*

*tmatsuda@cs.sist.ac.jp

Abstract: It is not easy to acquire nursing techniques from lectures only, but research on transforming a tacit knowledge of nursing techniques into a formal knowledge has started recently. In this paper, we analyze the coordinate information of hand motion data in an intravenous injection, and discuss on the possibility of formulating information.

Keywords: Nursing techniques, Hand Motion Data, Tacit knowledge, Formal knowledge and Correlation matrix

1. Introduction

The knowledge which is hard to express by words is called as a tacit knowledge. On the other hand, the knowledge that can be expressed by text, mathematical expression and figure is called a formal knowledge. In the SECI model of knowledge creation theories (Ikujiro Nonaka & Hirotaka Takeuchi 1995), it is claimed that a tacit knowledge is transformed into a formal knowledge by discussion in an organization. In nursing techniques, tacit knowledge appears in various contexts such as intravenous injection and excretion care (Bowtell, L., Moloney, C., Kist, A.A., Parker, V., Maxwell, A., Reedy, N. 2012). As the study on the inheritance of nursing techniques, for example, the method of using a meta-synthesis of practical examples from prior reports had been proposed (Aya Ueta, et.al 2009).

Recently, the knowledge share system using video data based on SECI model had been innovated in the education of nursing techniques, and it is utilized to transform nursing techniques from a tacit knowledge to a formal knowledge. Moreover, the study to visualize the movement of hand motion during the running of nursing techniques has been starting, and it provides useful information to learner (Majima. Y., Maekawa, Y., Soga, M. 2012). By these recent studies, it can be said that the data including a tacit knowledge concerning nursing techniques are becoming computable by computer.

In this study, we investigated whether the hand motion data includes some tacit knowledge of experts by comparing with the data of learner. In the prosecution of this consideration, we analyzed the hand motion data of two experts and four learners (i.e. 6 testers) by computing correlation matrix of hand motion data. The hand motion data are obtained from 16 location sensors attached at their hand, and one sensor obtains three-dimensional coordinate. To extract the information of experts, we focused attention on the correlation of 16 sensors for each coordinate (i.e. x, y and z coordinate). From the result of data analysis, we could see that there exists important sensor to extract the feature of expert nursing techniques although the number of data is not enough. Furthermore, we proposed the evaluation function to measure the difference between two testers, and showed that the evaluation function could detect the difference between an expert and a learner in the data of this study.

2. Data Acquisition System and Hand Motion Data

2.1 Method of Data Acquisition

The system to get hand motion data had been developed and is using for the education of nursing techniques (Majima, Y., Maekawa, Y., Soga, M. 2012). In this study, we will analyze the data whose are obtained from this system. The system is LIBERTY 240/16 (POLHEMUS), and it has 16 location sensors. By using this system, we can obtain 240 three dimension coordinate data per second. We fixed 15 (3 sensors * 5 fingers) sensors at the central outside of a phalange and 1 sensor for measuring the reference position.



Figure 1. The scene of sensor wearing.

In this study, we analyze the hand motion data performing intravenous injections.

2.2 Pretreatment of Hand Motion Data

Since the time of intravenous injections differs by tester, the size of hand motion data is unequal. Therefore, we quantized data in the following way. Let (x_i, y_i, z_i) be the coordinate data of some sensor of the tester T_k for $i = 1, 2, \dots, I_k$ and $k = 1, 2, \dots, 6$, where I_k is the number of data, T_1, T_2 are experts and T_3, T_4, T_5, T_6 are learners. Since the data size is different in each tester, we transformed I_k into 70 and redefined three dimensions coordinate as $(\hat{x}_j, \hat{y}_j, \hat{z}_j)$ in the following way.

$$\hat{x}_j = \frac{1}{I'} \sum_{i=I'(j-1)+1}^{I'j} x_i, \hat{y}_j = \frac{1}{I'} \sum_{i=I'(j-1)+1}^{I'j} y_i, \hat{z}_j = \frac{1}{I'} \sum_{i=I'(j-1)+1}^{I'j} z_i,$$

where $I' = [I_k / 70] + 1$ and $[x]$ denotes the largest integer not greater than x .

3. Data Analysis and Result

We can express data as three 70×16 matrices whose are related to x , y and z coordinate in each tester. From these data, we analyzed the correlation of 16 sensors in each coordinate x , y and z by computing 18=(3 sensors \times 6 testers) correlation matrices (16×16 matrix). Then, we obtained the result that only y coordinate of experts has not correlation with each 16 sensors. Figure 2 is comparison of an expert's correlation matrix and a learner's one. It can be said that this is a big feature of expert's data. Therefore, we may measure the level of nursing techniques by using this feature.

We propose the evaluation function of the level of nursing techniques in the following way. From the above discussion, we had three correlation matrices R_{xk}, R_{yk} and R_{zk} . Here, R_{xk}, R_{yk} and R_{zk} are correlation matrices of x coordinate of tester T_k , y coordinate of tester T_k and z coordinate of tester T_k , respectively. Let r_{ij}^k be (i, j) element of correlation matrix R of tester T_k . We define the count function

$$d(k = k_1, k = k_2) = \frac{1}{16} \mathring{a} \mathring{a} \left| r_{ij}^{k_1} - r_{ij}^{k_2} \right|$$

Then, we got $d(k = 1, k = 2) < 0.08$. This means that there is not so much difference between expert's matrices. On the other hand, for $l = 3, 4, 5, 6$, we had

$$0.20 \leq d(k = 1, k = k_l), d(k = 2, k = k_l) \leq 0.32.$$

Hence, it may be said that the correlation matrix of hand motion data includes the expert's tacit knowledge, and have possibility that this information can be embedded into the learning system of (Majima, Y., Maekawa, Y., Soga, M. 2012).

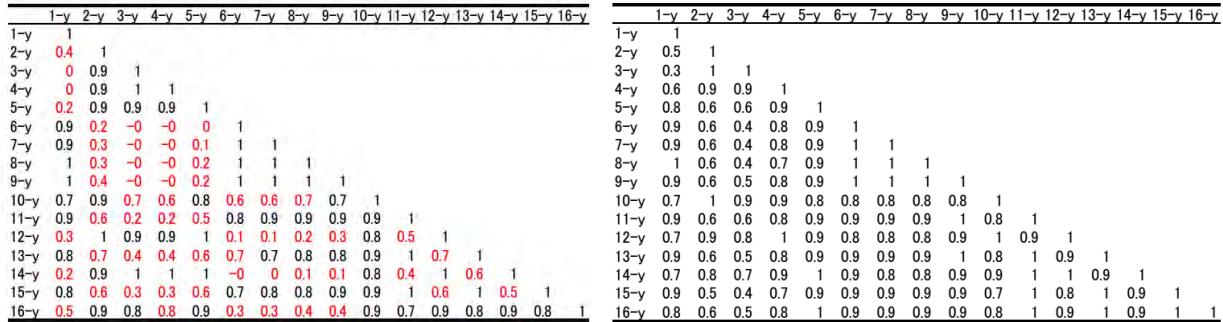

Figure 2. Correlation matrices of an expert's y coordinate (left) and a learner's one (right).

4. Conclusion

In this paper, we analyze the hand motion data during intravenous injections, we clarified that the correlation matrix of some location data may includes a tacit knowledge of nursing techniques. Our future works are the following two things. The one is to collect more data and verify the discussion of this paper, and the other is to develop the learning system based on the result of this paper.

Acknowledgements

We would like to thank Mr. Taiki Oosawa of Matsuda laboratory for supporting the computation of this paper.

References

Aya, U. Mayuko, T, J., Hsi, S., Yuko, O, M., Yoshimi, S., et al. (2009). CORPOREALITY IN NURSING PRACTICE OF ELIMINATION CARE : A Qualitative Meta-Synthesis of Practical Case Studies in the Japanese Literature. *Journal of Chiba Academy of Nursing Science*, 15(1), 68-75.

Ikujiro, N. & Hirota, T. (1995). The Knowledge-Creating Company: How Japanese Companies Create the Dynamics of Innovation. *Oxford Univ Press*.

Bowtell, L., Moloney, C., Kist, A.A., Parker, V., Maxwell, A., Reedy, N. (2012). Using Remote Access Laboratories in nursing education, 9th International Conference on Remote Engineering and Virtual Instrumentation (REV), 1-7.

Majima, Y., Maekawa, Y., Soga, M. (2012). Learning Support System Reproducing Finger Movements in Practicing Nursing Techniques, Proceedings of the 11th International Congress on Nursing Informatics, 278-282.

Inquiry-based learning for meta-cognitive training in semantic open learning space

Corentin JOUAULT & Kazuhisa SETA

Graduate School of Science, Osaka Prefecture University, Japan

*jouault.corentin@gmail.com

Abstract: This research's objective is to train learners' meta-cognitive skills in self-directed learning of history. Learners use a learning environment that provides support and regulates their learning processes using inquiry-based learning. Learners use the system to learn in an open learning space reinforced with semantic information. All the provided support is generated automatically using this semantic open learning space. The support is provided in the form of inquiry questions generated by the system. These questions are designed to direct learners to new information and trigger history thinking.

Keywords: Inquiry Based Learning, Self-directed Learning, Meta-Cognitive Training, History Learning, Question Generation, Semantic Open Learning Space, Adaptive Learning Support

1. Introduction

In self-directed learning, learners without the necessary skills have difficulties planning their learning. In an open learning space, such as the Internet, learners can easily become overwhelmed by the quantity of information available. To be able to achieve learning outcomes on the same level as classroom learning, learners need to acquire self-regulation skills.

Learners can be given inquiry in a learning environment, which can be used in a self-directed learning situation. Inquiry-based learning can support learners during self-directed learning by giving them smaller objectives. Giving inquiries to learners also make learners think about what they learned. In history, inquiry is also used in classroom to encourage learners to form an opinion (Husbands, 1996).

We previously proposed a novel learning environment to enhance self-directed learning in the domain of history learning using semantic web techniques (Jouault and Seta, 2013). Our system provides a learning environment to build a concept map while learning, in an open space, about a specified historical period. The originality of our system is that it uses a natural language open learning space (Wikipedia) reinforced by semantic information from two sources, DBpedia and Freebase. This process creates a "semantic open learning space" used by the system. The system can provide content-dependent questions depending on the learner's knowledge level. The generated questions are design to direct learners to new information but also to make them think about what they learned.

In this paper, we discuss the possibility of using our system to enhance meta-cognitive skills in self-directed learning of history. We designed a new version of our system that is not only aimed at improving domain understanding but also improving learners' history learning skills. By implementing inquiry-based learning support into our system, we hope to lastingly improve the learning processes of learners in self-directed learning of history.

2. Related Work

To support learners in self-directed learning, systems, such as the Navigation Planning Assistant (Kashihara and Taira, 2009), which provides an environment for describing learners' learning plans and states of understanding to prompt their self-regulation in an open learning space, have been developed. The limitation of this system, however, is that its support is content-independent due to the difficulty in working with natural language information on the Web. Of course, this problem can be overcome by preparing the learning materials in advance. This is the case of the Betty's Brain system (Biswas, Roscoe, Jeong and Sulcer, 2009) which involves using a concept map in learning by teaching environment. However, preparation requires a considerable amount of time even for constructing a

closed learning space. It is not possible to use the same method in an open learning space because there is too much material. In our system, the quality of semantic information is not as good as manually prepared information, but the process can be applied automatically for every concept. Therefore, it can be applied to an open learning space.

In meta-cognitive training using inquiry-based learning, the Web-based Inquiry Science Environment (WISE) (Slotta, 2004), which also provides support in self-directed learning but in the science domain. Learners using WISE gather information to answer a science inquiry. Learners are trained in designing solutions, debating science subjects, and critiquing the resources they learn. However, it requires specialists to prepare all the inquiries. In our system, the use of the semantic open learning space allows us to automatically generate all support.

3. Design rationale: Reinforcing inquiry-based learning

We have two objectives with our system:

- A) Reinforce the domain understanding of the subject learned. The system supports learners to help them learn the most important concepts and explore the relation between them.
- B) Reinforce learner skills for self-directed learning of history. The provided support is aimed to help the learner become aware of the important points during the study of an historical period.

Regarding objective A, the system provides support to help learners not only learn history but also understand it. In history learning, an understanding of chronology is necessary. Chronology is defined by Smart (1996) as “the sequencing of events/people in relation to other and existing knowledge of other, already known, events/people”. Learners need, of course, to know events but they also need to understand their context.

Regarding objective B, the system supports the acquisition of two level of awareness:

- Macro level: Inquiry driven self-directed learning process. Learners need to be made aware of the importance of setting objectives in self-directed learning. Learners using the system set an objective every time by choosing a question. Then, they learn from the document to be able to answer the question. Learners will be directly influenced by their choice of objective.
- Micro level: Context-dependent question generation. Learners need to become aware of the importance of asking relevant questions depending on their learning state. All the questions are generated depending on the machine understandable concept map built by the learners. Thus, they can make the connection between their knowledge and the generated questions.

The system, as illustrated in Fig. 1, is composed of four windows:

- Question window (a): the question window displays a list of questions generated by the system.

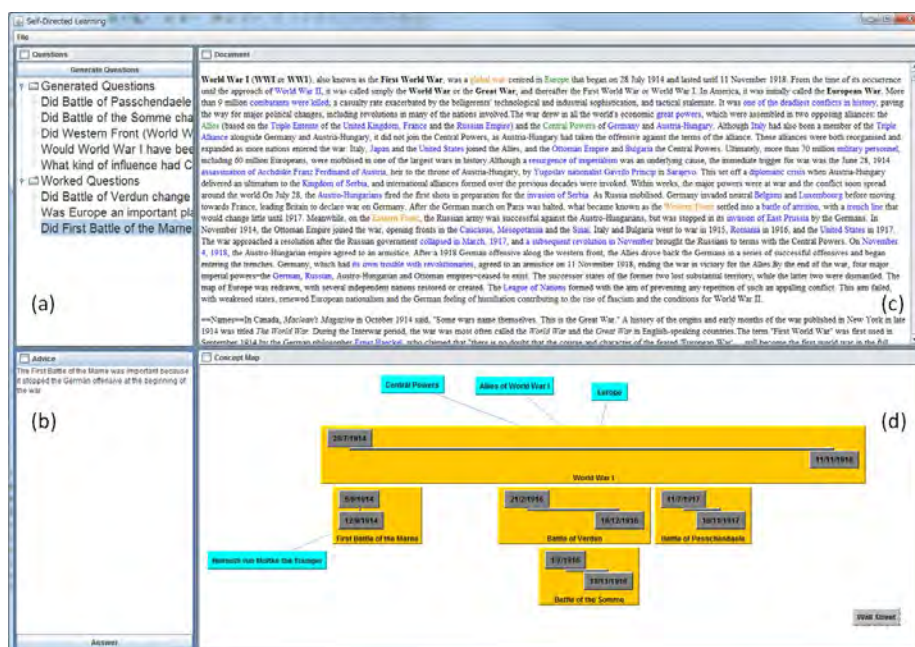

Figure 1. System interface

- Answer window (b): Learners can use this window to answer their active question. They can write their answer in natural language.
- Document window (c): This window displays the document the learner selected. The learner can click on the concepts in the documents to add them to the concept map.
- Concept map window (d): The concept map window is used both to display and manage the concept map. The display of the concept map is built for history learning. The events are organized on a timeline. The learners can also add relations between concepts.

The starting point of learning is the same for all learners: they are provided with the same list of questions. Learners will then build a concept map following what they think the answers to the questions are. Once learners give their answers to the questions, new questions will be generated depending on their concept map. All learners will be directed by the questions to help them correct the weaknesses in their concept map.

To support the acquisition of the macro level of awareness i.e. meta-cognitive training, before learning, learners need to set a learning objective by choosing a question. Then, learners need to gather information to be able to answer the questions. Repeating the process should make learners develop awareness of the importance of inquiry during self-directed learning of history.

The problem in providing good quality training is that the quality of the learning depends on the questions given during this process. According to Riley (2000), a good enquiry question in history should: “capture the interest and imagination of your pupils, place an aspect of historical thinking, concept or process at the forefront of the pupils' minds, result in a tangible, lively, substantial, enjoyable "outcome activity" through which pupils can genuinely answer the enquiry question.” To answer a questions learners should think about what they learned (Husbands, 1996). Generating such questions is possible by using the semantic open learning space.

To support the acquisition of the micro level of awareness, the system generates questions depending on the learner's concept map. Using the semantic information available, the questions will be relevant to the studied subject in most cases. The generated questions use types defined in Graesser's taxonomy (Graesser, Ozuru and Sullins, 2010) which are content-independent. The system uses its own ontology to create links among the questions, concept, and relation types. These natural language patterns are hand written for every concept type.

4. Concluding Remarks

In this paper, we described the additions made to our system to enable meta-cognitive training in self-directed learning of history. Using our semantic open learning space, we are able to automatically generate relevant inquiry questions which are used to train the learners' skills.

References

- Biswas, G., Roscoe, R., Jeong, H., & Sulcer, B. (2009). Promoting self-regulated learning skills in agent-based learning environments. In *Proceedings of the 17th international conference on computers in education* (pp. 67-74).
- Graesser, A., Ozuru, Y., & Sullins, J. (2010). What is a good question?. In *Bringing reading research to life*. Guilford Press.
- Husbands, C. (1996). *What is history teaching?: Language, ideas and meaning in learning about the past*. Berkshire: Open University Press.
- Jouault, C. & Seta, K. (2013). Building a Semantic Open Learning Space with Adaptive Question Generation Support. *Proceedings of the 21st International Conference on Computers in Education*
- Kashihara, A., & Taira, K. (2009). Developing Navigation Planning Skill with Learner-Adaptable Scaffolding. In *Proceedings of the 2009 conference on Artificial Intelligence in Education: Building Learning Systems that Care: From Knowledge Representation to Affective Modelling* (pp. 433-440). IOS Press.
- Riley, M. (2000). "Into the Key Stage 3 history garden: choosing and planting your enquiry questions." In: *Teaching History*, London: Historical Association
- Slotta, J. D. (2004). The web-based inquiry science environment (WISE): Scaffolding knowledge integration in the science classroom. *Internet environments for science education*, 203-232.
- Smart, L. (1996). Using I.T. in primary school history. London: Cassell.

Learning Method for Understanding Design Policy of Object-oriented Design and its Meta-learning Support System

Tomoko KOJIRI^{a*}, Hiroki OOE^b, & Kazuhisa SETA^c

^aGraduate School of Science and Engineering, Kansai University, Japan

^bFaculty of System Science and Engineering, Kansai University, Japan

^cGraduate School of Science, Osaka Prefecture University, Japan

*kojiri@kansai-u.ac.jp

Abstract: Design pattern is a description of the object-oriented design that gives high-quality and re-usable solutions for frequently occurring problems. A design pattern is formed based on the various experiences of predecessors who made ineffective designs. If students can grasp the design policy of predecessors from the design pattern, they can create good designs and apply them to new problems. The objective of this research is to propose a learning method for understanding design policy of the design pattern and to construct a meta-learning system for proposed learning method.

Keywords: design policy, experiential knowledge, meta-learning support system

1. Introduction

Design patterns are experiential knowledge for designing better object-oriented programs. They have re-usability and extensibility advantages, so a policy of constructing re-usable and extensible designs in object-oriented designs can be found in the process of forming design patterns. If students can follow the processes of the predecessors who created design patterns, they might learn such good design policy. However, most textbooks of design patterns only describe their definitions and show how to use them (Gamma et al. 1994, & Freeman et al. 2004); since the creation process is not clearly mentioned, students are not able to consider the design policy.

To understand design policy, we believe that following the thinking process of predecessors is effective. The objective of this research is to support students to understand design policy by introducing a new learning method that repeatedly creates ineffective design from the good design and compares effective and ineffective designs under the various conditions. This activity corresponds to the part of the predecessors' processes of creating design patterns to give students a chance to identify good design policy. Some traditional researches give problems that are solved by design patterns and encourage students to create design patterns by themselves (Weiss 2010 & Pillay 2010). This approach is effective if students can derive design patterns by themselves. However, many have difficulty creating them from scratch. Therefore, in our approach, a program based on a design pattern (*design pattern program*) is given and students transform the given program into an inappropriate one (*alternative solution*). Then they compare the design pattern programs and the alternative solutions for a new problem (*extended problem*), which is an extended problem of the original one. By repeating this process and considering the alternative solutions with several different extended problems, the design pattern's design policy can be experientially acquired.

2. Approach

When encountering a problem, predecessors created various solutions by trial-and-error and evaluated the quality of their solutions based on how much they need to be modified based on extended problems. During the trial-and-error process, good solutions are selected based on the predecessors' criteria and the final solution becomes a design pattern. Special structures in each design pattern, such as the types of classes and their relations, reflect design policy. Therefore, to replace the special structure in the design pattern program with another structure that can perform the same behavior may lead students to consider the following questions and to learn the design policy of predecessors.

- What special structure is embedded in the design pattern program?
- What kinds of problems can be solved by the design pattern?

Figure 1 illustrates our learning method for understanding design policy. From the given design pattern program, students create alternative solutions. The inappropriateness of the alternative solutions and the effects of the design pattern program are evaluated under the extended problems.

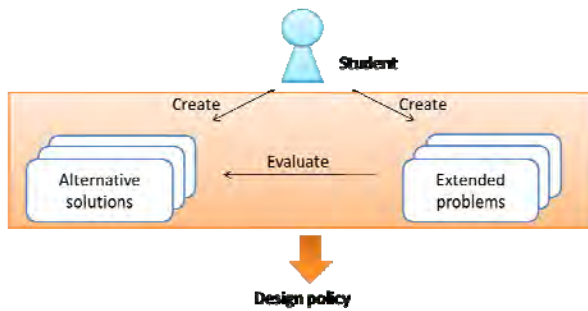

Fig. 1 Method for learning design policy

which supports the creation of alternative solutions from the given design pattern program, holds several alternative solutions as expected answers. It examines the alternative solutions created by students and leads them to derive expected answers. On the other hand, the solution evaluation sub-system gives an example of extended problems so that students can evaluate the qualities of the design pattern program and the alternative solutions. This sub-system is invoked immediately after students have created alternative solutions in the alternative solution creation sub-system. Extended problems are given as multiple-choice questions (Table 1) that ask the part of the programs that should be modified under the extended problems. These questions themselves promote the students' activities of considering the design policy.

Table 1 Example of extended problem for Adapter pattern

<p>[Extension of problem] Change the <i>Adaptee</i> class with <i>methodA</i> to <i>Adaptee2</i> class with <i>methodB</i>. Consider which parts you need to modify in both class diagrams.</p> <p>[Answer] You only need to [1] [2] in class [3] for a design pattern program, but you have to [4] [5] in class [6] for an alternative solution.</p> <p>[Choices for each blank]</p> <p>1, 4: Type of modification: change, add, or eliminate</p> <p>2, 5: Target of change, e. g., names of the method, the instance, or the constructor</p> <p>3, 6: Name of existing class</p>

3. Alternative Solution Creation Sub-system

The alternative solution creation sub-system provides a supporting environment for creating alternative solutions from the given design pattern program. Since its structure in the object-oriented design can be illustrated by a class diagram, our system gives the design pattern program as a class diagram and provides an interface in which the given class diagram can be changed (Fig. 2). The given class diagram is shown on the class diagram display unit. The class diagram can be edited by inputting the class name or the relation name or selecting the class or the relation to remove from the class diagram edit unit. When the re-illustration button is pushed, the class diagram that satisfies the inputted classes and relations is depicted in the class diagram display unit.

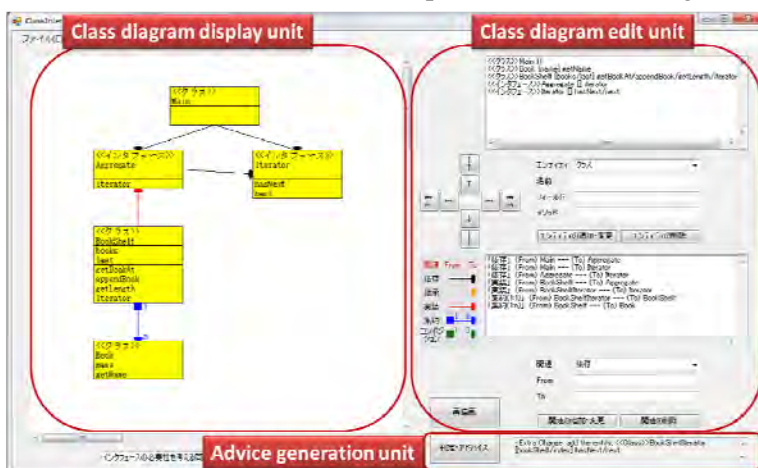

Fig. 2 Interface of alternative solution creation sub-system

relations is depicted in the class diagram display unit.

The system holds the class diagrams of the expected alternative solutions and evaluates those created by students. If a student's class diagram does not match its alternative solutions, advice is generated in the advice generation unit that indicates the differences of the entities or the relations from the expected alternative solution.

4. Solution Evaluation Sub-system

After a student successfully creates one of the expected alternative solutions, the solution evaluation sub-system starts. It displays two windows. One show the extended problem, which consists of problem and answer sentences with blanks and lists of answer choices (Fig. 2). Students need to select one choice for each blank from the list. The other window illustrates the class diagrams of the design pattern program and alternative solutions created by students (Fig. 3). This window is used for comparing the quality of the design pattern program and the alternative solution under the given extended problem. Students can invoke edit windows for freely changing these class diagrams. In addition, by clicking on the classes in the class diagrams, the programs of the classes are displayed.

The system holds the extended problem answers. When students push the answer button, it evaluates the answer and gives advice, if necessary. Currently, three kinds of advice are prepared. Since it is effective to create class diagrams that are modified based on the extended problem, the first piece of advice explains how to modify the class diagrams. The advice is shown in the advice generation unit in Fig. 3. If students are still not able to derive the answer, the system indicates the part of the program that should be changed under the extended problem as the next piece of advice. If students are not able to answer correctly based on the second bit of advice, the system provides text that points out the incorrect choices and explains how to select the right choice

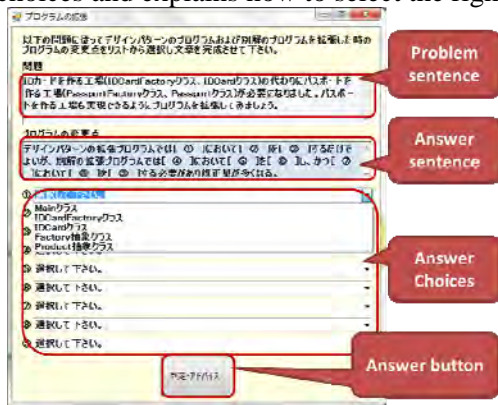

Fig. 2 Window displaying extended problem

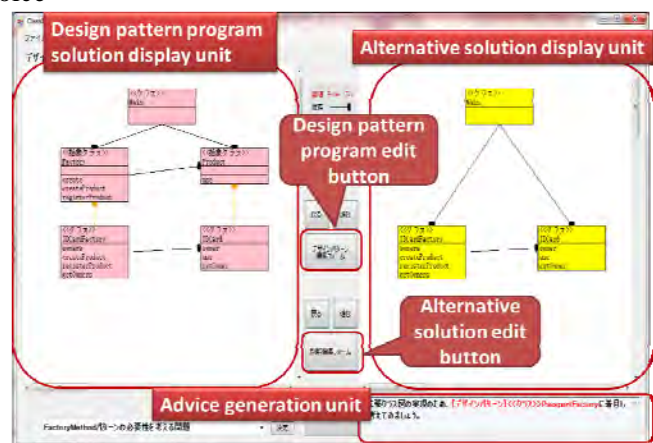

Fig. 3 Window showing class diagrams of design pattern program and alternative solution

5. Conclusion

In this research, we proposed a learning method to acquire design policy by redesigning a design pattern program to reach alternative solutions. In addition, we constructed a meta-learning system in which students can learn the proposed learning method. The alternative solution creation sub-system supports the creation of alternative solutions from the design pattern program. On the other hand, the solution evaluation sub-system supports the evaluation of alternative solutions and the design pattern program by providing extended problems.

In the current system, extended problems are given by the solution evaluation sub-system. However, knowing how to extend the original problem is also important for evaluating designs. The ability to create appropriate extended problems is also worth supporting. Therefore, in future work, we need to extend our system to support trial-and-error activities not only to create alternative solutions but also to derive appropriate extended problems.

Acknowledgements

This work was partly supported by the Telecommunications Advancement Foundation.

References

- Freeman, E., Robson, E., Bates, B., & Sierra, K. (2004). Head First Design Patterns, *O' Reilly Media*.
- Gamma, E., Helm, R., Johnson, R., & Vissides, J. (1994). Design Patterns: Elements of Reusable Object-Oriented Software, *Addison-Wesley Professional*.
- Pillay, N. (2010) Teaching Design Patterns, *Proc. of SACLA*.
- Weiss, S. (2010). Teaching Design Patterns by Stealth, *Proc. of SIGCSE 2005*, 492-494.

Question Type Analysis for Question-Answering Applications in Education

Yang-Yin Lee^a, Chih-Chieh Shao^b, Yen-Pin Chiu^b, Yong-Siang Shih^a, Hsin-Hsi Chen^{a,b*},
Chieh-Jen Wang^c and Sen-Chia Chang^c

^a*Department of Computer Science and Information Engineering,*

^b*Graduate Institute of Networking and Multimedia,
National Taiwan University, Taipei, Taiwan*

^c*Intelligent Analytic Technology Division, Computational Intelligence Technology Center,
Industrial Technology Research Institute, Hsinchu, Taiwan*

*hhchen@ntu.edu.tw

Abstract: In this paper, we present a question-answering (QA) system as a virtual tutor for students in the 5th and 6th grades. Students ask questions and the QA system gives answers to their questions based on a knowledge base. Teaching materials for history and geography are considered as a knowledge source. Because question log is not available in developing QA systems, multiple choice questions (MCQs) in the learning and testing materials are regarded as a training corpus to learn question types, answer types and keywords for retrieval, where an MCQ consists of a stem and a set of options. Options from the same MCQ are grouped into a cluster. Clusters with common elements are merged into a larger cluster. A cluster is labelled with a nominal element selected from the corresponding stems. We also mine question patterns from the stems for question type analysis in the QA system. Because the questions created by instructors in MCQs and the questions asked by students may be different, we develop a procedure to collect possible questions from students in the 6th grade. In the experiments, we first evaluate the question type classification systems using the MCQ corpus and the student corpus with 5-fold cross validation, respectively. Then we train question type classifiers with the complete MCQ corpus, and test them on the student corpus. The student's and the instructor's questions are compared and analyzed.

Keywords: Computer-assisted learning, question-answering systems, student intent analysis, text mining

1. Introduction

QA system can be introduced to the education domain for collaborative learning, online education and distance learning (Wang et al., 2006; Wen et al., 2012). In this paper, we focus on developing QA applications in education as virtual tutors. Students can post questions anytime anywhere after class, and computer-assisted learning systems response answers to their questions.

A typical question answering system is composed of question type analysis, query formulation, passage retrieval, and answer extraction (Ravichandran and Hovy, 2002). Question type analysis, which aims to understand users' intents, provides important clues for the latter tasks. The clues include the question part referencing to the answer, terms indicating the type of entities being asked for, and a classification of the question into some broad types (Lally et al., 2012). Query log which keeps users' information needs provide some prior knowledge for question type analysis, but it is not always available for all the application domains.

This paper utilizes multiple choice questions (MCQs) in learning and testing materials to mine question patterns to support QA systems in education domain. Section 2 specifies an instructors' MCQ corpus and a students' question corpus used in this study. Their question type distributions are shown and discussed. Section 3 evaluates the question type classifiers with these two corpora. Section 4 concludes the remarks.

2. Question Corpora Used in This Study

2.1 Instructors' Multiple Choice Questions (MCQ) Corpus

Question type, answer type, and the keywords to retrieve potential passages containing answers are three major elements in a question. An MCQ corpus based on the learning and testing materials is used to mine the important information. An MCQ consist of a stem and 4 options. The stem describes the questions to be asked and the options list the possible answers. The following shows an example.

What sea area separates Taiwan and South Korea? (a) Bashi Channel (b) East China Sea (c) South China Sea (d) Taiwan Strait

In this example, the trigger for the question type is “*what*”; the trigger for the answer type is “*sea area*”; and the keyword for retrieval contains the predicate “*separate*” and the related arguments.

We aim to mine entities, entity type, question type, and the relation among entities from MCQs in the teaching materials. A mining algorithm is shown below.

- (1) Collect initial clusters from the options in the same MCQ.
- (2) Merge clusters with common elements into a larger cluster.
- (3) Partition stems in MCQs based on the clusters derived from (2).
- (4) Assign a label to each cluster with nominal keywords in the stems.
- (5) Find the question patterns for each cluster.
- (6) Extract the relations among entities.

2.2 Students' Questions Corpus

The users of the proposed question-answering system are students in the 5th and 6th grades. In this study, we would like to know how children formulate their questions, and the effects of fuzzy questions and incomplete questions on students' question type analysis and question-answering.

Sample topics about history or geography are given first, and then three different methods are proposed to guide students to formulate questions. Method 1, which rewrites the given sentences from declarative to interrogative, is the simplest way. Method 2, which keeps the same answer, but presents different views, is more complex. Method 3, whose answer is different from the original topic, is the most complex. The following lists an example.

Sample Topic: Zheng Chenggong led his troops across the sea to Taiwan, expelled the Dutch, and made Taiwan to be a base for rebelling Qing dynasty and rebuilding Ming dynasty.

Method 1: Please change the above declarative sentence into an interrogative sentence whose answer is “Zheng Chenggong”, e.g., “Who expelled the Dutch who occupied Taiwan?”

Method 2: Please list questions whose answer is “Zheng Chenggong”, e.g., “Who was called Koxinga?”

Method 3: Please list questions related to “Zheng Chenggong” and their answers, e.g., “Where did Zheng Chenggong land Taiwan?”

2.3 Corpus Annotation and Comparison

There are 11 common question types including (T1) people, (T2) event, (T3) time, (T4) location, (T5) object, (T6) quantity, (T7) application, (T8) theory, (T9) reason, (T10) nickname, and (T11) language. We label a question type for each question. Table 1 lists the distribution of the 11 types in the MCQ corpus (M) and the student corpus (S). These two corpora contain 593 and 395 instances, respectively. The top 5 types in the MCQ corpus are location (45.36%), object (12.48%), theory (11.80%), reason (9.28%) and people (7.92%). They occupy 86.84% of instances. Comparatively, the top 5 types in the student corpus are location (23.04%), time (21.77%), object (17.97%), people (16.46%) and event (8.61%). They cover 87.85% of instances. Location is the most interesting type in the two corpora. Object and people types are also interesting to instructors and students. Surprisingly, only 0.84% of the instances are related to event type in the MCQ corpus. In contrast, 8.61% of students' questions related to this type. Similarly, 11.80% of instructors' questions touch on theory, but only 1.01% of students' questions belong to this type. It may be because this type of questions is difficult to be formulated by students. In both corpora, quantity, nickname and language are the three minority types.

Table 1: Distribution of question types in the two experimental corpora.

	(T1)	(T2)	(T3)	(T4)	(T5)	(T6)	(T7)	(T8)	(T9)	(T10)	(T11)
M	47	5	30	269	74	9	31	70	55	1	2
%	7.92	0.84	5.06	45.36	12.48	1.52	5.23	11.80	9.28	0.17	0.34
S	65	34	86	91	71	3	10	4	23	1	7
%	16.46	8.61	21.77	23.04	17.97	0.76	2.53	1.01	5.82	0.25	1.77

3. Question Type Analysis

In the first set of experiments, we train and test the question type classifiers by 5-fold cross validation with the MCQ corpus and the student corpus, respectively. In the second set of experiments, we train the question type classifiers with the complete MCQ corpus, and test it with the student corpus. L2-regularized L2-loss support vector classification in LIBSVM (Chang and Lin, 2011) is adopted. Two sets of features are explored. The first contains triggers for question types, triggers for answer types and the relation keywords. The second contains bigrams and trigrams features. All the features are binary. Table 2 lists the accuracies of the proposed classifiers. Using triggers and relation keywords is better than using 2-grams and 3-grams in all the evaluation experiments. The classification performance in 5-fold cross validation on the student corpus with the triggers and relation keyword approach is better than that in 5-fold cross validation on the MCQ corpus. There are performance drops from cross validation on the MCQ corpus to testing on the student corpus.

Table 2: Accuracies of the proposed question type classifiers.

	Triggers and relation keyword	2-grams and 3-grams
5-fold cross validation on the MCQ corpus	0.7707	0.7673
5-fold cross validation on the student corpus	0.8608	0.7468
Test on the student corpus	0.5848	0.4734

4. Conclusion

To understand how children formulate their questions, we design a procedure to collect students' questions and analyze the qualities of the questions. We found that 155 of 683 students' questions, i.e., 22.69%, contain some incomplete, vague, ambiguous or erroneous information to QA systems. The experimental results show that the classification system using triggers and relation keywords achieves accuracies 0.7707 and 0.8608 when 5-fold cross validation on the MCQ corpus and the student corpus are adopted, respectively. The system trained with the MCQ corpus and tested on the student corpus has accuracy 0.5848.

References

- Chang, C.-C. and Lin, C.-J. (2011). LIBSVM: A Library for Support Vector Machines. *ACM Transactions on Intelligent Systems and Technology*, 2(3), 27:1–27:27.
- Lally, A., Prager, J.M., McCord, M.C., Boguraev, B.K., Patwardhan, S., Fan, J., Fodor, P., & Chu-Carroll, J. (2012). Question analysis: How Watson reads a clue. *IBM Journal of Research and Development*, 56(3/4), 2:1-2:14.
- Ravichandran, D. & Hovy, E. (2002). Learning surface text patterns for a question answering system. In *Proceedings of the 40th Annual Meeting of the Association for Computational Linguistics* (pp. 41-47).
- Wang, C.C., Hung, J.C., Yang, C.Y., & Shih, T.K. (2006). An application of question answering system for collaborative learning. In *Proceedings of the 26th IEEE International Conference on Distributed Computing Systems Workshops*.
- Wen, D., Cuzzola, J., Brown, L. & Kinshuk (2012). Instructor-aided asynchronous question answering system for online education and distance learning. *The International Review of Research in Open and Distance Learning*. <http://www.irrodl.org/index.php/irrodl/article/view/1269/2369>.

Revealing Students' Thinking Process in Problem-Posing Exercises: Analysis of First Sentence Selection

Nur HASANAH^{a*}, Yusuke HAYASHI^a & Tsukasa HIRASHIMA^a

^a*Dept. of Information Engineering, Hiroshima University, Japan*

*nur@lel.hiroshima-u.ac.jp

Abstract: We have developed a computer-based learning environment called MONSAKUN to realize learning by problem-posing, where students pose arithmetical word problems by selecting and arranging several sentence cards. As the next step of MONSAKUN development, we analyze the sentence selection process which is considered to reflect students' thinking process. In the first step of analysis, we focused on first sentence selection. We found that the selection approach changed based on different type of story and students' exercise experience. This result is an important step towards building elaborate process model of problem-posing and adaptive support of the process.

Keywords: Arithmetical word problems, learning analytics, problem posing, reverse thinking problem, sentence integration

1. Introduction

Problem posing practice, one of the central themes in mathematics education, involves the generation of new problems in addition to solving pre-formulated problems (English, 1998). In learning by problem posing, one of the most important issues is the way to assess and give feedback to posed problems. In traditional problem posing method, teachers and students were faced with difficulties to conduct the learning activities effectively. It is not easy for students to pose mathematically correct problems in a given time, and teachers were having problems to assess and give feedback to the wide variation of problems that students pose. The inefficiency of time and available method made problem posing activity less attractive for most mathematics educators.

In order to realize learning by problem-posing in a practical way, we have been investigating a computer-based learning environment to assess and give feedback to problems posed by students (Hirashima et al., 2007). The software, named MONSAKUN (means "Problem-posing Boy" in Japanese), provides an interactive support for learning arithmetical word problems solved by one operation of addition/subtraction. The practical use of MONSAKUN at several elementary schools has been reported in previous studies (Hirashima et al., 2007; Yamamoto et al., 2013).

In this study, we examine how learners pose arithmetical word problems as sentence integration on MONSAKUN. Our assumption is learners do not choose sentence cards randomly - they arrange sentence cards based on some sort of thinking. In the analysis, as the first step toward analyzing problem-posing activity, we especially focus on what kind of sentence card was firstly selected by the learners in different types of story.

2. Analysis of First Sentence Selection from MONSAKUN Log Data

2.1 Modeling of Problem Posing Activity in MONSAKUN

The interface of an assignment in MONSAKUN is shown in Figure 1. A learner is provided with a set of sentence cards and a numerical expression, and then he/she is required to pose an arithmetical word problem using the numerical expression by selecting and arranging appropriate cards.

While it is difficult to trace thinking process in a free problem posing activity, we can trace learners' card selection in MONSAKUN which can be considered to reflect their thinking process. Learner's assignment is to choose appropriate cards from several sentence cards provided by the system in order to fill the requirement of numerical expression and story type.

In MONSAKUN, problem posing can be considered as combinatorial search of sentences. Figure 2 illustrate a search space of problem posing in a MONSAKUN assignment which provides six sentence cards. This search space is a tree structure of combination of cards. Here, the root is the starting point and the numbers represent identifiers of cards. For example, the starting point is empty and the combination of cards 1, 2 and 3 indicates the correct answer at the top left. The links between nodes represent possible paths that learners can follow in selecting cards during their problem posing activity.

Bold links in Figure 2 represent links actually followed by learners in a particular assignment. This indicates that not all paths were followed by learners. From this fact, there is a possibility that learners choose combination of cards based on some sort of thinking processes. The goal of this study is to investigate tendencies of students to choose cards. Especially, this study pays attention to the first card that learners select at the start of each assignment.

2.2 Change of Approach through the Problem Posing Activity

In this research, the analysis of MONSAKUN log data from an experiment of MONSAKUN used by eleven undergraduate students from Faculty of Education is reported. We analyzed the subjects' log data in assignments at Level 1 (lowest difficulty) and Level 5 (highest difficulty) which require the subjects to pose forward-thinking problems and reverse-thinking problems, respectively. Both levels consist of 12 assignments and four story types: combination, increase, decrease, and comparison.

The sentence cards in MONSAKUN contain different number according to the given assignment. Here, cards are distinguished by the order of numbers in the required calculation expression. For example, in an assignment "Make a story problem about "How many are the difference" that can be solved by $7 - 3 = _$ ", where the required calculation is " $7 - 3 = _$ "; a card contains the first number (7) is called "first number card". Similarly, a card contains the second number (3) or the third number (blank) is called "second number card" or "third number card", respectively.

From the analysis, we found that the proportion of each sentence card to be selected firstly is entirely not even. In Level 1, the percentage of first, second, and third number card being firstly selected are 91.8%, 3.3% and 4.9%, respectively. However, in Level 5, the percentage changed to 58.7%, 16.5% and 24.8%, respectively. We found that there is a bias against first selected card, which shows our assumption that the subjects did not choose a card randomly, but with some sort of approach. Furthermore, there is a different trend between Level 1 and 5. We presume that this difference between Level 1 and Level 5 appeared because subjects had different approach to pose either forward-thinking or reverse-thinking problems.

Table 1 shows the characteristics of first selected card from each assignment at Level 5 that has marginal or significant difference in number of selection from the average. These results were

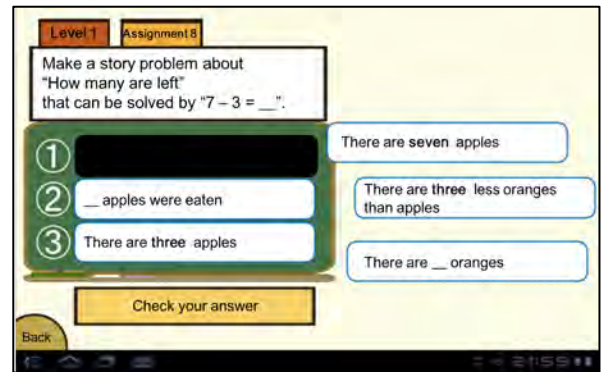

Figure 1. Interface of MONSAKUN

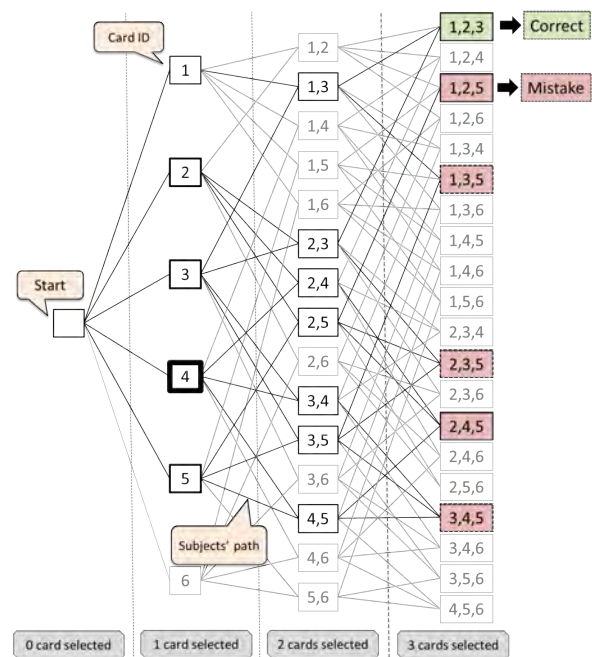

Figure 2. Illustration of a search space in a MONSAKUN assignment

analyzed with binomial test to the amount of each card being firstly selected or not in each assignment. Binomial test is an exact test of the statistical significance of deviations from a theoretically expected distribution of observations into two categories. Based on our assumption that students posed problems by selecting cards through a thinking process, we expect the distribution of first selected cards to have a significant difference in comparison with other cards.

Table 1. Result of binomial test of first selected card in Level 5 assignments

Assignment Number	Type of story	Order of assignment	Type of first selected card	Type of sentence	p-value	
1	Combination	1 st	First number card	Existence	7.05×10^{-5}	**
2		2 nd	First number card	Relational	1.88×10^{-7}	**
3		3 rd	First number card	Relational	1.97×10^{-3}	**
4	Increase	1 st	First number card	Existence	1.89×10^{-5}	**
5		2 nd	Second number card	Existence	0.0504	+
6		3 rd	First number card	Existence	0.0504	+
7	Decrease	1 st	First number card	Existence	2.35×10^{-4}	**
8		2 nd	Second number card	Existence	2.35×10^{-4}	**
9		3 rd	Second number card	Existence	2.35×10^{-4}	**
10	Comparison	1 st	-	-	-	
11		2 nd	Third number card	Relational	0.0266	*
12		3 rd	Third number card	Relational	0.0266	*

** : significant difference ($p < .01$), * : significant difference ($p < .05$), +, marginal difference ($p < .1$)

Subjects are firstly given simple forward-thinking problems to pose at Level 1 of MONSAKUN. Here, we found that they first simply selected an existence sentence card with the first number in the required calculation expression, and then proceeded to choose other appropriate cards. This approach worked well for Level 1. When subjects arrived at Level 5 Assignment 1, they initially approached the assignment with the same way of thinking. However, this did not work well, and they tend to make more mistakes than in the previous levels. We presumed that the subjects were aware that the previous approach did not work for reverse-thinking problems, because as seen in Table 1, in Level 5 Assignment 2 they selected different type of card, which is a relational sentence card containing first number. In a similar way, subjects changed their approach from the first order of assignment in a type of story to the second and third order of assignment in the same story type.

This leads to two findings about changes in subjects' way of thinking through the exercises. The first one is that subjects change their approach to pose problems after they had experienced posing the same story type. The next finding is that the change of approach depends on the story type.

These changes of thinking approach seem to bring a good effect, because in comparison to the first order of assignment in a story type, the average of steps and mistakes in the second and third order of assignments of the same story type are mostly decreased.

3. Concluding Remarks

In this research, we have conducted analysis of MONSAKUN log data of university students to investigate their thinking process in problem-posing activity. We found that depending on type of story and subjects' exercise experience, they selected different first sentence card. These findings proved our assumption that users of MONSAKUN did not chose sentence cards randomly, but with some sort of thinking process.

References

- English, L. D. (1998). Children's problem posing within formal and informal contexts. *Journal for Research in Mathematics Education*, 29(1), 83-106.
- Hirashima, T., Yokoyama, T., Okamoto, M., Takeuchi, A. (2007). Learning by Problem-Posing as Sentence-Integration and Experimental Use. *Proceedings of AIED2007*, pp254-261.
- Yamamoto, S., Kanbe, T., Yoshida, Y., Maeda, K., & Hirashima, T. (2013). Learning by Problem-Posing with Online Connected Media Tablets. *Proceedings of HIMI/HCI 2013*, Part III, 165-174.

Towards an Evaluation Service for Adaptive Learning Systems

Alexander Nussbaumer^{1*}, Christina M. Steiner¹, Eva-Catherine Hillemann¹, Dietrich Albert^{1,2}

¹*Knowledge Technologies Institute, Graz University of Technology, Austria*

²*Department of Psychology, University of Graz, Austria*

*alexander.nussbaumer@tugraz.at

Abstract: This paper presents a service that supports the evaluation of adaptive learning systems. This evaluation service has been developed for and tested with an adaptive digital libraries system created in the CUTLURA project. Based on these experiences an approach is outlined, how it can be used in a similar way to evaluate the features and aspects of adaptive learning systems. Following the layered evaluation approach, qualities are defined that are evaluated individually. The evaluation service supports the whole evaluation process, which includes modelling the qualities to be evaluated, data collection, and automatic reports based on data analysis. Multi-modal data collection facilitates continuous and non-continuous, as well as invasive and non-invasive evaluation.

Keywords: Evaluation service, layered evaluation, adaptive learning systems

1. Introduction

Evaluation is an important task, because it reveals relevant information about the quality of the technology for all stakeholders and decision makers. It involves collecting and analysing information about the user's activities and the software's characteristics and outcomes. Its purpose is to make judgments about the benefits of a technology, to improve its effectiveness, and to inform programming decisions (Patton, 1990). The evaluation process can be broken down into three key phases: (1) Planning, (2) collecting, and (3) analysing (Cook, 2002). However, conducting evaluations is usually a time consuming task. Besides planning and data collection, it requires a lot of time to analyse the collected evaluation data. Including log data in the evaluation further increases the evaluation task and also makes it more complex. In order to address these aspects needed for a sound and systematic evaluation and to reduce workload for the evaluator, a holistic conceptual and technical approach has been created and based on that the evaluation service Equalia has been developed (Nussbaumer et al., 2012). This approach and the developed service has been tried out and tested in the context of the digital library project CULTURA (<http://cultura-project.eu/>). This paper suggests that this approach and service can also be applied to evaluate adaptive learning systems.

2. Evaluation Approach and Conceptual Design

In order to evaluate adaptive learning systems, Brusilovsky et al. (2004) propose a layered evaluation approach. Instead of evaluating a learning system as a whole, they suggest to evaluate the core components, which are user modelling and the adaptation decision making. This approach has been extended in the GRAPPLE project, where also other aspects are evaluated, for example usability, user acceptance, and adaptation quality (Steiner et al. 2012). A similar approach has been applied on the digital library system CULTURA that serves as an adaptive information system for historians. Relevant qualities have been defined and evaluated individually including usability, user acceptance, adaptation quality, visualization quality, and content usefulness (Steiner et al., 2013). Though applied in digital libraries, these aspects are also relevant in adaptive learning systems.

The general goal of the evaluation service is to support the whole evaluation process, consisting of planning the evaluation, carrying out the evaluation, as well as analysing the data and creating reports

(Fig. 1). The evaluation model is the core part of the conceptual approach. It allows for explicitly modelling what and how should be evaluated. Therefore, the evaluation model formally represents the evaluation approach and thus represents the evaluator’s expertise. It consists of two parts. First, the quality model is an abstract model that defines what should be evaluated. It defines evaluation aspects (such usability (Brooke, 1996), user acceptance (Davis et al., 1989), or recommendation quality), which express the qualities of a system including its content. Second, the survey model defines the items for measuring these quality aspects. Items might be concrete questions, but can also be specifications, how tracking data covers the user’s behaviour (for example, how often a user follows a recommendation).

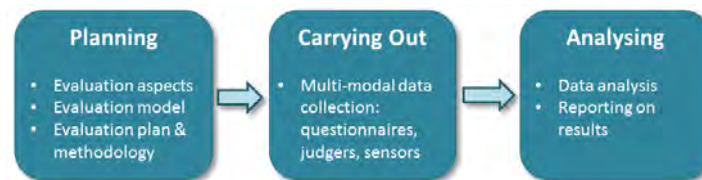

Figure 1: Evaluation Process as supported by the Equalia evaluation service.

The data collection approach consists of two main aspects. First, the data collection instruments are based on the evaluation model and thus related to system qualities that should be evaluated. Second, three different types of instruments are defined (questionnaires, sensors, judgets) that allow data collection on different dimensions, namely invasive and non-invasive, as well as continuous and non-continuous data collection. Questionnaires are the traditional way of capturing data about the user's opinion. A different way of collecting evaluation data is realised with judgets, which are little widgets integrated in the system to be evaluated where users can give immediate feedback (e.g. ratings). Software sensors are instruments that establish a continuous and non-invasive evaluation method. Sensors are not visible to the users, but monitor and log the interaction and usage behaviour, and collect evaluation data in this way.

An important feature of the evaluation system is the generation of automatic reports from the collected evaluation data on the basis of the underlying evaluation model. A report is made upon a survey model by aggregating all participants’ data related to the respective survey model. The data from different sources (questionnaire, judgets, sensors) are compared according their relations to quality aspects. Thus overall scores for each quality are calculated.

3. Application in Adaptive Learning Environments

In order to apply this approach and the Equalia service in adaptive learning environments, the most important step is to identify which qualities should be evaluated and how the measurement can be accomplished. Beside the aforementioned qualities, such as usability, usefulness, and content quality, in typical adaptive learning systems, the qualities outlined in Tab. 1 are of specific interest:

Quality Name	Explanation	Measurement
recommendation quality	how well are learning resources recommended to the learner	(1) ask the learner about appropriateness; (2) track how often learners follow a rec. resource
visualisation quality	how useful are visualisations for the learner	(1) ask learner about usefulness of vis. (2) track how often learner uses a visualisation
collaboration quality	how good is the collaborative support to interact with peers	(1) ask learner about benefit of coll. mechanisms; (2) track how often learner uses coll. features

Table 1: Possible evaluation qualities and measurement methods in adaptive learning systems.

Integration with an adaptive learning system is easy, because the Equalia service is an independent Web service that can be loosely coupled with the system to be evaluated (Fig 2). It exposes a REST interface to collect evaluation data from different sources. Judgets and sensors have to be integrated in the adaptive learning system capturing the user's opinion and monitoring the user's system interactions and sending them to Equalia. Furthermore, Equalia provides a Web interface for creating and managing the evaluation models, for generating questionnaires, and for creating evaluation reports.

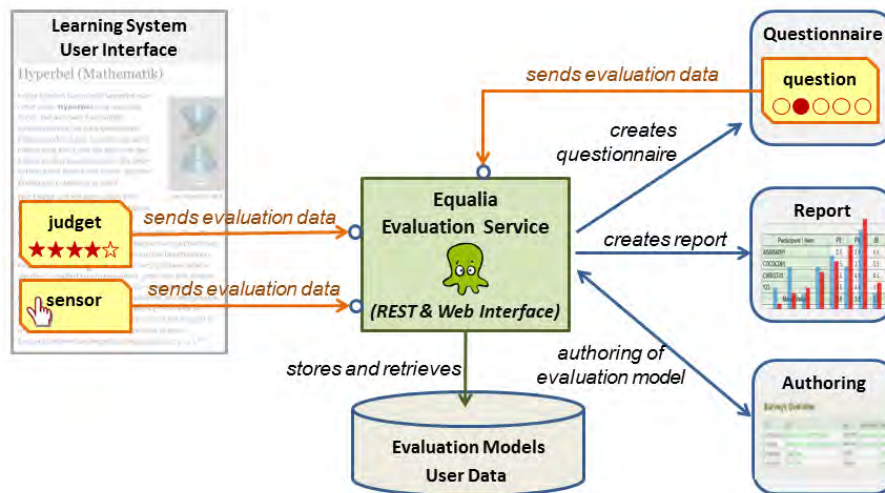

Figure 2: Integration architecture of Equalia with an adaptive learning system.

4. Conclusion and Outlook

This paper presented the evaluation service Equalia that can be used to support the evaluation of adaptive learning systems. Based on the experiences made with this service to evaluate an adaptive digital libraries system, we propose to use it in a similar way for adaptive learning systems. The most important necessary steps include the identification of the qualities to be evaluated, the injection of judget and sensor code (functionality) in the system to be evaluated, and the authoring of the survey model (questionnaires, judget questions, interaction behaviour). Then the evaluation can be conducted more or less automatically.

Acknowledgements

The work reported has been partially supported by the CULTURA project, as part of the Seventh Framework Programme of the European Commission, Area “Digital Libraries and Digital Preservation” (ICT-2009.4.1), grant agreement no. 269973.

References

Brooke, J. (1996). SUS: A "Quick and Dirty" Usability Scale. In P.W. Jordan, B. Thomas, B.A. Weerdmeester & a. L.McClelland (Eds.) Usability Evaluation in Industry, pp. 189-194. London: Taylor & Francis.

Brusilovsky P., Karagiannidis C., & Sampson D. (2004) Layered Evaluation of Adaptive Learning Systems. *International Journal of Continuing Engineering Education and Life-Long Learning*, 14, pp. 402-421.

Cook, J. (2002). *Evaluating Learning Technology Resources*. Retrieved from <http://www.alt.ac.uk/docs/eln014.pdf> on 1 June 2014.

Davis, F. D., Bagozzi, R. P., and Warshaw, P. R. (1989). User Acceptance of Computer Technology: A Comparison of Two Theoretical Models. *Management Science*, 35(8), pp. 982-1003.

Nussbaumer, A., Hillemann, E.-C., Steiner, C.M., & Albert, D. (2012). An Evaluation System for Digital Libraries. In Zaphiris, P. Buchanan, G., Rasmussen, E., and Loizides, F. (Eds.), *Theory and Practice of Digital Libraries*. Second International Conference, TPD 2012. Lecture Notes in Computer Science vol. 7489, pp. 414-419. Berlin: Springer.

Patton, M (1990). *Qualitative Evaluation and Research Methods*. Thousand Oaks, CA: Sage

Steiner, C.M., Albert, D. (2012) Tailor-made or Unfledged? Evaluating the Quality of Adaptive eLearning. In: Psaromiligkos, A. Spyridakos, and S. Retalis (eds.) *Evaluation in E-Learning*, pp. 113-143. New York: Nova Science.

Steiner, C.M., Hillemann, E.-C., Nussbaumer, A., Albert, D., Sweetnam, M.S., Hampson, C., & Conlan, O. (2013). The CULTURA Evaluation Model: An Approach Responding to the Evaluation Needs of an Innovative Research Environment. In: S. Lawless, M. Agosti, P. Clough, & O. Conlan (Eds.), *Proceedings of the First Workshop on Exploration, Navigation and Retrieval of Information in Cultural Heritage*. SIGIR 2013, pp. 39-42. Dublin.

A Shareable Whiteboard System for Distance Collaborative Learning which Enables Instruction for Multiple Groups of Students

Yuichi OHKAWA^{a*}, Kazuki WATANABE^a & Takashi MITSUISHI^{a,b}

^aGraduate School of Educational Informatics, Tohoku University, Japan

^bCenter for Information Technology in Education, Tohoku University, Japan

*kuri@ei.tohoku.ac.jp

Abstract: In order to help collaborative learning with multiple groups of students participating over a network, we developed a shareable whiteboard system that allows a teacher to observe multiple groups simultaneously and provide instruction to specific groups directly. Through an analysis of log files and video recordings, obtained from an experimental lesson, we investigated the effectiveness of the proposed system. Based on these records and a questionnaire survey, we found the proposed system to facilitate the implementation of collaborative learning over a network.

Keywords: Computer-Supported Collaborative Learning, Distance Learning, Collaborative Learning, Shareable Whiteboard

1. Introduction

Collaborative learning—based on the premise of communication among students—is a method of knowledge acquisition that is more effective than conventional learning methods by teacher centered didactic teaching. Therefore, collaborative learning is currently being actively implemented in various educational institutions (e.g., Sugimoto *et al.*, 2002; Kaneko *et al.*, 2007). In addition, collaborative learning using a whiteboard, which is one form of collaborative learning, is expected to facilitate discussions and develop students' imaginations, because students can discuss their ideas using graphics (Obata, 1998; Kobayashi, 2002). Therefore, many past studies have attempted to implement distance collaborative learning using a whiteboard through a network (e.g., Gall and Hauck, 1997). However, there remain several problems that must be solved if we are to successfully implement collaborative learning using a whiteboard through a network.

In order to perform effective collaborative learning, it requires that multiple students participate in the collaborative learning activities. Typically, for these activities, students are divided into multiple groups. When learning begins, the teacher, who oversees the collaborative learning process, needs to simultaneously observe the activities of multiple groups of students and must grasp the progress of each group. Conventional collaborative learning is implemented in one location itself, and the teacher can move among the different groups of students; in this situation, it is not difficult for a teacher to watch the students' learning. However, distance collaborative learning is implemented over a network, in different locations; therefore, it is more difficult to observe multiple groups simultaneously. In addition, teachers may need to intervene in students' activities, either instructing them or imparting advice to specific groups or all groups, as required.

In order to overcome these problems, Koga *et al.* (2002) developed a system by which students can exchange their opinions using text chat and a drawing editor; using this, the teacher is also able to observe the students' learning processes. However, in this system, it was difficult for teachers to observe multiple groups of students simultaneously, since the teachers had to run as many client systems as there were groups. On the other hand, Matsuuchi *et al.* (2010) developed the TERAKOYA learning system according to which the teacher can share his/her screen with the students using an electronic blackboard. Through this system, the teacher was able to intervene in the students' activities. However, this system was not developed for collaborative learning with multiple groups.

In order to achieve an effective collaborative learning system with multiple groups of students over a network, in this study, we developed a shareable whiteboard system using which the teacher could observe multiple groups simultaneously and provide instruction to students. In this paper, we describe the results of an experimental lesson conducted using the proposed system.

2. Intended collaborative learning styles and requirements

2.1 Collaborative learning

The type of collaborative learning targeted in this study is that which can be implemented from remote locations over a network. Students will be divided into multiple groups, and during the learning process, they will draw their ideas on a whiteboard, which will be arranged for each group. Students belonging to the same group will share the ideas they have drawn on the whiteboard. Moreover, they will be able to modify their drawn ideas by exchanging opinions. Then, as a group, they will arrive at a single idea.

The learning activities are aimed not only at knowledge acquisition in a given subject but also at the development of the skills of idea creation and communication.

2.2 System requirements

The system proposed in this study aims to help collaborative learning with multiple students from different locations over a network. Therefore, one of the requirements of the system is that it should be able to divide students into small groups. The system should also be equipped such that students can draw their ideas on the whiteboard; the drawn ideas should then be shared among members of the same group, and the students should be able to exchange opinions regarding these shared ideas.

With regard to the teacher, the system should enable him/her to observe multiple groups simultaneously and provide instruction to each or all groups. We determined that a total of 36 students (6 groups \times 6 students) would be using the proposed system at the same time, which is the maximum number of students one teacher can instruct, based on the premise that the proposed system will be used for higher education.

3. Related studies

We surveyed related studies that aimed at collaborative learning using a shareable whiteboard. We also surveyed previous studies that had used shareable whiteboard systems not only for collaborative learning but also for electronic meetings.

As stated above, Koga *et al.* (2002) developed a collaborative learning support tool for use in distance learning. According to their system, learners can use a drawing editor and text chats to exchange ideas. On the other hand, the teacher can observe and monitor the activities of the learners according to a learning process model that prepared by the teacher beforehand. However, the drawback to this system was that it was difficult to use with multiple groups. Matsuuchi *et al.* (2010) developed the TERA KOYA learning system, a support system for interactive teaching using a shareable whiteboard. This system can transmit pictures and figures drawn by a teacher onto the screens of students' PCs, and the students can make notes on this screen. In addition, the teacher can even write on the students' screens directly. However, this system does not support a collaborative learning scenario that involves multiple groups of students; further, with the TERA KOYA learning system, students cannot hold discussions with others, view each other's screens, or write on their screens. Ito *et al.* (2003) proposed a support system for cooperative working. It allows students to draw pictures on a whiteboard and view texts as the object of the whiteboard linking to the pictures. This system also has a function to output a log in which texts and pictures are recorded along timeline so that students can reflect on their activities after a lesson. However, this system is also not intended to be used for a collaborative learning environment that involves multiple groups. Moreover, this system is not equipped with the function of allowing teachers to intervene in their students' activities for the purpose of delivering instruction. Suzuki *et al.* (2013) developed "edutab," a support system for remote teaching. This system targets for the teaching of the Japanese language in elementary schools. Using this system, a teacher can display texts and pictures on

students' client systems, and students can write on the screens of their clients. The teacher can view the screens of multiple clients at one time and write on the screen of any client, when needed. However, since this system was not designed for collaborative learning, it is not equipped for communication among students. Roseman *et al.* (1996) developed a groupware tool called "TeamRoom." This tool creates virtual rooms in which users can hold meetings from remote locations. Users can also display pictures and text messages and can write on their screens. However, since this tool was not intended to use for the educational purpose, it does not have functions to observe students' activities can be observed across multiple virtual rooms.

4. A system for collaborative learning among multiple groups

4.1 Framework of the proposed system

In order to implement collaborative learning for multiple groups over a network, we are proposing the following system with a shareable whiteboard. Figure 1 shows the framework of the proposing system.

In order to allow a teacher to instruct multiple students in collaborative learning with a shareable whiteboard over a network, our system consists of three sub-systems: (1) a client system for students, which has a whiteboard with multiple pages that students can use for learning; (2) a client system for the teacher, which the teacher can use to observe and instruct students; (3) a server system, using which the teacher and students' client systems communicate with others. We show each sub-system below.

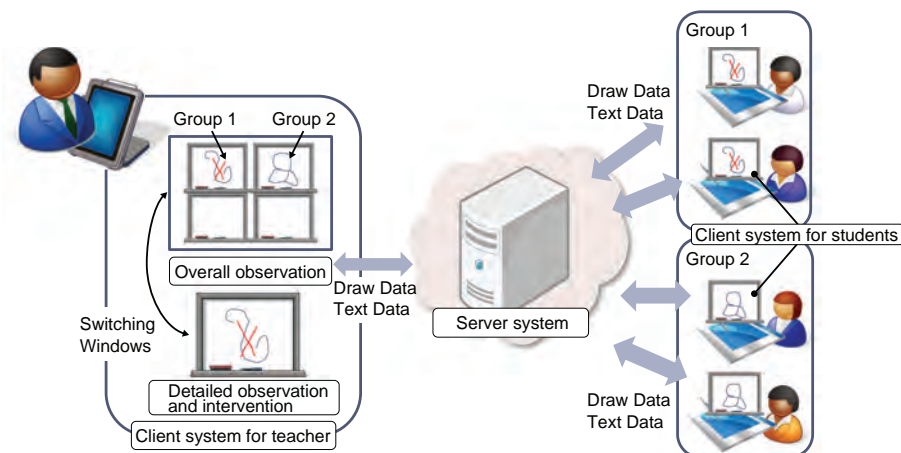

Figure 1. Framework of the proposed system

4.2 A client system for students

The client system for students is equipped with functions for a shareable whiteboard, text chat, and the facility to call the teacher. Figure 2 shows a screenshot of the client system for students, which runs on Microsoft Windows system.



Figure 2. Client system for students

A shareable whiteboard is requisite for students to discuss ideas with members of the same group. Members of the same group share their content on the whiteboard by drawing in the whiteboard area of the client system using specified colors and thicknesses. In addition, the whiteboard has multiple pages that can be turned by clicking on the forward and back buttons. Although the content on each page is shared among members of the same group, as previously described, each page can also be used as a personal space that students can draw on if other members of the group do not use this space. Students of the same group use the text chat function to exchange opinions. Messages—which are inputted by a student into the text box at the lower right-hand side of the client system—are displayed on screens of the other members. Moreover, this chat display can also contain messages from the teacher and other system messages. To distinguish between messages, they are categorized according to color. Therefore, in this system, the teacher can accurately observe and watch the students' learning progress. However, in the case of too many groups, the teacher will not always be able to gather detailed information on the progress of all the groups. If the students have questions to ask the teacher, they can click on the “teacher icon” at the upper right-hand side of the client.

4.3 A client system for teachers

In collaborative learning, it is important for the teacher to provide appropriate instruction to the students; therefore, our client system had the following functions for teachers: the teacher can (1) observe multiple groups of students simultaneously (overall observation); (2) observe individual groups in detail (detailed observation); (3) intervene in the whiteboards of arbitrary groups; (4) manage the members of all groups.

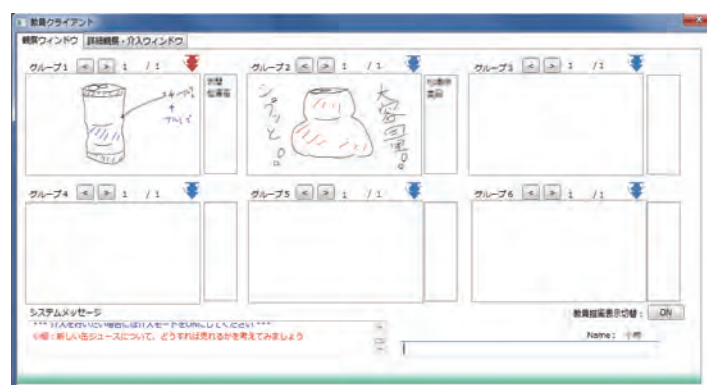

Figure 3. Client system for teachers: an interface for overall observation

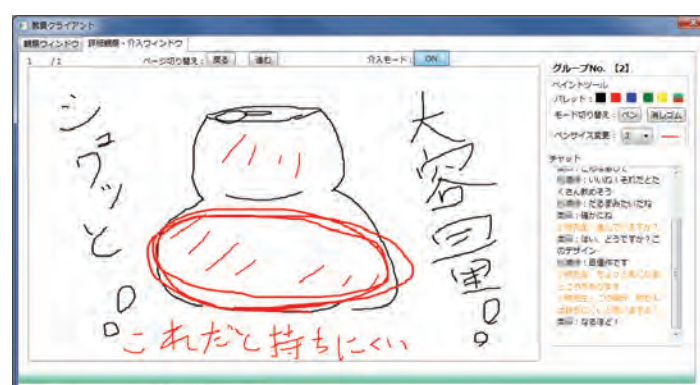

Figure 4. Client system for teachers: an interface for detailed observation and intervention

Figure 3 shows the teacher's interface for viewing multiple groups at the same time (overall observation). As shown in this image, the teacher can observe multiple groups simultaneously by looking at small-sized versions of all the groups' whiteboards in one window. Moreover, the teacher can observe by turning the pages of the whiteboard when there are students who draw on different pages.

The functions for detailed observation and intervention, as shown in Figure 4, enable the teacher to observe a full-scale whiteboard and chat display that are not displayed in the “overall observation” window. The teacher can also provide instruction to students by writing directly on the whiteboard or in

the chat boxes, as necessary. Moreover, if the teacher wants to select one particular group to impart instruction, he/she can click on the reduced-size whiteboard for that group. The management function allows the teacher to manually divide students into groups.

5. The experiment

In order to investigate whether collaborative learning can be implemented using our proposed system, we conducted an experimental lesson.

5.1 The experimental lesson and evaluation methodology

The duration of the experimental lesson was set to 100 minutes, with an interval of 10 minutes between the first and second halves, which were 45 minutes each. The participants comprised five Japanese undergraduate or graduate students in their 20s, with experience in operating PCs. The role of the teacher was played by one of the five participants, who had taken a course in teacher training. The remaining four participants played the role of the students. Taking into consideration the environment suitable for collaborative learning over a network, the participants were assigned to separate rooms to avoid interference, as shown Table 1. A screen separated participants who happened to be placed in the same room. In addition, we made the participants use earphones. To allow students to converse with members of the same group, we set up their PCs with Skype before the experiment. Therefore, students were able to communicate with members of their group through three modes: text chat, the whiteboard of the proposed system, and Skype. To allow the teacher to conduct lessons, we also configured the students' PCs with Ustream, which would deliver video streaming from the teacher. We also equipped the teacher's PC with Skype, in case it was required. Therefore, the teacher could use four modes of communication by which to intervene in the students' activities: text chat; the whiteboard, equipped with the detailed observation function; Skype; and Ustream, which was used for the simultaneous distribution of information. We explained our proposed system to the participants and conducted a trial session in order to make any necessary adjustments to the system before the actual experiment could begin. The entire experiment was recorded by video.

Table 1: Arrangement of rooms and participant grouping

Participants	Teacher	Student A	Student B	Student C	Student D
Assigned Group	—	Group 1		Group 2	
Room	Room 1	Room 2	Room 3	Room 2	Room 3

The subject of the experimental lesson was “an examination of new package designs for drinks.” We planned the experiment with the aim of enabling students to understand that cooperation with other members of the same group is essential by giving them the goal of building a one design; students had to realize this goal by sharing information with each other voluntarily, using the predetermined channels. In order to promote its activities, we confirmed whether the teacher was able to observe the students' activities and provide support. The first 30 minutes of the experiment consisted of the teacher's

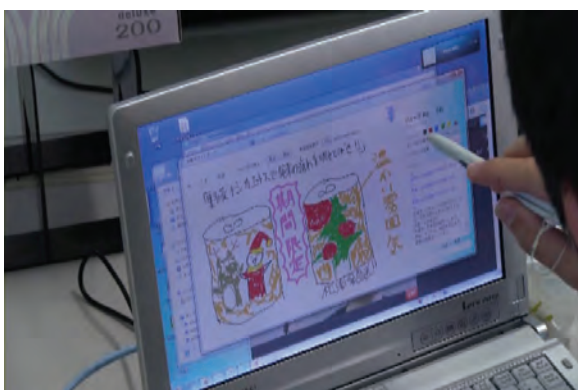

Figure 5. A student using the proposed system

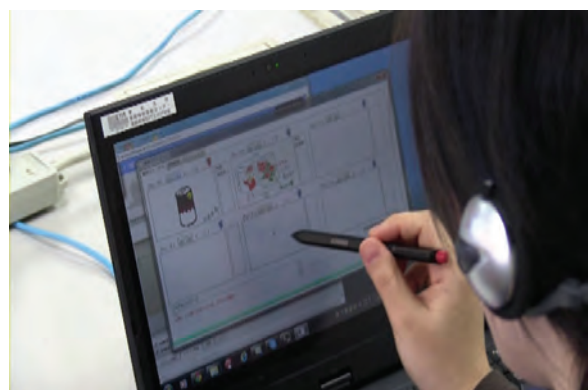

Figure 6. The teacher using the proposed system

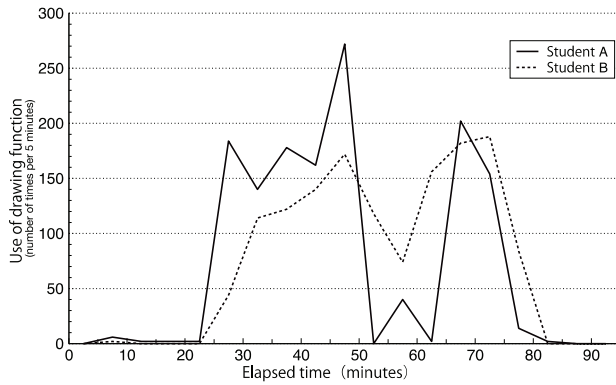

Figure 7. Changes in the use of the drawing function in Group 1

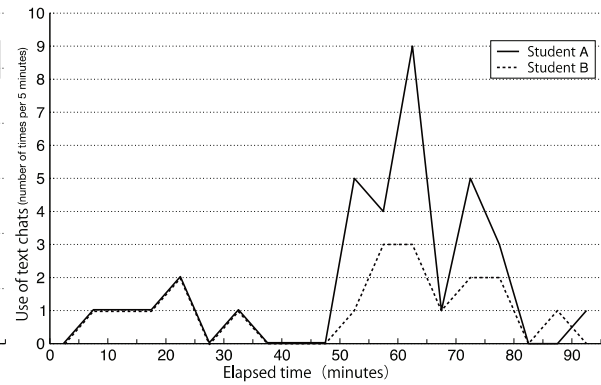

Figure 8. Changes in the use of text chats in Group 1

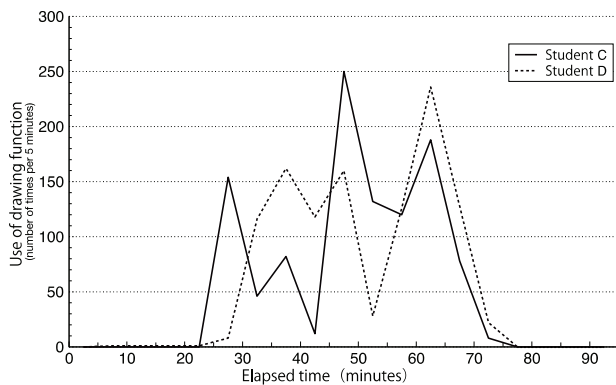

Figure 9. Changes in the use of the drawing function in Group 2

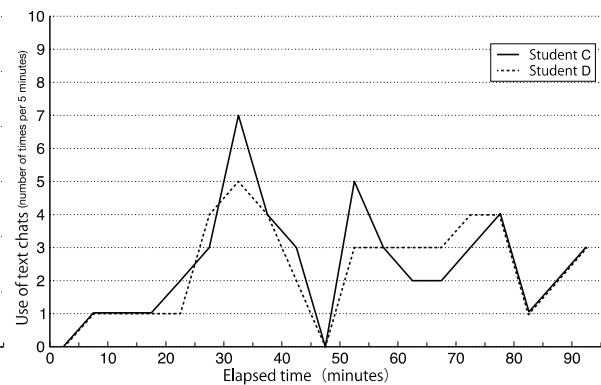

Figure 10. Changes in the use of text chats in Group 2

explanation of premise knowledge for the subject over Ustream. In the next 15 minutes, the students had to draw their ideas on the whiteboard. In the second half of the experimental lesson, 35 minutes were assigned to the students for discussions and for organizing their ideas to arrive at one final idea for the group. In the final 10 minutes, the teacher provided comments and feedback to each group over Ustream. Figure 5 and 6 are pictures of the participants using the system.

In order to evaluate the proposed system, we distributed a questionnaire after the experiment and identified different types of behavior exhibited by the participants at varying times during the experiment by comparing log files with the video recordings. The questions in the questionnaire were based on the following categories (for students): whether the students used the proposed system as a communication tool; whether the students were conscious of the teacher's presence at all times; (for the teacher) whether the teacher could support the students' learning progress by using the functions of overall observation, detailed observation, and intervention; and whether the teacher could impart teaching smoothly. The questions in the questionnaire had a five-point evaluation as well as multiple-choice options; participants were also requested to insert free descriptions.

5.2 Results and evaluation

5.2.1 Behavior of the participants

We analyzed the participant's use of the proposed system by checking the logs of the drawing function and the text chats for each group and comparing these with the video recording.

(1) Behavior of the students

Figure 7 and 8 show the changes in the number of text chats and the use of the drawing function in Group 1 every 5 minutes. In Group 1, there was an inverse relationship between the number of text chats and the use of the drawing function: there was a decrease in text chats and a corresponding increase in the use of the drawing function.

For example, there was a rapid increase in the number of text chats between 50 and 55 minutes, as shown in Figure 8. From the recorded video, we found that at 43 minutes and 42 seconds, the teacher instructed each group over Ustream to begin their discussions; at 50 minutes and 07 seconds, Student A from Group 1 requested to start discussions with Student B, and they started their discussion. We believe this to be the reason behind the decreased use of text chats.

Figure 9 and 10 show the changes in the use of text chats and the drawing function in Group 2. Unlike the case with Group 1, in Group 2, both the drawing function and text chats were used at the same time, as seen from these figures; we believe that in this group, the students were drawing their ideas on the whiteboard while simultaneously engaging in a discussion via text chat. However, between 45 and 50 minutes, the use of text chats, which thus far had been used continuously, suddenly disappeared and was replaced by an increased use in the drawing function. We believe this was because at 43 minutes and 01 seconds, Student C from Group 2 proposed a concrete design to Student D, and in response, both the students started drawing on the whiteboard.

Although the students had the option of communicating within the group using Skype voice calls, none of the students used this medium; they exclusively used text chats and the whiteboard for communication.

(2) Behavior of the teacher

We analyzed how the teacher observed the learning activities of multiple groups. Figure 11 depicts a graph of the duration at which the teacher observed each group in detail or intervened in the activities of those groups.

In this experiment, the teacher began to use the proposed system after 9 minutes and 44 seconds. Therefore, we recorded the durations at which the teacher observed each group in detail after 10 minutes from the start of the experimental lesson. In the following 10 minutes, the teacher requested the students for the use of text chats in response to the teacher's lesson; the teacher also checked the students' text messages while switching between groups frequently.

Figure 11 shows that the highest duration of time that the teacher observed each group in detail was between 30 and 45 minutes. From the recorded video, we found that the teacher spent more time observing Group 2 from minutes 30–35 and spent more time observing Group 1 from the minutes 40–45. From the recorded video, we noticed that the teacher was checking to ensure the success of each group while simultaneously checking the text chat logs. We also believe that the teacher observed each group in detail for a longer duration, because the number of ideas being drawn on the whiteboard was increasing toward the end of the first half of the lesson.

From the recorded video, we could see that the teacher called for a break for less than 10 minutes, from 40 minutes and 45 seconds to 50 minutes and 08 seconds. Therefore, at the elapsed time of 45–50 minutes, the teacher observed each group in detail for less than 50 seconds. On the other hand, the students continued their learning activities even though the teacher was not virtually present.

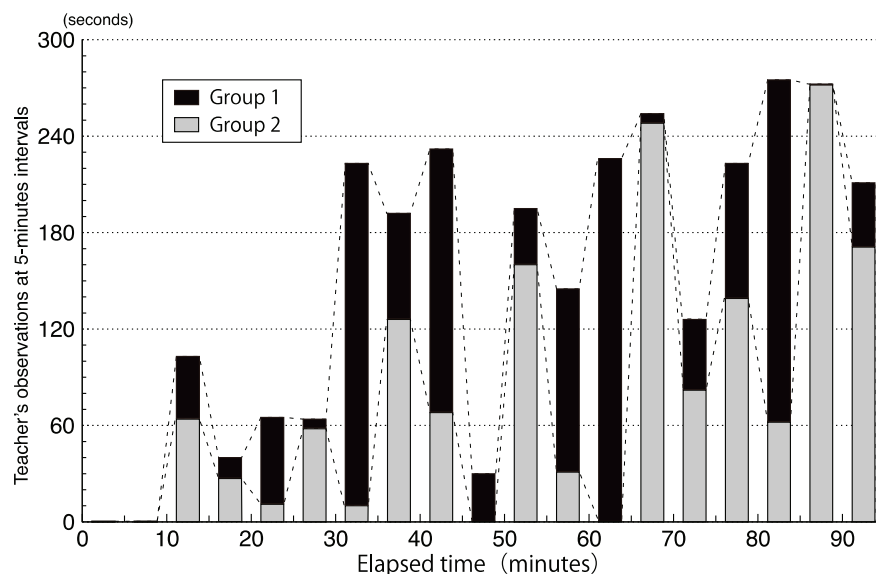

Figure 11. Durations at which the teacher observed each group in detail or intervened

At the elapsed time of 60–65 minutes, the teacher observed Group 1 in detail for longer than 200 seconds, but the duration that the teacher observed Group 2 was much shorter. This is because the teacher intervened in Group 1’s activities by drawing directly on the whiteboard from 62 minutes and 16 seconds to 64 minutes and 48 seconds. On the other hand, at the elapsed time of 65–70 minutes, the teacher observed Group 1 in detail for a very short time. We found that the teacher intervened in Group 2’s activities by drawing on the whiteboard from 68 minutes and 22 seconds to 69 minutes and 40 seconds.

From Figure 11, we can see that at the elapsed time of 70–75 minutes, the teacher observed each group in detail for a short amount of time. Since the teacher observed the students—using the overall observation function—from 70 minutes and 29 seconds until 72 minutes and 23 seconds, the teacher did not have much time to use detailed observation at this time. In contrast, after the elapsed time of 80 minutes, the teacher observed each group in detail for a longer time. It is because the teacher commented on and displayed the outcomes of each group over Ustream.

Although the teacher could use Skype voice calls to communicate with either group, the teacher did not do so. If the teacher needed to communicate with both groups simultaneously, Ustream was used; when the teacher had to communicate with specific members of either group, text chats were used.

5.2.2 Evaluation by the participants

(1) Evaluation by the students

Table 2 shows the results of the questionnaire survey conducted for the students. The first three questions pertained to whether the proposed system could support students as a communication tool. The results showed that the students gave high ratings for both the shareable whiteboard and the text chat function. Based on opinions such as “it’s useful” and “it’s convenient,” elicited from the free description section of the questionnaire, we can say that the proposed system was considered a useful communication tool for collaborative learning.

The next four questions pertained to whether the students were able to focus on collaborative learning with the constant presence of other students and the teacher. The results revealed a few affirmative answers, such as “agree,” and some neutral answers, such as “undecided.” For example, 50% of the students responded that they were “undecided” about whether the constant presence of the teacher made them feel tense or relieved. Since the teacher mentioned that he/she could observe the students’ learning activities and comment on them several times during the experimental lesson, we thought that the students would be conscious of being constantly observed by the teacher. However, the students did not feel as tense and relieved as we expected.

Table 2: Results of the questionnaire for students (N=4); the 5–1 scale corresponds to “agree,” “moderately agree,” “undecided,” “moderately disagree,” and “disagree.”

Questions	Answers (number of persons)					Mean
	5	4	3	2	1	
You could express your opinion through the whiteboard	3	1				4.7
You could ascertain others’ opinions through the whiteboard	2	2				4.5
It was helpful to exchange opinions using text chats	3	1				4.7
You were able to focus on collaborative learning with the presence of the teacher and other students	2	2				4.5
You were able to learn even though you felt tense and relieved because of the teacher’s observations		2	2			3.5
You could recognize the quality of the activities because of the teacher’s direct instructions		4				4.0
It is necessary to cease operations while the teacher is instructing you directly	1	1	2			3.8

When the students were asked whether it was fitting for them to stop drawing on the whiteboard while the teacher intervened, none of the students said they “disagreed”; however, their answers ranged between 3 and 5. We think this is because those students misunderstood the intervention as a system malfunction, and they did not notice that the teacher had actually intervened. From the recorded video, we noticed that while some students paid careful attention to the teacher’s intervention, there were others who did not even notice that the teacher had intervened; they continued to operate the system (for example, turn pages). Based on this finding, we believe that, in the future, it will be necessary to investigate how a teacher can intervene and manage his/her students’ operation of a system, and how a system can be configured such that a student gets a notification whenever a teacher intervenes.

In the free description section of the questionnaire, one of the students commented that the function for voice communication was not built into the proposed system. This student was unable to talk to the teacher via Skype when the teacher does not operate to connect with the Skype even if the student wanted to communicate with the teacher. Therefore, we thought that the students found it inconvenient to use the different means of communication, which could be why they did not use Skype voice calls.

(2) *Evaluation by the teacher*

Table 3 shows the results of the questionnaire from the perspective of the teacher. We found that the proposed system received high scores, overall. However, the teacher gave a low score for the question on whether it was helpful that the students cease operation when the teacher intervened. Further, in the free description section of the questionnaire, the teacher provided the following feedback: “Students could not draw on the whiteboard during my intervention (I was worried about students’ time constraints).” Since the students were not allowed to operate the system while the teacher intervened, we believe that the teacher hesitated to intervene and stop the students’ activities, considering their time constraints.

Table 3: Results of the questionnaire for the teacher (N=1)

Questions		Answers
Overall observation	The system helped you grasp the learning progress of multiple groups	4 (moderately agree)
	The text chat function, by which you could transmit messages to all groups simultaneously is necessary	4
Detailed observation and intervention	The system helped you grasp the learning progress of specific groups	4
	Joining the text chats of specific groups was helpful to grasp their learning progress	5 (agree)
	You could advise students on procedures related to their learning	4
	You could instruct students on issues related to the content	4
	The fact that students had to cease operations while you gave instructions was helpful	2 (moderately disagree)

6. Conclusions

In this study, we developed a shareable whiteboard system for use in collaborative learning, whereby a teacher could observe multiple groups simultaneously and provide instruction from a remote location over a network. The developed client server system consisted of a client system for students, a client system for teachers, and a server system for management. The client system for students was equipped with a shareable whiteboard. Moreover, the client system for teachers allowed the teacher to observe and provide instruction to multiple groups simultaneously.

In this study, we conducted an experiment using the proposed system and acquired usage log files and video recordings. Based on these records, we found that the students were successful in collaborative learning. In addition, we also found that the teacher could instruct students in three ways: through overall observation, detailed observation, and intervention, where required. Further, the

participants responded positively to the questionnaire. Therefore, we believe that the proposed system works favorably for collaborated learning.

In terms of drawbacks, we found that the proposed system did not have adequate functions such as voice chat, exchange of information among other groups, and controlling permission of drawing. If we were to overcome these drawbacks, we believe that the proposed system would be very valuable. Yet another drawback is the sample size. In this study, we conducted the experiment using only five participants. This number is not large enough to be representative of a larger sample. We should note that there are various forms of collaborative learning other than the type used in this study. Therefore, by way of further study, we would like to investigate the proposed system in different lesson with a larger number of participants.

Acknowledgement

This work was supported by JSPS KAKENHI Grant Numbers 23501092 and 24700884.

References

- Sugimoto, M., Kusunoki, F., Inagaki, S., Takatoki, K., Yoshikawa, A. (2002). A system for supporting collaborative learning with networked sensing boards. *The IEICE Transactions on Information and Systems*, J85-D-I(12), 1152-1163. (in Japanese)
- Kaneko, D., Noboriguchi, Y. (2007). A development of peer review and group learning system and its application to basic ICT education. *Japan Journal of Educational Technology*, 31(Supple.), 33-36. (in Japanese)
- Obata, A. (1998). Video and shared whiteboard effects on remote cooperative work. *Journal of Information Processing Society of Japan*, 39(10), 2752-2761. (in Japanese)
- Kobayashi, K. (2002). Co-constriction of evaluation process internalized in classroom discourse. *Bulletin of the Education Faculty, Shizuoka University. Liberal Arts and Social Sciences Series*, 52, 279-292. (in Japanese)
- Gall, U., Hauck, F.J. (1997). Promondia: A Java-based framework for real-time group communication in the Web. *Computer Networks and ISDN Systems*, 29, 917-926
- Koga, A., Nishiyama, H., Tanaka, T., Hirose, M. (2002). Development of learning process authoring tool and learning environment for collaborative learning. *The FY 2001 Project Reports Rev.2*, IPA Japan. (in Japanese)
- Matsuuchi, N., Nishiuchi Y., Shiba, H., Yamaguchi, T., Mendori, T. (2010). TERAKOYA learning system linking multipoint remote users for supplementary lessons. *Information and Systems in Education*, 9(1), 35-44.
- Ito, K., Sakai, S., Akahori, K. (2003). Development and education of shared whiteboard for supporting collaborative learning. *Japan Journal of Educational Technology*, 27(Supple.), 77-80. (in Japanese)
- Suzuki, S., Mizukoshi, K., Fukazawa, M., Yatsushiro, K., Torikai, E. (2013). A proposal of connection method and evaluation of a distance learning support system built on the network between schools. *IPSJ Journal*, 54(3), 1050-1060. (in Japanese)
- Roseman, M., Greenberg, S. (1996). TeamRooms: Network places for collaboration. *Proc. of Computer supported cooperative work '96*, 325-333.

Improving 10-12 Year Olds' Epistemic and Conceptual Understanding in a Computer-supported Knowledge-building Environment

Feng LIN^{a*}, Carol K.K. CHAN^a

^a*Faculty of Education, The University of Hong Kong, Hong Kong*

*irisfeng83@gmail.com

Abstract: This study investigated the design of a computer supported knowledge-building environment in fostering 10-12 year olds' epistemic and conceptual understanding. Two classes of 5th graders in Guangzhou China participated in this study while they were learning a unit about electricity. One class engaged in knowledge building, supported with a computer supported platform--Knowledge Forum®, and the other class was taught with traditional approach for comparison. The results showed significantly stronger effects on epistemic view of science and conceptual understanding for knowledge-building group compared with the traditional group. Regression analysis showed that knowledge-building environment and post epistemology of science contributed to students' post scientific understanding, over and above their prior science knowledge. Qualitative analysis of students' Knowledge Forum discourse and interviews showed how the design had helped improve students' epistemic view on the social and progressive nature of scientific inquiry and conceptual understanding.

Keywords: Knowledge building, epistemic view of science, conceptual understanding, CSCL

1. Introduction

The research on the design of computer-supported collaborative learning (CSCL) environment has received much attention in the recent years. Studies have been conducted to investigate the effectiveness of CSCL on students' conceptual change, inquiry process, and other cognition and skills (Liu & Hmelo-Silver, 2007; Tao & Gunstone, 1999; Vosniadou & Kollias, 2003; Hakkarainen, 2003; Lazakidou & Retalis, 2010; Salovaara, 2005). However, very few have been conducted to examine its effect on students' epistemic view of science (Chan & Lam, 2010). Sophisticated epistemic view of science is important as part of students' scientific literacy. Researchers have proposed different ways to conceptualize epistemic view of science. This study built on the line of research that examined students' epistemic view of science from the role of idea and theory building perspective (Carey, Evans, Honda, Jay, & Unger, 1989; Carey & Smith, 1993; Chuy et al., 2010; Smith, Maclin, Houghton, & Hennessey, 2000), and extended it to examine students' understanding about the social aspect of the theory building process in science. Previous research has shown that many students have naïve epistemic view, and they regard science as concrete activities rather than idea-driven process (Carey et al., 1989; Smith et al., 2000). Therefore, the current study is trying to design a computer-supported knowledge-building environment to improve students' epistemic view of science, and to help them understand the role of idea in science, and the collective and progressive nature of scientific inquiry.

2. Theoretical Background

2.1 *Epistemic View of Science*

Improving students' understanding about the nature of science has always be the focus of science education. Some science educators have proposed to examine students' nature of science views from

seven aspects: tentative nature of science, empirically based nature of scientific knowledge, subjective nature of science, science involving human inference, imagination, and creativity, the relation and distinction between scientific laws and theories, and observation and inferences (Lederman, Abd-El-Khalick, Bell, & Schwartz, 2002). It has been argued that even these seven aspects did not capture the whole nature of science, they were accessible to students and were well recognized by scientists and science educators (Lederman et al., 2002). Some other researchers have followed the psychometric tradition initiated by Perry (1970), Schommer (1990), and Hofer and Pintrich (1997), and examined students' epistemological beliefs on science on four dimensions: development of knowledge, certainty of knowledge, justification for knowing, and source of knowledge (Conley, Pintrich, Vekiri, & Harrison, 2004).

Even though these approaches have portrayed the important aspects of the nature of science, the constructive nature of science was still neglected. Premised on constructivism paradigm, Carey et al. (1989) initiated a line of research that examined how students understand science as an idea driven process. Smith et al. (2000) and Chuy et al. (2010) further contributed to the line of research by elaborating on the specific components of the nature of science and making theory building more explicit. This study followed this line of research and examined students' understanding about the nature of science from the role of idea perspective. Meanwhile, we also tried to extend beyond it by focusing on the social aspect, to examine how students understand science as a collective theory building process, which involves negotiation of ideas, co-construction of ideas, and integration and creation of ideas.

2.2 Computer Supported Knowledge Building

Knowledge building is one of the inquiry based educational models focusing on knowledge creation and theory building. The central idea of knowledge building is about students taking epistemic agency and taking collective cognitive responsibility to advance the community knowledge (Scardamalia, 2002). To support students' knowledge building effort, Knowledge Forum®, a computer supported learning platform, has been created. It provides students with a multimedia community knowledge space where their ideas can be displayed, linked, built on, revised, and integrated (Scardamalia, 2004).

The design of knowledge building environment and its relation to students' learning outcomes has been examined by a growing number of studies (Chan, 2009; Lee, Chan, & van Aalst, 2006; Zhang, Scardamalia, Lamon, Messina, & Reeve, 2007; Zhang, Scardamalia, Reeve, & Messina, 2009). Scardamalia and Bereiter (2006) have been advocating that the goal of knowledge building is not to evolve into a series of procedures, but a pedagogy guided with workable principles. 12 principles have been proposed to guide knowledge building practice (Scardamalia, 2002), including real ideas, authentic problems, improvable ideas, idea diversity, rise above, epistemic agency, community knowledge, collective responsibility, democratizing knowledge, constructive uses of authoritative sources, etc.

To sum up, the purpose of this study is to examine the design of knowledge building environment on students' epistemic and conceptual growth. Three research questions were addressed: (1) Do students engaging in knowledge building achieve more epistemic and conceptual growth than students in traditional classroom? (2) What are the relationships among knowledge building, epistemic view of science, conception of collaborative discourse, and conceptual understanding? (3) How does knowledge building help students improve their epistemic view of science and conceptual understanding?

3. Method

3.1 Participants and Context

Two classes of 10-12-year-old 5th graders (n=61) in Guangzhou China participated in this study. One was engaged in computer-supported knowledge building inquiry, supported with Knowledge Forum; another one was taught with traditional approach for comparison. Students were learning a unit about electricity while we conducted the intervention. Both classes were taught by the same science teacher,

who was experienced in science teaching and just started to learn knowledge building pedagogy. The whole intervention lasted for 3 weeks and was implemented in 6 sessions.

3.2 Designing Computer Supported Knowledge-building Environment

The knowledge building class was designed with knowledge building pedagogy and was mainly guided with four knowledge-building principles, “improvable idea”, “epistemic agency”, “constructive use of authoritative information”, and “community knowledge”(Scardamalia, 2002). The key idea of the design was about letting students pursue inquiry like scientists community. They posted their questions and ideas on Knowledge Forum, tested their ideas with experiment, and continued to revise and improve their ideas on Knowledge Forum. The specific design was described below:

(1) Initiate inquiry on Knowledge Forum. The first two classes were conducted in the computer room. After trying out the Knowledge Forum function in a demo view, students were asked to put their questions and ideas on the electricity view. We did not teach them how to respond to each other, but let them try out and figure out themselves. However, they were encouraged to use the scaffolds in their notes writing: “I need to understand”, “my theory (explanation)”, “new information”, “a better theory (explanation)”, “your theory cannot explain”. This session was mainly designed to put students’ ideas in the public place as subject to build on, and to let them get familiar with the Knowledge Forum functions.

(2) Reflect on Knowledge Forum discourse. After letting students experience the discussion on Knowledge Forum themselves, we designed a session on “what is good discussion”, so that they could reflect on the quality of their own discussion. We prepared two threads of notes, one was from their own Knowledge Forum discussion, and another one was from a primary science database in Hong Kong, which was chosen as a good model. We let students compare these two threads of notes and choose a better one. Then we let them discuss in groups and write down on poster why they think the chosen one was a better discussion. To nurture a knowledge-building culture in the classroom, students were asked to put their group poster on blackboard, and then everyone could write a note to comment and put the notes on the posters. This was designed to simulate the threads on Knowledge Forum and to let students aware that their ideas could be made in public and improved by the community. At the end of the session, the teacher related students’ collective ideas on the criteria of good discussion to knowledge building principles, and encouraged them to use these principles to guide their later Knowledge Forum discussion.

(3) Deepen inquiry. To make students have a more focused discussion, a deepening view was created, as Figure 1 shows. Many students were interested in the discussion on whether wet wood conducts electricity. They proposed different ideas and theories to explain the conductivity of wet wood. Then they were asked to work in groups to design experiment to test their own ideas. After students completed their designs, each group presented their design poster in the classroom, and put it on the blackboard for further improvement. Again students were asked to write notes to comment on the designs and stuck it on the poster, as Figure 2 shows. To make the classroom knowledge-building look as similar as the Knowledge Forum one, and also to make them aware of the connection between their classroom ideas and Knowledge Forum ideas, we put their Knowledge Forum question in the middle of the blackboard, and drew lines between students’ experiment designs and this question (Figure 2). It was hoped that this design could help students understand the role of idea in experiment. After the experiment, students were encouraged to continue to write on Knowledge Forum.

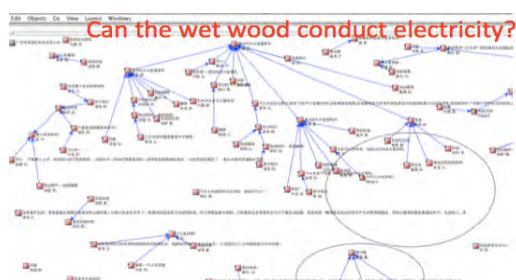

Figure 1 Deepening view on electricity



Figure 2 Visualize KF ideas in classroom

(4) Reflect on science learning and nature of science. At the end of the program, students were asked to reflect on their changed epistemic and conceptual understanding. They were asked to write in a piece of paper on “what I knew about electricity before, what are the new understanding I have now about electricity; what I knew about the nature of science before, what are the new understanding I have now about nature of science”.

The comparison class was also learning electricity but was taught with traditional approach. According to the teacher interview, in each class, he usually lectured first according to the textbook, and then would let students discuss among themselves. No scaffold was provided.

3.3 Measures

Written Test on Epistemic View of Science. Pre and post written test on epistemic view of science were given to all students to fill out before and after the program. The written test consisted of 7 items adapted from Carey, et al. (1989), Smith et al. (2000), Chuy et al. (2010), Conley et al. (2004), and Lederman & Ko’s (2004) items. Students were given 20-30 minutes to finish the test. Four components were identified to characterize students’ epistemic view of science: (1) Role of idea (“What is science”; “What do scientists do”; “How do scientists do their work”; “Why do you think scientists do experiment”); (2) Theory building (“How do you think new theory is developed”); (3) Theory-fact understanding (“What are the relationships between theory and fact”); (4) Social process of scientific progress (“Scientists may have different even contradictory ideas, do you think it is good for science?”).

Premised on knowledge building theory, students’ responses were coded on a 3-point scale, ranging from viewing science as concrete activities to collective theory building process. Take an item on role of idea for example, at level 1, students do not understand the role of idea in science, they only mention some concrete activities scientist do, such as work in the lab, mix things together, and invent things (“*scientists do experiment in the lab*”; “*they pour tubes in the lab*”); at level 2, students mention some abstract entity, such as theory, question, explanation, hypothesis, and laws, etc, and they also have some understanding about the connection between idea and experiment (“*They propose some ideas, and do experiment to prove*”); at level 3, students can make the connection between the abstract ideas and experiment, and also mention about the social aspects of science and knowledge creation (“*Scientists do experiment, questioning, propose new ideas, test ideas, and get conclusions*”). For the component on social process of scientific progress, at level 1, students do not appreciate the role of different ideas for scientific progress, or have some superficial understanding of the role of different ideas in science (“*It is a good thing, because it will improve scientists’ hard working spirit*”); at level 2, students appreciate of the role of idea interaction for science, (“*It is a good thing, because new evidence may come out from the argument*”); at level 3, students understand the role of different ideas for theory improvement/knowledge creation (“*it is a good thing, if everyone has the same idea, there won’t be better ideas. When we combine different ideas, there will be a even better idea*”).

Interviews. Interviews were conducted before and after the program to examine students’ epistemic change process. Eight students from each class were recruited for the interview. The first part of the interview asked similar questions as the written test to have deeper understanding about students’ epistemic views; the second part of the interview asked how students have changed their epistemic view and conceptual understanding about electricity.

Knowledge Test on Electricity. A knowledge test was designed to measure students’ conceptual understanding on electricity. The first part contained close-ended questions asking whether certain material (e.g., metal, lemon juice, graphite, distilled water, etc.) conducts electricity, the second part included open-ended questions asking students to explain the conductivity of different material, e.g., why do some material conduct electricity, and some do not? The first part of the test was scored according to the correctness of answers and the second part was coded based on scientificness of ideas (Zhang, et al., 2007). Both parts of the test were transformed into percentage score and were averaged into an overall conceptual understanding score.

Knowledge Building Engagement. Students’ performance on Knowledge Forum was measured with a software Analytic Toolkit (ATK) developed by the Knowledge Building Research Team at the University of Toronto (Burtis, 1998). ATK could provide us quantitative measures such as number of notes created, percentage of notes linked and read, number of notes with scaffolds or keywords, etc.

We selected two measures: number of notes write and percentage of notes read to represent students' knowledge building participation and knowledge building awareness.

Conception of Collaborative Discourse. Students' conception of collaborative discourse was measured with an open-ended written test containing an item on "what is good discussion". Students were asked to fill out this test at the end of the program. A 3-point scale coding scheme was developed to capture the patterns of understanding. At level 1, students only focus on the behavioral aspects of discussion (e.g., "try our best to discuss"; "people discuss carefully"); at level 2, students mention about the importance of diverse ideas, questioning, or using new information for good discussion (e.g., "There are different ideas, questioning...in a good discussion."); at level 3, students understand that a good discussion is a progressive and deepening process, involving questioning, emerging ideas, building on, and idea improvement (e.g., "I think a good discussion should be like this: propose questions, answer the questions, different suggestions to the ideas/new understanding about the ideas, build on the previous ideas and make a even better idea. It keeps circulating.....")

4. Analysis and Results

4.1 Effects of Knowledge Building on Epistemic View of Science

To examine the effects of knowledge building on students' epistemic view of science, a 2 x 2 (group x time) repeated measure MANOVA was conducted for all four components; the mean and standard deviation (SD) were presented in table 1. Results revealed statistically significant multivariate effects. The following univariate ANOVA showed significant main effect for time for role of idea $F(1, 59)=7.459, p=.008, \text{Partial } \eta^2=.112$, suggesting that both classes improved over time on role of idea. There was also a significant main effect for group for role of idea $F(1, 59)=6.987, p=.011, \text{Partial } \eta^2=.106$, and theory building $F(1, 59)=6.393, p=.013, \text{Partial } \eta^2=.100$. Importantly, significant time x class was found for theory-fact understanding $F(1, 59)=4.33, p=.042, \text{Partial } \eta^2=.068$, and social process $F(1,59)=4.104, p=.047, \text{Partial } \eta^2=.065$. This indicated that knowledge building class improved more on their epistemic view on theory-fact understanding and social process of scientific progress than did the comparison class.

Table 1: Pre and posttest mean scores (SD in parentheses) in epistemic view across classes

	Knowledge building class(n=39)		Comparison class(n=22)	
	Pre-test	Post-test	Pre-test	Post-test
Role of Idea	1.24(.43)	1.39(.51)	.98(.31)	1.14(.34)
Theory-Fact	1.26(.72)	1.62(.75)	1.45(.60)	1.37(.49)
Theory Building	1.59(.64)	1.92(.87)	1.45(.51)	1.36(.49)
Social aspect	1.49(.76)	1.79(.73)	1.64(.66)	1.55(.51)
Epistemic overall	5.57(1.75)	6.72(2.13)	5.52(1.27)	5.41(.94)

4.2 Effects of Knowledge-building on Conceptual Understanding

Repeated measure ANOVA was conducted to examine the intervention effect on students' conceptual understanding. The mean and Standard Deviation of the pre and post conceptual understanding scores is .59(.08) and .70(.13) for knowledge building class, and .55(.07) and .59(.54) for regular class. The results showed significant main effect for time, $F(1,57)=21.05, p=.000, \text{Partial } \eta^2=.27$, suggesting that both groups have improved their conceptual understanding over time. There was no main effect for group. Significant time and group interaction, $F(1,57)=4.08, p=.04, \text{Partial } \eta^2=.07$, indicated that knowledge building group improved more on their conceptual understanding on electricity than did the comparison group.

4.3 Relationship among Epistemic View of Science, Conceptual Understanding, Understanding of Collaborative Discourse, and Knowledge Building Engagement

Correlation analysis was conducted within knowledge building group (n=39) (see table 2). Results showed that students' post epistemic view was correlated with their conception of collaborative discourse, Knowledge Forum awareness, and post conceptual understanding. It also showed that students' conception of collaborative discourse was significantly correlated with post conceptual understanding and Knowledge Forum awareness.

Table 2. Correlation among post overall epistemic view, post conceptual understanding, KF participation and awareness, and conception of collaborative discourse (n=39)

	Post epistemic	Post conceptual	Conception of discourse	KF participation	KF awareness
Post epistemic	1				
Post conceptual	.611**	1			
Conception of discourse	.677**	.417*	1		
KF participation	0.113	0.021	0.325	1	
KF awareness	.363*	0.212	.591**	.641**	1

Note: *p<.05; **p<.01

Hierarchical regression (see table 3) was conducted for the both group (n=61), first entering prior science knowledge (prior conceptual understanding and academic science score), followed by pre epistemic view, and then learning context. Learning context was coded into two variables (Knowledge building group=1; comparison group=0). Results showed that prior science knowledge explained 12.6% of the variance, when pre epistemic view was added, additional 18.0% of the variance was explained. When learning context was added, additional 10.8% of the variance was explained. This indicated that over and above prior science knowledge, epistemic view and knowledge building context further contributed to post science knowledge.

Table 3. Hierarchical regression on post conceptual understanding with prior science knowledge, pre epistemic view, and learning context (n=61)

	R	R ²	R ² Change	F Change	Sig.
Prior science knowledge & academic science score	.355	.126	.126	4.043	.023
Pre epistemic view	.554	.307	.180	14.317	.000
Learning context	.644	.414	.108	9.910	.003

5. The Epistemic and Conceptual Change Process

5.1 Changed Epistemic Practice on Knowledge Forum

To understand how students changed their understanding of the social process of scientific progress, we examined how they have experienced this aspect of inquiry in knowledge building. Therefore we examined students' collective discourse on Knowledge Forum, which was the place they might experience the social aspects of the inquiry. Meanwhile, interviews and classroom observation were also used to triangulate and enrich findings from the discourse data.

The knowledge-building students wrote 202 notes in total, and much of the notes were written during the class. Examination of students' earlier notes on Knowledge Forum showed that, students posted many fact-seeking or definition seeking questions in the beginning (e.g., "*can rubber conduct electricity*", "*what is conductor*", etc. they also answered some of these questions with intuitive opinions or undigested information from Internet. For example, a student asked: "*can we see electricity?*", another student responded and said: "*we can not see it*". No more response followed. Another example is, a student asked, "*what is conductor*", another student copied a definition from the textbook and said: "*conductor is a substance that conducts electricity*", that was the end of the discussion. These excerpts indicated that in the beginning students might regard scientific inquiry as a one-question-and-one-answer type of activity.

After the class on what is good discussion, students seemed to be more awareness of the progressive nature of inquiry and their discourse pattern started to shift in more sustained one. For example, student A initiated a question about whether electricity is hot, student B responded and said “[my explanation/theory] when electricity pass through the conductor, it will generate heat, because of the existence of resistance”, the teacher further prompted: “[I don’t understand] why does it generate heat when there is resistance?”, Student C further explained and said: “[my explanation/theory] when the free electron moves in certain direction with the electric force in the conductor, it keeps bumping on metallic ions, and transforms the energy into the ions. Therefore the ions moves more intensively, and cause the heat...”. This example showed how teacher scaffolded students to sustain the inquiry, and how students built on each other, and incorporated new information to address the problem and to deepen their understanding.

The most sustained thread was the one about wet wood conduct electricity. 44 notes had addressed and built on this problem. Students proposed different ideas and theories to explain the conductivity of wet wood. Some said that it couldn’t conduct electricity; while others said “it can, because water can conduct electricity”. A student further explained, “the dry wood originally does not conduct electricity, however, after it was wet by the water, some of the impurity of the wood dissolved into water, the water is no longer pure any more, and can therefore become conductive. It is the water that conduct electricity, but not the wood”. As described in the instructional design session, to test these ideas, students designed experiment in groups. They found that dry wood could not conduct electricity, running water was a little bit more conductive, and salt water was most conductive. They started to wonder why salt water was more conductive and whether different kinds of water had different conductivity. Therefore they posted their emerging questions on Knowledge Forum again for further inquiry. This example showed that students’ discourse pattern had started to shifted into more sustained one that reflected the progressive and emerging nature of inquiry.

5.2 Interpretation of the Epistemic Design of Knowledge Building

Qualitative analysis of students’ interview transcripts indicated that how students interpret the design and their inquiry process might have influenced how they understand the nature of science, as the following excerpts illustrates:

I(interviewer): what are the new understandings you have about the nature of science after the knowledge building?

Students Q: Develop new theory out of the existing theories.

I: How?

Student Q: If you discover a new problem, you can make an inference about the result of the problem according to existing theories.

I: Why do you think like that?

Student Q: Because science itself is a circulating process. After you solve a problem, you find another new problem, then you solve it and you find another new problem, it keep circulating.

I: when did you start to think like this?

Student Q: After the computer (Knowledge Forum) class

Student M: Because in the first beginning we pose some questions and ideas in the initial view about electricity, later another new deepening view about electricity was created where we found the questions we posed earlier, and we raised more questions building on the responses of the original questions.

It showed that these students have made the connection between their understanding about the “ever deepening and emerging” design features of knowledge building environment and their understanding about the progressive nature of science. It indicated that the epistemic feature of our designed learning environment might have influenced students’ epistemic understanding.

Regarding how knowledge building helped them understand electricity better, some students mentioned about the importance of *taking over agency* in helping them improve their conceptual understanding, as a student reflected in the interview: “*knowledge building helps us understand things better. Because in the forum, we proposed many questions, and we search on Internet to find answers. Actually we were not just searching for answers, we also learned from the internet about why there is such kind of thing, and how it becomes this.....*” This except also showed how knowledge building

might help students expand and deepen their knowledge by let them aware of their own agency in the knowledge construction and knowledge creation process.

6. Discussion and Conclusions

This study designed of a computer-supported knowledge-building environment and examined its role on students' epistemic and conceptual growth. The first research question asked about the effects of the design on students' epistemic and conceptual understanding, quantitative analysis was conducted and it showed that knowledge-building students improved more on epistemic view of science and conceptual understanding compared with the traditional group. To address the second research question, correlation analysis was conducted and results showed that students' epistemic view of science was highly correlated with conception of collaborative discourse, which indicated that the better students understand their own collaborative knowledge building process, the better they may conceive scientists' collective theory building process. Further regression analysis indicated that both knowledge building environment and post epistemology of science predicted students' post conceptual understanding. These quantitative findings were consistent with the previous studies on the effects of knowledge building on epistemic and conceptual understanding (Chan & Lam, 2010), and on the relationship between epistemic cognition and conceptual change (Qian & Alvermann, 1995; Stathopoulou & Vosniadou, 2007), and we further related these constructs to conception of collaborative discourse, and extended the research on epistemic view to the social-cognitive perspective.

The third research question asked the change process of epistemic view and conceptual understanding. Qualitative analysis of students' Knowledge Form discourse showed that the structure of students' discourse shifted from "one question and one response" type of pattern to more sustained and progressive one, which indicated that students' epistemic practice became more sophisticated over time. Meanwhile, qualitative analysis of students' interview showed that students' interpretation of the epistemic design of the knowledge building influenced how they understand the nature of science and learning, which accordingly changed their conceptual understanding about electricity.

This study showed the possibility of changing young students' epistemic view of science with computer-supported knowledge building design. It also showed how students' experience with knowledge building and reflection of this process might have helped them understand the nature of science better. This study contributed to our understanding about way we could embed epistemology components in technology and learning environment design to improve students' epistemic and conceptual understanding. It indicated that if we embed the epistemic feature, such as "deepening", "progressive", and "emerging", in the technology-supported learning environment, students might start to aware of the collective and progressive nature of scientific inquiry through engaging in it and reflecting about it.

This study is only the first iteration of an intervention project. Students' epistemic reflection of their inquiry process was not well scaffolded, future study could be conducted to further improve the design by letting students reflect on the epistemic implication of their experience, and helping them make the connection between their inquiry process and scientists' inquiry process. It was a short intervention, the sample size was small, and the comparison group was not equivalently controlled. The inferences made about the effects of the learning environment should be carefully interpreted; future studies could be designed with longer duration, larger sample size, and better controlled comparison group, to further test the theory. Meanwhile, the mechanism of the knowledge building process could also be further unpacked to provide a richer understanding about the relationship between knowledge building dynamics, epistemic view of science, and conceptual understanding.

References

- Burtis, J. (1998). Analytic Toolkit for Knowledge Forum. Centre for Applied Cognitive Science: The Ontario Institute for Studies in Education/University of Toronto.
- Carey, S., Evans, R., Honda, M., Jay, E., & Unger, C. (1989). An experiment is when you try it and see if it works: a study of grade 7 students' understanding of the construction of scientific knowledge. *International Journal of Science Education*, 11(5), 514-529.

- Carey, S., & Smith, C. (1993). On Understanding the Nature of Scientific Knowledge. *Educational Psychologist*(28), 235–251.
- Chan, C. K. K. (2009). classroom innovation for the chinese learner: Transcending dichotomies and transforming pedagogy. In C. K. K. Chan & N. Rao (Eds.), *Revisiting the Chinese learner : changing contexts, changing education* (pp. 169-210). Hong Kong Comparative Education Research Centre, The University of Hong Kong, .
- Chan, C. K. K., & Lam, I. C. K. (2010). *Conceptual change and epistemic growth through reflective assessment in computer-supported knowledge building*. Paper presented at the International Conference on Learning Sciences
- Chuy, M., Scardamalia, M., Bereiter, C., Prinsen, F., Resendes, M., Messina, R., Hunsburger, W., Teplovs, C., & Chow, A. (2010).. Understanding the nature of science and scientific progress: A theory-building approach. *Canadian Journal of Learning and Technology*, 36(1).
- Conley, A. M., Pintrich, P. R., Vekiri, I., & Harrison, D. (2004). Changes in epistemological beliefs in elementary science students. *Contemporary Educational Psychology*, 29(2), 186-204.
- Hakkarainen, K. (2003). Progressive inquiry in a computer-supported biology class. *Journal of Research in Science Teaching*, 40, 1072-1088.
- Hofer, B. K., & Pintrich, P. R. (1997). The Development of Epistemological Theories: Beliefs About Knowledge and Knowing and Their Relation to Learning. *Review of Educational Research*, 67(1), 88-140.
- Lazakidou, G., & Retalis, S. (2010). Using computer supported collaborative learning strategies for helping students acquire self-regulated problem-solving skills in mathematics. *Computers & Education*, 54(1), 3-13.
- Lederman, N. G., Abd-El-Khalick, F., Bell, R. L., & Schwartz, R. e. S. (2002). Views of nature of science questionnaire: Toward valid and meaningful assessment of learners' conceptions of nature of science. *Journal of Research in Science Teaching*, 39(6), 497-521.
- Lee, E. Y. C., Chan, C. K. K., & van Aalst, J. (2006). Students assessing their own collaborative knowledge building. *International Journal of Computer-Supported Collaborative Learning*, 1, 277-307.
- Liu, L., & Hmelo-Silver, C. E. (2007). *Computer-supported collaborative learning and conceptual change*. Paper presented at the CSCL'07 Proceedings of the 8th international conference on Computer supported collaborative learning
- Perry, W. G. (1970). *Forms of intellectual and ethical development in the college years : a scheme*. New York : Holt: Rinehart & Winston.
- Qian, G., & Alvermann, D. (1995). Role of Epistemological Beliefs and Learned Helplessness in Secondary-School Students Learning Science Concepts from Text. *Journal of Educational Psychology*, 87(2), 282-292.
- Salovaara, H. (2005). An exploration of students' strategy use in inquiry-based computer-supported collaborative learning. *Journal of Computer Assisted Learning*, 21(1), 39-52.
- Scardamalia, M. (2002). Collective cognitive responsibility for the advancement of knowledge In B. Smith (Ed.), *Liberal Education in a Knowledge Society* (pp. 67-98). Chicago: Open Court.
- Scardamalia, M. (2004). CSILE/Knowledge forum *Education and technology: An encyclopedia* (pp. 183-192). Santa Barbara: ABC-CLIO.
- Scardamalia, M., & Bereiter, C. (2006). Knowledge building: Theory, pedagogy, and technology. In K. Sawyer (Ed.), *Cambridge Handbook of the Learning Sciences* (pp. 97-118). New York: Cambridge University Press.
- Schommer, M. (1990). Effects of beliefs about the nature of knowledge on comprehension. *Journal of Educational Psychology*, 82(3), 498-504.
- Smith, C. L., Maclin, D., Houghton, C., & Hennessey, M. G. (2000). Sixth-Grade Students' Epistemologies of Science: The Impact of School Science Experiences on Epistemological Development. *Cognition and Instruction*, 18(3), 349-422.
- Stathopoulou, C., & Vosniadou, S. (2007). Exploring the relationship between physics-related epistemological beliefs and physics understanding. *Contemporary Educational Psychology*, 32(3), 255-281.
- Tao, P. K., & Gunstone, R. F. (1999). Conceptual change in science through collaborative learning at the computer. *International Journal of Science Education*, 21(1), 39-57.
- Vosniadou, S., & Kollias, V. (2003). Using collaborative, computer supported, model building to promote conceptual change in science. In E. D. Corte, L. Verschaffel, N. Entwistle & J. v. Merriënboer (Eds.), *Powerful Learning Environments: Unraveling Basic Components and Dimensions* (pp. 181-196): Pergamon.
- Zhang, J., Scardamalia, M., Lamon, M., Messina, R., & Reeve, R. (2007). Socio-cognitive dynamics of knowledge building in the work of 9- and 10-year-olds. *Educational Technology Research and Development*, 55(2), 117-145.

Zhang, J. W., Scardamalia, M., Reeve, R., & Messina, R. (2009). Designs for Collective Cognitive Responsibility in Knowledge-Building Communities. *Journal of the Learning Sciences, 18*(1), 7-44.

Math Creation: Integrating Peer Tutoring for Facilitating the Mathematical Expression and Explanation

Euphony, F. Y. YANG^{a*}, Hercy, N. H. CHENG^b & Tak-Wai CHAN^a

^a*Graduate Institute of Network Learning Technology, National Central University, Taiwan*

^b*Collaborative & Innovative Center for Educational Technology, Central China Normal University, China*

*euphony@cl.ncu.edu.tw

Abstract: The purpose of this study is to contribute insights into how math creation integrated peer tutoring can facilitate students' mathematical expression and explanation. Twenty-five second-grade primary students play the role of teachers to construct their math creations as the teaching materials to teach their partners. Specifically, the students need to solve given word problems and produce three forms of creation—including drawing expression, arithmetic expression, and solution explanation—to justify their solutions. This study shows that peer tutoring can promote students' drawing expression and solution explanation by providing opportunities for students to reexamine their math creation mutually. However, the progress of arithmetic expression does not achieve significantly. Besides, this study also finds that high and low achievers have different sequences in completing math creations and ways of participation. Finally, how computers facilitate and change students' mathematical expression and explanation compared with paper-based environment is also discussed.

Keywords: Math creation, peer tutoring, mathematical explanation, mathematical expression

1. Introduction

During the last decade, the educational reform movement in Taiwan has advocated for increasingly emphasizing students' mathematical expression and explanation. One of the government policies in Ministry of Education of Taiwan (2003) is "to understand the comprehension of the mathematical language, such as symbols, terms, tables, graphs and informal deductions". Furthermore, mathematical expression and explanation, a critical approach to present the mathematical language, may show how people understand mathematical concepts and use those ideas. More specifically, peer explanation may facilitate spontaneous using the mathematical language such as diagrams in solving mathematics word problems (Uesaka & Manalo, 2011).

Teaching mathematical concepts and principles by depicting problems graphically and using peer explanation activities during mathematics instruction had found to be consistently effective (Griffin & Jitendra, 2009). During peer explanation, students' gains in drawing diagrams likely contributed to their diagram construction skills (Uesaka & Manalo, 2011). Besides, the explanation of students as explainers may become more complete because they have to monitor their own misunderstanding and knowledge gaps (King, 1994), which may help them understand (Roy & Chi, 2005). In other words, mathematical explanation may facilitate mathematical comprehension (McNamara, 2004). On the other hand, learning in pairs or small groups has positive learning benefits on children's learning development (Dillenbourg, 1999). Therefore, applying peer explanation to peer tutoring could be an adequate learning approach to foster students' mathematical expression and explanation because tutors' explanations may expose tutees to the information they lacks (VanLehn et al., 2007), which may assist their tutees' learning (Chi, Siler, Jeong, Yamauchi, & Hausmann, 2001).

Nowadays, as most classrooms have provided Internet access and one-computer-per-student, it is possible for students to create their own math creations as an educational strategy for training mathematical expression and explanation. Chi (2009) posits that learners benefit most from active constructing their own artifacts and explanations. Furthermore, peer tutoring is used as a good strategy

for the facilitation of mathematical explanations (Berghmans, Neckebroeck, Dochy & Struyven, 2013). Developing mathematical representation and solution explanation by constructing an appropriate math creation for integrating peer tutoring activity is likely to improve the comprehension and completion of the math creation. Students are also more likely to apply these skills through peer tutoring, thus advancing the quality of their works. Taking the literature and current trends together, a question arises if constructing math creation could enhance students' mathematical expression and explanation in a peer tutoring activity. Therefore, the current study is conducted to examine the effects of math creation followed by peer tutoring to improve the performance of second graders in their mathematical expression and explanation. The method for exploring this question is described as follows.

2. Method

This research investigated how students constructed their math creations by integrating peer tutoring for facilitating mathematical expression and explanation. Students had to write down their solutions (arithmetic expression), draw the mathematical representation (drawing expression), as well as explain how and why they solve word problem in their own ways (solution explanation). This section will describe the participants, the activity procedure, the learning system and the supplementary learning sheet, followed by data collection and analysis.

2.1 Participants

Twenty-five second-grade primary students (13 boys and 12 girls) and their teacher from the same class at a public school in the north region of Taiwan participated in this study. The students had their own tablet PCs brought by their parents in schools since first grade and had developed good competence and familiarity in mathematical self-learning. In this study, they were assigned to six groups by their teacher. There were four or five students in each group, where everyone was further paired to each other. The teacher was willing to participate in the activity of math creation, so she encouraged students to engage in peer tutoring and math creation. Besides, she also provided students with many opportunities to show their works and to teach the whole class in front of the classroom.

2.2 The Learning System & Supplementary Learning Materials

The system of math creation was called Little Mathematical Teacher (LMT), which was designed to assist students' learning and to visualize their math creations with a sketch-board and a sharing zone. Besides, the researchers also provided the supplementary learning sheets to scaffold students during the math creation and peer tutoring.

For the purpose of assessing students' mathematical expression and explanations in math creation, students were asked to complete a word problem solving assignment in the sketch-board. The sketch-board was divided into three parts, including drawing expression, arithmetic expression, and solution explanation (see Figure 1). The sketch-board provided a component library, which contained various mathematical components, such as coins, building blocks, and carton images etc., suggested by the teacher in order to meet the needs of primary students. Students can utilize those components to prepare their drawing expression, arithmetic expression and solution explanation for concretely explaining their solution procedures in their math creations.

Meanwhile, different word scaffoldings were used according to students' abilities of mathematical explanation. In initial activities, more word descriptions were provided to help students think related mathematics concepts by completing the keywords of the word problems. Students can learn how to explain their mathematical ideas to others through imitating the similar explanatory patterns. After that, the system only provided simple conjunctions to facilitate students to think appropriate solutions, the ways of solving, and what the most important reason was. For example: *[First, I used] one calculating method, [because] (I) wanted to [Then, I used] one calculating method, [because] ...*”.

Besides, the LMT provided a sharing zone to display all students' math creations. When students finished their math creations and saved them, the creations were uploaded to the sharing zone. Students only had to choose the classmate's number and then his/her creation would show up (see

Figure 2). This function helped students share, observe, and understand the math creations of the whole class. They can thus learn mutually and take advantage of this function to teach their partner about what the mathematical concepts applied and how to solve the problem.

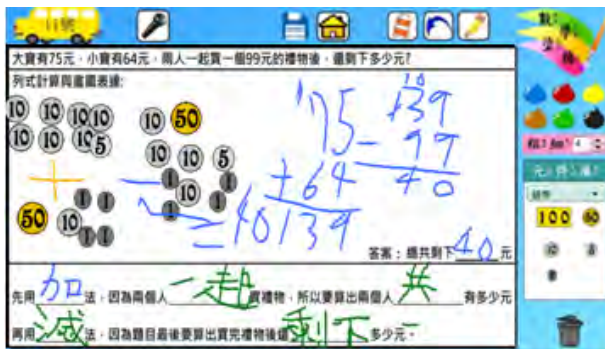

Figure 1. The interface of the sketch-board



Figure 2. Individual's math creation displaying in the sharing zone

To facilitate students' math creations, three supplementary learning sheets were given. Two question sheets embedded in the system were used in different stages. One question sheet listed relevant questions about the assigned word problems. This study adopted two forms of a question sheet revised from Mason (2000) to prompt students' awareness development of mathematical thinking and to allow students to answer questions for themselves or a partner. The two forms were enquiring and testing questions. First, enquiring questions guided learners to understand every meaning through several divided problem solving steps. Hence, this study adopts enquiring questions to guide students explaining the meaning of problems by drawing and arithmetic expression when students created mathematical artifacts. Students can also ask their partner or classmates some questions as those on question sheet. Thus, even if they have not thought of any questions on their own, they can still take advantage of the question sheet to join the peer tutoring activity. The example questions were shown as follows. (1) What does this problem ask for? (2) How do you express six boxes of milk and each box have twelve bottles of milk by drawing expression? (3) How do you express the milk drank by drawing expression? (4) How do you express the milk left by drawing expression? (5) What does each calculation mean?

Second, testing questions were used to ask students to explain their own mathematical thinking in order to evaluate their understanding, and help peer mutually examine the correctness of their drawing expression, arithmetic expression, and word explanation. Additionally, students can ask relevant questions if they have any unclear or doubtful part, for example:

- (1) If there is something unclear or incorrect in the instructor's drawing expression, please question him/her.
- (2) Is his/her arithmetic expression correct? If there is something wrong, please find out and tell him/her the correct arithmetic expressions.
- (3) Is his/her explanation correct? If there is something wrong, please find out and tell him/her how to modify it.

Many students spent most of their creating time in thinking about how to draw the mathematical representation to express their solutions. Therefore, the researchers provided an additional supplementary learning sheet with six examples of mathematical representation in paper form to assist students' drawing expressions.

2.3 Learning Procedure

This study was conducted for 13 weeks. All students participated in 13 times of learning activities, and each learning activity took two class periods, approximately 80 minutes. Before the experiment, the researchers explained the usage of the sketch-board to the students and asked them to construct their own math creations for teaching their students (*i.e.* paired members). These creating steps were chosen and proceed in the sequence based on Polya's (1957) four stages of problem solving: understanding the problem, devising a plan, carrying out the plan, and looking back. However, the final step, *i.e.* checking

calculations, was revised to solution explanation to help students re-think how they solved the problem. Furthermore, in order to promote the activity of math creation smoothly, the first step, *i.e.* understanding the problem, was conducted as an independent session by discussing solutions with their partners to understand the condition given and the problem asked. Therefore, four learning sessions were described as follows.

Session 1: Understanding the word problem. In the first session, each student received a word problem and a question sheet (the details were in the Supplementary Learning Sheet). Students read the word problem and, as a group, tried to understand it by discussing what the problem meant and how to explain its solution with their partners. They, furthermore, tried to connect with the requirement of solving such problem and think about what was the proper strategy of the problem. Students thus got joint understanding of problem required. This session usually took five minutes.

The students worked in pairs. In the first to seventh activities, students were provided the same word problem in order to help them familiar with the activity and discussed with each other more easily. In addition, they were able to learn how their peers solved the same problem with different strategies and explanations. After that, students were given parallel word problems in the same pair to enhance their learning and thinking more other word problems with similar concept and structure, but had different scenarios and numbers for avoiding students feeling bored with the same word problems, which may lead to reduce the benefits of peer tutoring. The examples of parallel word problems were shown as follows.

(1) Liz invited 26 classmates to her home for eating cakes. Every cake was divided into 13 pieces. Liz prepared 4 cakes, and everyone could have one piece. How many pieces of cakes left at last?

(2) Mei prepared 7 cakes, and each cake was divided into 10 pieces. She invited 26 classmates to her home for eating the cakes. Everyone had 2 pieces. How many pieces of cakes left at last?

Session 2: Prepare one's math creation. All students prepared their math creations as the teaching materials individually in the classroom. More specifically, s/he solved a problem on his/her own and preparing his/her math creation on the sketch-board, including: (1) Drawing expression: Students used words, symbols, models and manipulative materials as their mathematical representations to devise a plan and convey their ideas and communicative information; (2) Arithmetic expression: Students wrote down their mathematical equations for solving this problem as carrying out the plan; (3) Solution explanation: Students reflected how and why they solved the problem and wrote their solution explanation for looking back. Students had to try an understandable approach in his/her drawings and explanation for others because one's drawing created the mental representations of the solution. After finishing the math creation, the student could save it and then view other math creations made by their classmates in the online sharing zone.

Session 3: Peer tutoring. Students were given ten minutes for tutoring the partner in each group. The researcher asked students to use a recorder as a microphone. For sharing ideas with a peer, students may hold the recorders to play the role of little math teacher and debrief the representation of his/her thinking, such as how s/he solved the problem and what s/he considered. And then the partner had to take over the recorder and play the role of learner to ask the little math teacher some relevant questions. The little math teacher had to answer these questions. At the time, the learner was easy to check with the solution of the little math teacher, because s/he might discover some incorrect parts of the solution during debriefing. In another turn, the paired students had to switch their roles.

Session 4: Presenting solution. Students had to teach the whole classmates by presenting their drawing and solutions of math creation in the electronic whiteboard in the final session. However, due to the time limit, the teacher only chose seven or eight students as the presenters in each activity. Then the other students may ask the presenter some questions about their solutions. After the solution presentation, s/he may reflect on his/her math creation and oral explanation for improving next time.

2.4 Data collection and analysis

To examine how students advanced the mathematical expression and explanation in LMT, data collection included students' math creations, class observations, and interview. The researchers calculated the scores of three sub-abilities in students' math creation, which included: drawing expression, arithmetic expression, and solution explanation. Each sub-abilities was 5 points at most, so the total score is 15 points. We scored the expression and explanation by considering if the key concept was involved in the description and if the relationship of conditions problem given were showed. The

evaluation criteria of drawing expression were shown as follows. (a) 1=incorrect representation, which using concrete objects referred to the problem, but the representation was incomprehensible; (b) 2=correct but drawing objects without marking meanings; (c) 3=calculation form of calculating representation; (d) 4=correct but incomplete schematic representation; (e) 5=schematic visual representation, which could express the spatial relations between objects in a problem for explaining their solution strategy. To ensure the reliability of scores of math creation, the scores was evaluated by two raters simultaneously. The inter-rater reliability of was $0.91 \cdot p < .000$. Besides, that classroom note focused on the nature and type of tutoring undertaken by primary students. In addition, the semi-structured interviews were conducted to interview the class teacher and the high, moderate, and low achieving students according to their performance of math creations. These qualitative data was transcribed, coded, categorized, and compared in multiple ways for emerging meaningful themes. The classroom notes were used throughout the data analysis process for the purposes of triangulation.

3. Result

3.1 The progress of the expression and explanation in the math creations

The aim of this study was to investigate the mathematical expression and explanation advancement. We examined and marked the online math creation of whole class to gain better understanding of the students' learning process. Figure 3 provided the information about how the means of students' expression and explanation in their math creations changed in 13 times. Overall, it was clear that their mathematical expression and explanation had upward trends.

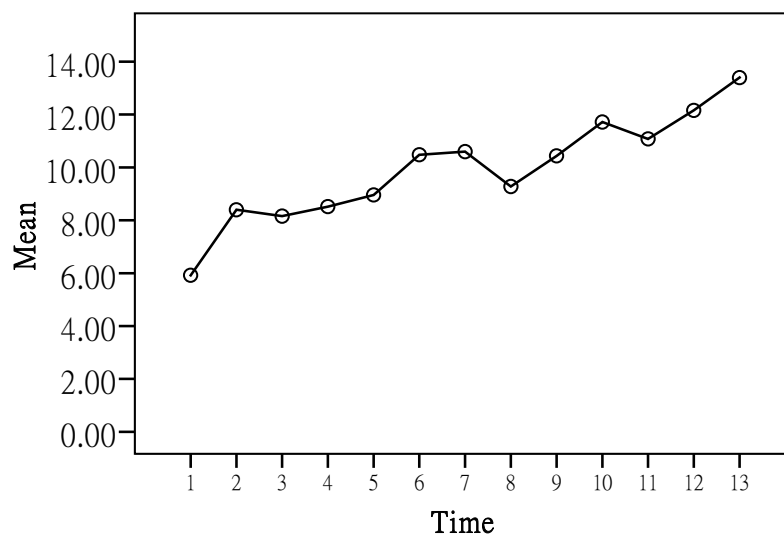

Figure 3. The means of students' expression and explanations of math creations in each time.

Moreover, Figure 4 showed the information about how the means altered by the three sub-abilities in their math creations among 13 times. The score of arithmetic expression was only 2.68 points at the first time. Because some students thought drawing expression was equal to the arithmetic expression and thus did not write the part. However, the mean was a rapid climb to 4.64 points as students caught the key in the second time. After the third time, the following means were a steady increase scores from 4.56 to 5 points. As for the scores of drawing expression, it started at 2 points at first time and after a slight fluctuation reached to just less than 5 points in thirteenth.

It was notable that the scores of both drawing expression and solution explanation had similar patterns. In contrast with the relatively stable performance in the arithmetic expression, the scores of both drawing expression and solution explanation were matched from first to fourth time with 2 points, after a slight increased at sixth time, then dropped to 2.4 points at the eighth time because students had to deal with an advanced learning topic. More specifically, the topic shifted from addition and subtraction mixed problems to addition, subtraction, and multiplication mixed problems. Students had to use new explanatory approach. Meanwhile, students were given parallel word problems from eighth

time. But their scores later sustained increased and reached to the highest score at thirteenth time. To identify the relationship between drawing expression and solution explanation, Pearson correlation coefficient was applied. There was a positive correlation between the two variables, $r = 0.894$, $p = 0.000$, which mean that drawing expression and solution explanation had a high, positive correlation. Increases in overall performance of the drawing expression were correlated with increases in performance of the solution explanation.

Overall, students' scores in drawing expression and solution explanation were lower than arithmetic expression from beginning to the end, which meant that the two sub-abilities needed further enhancement. However, through the activity, students gradually improved their drawing expression and solution explanation, which were closed to the level of arithmetic expression in the end.

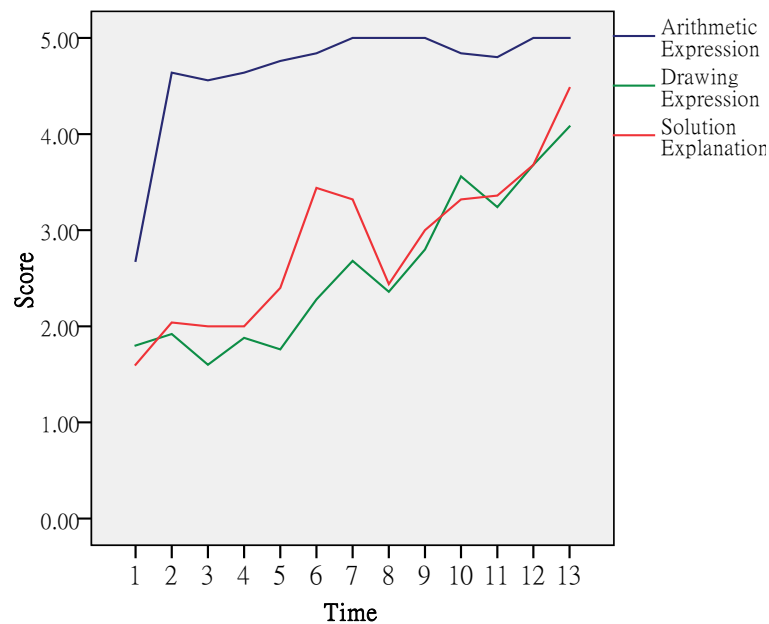

Figure 4. Means of each dimension in students' math creation.

Nevertheless, this study did not have the control group and thus needed more evidence to confirm the improvement of math creation. The researchers compared the initial and final score of math creation to understand the degree of advancement. As mentioned earlier, students were unfamiliar the system operation and rules of math creation at first. However, once students were proficient with system and peer tutoring procedures, they can devote their full attention to the actual content of the lessons (Mathes, Howard, Allen, & Fuchs, 1998). So this study used paired samples t-test to compare the means of second and thirteenth math creation. The students achieved mean scores in second math creation (Mean = 8.40, SD = 2.52) and thirteenth math creation (Mean = 13.40, SD = 3.06) (see Table 1). The result showed a significant difference between the total scores of the two math creations ($t(24) = -10.74$, $SE = .47$, $p = .00$).

Table 1: Students' performances on the second and thirteenth math creation.

Math creation	Second artifacts		Thirteenth artifacts	
	Mean	SD	Mean	SD
Arithmetic expression	4.64	1.15	5.00	0.00
Drawing expression	1.92	1.91	4.08	1.29
Solution explanation	2.04	0.61	4.48	1.08
Total	8.40	2.52	13.40	3.06

Furthermore, in order to investigate the effect of these sub-abilities in the math creation individually, further analysis was conducted. The results showed that integrating peer tutoring for facilitating mathematical expression and explanation resulted in significant improvement on the drawing expression ($t(24) = -2.28$, $SE = .2$, $p = .00$), on the solution explanation ($t(24) = -14.03$, $SE = .17$, $p = .00$). However, there was no significant difference in the arithmetic expression ($t(24) = -1.57$,

$SE=.23, p=.13$). The findings suggested that these sub-abilities of drawing expression and solution explanation in math creation could be fostered at the same time when they were trained through integrating peer tutoring, while most of their arithmetic expression were very close to the full score therefore it did not show significant improvement.

Apart from the statistic data from the scores of students' math creation, the researchers also interviewed the class teacher to get her perception about students' improvement. The teacher responded "some students, such as S5, when he found out an appropriate drawing expression like number line; he would adopt this method afterwards and solve problems accurately. Besides, as student introduced his/her math creation, I could find their confidence never showed before." As long as students found out their ways to overcome their difficulties of mathematical expression and explanation, they could perform well in the later math creations and have more confident in peer tutoring. They were also more willing to raise their hand for presenting to the whole class. After doing so, they got more feedback from other classmates and teacher, and thus modify their math creations to make a positive loop.

3.2 Progressive examples of the math creations

The progress of math creation was observed by different achieving students. A high achieving student S15 said: "I didn't know how to explain or teach others about how to solve the problem at first, but now I learned how to explain why I use the addition, multiplication, and subtraction." The case of S15 reflected that students had got the point on how to explain the solving method for helping others understand in his solution explanation of math creation through peer tutoring. In addition, S5, a moderate achieving student mentioned that "I could learn another method [for problem solving] and solve the mathematical problem better" implying that peer tutoring allowed students to talk over mutual solutions, and students were able to view other classmates' math creations in the sharing zone. Through sharing knowledge and assimilate each other's ideas, students learned new problem-solving strategies and used those for refining their expression and explanation of the math creation. Similarly, another low achieving student S2 stated "My classmates and I checked the answer mutually to make sure that our equations and answers were correct." Students' behavior suggested that integrating peer tutoring into math creation facilitated students not only to provide helps but also to receive aid from their partners.

Additionally, this study provided a typical example among students to show the progress of students' math creations. In the early period, most children's drawing expression only adopted coins to reflect their calculation process. Figure 5 was a typical example. It showed that student did not understand how to map the details of the problem onto his drawing expression. The word problem was "Da-bao had 75 dollars, and Xiao-bao had 64 dollars, they bought the gift with 99 dollars together, how much money did they leave?" S5 used many coins as representations in his drawing to replace the number in calculation. Besides, he used apples as the left money, and each apple represent 10 dollars. More specifically, he only put all coins together. All the numbers in the problem were showed in the drawing, but the relationship between the money was not clear, such as which is addend, which is minuend, or subtrahend. In addition, the student misused two different things, coins and apples as the same representations: money. Although the student could calculate by using the information the problem provided as his arithmetic expression, and also fill correct key words in the blanks as the solution explanation, the representation implied that he did not really understand how to draw the mathematical meaning of addition and subtraction mixed problem or could not convey it. The drawing was not correct for other students to understand his thinking and the concept of problem solving.

In the end of the study, the students began to think different explanatory methods and examine the process and reason one step after another. Figure 6 illustrates the students' mathematical expression and explanation in the final math creation. In this example, the word problem was that "A packet of biscuits costed 15 dollars, Miu bought 5 packets, she paid 100 dollars, how much change should she get?" S5 drew the box represented the money of a packet and marked 15 in each box, so there were five boxes, and he wrote the total boxes meant 75 dollars. This drawing corresponds with the representation of the problem identified in the first step. Next he drew two row blocks. There were ten blocks in the upper row and seven blocks with half size of block in the lower row. It's obvious that S5 combined the information of the same unit onto the relevant diagram and flagged the goal needed to be found in the problem by using a question mark. More specifically, he drew ten blocks of ten as the paid money, one hundred dollars, then seven blocks and half size of block of ten as the total money needed to pay, and

finally used a question mark to represent the unknown money given back. The student's understanding was demonstrated by how he mapped the details of the problem onto his drawing expression.

Furthermore, S5 knew the reason why he used the multiplication and subtraction and the representing meaning of each number. He explained that "[First, I used] multiplication, [because] one packet cost 15 dollars, and Miu bought 5 packets (calculated the price of five packets). [Then, I used] subtraction, [because] Miu should paid 75 dollars, but she paid 100 dollars (and the change was the price)." It was clear that the student properly used the representation and explained his solutions.



Figure 5. The initial math creation.

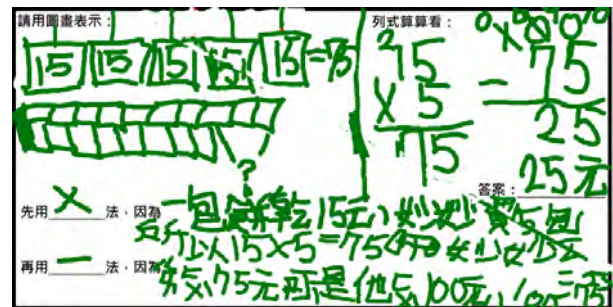

Figure 6. The final math creation.

The difference of two math creations showed the improvement of mathematical explanation from the beginning to the end. It was obvious that constructing students' own math creation and peer tutoring may facilitate students' mathematical explanatory strategies, enhance spontaneously constructing more appropriate diagrams, absorb the mathematical expressing methods of their classmates, and then contribute to his own mathematical expression and explanation.

3.3 The sequences in completing math creation and ways of participation

The teacher and most students had positive attitudes toward constructing their own math creations and engaging in using their works to the peer tutoring activity. However, the classroom observation and interview showed that some students encountered obstacles and tried different ways to involve themselves in the learning activity. The researchers interviewed two low achievement students S13 and S14 and two high achievement students S1 and S15 to further inquiry their perceptions and habits for math creations. Both low achieving students preferred to finish the arithmetic expressions first. S13 emphasized that "Drawing is a little bit difficult, so I write the arithmetic first. I can calculate the answer". It reflected that S13 might not able to draw his solution, but at least he could finish the arithmetic expression in his math creation whether the answer was right or not. Similarly, S14 usually tried many different drawing expressions and then erased them repeatedly, but left the arithmetic expression without drawing expression and solution explanation in the end. Many low achievers had the same behaviors with S14. Such phenomenon was changed gradually after the learning sheet of drawing examples was provided for them to rely on and imitate. Students started to try drawing expressions and saved them.

The teacher usually guided low achievers by monitoring their progress of math creation from the sharing-zone and reminding them to utilize clear marks and descriptions on their drawings expression and solution explanations. Some of them might thus modify the two parts; nevertheless, due to the abilities and time limitation, students might not always complete their drawing expression and solution explanations among the remaining time. However, they would still try to explain their solutions in the peer tutoring but focus on explaining how to calculate the mathematical equations instead of why they solved word problems in that way.

Contrary to the low achieving students, the high achieving students had different creating procedures. S15 preferred drawing first; she said "I think drawing expression is harder. I can't merely draw the arithmetic; I have to consider how to correspond to the problem and my solution. It would take more time to finish, so I usually draw first, and the following arithmetic expression and solution explanation will be finished very soon." In addition, S1 chose the alternation of drawing and arithmetic in his math creation. S1 thought "drawing helps me think about how to solve the problem. I write my arithmetic expression after drawing, and then repeat the procedure [to my solution]". Hence we knew

that high achieving students preferred to draw the mathematical representation first although they also felt that drawing expressions were more difficult. Besides, it seemed that the high achiever tended to use the drawing expression as an assistant approach for arithmetic expression rather than distinguished the two expressions as unrelated elements.

Overall, students spent more time on drawing expression and solution explanation rather than arithmetic expression. Most students tended to finish the arithmetic expression and then back to think about how to draw the mathematical representation and solution explanation except for the high achievers. Low achievers usually only completed the arithmetic expression without examples to rely on. Students had learning tension on withdrawing their drawing expression and solution explanation or not because they could not confirm the correctness of the two parts. Besides, compared with writing the solution explanation, students preferred to explain how to solve problems by oral presentation because their oral explanation was always provided more and sooner than the written explanation.

4. Discussion

This study intends to facilitate students' mathematical expression and explanation by integrating peer tutoring into math creation. Traditional mathematics education emphasizes on the correctness of repeated calculation, so that students may perform well in the arithmetic expression. However, the same procedure (e.g., subtraction) used to solve all problems within a chapter (Bonotto, 2013), students may not have the opportunity to distinguish among problems which need different solutions. This study tries to help students understand the meaning and structure of a problem and asks them to address their mathematical knowledge and solving processes by math creations. Students may fail to develop their mathematical expression and explanation at first, once they gain access to math creation to internalize mathematical concepts or relationships, their improvements, whether in drawing expression, arithmetic expression or solution explanation, were seen clearly.

Computers provide an easier and even instant access with a wider audience for students' math creations compared to similar activities with prepared papers. The sharing zone in the LMT supports not only students' mathematical written expression and explanation, but also oral explanation and feedback during the peer tutoring. The sharing zone demonstrates students' math creation and helps students reflect why they construct the expression and explanation in the ways. Besides, teachers can monitor students' progress, analyze students' problems, and examine the knowledge status of students. Subsequently, both teachers and peers can provide real-time feedback and recommend revisions. Students who share their math creations are able to take advantage of the availability of classmates' works to communicate with each other to get more perspectives and suggestions. Therefore they can draw on the strong points to offset the weaknesses for modifying and refining their math creations, and further expand their capacity to interpret their mathematical concepts.

In contrast, the second-grade students loved to draw creative expression. Many students drew a great deal of irrelevant details in their mathematical representations. Through sharing math creation, students may know more than one way to express their mathematical representations. However, after students chose more efficient and effective representations by observing classmates' artifacts in the sharing zone, they may thus become less creative. Their mathematical representation specifically changed from concrete materials mixed with default components to more abstract self-drawing pictures. Although this was a normal development and also an important goal for primary mathematics, this study still reflected that developing the ability of problem solving and creativity simultaneously from initial to the end was not easy in practical classrooms.

5. Conclusion and Future Work

The aim of this study was to improve students' mathematical expression and explanation by integrating peer tutoring into math creation. We analyzed students' math creation of the whole learning activity and compared the performance of second and final artifacts to identify students' advancement. The drawing expression and solution explanation achieved significant difference, except the arithmetic expression. In addition, this study carried out the interview and collected student's math creation in different activity sessions as learning evidences in terms of mathematical expressions and explanation. The low and high achievers' creating sequence in math creation were also explored. However, some questions still needed to be explored. For example, spending two classes to solve one word problem may be

considered time-consuming for many teachers. Therefore, how to spend less time on completing such learning activities is still a question. Besides, how students' mathematical representation advanced and how they mapped the details of the problem onto his drawing expression in different stages during the thirteen activities deserved further inquiry, which will need future studies.

Acknowledgements

The authors would like to thank the National Science Council of the Republic of China, Taiwan, for financial support (NSC-101-2631-S-011-002 、 NSC-101-2511-S-008-016-MY3 、 NSC-101-2811-S-008-009 、 NSC-101-2811-S-008-010 、 MOST103-2511-S-008-009-MY3), and Research Center for Science and Technology for Learning, National Central University, Taiwan.

References

- Berghmans, I., Neckebroek, F., Dochy, F., & Struyven, K. (2013). A typology of approaches to peer tutoring. Unraveling peer tutors' behavioural strategies. *European journal of psychology of education*, 28 (3), 703-723.
- Bonotto, C. (2013). Artifacts as sources for problem-posing activities. *Educational Studies in Mathematics*, 83(1), 37-56.
- Chi, M. (2009). Active-Constructive-Interactive: A Conceptual Framework for Differentiating Learning Activities. *Topics in Cognitive Science*, 1, 73-105.
- Dillenbourg, P. (1999). What do you mean by collaborative learning? In P. Dillenbourg, *Collaborative-learning: Cognitive and Computational Approaches* (pp. 1-19). Oxford: Elsevier.
- Griffin, C., & Jitendra, A. (2009). Word Problem-Solving Instruction in Inclusive Third-Grade Mathematics Classrooms. *The Journal of Educational Research*, 102(3), 187-201.
- King, A. (1994). Guiding knowledge construction in the classroom: Effects of teaching children how to question and how to explain. *American Educational Research Journal*, 31(2), 338-368.
- Lin, Y. H., & Lee, Q. Y. (2004). A study of ability on mathematical communication for pupils of elementary schools. *Journal of Educational Measurement and Statistics*, 12, 233-268.
- Mathes, P. G., Howard, J. K., Allen, S. H., & Fuchs, D. (1998). Peer-Assisted Learning Strategies for First-Grade Readers: Responding to the Needs of Diverse Learners. *Reading Research Quarterly*, 33(1), 62-94.
- McNamara, D. (2004). SERT: Self-explanation reading training. *Discourse Processes*, 38, pp. 1-30.
- Polya, G. (1957). *How to Solve It?* Princeton: Princeton University Press.
- Roy, M., & Chi, M. (2005). The self-explanation principle in multimedia learning. In R. Mayer, *The Cambridge handbook of multimedia learning* (pp. 271-286). Cambridge: Cambridge University.
- Uesaka, Y., & Manalo, E. (2011). The effects of peer communication with Diagrams on students' math word problem solving processes and outcomes. *Proceedings of the 33rd Annual Conference of the Cognitive Science Society* (pp. 312-317). Austin, TX: Cognitive Science Society.
- VanLehn, K., Graesser, A. C., Jackson, G. T., Jordan, P., Olney, A., & Rose, C. P. (2007). When are tutorial dialogues more effective than reading? *Cognitive Science*, 31, 3-62.

Providing Knowledge-Related Partner Information in Collaborative Multimedia Learning: Isolating the Core of Cognitive Group Awareness Tools

Daniel BODEMER* & Alexander SCHOLVIEN

Media-Based Knowledge Construction, University of Duisburg-Essen, Germany

*bodemer@uni-due.de

Abstract: Cognitive group awareness tools support learners in dealing with specific challenges of computer-supported collaborative learning scenarios. This paper suggests three supporting functions underlying cognitive group awareness tools and proposes to disentangle them in three consecutive experimental studies with regard to multimedia learning. It focuses on one of those studies that systematically investigates whether providing knowledge-related partner information can improve collaborative learning with multiple external representations and with dynamic and interactive visualizations. Learning dyads ($N = 120$) were compared in four groups that differed with regard to the presentation of knowledge-related partner information during two subsequent collaboration phases: (1) learning with multiple static representations and (2) learning with dynamic and interactive visualizations. Results indicate that providing partner information during collaboration can facilitate meaningful learning discourses and improve learning outcomes.

Keywords: computer-supported collaborative learning, cognitive group awareness, multiple external representations, interactive visualizations

1. Introduction

Collaborative multimedia learning is a promising but challenging scenario. Learning partners have to overcome individual as well as specific collaborative barriers simultaneously (Bodemer, Kapur, Molinari, Rummel, & Weinberger, 2011; Bromme, Hesse, & Spada, 2005; Dillenbourg & Bétrancourt, 2006). With regard to individual multimedia learning, research addressed various difficulties of learning with multiple external representations (MER; e.g., Ainsworth, 2006) or dynamic and interactive visualizations (DIV; e.g., de Jong & van Joolingen, 1998). Moreover, when learning collaboratively, learners have to additionally (1) establish references between external content and communication, (2) construct a common ground based on mental representations of their learning partners' knowledge, and (3) coordinate communication and interaction processes in a goal-oriented way (cf. Bodemer, 2011; Clark & Brennan, 1991).

This paper focuses on cognitive group awareness (CGA) tools that support learners in dealing with the specific challenges of computer-supported collaborative learning (CSCL). It has been shown that they can improve collaboration processes and learning outcomes while enabling self-regulated learning processes (cf. Bodemer & Dehler, 2011; Janssen & Bodemer, 2013; Ogata & Yano, 1998). Moreover, CGA tools are suited to be combined with instructional tasks well-proven in multimedia learning research. It was already shown that they can significantly support collaborative learning with both MER (e.g., Bodemer, 2011) and DIV (Scholvien & Bodemer, 2013).

As a core feature, cognitive group awareness tools provide knowledge-related information on learning partners (e.g., a learning partner's hypotheses, test scores, interests or opinions), which can facilitate grounding and partner modeling processes during collaborative learning. Group awareness tools usually provide further support in two ways. On the one hand, knowledge-related information on learning partners do not only comprise information on a person but also refer to specific and often preselected content (e.g. a learning partner's hypothesis regarding a single element of the learning

material), thereby cueing essential information of the learning material and constraining content-related communication. On the other hand, group awareness tools frequently provide information in a way that allows for comparing learning partners (e.g. adjacently presenting hypotheses of two learning partners), thereby guiding learners to discuss particularly beneficial issues (e.g. conflicting hypotheses as nudges for collaboratively elaborating divergent perspectives).

While all three tool features can potentially support learners in overcoming CSCL challenges, they are usually applied and investigated in combination. Thus, it is an open research question if the positive learning effects of providing group awareness information are based on only one, on two, or on all three features. In order to disentangle the effects of the underlying supporting functions in CGA tools, we propose three consecutive experimental studies that systematically vary only one of the tool features in each study (see Table 1).

Table 1: CSCL challenges and CGA tool support in collaborative multimedia learning.

CSCL Challenge	Tool Feature	Support/Function	Study
connecting communication and learning material	information cueing	constraining content-related communication	1
establishing a common ground	providing partner information	partner modeling	2
structuring the learning discourse	visualizing knowledge constellations	socio-cognitive guidance	3

Study 1 already showed that cueing relevant information in MER- and DIV-based learning material focuses learners' attention and communication to essential aspects and improves learning outcomes (Scholvien & Bodemer, 2013). This paper reports results of the second study that investigates the core feature of CGA tools (i.e., providing knowledge-related partner information). It is investigated if this feature is effective in addition to the beneficial effect of information cueing. It is hypothesized that providing partner information facilitates partner modeling, guides learning processes, and enhances learning outcomes during MER-based and DIV-based collaboration.

2. Method

2.1 Design and Procedure

In this experimental study, learning dyads were individually provided with interdependent learning material comprising either visual or algebraic information about the analysis of variance (ANOVA). Afterwards, learning partners collaborated in two subsequent phases in which they were instructed to collaboratively elaborate on statistics concepts and interrelations by means of different multimedia learning material:

During the first collaboration phase, learners are provided with static multiple external representations (MER), i.e. visualization (VANOVA; Oestermeier & Barquero, 2001) and formula components regarding the one-way analysis of variance such as observed values, experimental groups, means, sums of squares, mean squares, and *F* ratio.

During the second collaboration phase, this visualization was augmented by several dynamic and interactive components (DIV) that enabled participants to modify visual components (e.g., number of observed values and of experimental groups; size of observed values and group means) and to monitor the resulting effects on other components (e.g., sums of squares, mean squares, and *F* ratio).

Additionally, in each collaboration phase, partner information was provided in two of the four experimental groups, thus leading to four different experimental groups (MER0_DIV0 vs. MER1_DIV0 vs. MER0_DIV1 vs. MER1_DIV1; cf. Figure 1). Both collaboration phases were operated using a Samsung SUR40 multi-touch tabletop with Microsoft PixelSense that enabled face-to-face communication between learning partners as well as the synchronous manipulation of the ANOVA animation.

Prior to each collaboration phase, learners indicated their individual knowledge, i.e. assumptions on different elements and relationships within the ANOVA. Individual knowledge tests were conducted before (KT 1) and after each collaboration phase (KT 2 and 3; see Figure 1). Each knowledge test comprised three different subtests to measure conceptual knowledge, representational transfer (Bodemer, 2011) and intuitive knowledge (Swaak, de Jong, & van Joolingen, 2004). All test items were designed as multiple choice questions, including one correct answer and three distractors.

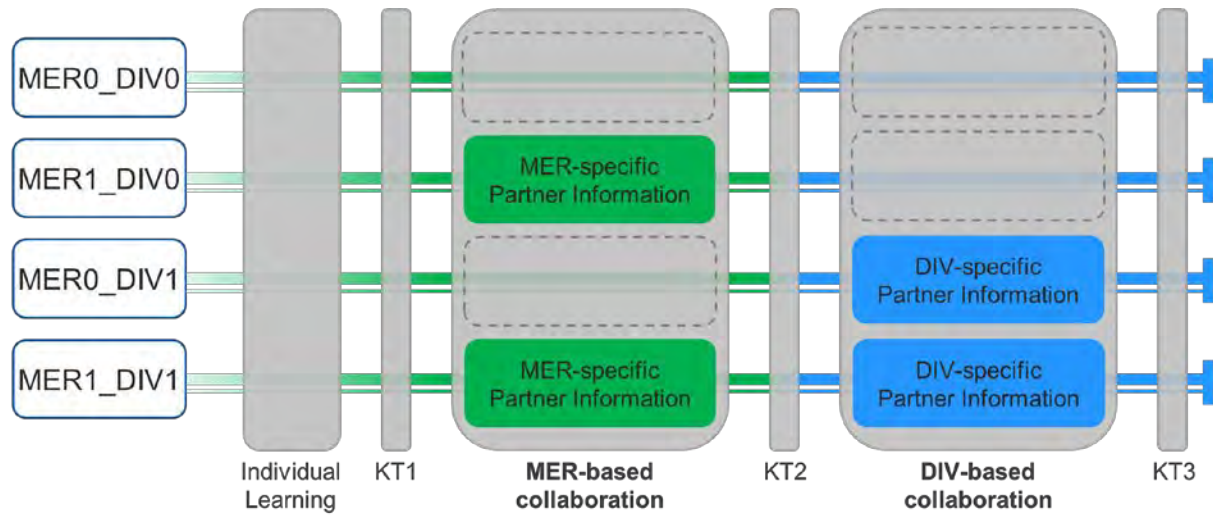

Figure 1. Experimental procedure differing with regard to four experimental groups.

2.2 MER-based Collaboration

Prior to the actual collaboration, each learner was requested to externalize her/his assumptions on MERs by individually integrating 13 formula-based elements into according parts of a static visualization via drag and drop. This integration task repeatedly proved to effectively support representational transfer and deep learning in individual MER-based learning scenarios (e.g., Bodemer, Ploetzner, Feuerlein, & Spada, 2004).

During the following first collaboration phase (15 minutes), learners were provided with differently coded learning material. The essential algebraic and visual elements were color-highlighted in all groups in order to keep the first CGA design feature invariant (see Figure 2a). To support partner modeling processes in two of the four experimental groups, each learner's prior assignments were presented to the respective learning partner (MER1_DIV1 and MER1_DIV0; see Figure 2b).

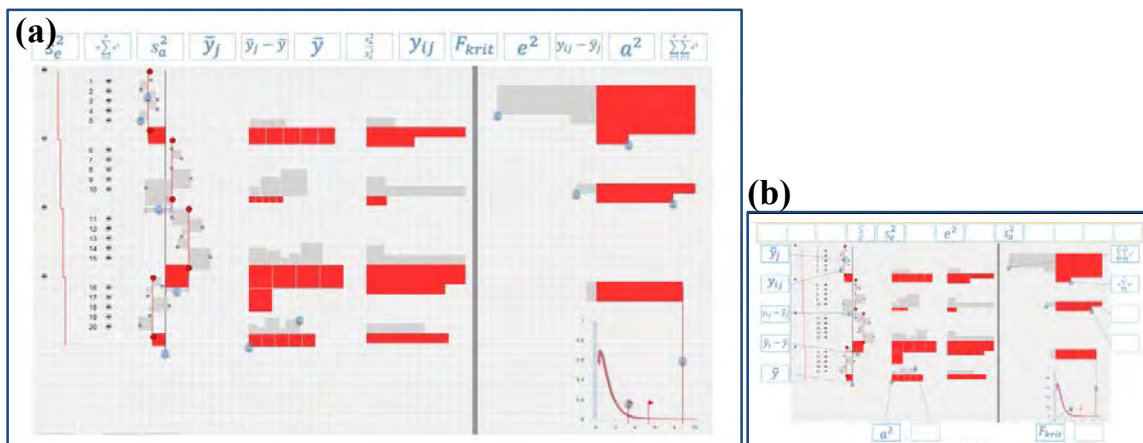

Figure 2. Screen captures of collaboration phase 1: (a) static multiple external representations (all experimental groups), (b) partner assignments (supported groups only).

As learners should not see their own assignments (enabling a comparison between own and partner information will be investigated in study 3), partner information was provided on additional laptops, which were arranged adjacently to the multi-touch tabletop.

2.3 DIV-based Collaboration

Analogous to the MER-based phase, learners externalized assumptions on the learning material in advance to the DIV-based collaboration phase. Each learner constructed eight hypotheses regarding interrelations of ANOVA elements using a set of predefined phrases (see Figure 3b). With respect to simulation-based discovery learning, a number of studies verified positive effects of supporting learners in generating hypotheses on collaborative processes as well as individual learning (e.g. Gijlers & de Jong, 2009; Scholvien & Bodemer, 2012; van Joolingen & de Jong, 1991).

In the following second collaboration phase (20 minutes), the visualization was enriched by several dynamic and interactive components, e.g. dragging a group mean to increase or decrease it. Essential causal relations between key elements of the ANOVA were provided beneath the animation (see Figure 3a), which, in a previous study, showed to beneficially affect learning partners' discourse as well as their individual learning outcomes (Scholvien & Bodemer, 2013). In addition, learners were provided with cognitive partner information in two of the four experimental groups. Each learner's prior hypotheses were presented to her/his respective learning partner (MER1_DIV1 and MER0_DIV1; see Figure 3b). Again, partner information was provided on additional laptops that were arranged adjacently to the multi-touch tabletop.

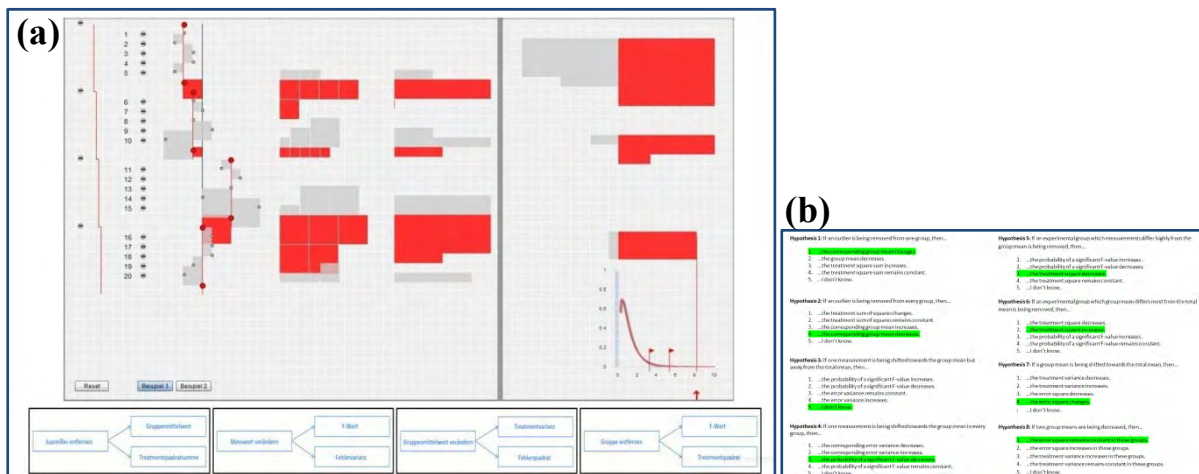

Figure 3. Screen captures of collaboration phase 2: (a) dynamic and interactive visualization (all experimental groups), (b) partner hypotheses (supported groups only).

2.4 Participants

In total, 120 university students (80 females and 40 males), aged 18-36 years ($M = 22.38$, $SD = 2.93$), were randomly paired into 60 dyads and subsequently randomly assigned to the four experimental groups. Participants were either paid or given a certificate needed for credits. All participants were recruited among students of a psychology-oriented degree program at the University of Duisburg-Essen, Germany, and had a basic knowledge of statistics concepts underlying the one-way analysis of variance.

3. Results

Due to the complex nature of the learning scenario, and to better comprehend the underlying individual and collaborative learning processes, a combination of qualitative and quantitative analyses has been applied to the data. Some analyses are still to be processed. However, essential results can be presented in the following.

3.1 Learning Outcomes

To investigate the effect of providing partner information on learning outcomes, individual learning was measured by three knowledge tests, which had to be performed prior (knowledge test 1) and subsequent (knowledge tests 2 and 3) to the collaboration phases. Each knowledge test was designed to measure conceptual knowledge, representational transfer, and intuitive knowledge. As intra-class correlations (Kenny, Kashy & Cook, 2006) regarding both post-knowledge tests revealed no interdependence within learning dyads, knowledge test scores were analyzed on an individual level.

With regard to prior knowledge (knowledge test 1), a two-way ANOVA with the factors *MER-specific partner information* (with vs. without) and *DIV-specific partner information* (with vs. without) showed no significant differences between the experimental groups (MER: $F(1, 116) = 0.58, p = .450, \eta^2 = .005$; DIV: $F(1, 116) = 0.02, p = .900, \eta^2 = .000$; MER x DIV: $F(1, 116) = 0.06, p = .801, \eta^2 = .001$). Equivalent ANOVAs were performed on knowledge tests 2 and 3 (for means and standard deviations see Tables 2 and 3).

After MER-based collaboration, particularly the main effect for providing MER-specific partner information is informative. As hypothesized, learners scored higher in knowledge test 2 (see Table 2) if they were provided with their learning partner's MER-assignments during the first collaboration phase ($F(1, 116) = 4.55, p = .035, \eta^2 = .038$). According to expectations, means did not differ significantly with regard to the presentation of *DIV-specific partner information* ($F(1, 116) = 0.02, p = .961, \eta^2 = .000$) and the interaction of both factors ($F(1, 116) = 0.12, p = .729, \eta^2 = .001$).

Table 2: Means and standard deviations for scores (%) in knowledge test 2 (after MER-based collaboration).

		MER-specific partner information				overall	
		yes		no			
		<i>M</i>	<i>(SD)</i>	<i>M</i>	<i>(SD)</i>	<i>M</i>	<i>(SD)</i>
DIV-specific partner information	yes	44.81	(19.24)	38.15	(20.15)	41.48	(19.82)
	no	46.30	(20.86)	37.04	(21.51)	41.67	(21.52)
	overall	45.56	(19.91)	37.59	(20.67)	41.57	(20.60)

Complementary to MER-based collaboration and knowledge test 2, after DIV-based collaboration (knowledge test 3; see Table 3) particularly the main effect for providing DIV-specific partner information is informative. As expected, learners provided with their learning partner's hypotheses outperformed those learners without CGA support in this learning phase ($F(1, 116) = 29.84, p < .001, \eta^2 = .205$). No significant differences occurred in this test regarding the factor *MER-specific partner information* (MER: $F(1, 116) = 0.33, p = .565, \eta^2 = .003$) and regarding the interaction of both factors (MER x DIV: $F(1, 116) = 0.03, p = .866, \eta^2 = .000$).

Table 3: Means and standard deviations for scores (%) in knowledge test 3 (after DIV-based collaboration).

		MER-specific partner information				overall	
		yes		no			
		<i>M</i>	<i>(SD)</i>	<i>M</i>	<i>(SD)</i>	<i>M</i>	<i>(SD)</i>
DIV-specific partner information	yes	57.59	(12.07)	56.48	(16.32)	57.04	(14.24)
	no	43.15	(18.78)	41.11	(11.36)	42.13	(15.42)
	overall	50.37	(17.26)	48.80	(15.95)	49.58	(16.57)

3.2 Partner Modeling

Providing partner information is expected to facilitate partner modeling, that is constructing a mental representation of the learning partner's assumptions. In order to estimate the modeling success, participants were asked to recall their learning partner's assumptions after each collaboration phase (MER-assignments after phase 1 and DIV-related hypotheses after phase 2). On this basis, the percentage of correctly memorized partner assignments could be determined. For means and standard deviations see Table 4 (assignments after MER-based collaboration) and Table 5 (hypotheses after DIV-based collaboration).

Analogous to the learning outcomes, learners performed better when they were provided with partner information in the respective collaboration phase (significant main effect for MER-specific partner information after MER-based collaboration: $F(1, 116) = 14.17, p < .001, \eta^2 = .109$; significant main effect for DIV-specific partner information after DIV-based collaboration: $F(1, 116) = 7.14, p = .009, \eta^2 = .058$).

Table 4: Means and standard deviations for correctly memorized partner assignments (%) after MER-based collaboration.

		MER-specific partner information				overall	
		yes		no			
		<i>M</i>	(<i>SD</i>)	<i>M</i>	(<i>SD</i>)	<i>M</i>	(<i>SD</i>)
DIV-specific partner information	yes	52.67	(25.45)	34.00	(21.11)	43.73	(25.04)
	no	49.33	(30.51)	32.67	(24.90)	41.00	(28.86)
	overall	51.00	(27.90)	33.33	(22.90)	42.17	(26.92)

Table 5: Means and standard deviations for correctly memorized partner hypotheses (%) after DIV-based collaboration.

		MER-specific partner information				overall	
		yes		no			
		<i>M</i>	(<i>SD</i>)	<i>M</i>	(<i>SD</i>)	<i>M</i>	(<i>SD</i>)
DIV-specific partner information	yes	43.33	(31.74)	38.89	(31.66)	41.11	(31.51)
	no	31.11	(23.05)	23.33	(26.48)	27.22	(24.92)
	overall	37.22	(28.19)	31.11	(29.98)	34.17	(29.14)

3.3 Interaction and communication behavior

To enrich the quantitative data on a deeper, more qualitative level, an insight into typical collaboration processes will be given. Therefore, the collaborative discourse of two learning dyads is illustrated and compared regarding prototypical interaction and communication patterns during their MER-based collaboration (with CGA support: Figure 4; without CGA support: Figure 5).

Figures show the communication and interaction sequence with regard to highlighted elements of the learning material (numbers in green circles) and the duration of each step of this sequence (circle size). For means of illustrating the collaborative discourse related to the learners' knowledge, all MER-assignments were added to the illustration even if they were not provided to the learners during collaboration. Assignments that were not visible to the learners are greyed out. Moreover, unequal MER-assignments (only one of the learners assigned a formula element to a particular visual element or both learners assigned different elements) are indicated by red dashed boxes.

The dyad provided with cognitive partner information (cf. Figure 4) interacted in a very structured way. First, the learning partners mainly searched for and addressed unequal assignments in the left part of the visualization (1-5), trying to clarify and solve knowledge-related conflicts. Then they continued with this systematic approach on the right and the lower right side of the visualization (6, 9-11) and thus managed to identify and discuss all unequal assignments during the first half of the

collaboration phase. After this initial work on unequal assignments, the two learners very briefly affirmed assignments they already agreed with each other. Finally, this learning dyad used the remaining collaboration time to revise the solutions regarding their initial unequal assignments (14-16), which led to a deep collaborative elaboration of involved concepts and high learning outcome.



Figure 4. Prototypic MER-collaboration sequence *with partner assignments* (numbers indicate sequence of discussion, circle size indicates duration of collaboration, assignments not visible to the learners are greyed out, unequal assignments are indicated by dashed boxes).



Figure 5. Prototypic MER-collaboration sequence *without partner assignments* (numbers indicate sequence of discussion, circle size indicates duration of collaboration, assignments not visible to the learners are greyed out, unequal assignments are indicated by dashed boxes).

Learners in the unsupported dyad (cf. Figure 5) did not use the given time just as effectively. Their learning discourse was not structured in terms of knowledge constellations, that is they did not focus on searching for and discussing divergent knowledge. Rather, learning partners clarified higher-level concepts (1-2) before systematically discussing the visualization from its left part (3-6, 9-11) via its bottom part (7, 9, 12) to its right part (13, 14, 17, 18). Thereby, this learning dyad spent more time and effort on talking about assumptions they already agreed on. Consequently, they failed to identify and discuss all unequal assignments and were not able to use the learning potential of discussing controversial positions thoroughly.

4. Discussion

The presented study was the second in a series of three experimental studies that investigate functions of cognitive group awareness tools in a complex collaborative multimedia learning scenario. Overall, it confirms the expected beneficial effects of providing knowledge related partner information on learning.

Regarding learning outcomes, in both collaboration phases learners provided with learning partner assignments performed significantly better than learners without additional collaboration support. However, this benefit was found for the respective collaboration phases only, indicating that there is no transfer effect for group awareness support from one collaboration phase with CGA support to a subsequent unsupported phase. Thus, providing cognitive information on the learning partner can support conceptual learning but does not seem to instruct useful metacognitive knowledge about grounding processes. Moreover, in contrast to findings regarding individual multimedia learning scenarios (e.g., Bodemer, Ploetzner, Bruchmüller & Häcker, 2005; Swaak, van Joolingen, & de Jong, 1998), higher representational and conceptual knowledge of supported learners after MER-based learning did not lead to better learning during subsequent collaboration with dynamic and interactive material.

Furthermore, it was hypothesized that providing cognitive partner information directly facilitates modeling processes of constructing a mental representation of the learning partner's knowledge or assumptions. This hypothesis was supported by an increased ratio of correctly reminded assumptions of the learning partner when learners were provided with CGA support. Supported learners seem to have better detected partner information and to have used it for efficient grounding processes and better learning.

Finally, a first, qualitative analysis of typical learning dyads demonstrates how learners provided with knowledge-related partner information can collaborate in a very systematic and beneficial way. They can successfully and effectively identify knowledge-related conflicts and, on this basis, engage in deeper, more elaborated communication. Although these data need to be analyzed in a much more comprehensive way, these first indications are consistent with a number of studies which emphasize the importance of negotiating knowledge-related conflicts (e.g. Mugny & Doise, 1978; Webb, 1989; Weinberger, Marttunen, Laurinen & Stegmann, 2013).

Overall, the results indicate that providing cognitive partner information supports different types of collaborative multimedia learning in many aspects. In addition to overall effects of GA tools (cf. Janssen & Bodemer, 2013) and to the beneficial function of cueing relevant information (Scholvien & Bodemer, 2013), the core feature of CGA tools showed positive effects on essential learning processes and learning outcomes. The third experimental study in this series will reveal whether the third proposed design feature (visualizing knowledge constellations for comparing learning partners) is as effective for collaborative multimedia learning as the two already investigated have shown to be.

Acknowledgements

This research was supported by the German Science Foundation (DFG – Deutsche Forschungsgemeinschaft) under research grant BO2511/5-1.

References

- Ainsworth, S. E. (2006). DeFT: A conceptual framework for learning with multiple representations. *Learning and Instruction, 16*(3), 183-198.
- Bodemer, D. (2011). Tacit guidance for collaborative multimedia learning. *Computers in Human Behavior, 27*(3), 1097-1086.
- Bodemer, D., & Dehler, J. (2011). Group awareness in CSCL environments. *Computers in Human Behavior, 27*(3), 1043-1045.
- Bodemer D., Kapur, M., Molinari, G., Rummel, N. & Weinberger, A. (2011). Towards a model of computer-supported collaborative learning with multiple representations. In H. Spada, G. Stahl, N. Miyake, & N. Law (Eds.), *Connecting Computer-Supported Collaborative Learning to Policy and Practice: CSCL2011 Conference Proceedings* (Vol. 3, pp. 1065-1072). International Society of the Learning Sciences.
- Bodemer, D., Ploetzner, R., Bruchmüller, K., & Häcker, S. (2005). Supporting learning with interactive multimedia through active integration of representations. *Instructional Science, 33*(1), 73-95.
- Bodemer, D., Ploetzner, R., Feuerlein, I., & Spada, H. (2004). The active integration of information during learning with dynamic and interactive visualizations. *Learning and Instruction, 14*(3), 325-341.
- Bromme, R., Hesse, F. W., & Spada, H. (2005). Barriers, biases and opportunities of communication and cooperation with computers: Introduction and overview. In R. Bromme, F. W. Hesse, & H. Spada (Eds.), *Barriers and biases in computer-mediated knowledge communication – and how they may be overcome* (pp. 1-14). New York: Springer.
- Clark, H. H., & Brennan, S. A. (1991). Grounding in Communication. In L. B. Resnik, J. M. Levine, & S. D. Teasley (Eds.), *Perspectives on socially shared Cognition* (pp. 127-149). Washington: APA Books.
- de Jong, T., & van Joolingen, W. R. (1998). Scientific discovery learning with computer simulations of conceptual domains. *Review of Educational Research, 68*(2), 179-201.
- Dillenbourg, P., & Bétrancourt, M. (2006). Collaboration Load. In J. Elen, & R. E. Clark (Eds.), *Handling Complexity in Learning Environments: Theory and Research* (pp. 142-163). Amsterdam: Elsevier.
- Mugny, G. & Doise, W. (1978). Socio-cognitive conflict and structure of individual and collective performances. *European Journal of Social Psychology, 8*, 181-192.
- Gijlers, H., & de Jong, T. (2009). Sharing and confronting propositions in collaborative inquiry learning. *Cognition and Instruction, 27*(3), 239-268.
- Janssen, J., & Bodemer, D. (2013). Coordinated computer-supported collaborative learning: Awareness and awareness tools. *Educational Psychologist, 48*(1), 40-55.
- Kenny, D. A., Kashy, D. A., & Cook, W. L. (2006). *Dyadic data analysis*. New York, NY: Guilford.
- Oestermeier, U., & Barquero, B. (2001). *VANOVA: Eine Veranschaulichung der Varianzanalyse [Visualized ANOVA]*. Available: <http://vanovaapp.appspot.com> [01.05.2014].
- Ogata, H., & Yano, Y. (1998). Knowledge awareness: Bridging learners in a collaborative learning environment. *International Journal of Educational Telecommunications, 4*(2/3), 219-236.
- Scholvien, A., & Bodemer, D. (2012). Cognitive group awareness support for collaborative discovery learning. In M. Pedaste, A. Wichmann, & M. Mäeots (Eds.), *Computer-Supported Inquiry Learning Conference - Promoting Science Through Inquiry: EARLI SIG20 2012 Conference Proceedings* (pp. 29-30). Bochum: Ruhr University Bochum.
- Scholvien, A., & Bodemer, D. (2013). Information cueing in collaborative multimedia learning. In N. Rummel, M. Kapur, M. Nathan, & S. Puntambekar (Eds.), *To see the world and a grain of sand: Learning across levels of space, time and scale: CSCL2013 Conference Proceedings* (Vol. 2, pp. 149-152). International Society of the Learning Sciences.
- Swaak, J., de Jong, T., & van Joolingen, W. R. (2004). The effects of discovery learning and expository instruction on the acquisition of definitional and intuitive knowledge. *Journal of Computer Assisted Learning, 20*(4), 225-234.
- Swaak, J., van Joolingen, W. R., & de Jong, T. (1998). Supporting simulation-based learning: The effects of model progression and assignments on definitional and intuitive knowledge. *Learning and Instruction, 8*(3), 235-253.
- van Joolingen, W.R., & de Jong, T. (1991). Supporting hypothesis generation by learners exploring an interactive computer simulation. *Instructional Science, 20*(5-6), 389-404.
- Webb, N. M. (1989). Peer interaction and learning in small groups. *International Journal of Educational Research, 21*(4), 576-602.
- Weinberger, A., Marttunen, M., Laurinen, L., & Stegmann, K. (2013). Inducing socio-cognitive conflict in Finnish and German groups of online learners by CSCL script. *International Journal of Computer Supported Collaborative Learning, 8*(3), 333-349.

The appropriation of a representational tool in the second language classroom

Yun WEN^{a*}, Wenli CHEN^b & Chee-Kit LOOI^b

^a*Computer-human Interaction in Learning and Instruction (CHILI) Lab, EPFL, Switzerland*

^b*National Institute of Education, Nanyang Technological University, Singapore*

*yun.wen@epfl.ch

Abstract: This case study investigates the appropriation of a representational tool by students in small groups in the context of collaborative second language writing. The functions of inscriptional devices in second language classroom learning are identified: (1) referencing, (2) pinpointing, (3) accumulating, (4) prompting notice, (5) realizing parallels, and (6) promoting synergy. The study explores the beneficial affordances of the representational tool that supplement face-to-face communication for second language learning, and draws some implications for the design of collaborative L2 learning in networked classrooms.

Keywords: Representational tool, Networked Classroom learning, CSCL, Computer-supported language learning

1. Introduction

Computer-supported language learning has received attention since computers have been used for word processing, and has developed rapidly with the availability of online technologies. The use of computer-supported collaborative learning is more and more commonplace in language learning classrooms (Dooly, 2011). Technical artifacts can augment spoken and gestural communication between copresent collaborators (Roschelle, 1994; Suthers, Girardeau, & Hundhausen, 2003), and they can be embedded in classrooms where face-to-face communication is still a main channel for interaction (Lingnau, Hoppe, & Mannhaupt, 2003).

In recent years, a kind of generic representational tool—Group Scribbles (GS), which consists of a graphical shared workspace—has been codeveloped for enabling collaborative generation, collection, and aggregation of ideas through a shared space based on individual efforts and social sharing of notes in graphical/textual forms (for more information, see SRI International, <http://groupscribbles.sri.com/>). The educational benefits of representational tools have been recognized, such as when selecting relevant information, organizing information into coherent formats, or relating it to prior understanding (e.g., Liu, 2011; Stull & Mayer, 2007). Yet most of the studies focus on reporting the positive or negative effects of them on the students' learning performance or learning motivations (Hwang et al., 2014) or accentuate how to design or script a representational tool in online learning. Less attention (Overdijk & van Diggelen, 2008, as an exception) is paid to how groups of learners appropriate a representational tool in a classroom environment in which face-to-face communication is an integral part of the learning interactions, and to how technical artifacts mediate face-to-face communication.

Situated in a Chinese as second language (L2) learning classroom setting equipped with GS, the study aims to explore the beneficial affordances of the representational tool that supplement face-to-face communication for *group understanding development* (in this study, it is an operational definition of group's collective thinking for judging group performance, including both mutually and partially shared meaning) in L2 learning classrooms, and thus provides insights to task/script design and enactment of collaborative L2 learning in networked classroom environments where face-to-face and online interactions are intertwined.

2. Literature Review

2.1 Use of representational tools

Prior research on CSCL has highlighted the importance of representational aids, such as dynamic notations, knowledge maps, and simulation for collaborative learning performance (Fischer et al., 2002; Janssen et al., 2008; Slob et al., 2010; Wegerif et al., 2010). Embedding representational tools in a CSCL environment can facilitate students' construction of multimodal representations of the domain knowledge and thereby guide their interactions (Slob et al., 2010). Through representing ideas and understandings on the shared work space, students' thinking is made public and exposed to critical scrutiny, during which cognitive development can occur (Liu & Kao, 2007). Suthers and Hundhausen (2003) have concluded that external representations play at least three roles that are unique to situations in which a group is constructing and manipulating shared representations as part of a cognitive activity. They are: (1) initiating negotiation of meaning; (2) serving as representational proxy for purposes of gestural deixis (reference to an entity relative to the context of discourse by pointing) rather than verbal descriptions; and (3) providing a foundation for implicitly shared awareness. Although the educational benefits of representational tools are widely recognized, some studies report mixed or even negative findings and thus question how students' interaction can best be guided (e.g., Bera & Liu, 2006; Elen & Clarebout, 2007).

In accordance with other computer-mediated communication tools used in education, the presence of a representational tool in the classroom alone does not automatically benefit students' learning (Slob et al., 2010). A given tool offers affordances that may influence how learners engage in knowledge construction (Kozma, 2003; Suthers & Hundhausen, 2003) but do not causally determine their learning outcomes (Hakkarainen, 2009; Medina & Suthers, 2012). Technology does not determine the nature of its implementation but coevolves with gradually transforming instructional practices (Tuomi, 2002). Learners can appropriate the multimodal resources for their own purposes, and this appropriation (as well as the influence of the technology) can develop over time (Medina & Suthers, 2012). Even though there are stable characteristics of tools that are generalizable over different settings, the tools can be appropriated in unexpected ways (Dwyer & Suthers, 2006; Overdijk & van Diggelen, 2008). Different groups evolve alternative approaches to representational practices with the affordances of representational tools (Larsson & Alterman, 2007). It is like what Carrol et al. (2002) pointed out that appropriation can be seen to be a process which combines technological determinism (that affords and constrains certain activities and partly determines the boundaries around the activities that are possible) with social shaping within these boundaries. Only when collaborative technologies (including representational tools) have been fully fused with social practices of teachers and students, are their intellectual resources genuinely augmented and learning achievements correspondingly facilitated (Hakkarainen, 2009). Therefore, this study focuses on analyzing how the GS representational tool was brought into use in a good lesson.

2.2 Analytic frameworks for investigating interaction in CSCL

During the past decade, analytic frameworks and approaches for analyzing interaction in CSCL have been getting increasingly sophisticated. It is posited that the methodological uniqueness of CSCL research "is reflected in the several approaches that have been put forth to document and analyze collaborative interactions" (Puntambekar et al., 2011, p. ix). These frameworks/techniques are used for examining interactions in different representational formats (e.g., forum-based or mapping-based) and with different analytic foci and assumptions about what it means for participants to achieve a conceptually deeper level of interaction.

As whether only the temporal issue (or the chronological dimension) is taken into account, they can be classified into two major categories: (1) the nature of the function of participants' contributions in the dialogue and (2) patterns and trajectories of participant interaction. Besides, the bulk of the analytical frameworks/techniques are applied to examine interaction happening in a single dialogue-based interaction environment, and only a few revolve around interaction happening in dual-interaction spaces (e.g., Hmelo-Silver et al., 2011; Suthers & Rosen, 2011). Furthermore, none of them is specific for analyzing interaction in language learning. In the study reported here, open coding is adopted.

3. Methods

This case study was derived from a 5-year project that integrates GS in language learning for sustaining collaborative activities in language learning classrooms. The “ideal” case lesson was the last GS lesson of a semester. This lesson was selected in terms of the reflection from the teacher and students. As the teacher mentioned her post-lesson interview “today’s lesson is completed smoothly as we planned...”

3.1 Participants

The subjects of this study were from a class of a secondary school (Grade 8). The class consists of 6 female students and 13 male students (aged from 14-16). In every GS lesson, these 19 students were separated into five groups based on their previous school examination scores for the Chinese language subject. A comparative high-ability group, a medium-ability group, a comparative low-ability group, and two mixed-ability groups were formed. In order to build and sustain the group culture, the group compositions remained unchanged from the beginning stage till the end of the implementation of this study. The last GS lesson was selected on the assumption that the teacher and students had developed familiarity with GS-based collaborative activities.

3.2 Learning environment and the activity design

Figure 1 shows the GS classroom environment where 3-4 students sitting in groups, and each of them had their own laptop to access and use the GS tool. An Interactive Whiteboard was set up in front of the classroom to help the teacher to visualize and monitor the interaction processes of every single group.



Figure 1. GS classroom environment

The lessons were about collaborative L2 writing. The main learning objective of the lesson reported in this paper was to help students understand that an argumentative essay can be conceptualized and composed from exploring the contributing factors of a phenomenon, followed by finding its impacts and providing solutions if needed. In the GS tool, a template (Figure 2) was uploaded as the background in order to provide tangible scaffoldings for students to follow the teacher’s instruction (Wen, Chen & Looi, 2011) and to allow them to pay attention to the three elements (cause, consequence, and solution) necessary in writing an argumentative essay.

整容现象产生的原因:	这一现象导致的后果:	解决方法:
Causes	Consequences	Solutions

Figure 2. A graphic organizer for the planning task

3.3 Data collection and analysis

The main data sources for this study were the video data of the face-to-face and GS-based interactions in the various groups. In addition to video cameras, the iShowU screen-capturing was installed on every student's MacBook to record all the actions of individual students on the computers, as well as their verbal talks and facial expressions.

For the data analysis, all the video data were first transcribed verbatim, synchronized and presented chronologically. Then all the interaction data were coded on the multiple levels with different dimensions. At the macro-level, the interaction data were coded back and forth with two dimensions: the medium and functions of interactions using the unit of "event". "Event" in this study referred to a series of uninterrupted interaction moves with the same semantic content that happened through the same medium. It could be a two minutes long conversation as long as the participants were talking about the same topic unceasingly. It also could be as short as one verbal sentence or a single GS posting.

This study aims to investigate students' interactions across face-to-face and online interactional spaces. Student's interactions in the unit of event were categorized into face-to-face-based and GS-based in terms of medium, and then these events were further categorized in terms of the *function* performed to complete the task: whether it is social-related or cognitive-related. Additionally, as the study is focused on exploring the trajectories of group understanding development, any events regarding off-task issues, such as technical problems, jokes, greetings etc., would not be included in the data analysis of this study. In view of these, all the events were classified into three categories related to functions performed to complete the task: cognitive-related, social-related, and off-task. In the study, the "social-related" category termed as "Regulation", refers to interactions about regulating and coordinating group work. Taking account of the characteristics of L2 learning, the "cognitive-related" interactions were further categorized into two sub-categories: Content-related and Language-related. These categories were established as the result of a repeated process of iterating back and forth between theory and data (Onrubia & Engel, 2012).

Diagram Representation		Content	Participants	Note & Interpretation
GS	Face-to-face			
3G1	3C4	<ul style="list-style-type: none"> ➤ T: 这边呢? 分类怎么样了? [How about here? How about your classification?] ➤ William: 我们用那个“五指山”来分类。 [We classified based on “Five fingers”.] ➤ T: 对, 五指山。对, 所以呢? [Yes, “Five fingers”. All right, then?] ➤ William: 我们有对自己不满, 比如说对自己不满, 嗯, 还有家庭的原因。 [We have “not satisfied with own appearances”. Eh, also have reasons from the family perspective.] ➤ T: 家庭会有什么原因啊? 什么原因会是家庭的? [What kind of reasons from the family perspective? What kind of reasons belongs to the family's] ➤ William: 嗯... [Eh...] ➤ Sophia: 家庭也可以是兄弟姐妹的事。 [It could be about brothers or sisters.] ➤ T: 对, 可以写兄弟姐妹的影响。 [Yes, can write something effects from brothers and sisters.] 	Teacher, William, and Sophia	<ul style="list-style-type: none"> ❖ When Group 3 was on the point of re-organizing their existing postings, the teacher intervened and asked the students about their work progress. ❖ William responded to the teacher that they had contributed some ideas from “the personal perspective”, but it is worth noting that “reasons from the family perspective” never occur in this group's previous discussion. It seems that this a new idea that has popped up in William's own mind.
	3R4	<ul style="list-style-type: none"> ➤ Sophia: 我来, 我写。 [I do it, I write it] 	Sophia	
3G7		<p style="text-align: center;">[Because people (friends or families) like to compare him with his brothers and sisters. E.g., saying the elder brother is more handsome than the younger.]</p> <p style="background-color: #e0f0ff; padding: 5px;">因为人(朋友/家庭)一直把他跟兄弟姐妹一起比。比如: 说哥哥比弟弟帅。</p>	Sophia	

Legend:

3G1 refers to group 3's first GS posting (the small rectangle in broken link means the posting is not newly created).

3G7 refers to group 3's seventh GS posting

3C4 refers to group 3's fourth Content-related verbal conversation

3R4 refers to group 3's fourth Regulation-related verbal conversation

Figure 3. Diagram for analyzing across-media interaction at the micro-level

Coding on the macro-level provided an objectively “first pass” about the interaction distribution. Then on the micro-level, the interaction sequences and contextual information were taken into consideration in coding. A kind of diagram was created to visualize the sequence of interaction events and their relations (Figure 3). As shown in the figure, the flow from top to down denotes the time sequence. GS postings and verbal conversations are presented in two separated columns. Their content is shown in the central big column. The information regarding participants, media and functions of interactions could be obtained from the diagram directly. Two other concepts were proposed to help identify the medium transition (interactions happened across different media). One is “*cross-media adjacency events*”. These are represented in solid lines with arrow, to signify the adjacent cognitive meaningful events spanning different medium spaces. The other is “*cross-media responses*” which indicate that those cross-media interactional moves happened between GS postings and social-related/off-task events (represented in broken lines). They are represented by dotted in the diagram. In this study, we focused mainly on “cross-media adjacency events”.

In sum, this is a pre-dominantly qualitative case study. Quantitative information about interaction distribution in different small groups is mainly provided to help select and interpret the interesting excerpts for micro-level analysis.

4. Findings

4.1 Interactions with various content via different media

Table 1 shows the medium distribution of the interactions in different groups. In addition, the results noted that task management-related communication or coordination, and even off-task interactions, did not occur in the GS environment. That meant the GS environment mainly served as a shared external memory where the group kept a record of shared understandings. Face-to-face interactional event, however, could be classified into different categories of function (see Table 2).

Table 1: Description of group interactions in different media spaces

Group \ Medium	Homogeneously high-ability group	Heterogeneously high-ability group	Homogeneously middle-ability group	Heterogeneously middle-ability group	Homogeneously low-ability group	Total
No. of face-to-face interactional events	102 (25.95%)	95 (24.17%)	72 (18.32%)	71 (18.07%)	53 (13.49%)	393 (100%)
No. of GS postings	51 (34.23%)	21 (14.09%)	18 (12.08%)	31 (20.81%)	28 (18.79%)	149 (100%)

Table 2: The distribution of face-to-face interactional events in different groups (N =393)

Group \ Function	Homogeneously high-ability group	Heterogeneously high-ability group	Homogeneously middle-ability group	Heterogeneously middle-ability group	Homogeneously low-ability group	Mean (SD)
Content-related	48 (47.1%)	38 (40.0%)	27 (37.5%)	27 (38.9%)	27 (50.9%)	33 (9.628)
Language-related	3 (2.9%)	5 (5.3%)	11 (15.3%)	9 (12.7%)	6 (11.3%)	7 (3.535)
Regulation	39 (38%)	45 (47%)	26 (36%)	31 (44%)	16 (30%)	15 (8.031)
Off-task	12 (11.8%)	7 (7.4%)	8 (11.1%)	4 (5.6%)	4 (7.5%)	7 (3.317)
Total	102 (100%)	95 (100%)	72 (100%)	71 (100%)	53 (100%)	78 (19.83)

The quantitative data suggested that all the groups actively participated in completing the task (mean of Off-task =7, SD =3.317). The empirical data showed that group language competency influenced the way in which the representational tool was appropriated. The results indicated that group language proficiency restricted L2 learners’ involvement in verbal talk, especially when they were encouraged to communicate in the target language. Yet its influence on their involvement in online interaction was not so compelling (shown in Table 2). Groups with higher language proficiency tended to focus more on content-related knowledge talk than on language-related knowledge talk (shown in Table 2).

4.2 Interplay between medium transition and group understanding development

Zooming in on the co-construction process of group inscriptions, the analysis of both cross-media adjacency events and cross-media responses helps to identify the semantic and temporal relationship among face-to-face and GS-mediated interactions and to understand the kind of situations in which group understanding development occurred more effectively. Beyond the understanding that the representational tool served as an external shared space where small groups kept a record of shared thinking (Suthers & Hundhausen, 2003), the role of inscriptional devices in group understanding development was further identified and demonstrated through the qualitative microanalysis of the interactions. In this sense, the findings revealed the fabrics of common ground in a classroom environment with representational tools. Table 3 shows a summary of the patterns of medium transition, their corresponding trajectories of group understanding development, and the role of inscriptional devices functioned.

Table 3: the summary of findings

Pattern of medium transition	Trajectories of group understanding development	The role of inscriptional devices
GS→CONT	<ul style="list-style-type: none"> Provide comments towards the existing posting but without changing its content. 	Referencing
GS→LANG	<ul style="list-style-type: none"> Inquire about the pronunciation or meaning of specific characters/phrases relevant to the posting. 	Pinpointing
GS→ CONT (LANG) →GS	<ul style="list-style-type: none"> Read out the written content of an inscription. Promote verbal discussion by pointing out the improper content in the inscription or the content that could be better written, or providing a new idea relevant to the inscription. Pool knowledge to polish the sentence/idea, and reach a consensus. Language-related problems may emerge in content-related discussion, and they can be solved implicitly or explicitly. Complete/repeat the sentence verbally. Type out the sentence without any change in GS. 	Promoting synergy
CONT (LANG) → GS	<ul style="list-style-type: none"> Attempt to start a topic with fragmented words or phrases. Assemble or link words/phrases into a complete sentence without explanations. (Language-related problems may be proposed and solved in this process as byproducts). Type out the sentence verbatim in GS. 	Accumulating
CONT (LANG) → GS	<ul style="list-style-type: none"> Verbalize individual ideas. Help one another to express ideas clearly and precisely, involving questioning, interpreting, exemplifying etc. Organize and summarize the ideas that have been co-constructed in verbal form. Translate the summarized ideas into text concurrently. 	Realizing parallels
LANG → GS	<ul style="list-style-type: none"> Ask for help explicitly to complete the text, when a student needs to express an idea to start or continue his/her work. Collect informative linguistic knowledge to translate content, and reach a consensus once a “correct” answer is given. During this process, students are able to clarify the ideas that they would like to externalize and their understanding on the ideas from others. Transform the idea into an inscription. 	Prompting notice

According to the empirical data gained, when the inscriptional device functioned as *referencing*, *pinpointing*, or *accumulating*, the corresponding interactional moves were comparatively less cognitively demanding. Contrarily, when the role of inscriptional devices functioned as *promoting synergy*, *realizing parallels*, or *prompting notice*, the corresponding interactional moves were more cognitively demanding and more productive group interactions occurred, because students engaged in

searching information, explaining, elaborating, and summarizing. It has been widely reported in educational literature that such kind of cognitive engagement requiring higher-order-thinking skills is critical to meaningful learning (e.g., Zhu, 2006). Nevertheless, as observed, this is not always the case that groups with higher language proficiency more frequently draw upon the inscriptional device as *promoting synergy*, *realizing parallels*, or *prompting notice* in group understanding development.

The quantitative data above indicated that group language proficiency influenced the occurrence frequency of language-related talk. Theories of second language learning (e.g., the Noticing Hypothesis from Schmidt, 1990, and the Output Hypothesis from Swain, 1985) have emphasized that the learner's attention to language as an object while engaged in communication is beneficial for L2 learning. Two patterns of medium transition relating to language-related talk and their effects on a small group's L2 development were distinguished. Corresponding to the pattern of medium transition—LANG→GS—the role of inscriptional devices in group understanding development was *prompting notice*. The activity of producing the target language on GS space prompted students to consciously recognize some of their linguistic problems, and this triggered cognitive processes in which group members co-constructed or consolidated their existing linguistic knowledge and created a new posting that was accepted by all of them. Corresponding to the pattern of medium transition—GS→LANG—the inscriptional device functioned as *pinpointing*, which had an emphasis on prompting individuals to inquire about the pronunciation or meaning of specific characters/phrases on the posting. Since no subsequent improvement or creation of a new group inscription can be observed in this pattern, it is difficult to judge whether the mutual understanding is successfully established by all group members. In other words, when the role of inscriptional devices functions as *pinpointing*, group understanding development can be observed but its effectiveness cannot be guaranteed.

The qualitative microanalysis of interaction also revealed that language-related talk often intertwined with content-related talk. Once verbal talk went beyond language-related knowledge, the talk would not be dominated by the authoritative group members, and hence all the members could have comparatively equal opportunities to contribute to their group work. Instead of solely compensating for deficient language-related knowledge, students constantly ventured new ideas and updated their common ground. In such a process, more language-related problems might emerge. Along with this, they effectively constructed and consolidated understanding of both content-related knowledge (including understanding of the given topic and the writing strategy) and language-related knowledge. Nevertheless, it is also worth mentioning that even though corresponding to the same pattern of medium transition, the inscriptional device can function differently. As summarized in Table 3, they can function as accumulating and realizing parallels in the pattern of medium transition—CONT→GS. The data indicated that when the inscriptional device functioned as *accumulating*, the group understanding development seemed less productive. This is because students initially had no clear idea about what they intended to express and they did not seek to find out and fill gaps in their knowledge resources. However, in some cases, students co-constructed ideas from different perspectives through developing an intersubjective orientation toward one another based upon exploratory talk, and then rendered their individual ideas simultaneously. In doing so, productive group understanding development occurred and the role of inscriptional devices was *realizing parallels*. Besides, the role of inscriptional devices as *promoting synergy* in the pattern of medium transition—GS→CONT→GS, which contrasts with its role as accumulating in CONT→GS, put an emphasis on online inscriptions, which are more persistent and may be from other groups, rather than only ephemeral intragroup verbal talk.

The data drawn from cross-media adjacency events also indicated that the role of inscriptional devices was task sensitive. For example, at the first phase of the task, the students were encouraged to provide their own ideas in an initial text. In doing so, the inscriptional device mainly functioned as referencing or pinpointing. At the final phase of the task, however, the students were required to discuss with one another, modify existing inscriptions and create truly shared group inscriptions as products of their collaborations. Even though different small groups still appropriated GS in different ways, the inscriptional device functioned more as promoting synergy, realizing parallels, or prompting notice in more productive group understanding development in all groups. In other words, there was not just one way to utilize the tool to perform the task, and the students were required to make choices.

5. Discussion and Conclusion

Situated in a setting of L2 learning, this study focused on investigating the appropriation of a representational tool in the classroom at the level of the small group. A major concern of this study was to examine how small-group task completion is contingent on cross-media interactions, to explore the temporal scope of this contingency as mediated by persistent inscriptions. The case was selected and investigated when the participants have truly gone through the expansive learning that is required for cultivation of novel computer-mediated collaborative practices of working creatively with knowledge.

The study established a connection between the pattern of medium transition and the trajectory of group understanding development, what was investigated through cross-media adjacency events. The results indicated that using the representational tool—GS in L2 classrooms—is beneficial for collaborative language learning. Empirical data evidenced that different small groups evolved alternative approaches in carrying out the tasks; group language competency, and task design influenced the way in which the representational tool was appropriated. The inscriptional device had significant effects on the students' interactions and had different influences on group understanding development. Stated succinctly, this study provided empirical data to illustrate some of the mutual influences between the tool and the participants.

According to the findings, a number of beneficial features of the representational tool supplementing rather than substituting face-to-face communication within a single language learning class can be summarized. Here we need not elaborate any further on the obvious advantages of online representational effects on enlarging the bandwidth of resource sharing, compared to the traditional use of pen and paper (e.g., the convenience of intergroup interaction without physical movement). The beneficial features of the online representational tool are elaborated by emphasizing its complementary role in the improvement of L2 learning in a classroom environment.

First, *online interaction tends to feature more balanced participation than face-to-face discussion, and online interaction is juxtaposed with face-to-face interaction, and thus students with higher language proficiency are less likely to dominate the group work.* The observation made in this study indicated that all small groups, regardless of their language proficiency, were willing to externalize their ideas or to help improve postings from others, whereas group language proficiency restricted their involvement in verbal talk, especially when asked to communicate in the target language. This result is consistent with the literature on computer-assisted language learning which shows that L2 learners tend to participate more equally and take more risks to experiment with ideas (try more creative ideas) in online environments than in traditional face-to-face classroom environments (e.g., Warschauer, 1999).

Second, *embedding representational tools in classroom learning empowers students to notice their linguistic problems and incorporate knowledge from others to solve problems, and meanwhile the shared space for the co-construction of group output (inscriptions) gives way to discussion about and justifications of representational acts as well as inducing knowledge sharing.* The results indicated that the activity of producing inscriptions in the target language prompted students to consciously identify gaps in their own knowledge, and this triggered cognitive processes in which group members co-constructed or consolidated their existing linguistic knowledge and generated a new posting that was accepted by all of them through verbal discussion (e.g., in the pattern of medium transition LANG→GS, the inscriptional devices function as prompting notice). Therefore, in the context of language learning, the co-construction of inscriptions can be deemed as “writing to learn” (Williams, 2012), which promotes learning content knowledge as well as knowledge about the language (Hirvela, 1999). Previous literature has found that compared to other forms of language use, written record pushes learners to demand greater precision, which may encourage them to consult their explicit knowledge (Williams, 2012).

Third, *the contributed inscription reminds participants of previous ideas and initiates elaboration or negotiation on them, and possibly serves as resources for the emergence of new ideas/perspectives.* In this case study, we see the high frequency of occurrence of the medium transition from GS inscriptions to face-to-face discussions, and some of them are accompanied by the creation of new GS inscriptions. The qualitative microanalysis of interaction has suggested that group understanding develops productively in the pattern of medium transition—GS→CONT→GS, where the inscriptional device plays a role as promoting synergy. In semiotic terms, the inscriptions are representations not by reference to fixed concepts but by being in contextually defined relations to the situation at hand (Goodwin, 2003). Therefore, it is explained that the persistent inscription providing semiotic resource evokes and facilitates subsequent negotiations of meaning (Medina & Suthers, 2012;

Suthers & Hundhausen, 2003). On the contrary, when the group's verbal talk takes place without referencing to a prior inscription, the group understanding development is usually less productive as participants construct inscriptions without contextually making meaning (e.g., in the pattern of medium transition CONT→GS, the inscriptional devices function as accumulating).

In sum, the results of the study add to a growing research indicating the effects of representational tools on learning (especially on L2 learning). It is emphasized that the use of representational tools or the high frequent medium transitions does not necessarily imply that learning is effectively taking place. Exploring and understanding the specific functions of inscriptional devices in depth and in situ help us reflect on some of the practical implications of the findings and the discussion above for suggesting pedagogical design improvements by integrating a representational tool such as GS to facilitate language learning. However, this case study does not aim at predicting that all the identified functions will be played out in all the representational tool-supported L2 learning contexts. The scope of the study is limited to the examination of interactions that occurred among a class of small groups of students. As a result, the major limitation of the study is about the generalizability of the findings. In order to generalize the findings, there is a necessity to examine the appropriation of the representational tool in other lessons, with diverse task designs.

References

- Bera, S., & Liu, M. (2006). Cognitive tools, individual differences, and group processing as mediating factors in a hypermedia environment. *Computers in Human Behavior*, 22, 295–319.
- Carroll, J., Howard, S., Vetere, F., Peck, J., & Murphy, J. (2002). Just what do the youth of today want? Technology appropriation by young people. *Proceedings of the 35th Hawaii International Conference on System Sciences*.
- Dooly, M. (2011). Divergent perceptions of telecollaborative language learning tasks: Task-as-workplan vs. task-as-process. *Language Learning & Technology*, 15(2), 69-91.
- Dwyer, N., & Suthers, D. D. (2006). Consistent practices in artifact-mediated collaboration. *Computer-Supported Collaborative Learning*, 1, 481-511.
- Elen, J. & Clarebout, G. (2007). Supporting learning: increasing complexity? *Computers in Human Behavior*, 23, 1162–1166.
- Fischer, F., Bruhn, J., Gräsel, C., & Mandl, H. (2002). Fostering collaborative knowledge construction with visualization tools. *Learning and Instruction*, 12, 213–232.
- Goodwin, C. (2003). Pointing as situated practice. In S. Kita (Ed.), *Pointing: Where language, culture and cognition meet* (pp. 217–241). Mahwah, NJ: Erlbaum.
- Hakkarainen, K. (2009). A knowledge-practice perspective on technology-mediated learning. *Journal of Computer-Supported Collaborative Learning*, 4, 213-231.
- Hmelo-Silver, C. E., Jordan, R. Liu, L., & Chernobilsky, E. (2011). Representational tools for understanding complex computer-supported collaborative learning environments. In S. Puntambekar, G. Erkens, & C. Hmelo-Silver (Eds.), *Analyzing interactions in CSCL: Methods, approaches and issues* (pp. 83-106). New York, NY: Springer.
- Hirvela, A. (1999). Collaborative writing instruction and communities of readers and writers. *TESOL Journal*, 8(2), 7–12.
- Hwang, G.-J., Kuo, F.-R., Chen, N.-S., & Ho, H.-J. (2014). Effects of an integrated concept mapping and web-based problem-solving approach on students' learning achievements, perceptions and cognitive loads. *Computers & Education*, 71, 77-86.
- Janssen, J., Erkens, G., & Kirschner, P. A., Kanselaar, G. (2008). Effects of representational guidance during computer-supported collaborative learning. *Instructional Science*, 38, 59-88.
- Kozma, R. (2003). The material features of multiple representations and their cognitive and social affordances for science understanding. *Learning and Instruction*, 13(2), 205-226.
- Larsson, J. A., & Alterman, R. (2007). Tracking online collaborative work as representational practice: Analysis and tool. In the *3rd International Conference on Communities and Technologies*, Michigan State University, East Lansing, Michigan
- Lingnau, A., Hoppe, H. U., & Mannhaupt, G. (2003). Computer supported collaborative writing in an early learning classroom. *Journal of Computer Assisted Learning*, 19(2), 186-194.
- Liu, C. C. & Kao, L. C. (2007). Do handheld devices facilitate face-to-face collaboration? Handheld devices with large shared display groupware to facilitate group interactions. *Journal of Computer Assisted Learning*, 23(4), 285-299.

- Liu, P. L. (2011). A study on the use of computerized concept mapping to assist ESL learners' writing. *Computers & Education*, 57, 2548-2558.
- Medina, R., & Suthers, D. (2012). Inscriptions becoming representations in representational practices. *Journal of Learning Sciences*, 22, 33-69.
- Onrubia, J., & Engel, A. (2012). The role of teacher assistance on the effects of a macro-script in collaborative writing tasks. *International Journal of Computer Supported Collaborative Learning*, 7, 161-186.
- Overdijk, M., & van Diggelen, W. (2008). Appropriation of a shared workspace: Organizing principles and their application. *Computer-Supported Collaborative Learning*, 3, 165-192.
- Puntambekar, S., Erkens, G., & Hmelo-Silver, C. E. (2011). Introduction. In S. Puntambekar, G. Erkens & C. E. Hmelo-Silver (Eds.), *Analyzing interactions in CSCL* (pp. ix-xiv). New York: Springer.
- Roschelle, J. (1994). Designing for cognitive communication: Epistemic fidelity or mediating collaborative inquiry? *The Arachnet Electronic Journal of Virtual Culture*, 2 (2).
- Schmidt, R. (1990). The role of consciousness in second language learning. *Applied Linguistics*, 11, 192-196.
- Slof, B., Erkens, G., Kirschner, P. A., Janssen, J., & Phielix, C. (2010). Fostering complex learning-task performance through scripting student use of computer supported representational tools. *Computes & Education*, 55, 1707-1720.
- Stull, A. T., & Mayer, R. E. (2007). Learning by doing versus learning by viewing: three experimental comparisons of learner-generated versus author-provided graphic organizers. *Journal of Educational Psychology*, 99, 808-820.
- Suthers, D. D., Girardeau, L. & Hundhausen, C. (2003). Deictic Roles of External Representations in Face-to-face and Online Collaboration. In B. Wasson, S. Ludvigsen & U. Hoppe (Eds.), *Proceedings of the International Conference on CSCL 2003* (pp. 173-182). Dordrecht: Kluwer Academic Publisher.
- Suthers, D. D., & Rosen, D. (2011). A unified framework for multi-level analysis of distributed learning. In B. Alberta (Ed.), *Proceedings of the 1st International Conference on Learning Analytics and Knowledge* (pp.64-74), NY, USA: ACM New York.
- Swain, M. (1985). Communicative competence: Some roles of comprehensible input and comprehensive output in its development. In S. Gass & C. Madden (Eds.), *Input in second language acquisition* (pp. 235-253). Rowley, MA: Newbury House.
- Tuomi, I. (2002). *Networks of innovation: Change and meaning in the age of the Internet*. Oxford, UK: Oxford University Press.
- Warschauer, M. (1997). Computer-mediated collaborative learning: Theory and practice. *The Modern Language Journal*, 81(4), 470-481.
- Wegerif, R., McClaren, B. M., Chamrada, M., Schreuer, O., et al. (2010). Exploring creative thinking in graphically synchronous dialogues. *Computers & Education*, 54, 613-621.
- Wen, Y., Looi, C.K., & Chen, W. (2011). Towards a model for rapid collaborative knowledge improvement in classroom language learning. In H. Spada, G. Stahl, N. Miyake, N. Law, & K. M. Cheng (Eds.), *International Conference on Computer-Supported Collaborative Learning 2011* (pp. 836-851). Hong Kong.
- Williams, J. (2012). The potential role(s) of writing in second language development. *Journal of Second Language Writing*, 21, 321-331.
- Zhu, E. (2006). Interaction and cognitive engagement: An analysis of four asynchronous online discussions. *Instructional Science*, 34, 451-480.

Using Content Analysis to Check Learners' Understanding of Science Concepts

Oliver DAEMS^a, Melanie ERKENS^a, Nils MALZAHN^a & H. Ulrich HOPPE^b

^a*RIAS Institute, Duisburg, Germany*

^b*COLLIDE Research Group, University of Duisburg-Essen, Germany*

*hoppe@collide.info

Abstract: The ongoing EU project JuxtaLearn aims at facilitating the acquisition of science concepts through the creation and sharing of videos on the part of the learners. For the specific learning targets threshold concepts are specified as key elements of knowledge. Content analysis techniques are used to extract learners' concepts manifested in textual artifacts and to contrast these with the anticipated domain concepts (represented as ontology). Deviations between student concepts and the ontology can indicate problems of understanding, which may trigger a revision of the original curriculum. In two studies we explore the potential of (semi-)automated artifact analysis to identify and characterize the students' comprehension problems around knowledge artifacts. In the first study, protocols from a "flipped classroom" style teacher-student workshop are analyzed. The second study analyses comments to videos from educational video platforms. Here, we have applied text analysis methods to identify potential problems of understanding. Also, we have used "signal words" and their relations to domain concepts to highlight potential information needs and problems of understanding.

Keywords: conceptual change, network text analysis, STEM learning, video based learning

1. Introduction

The on-going European project JuxtaLearn aims at fostering learning and curiosity in different fields of science (or STEM) by combining or "juxtaposing" the understanding of domain concepts with performing. Concretely, the students' performance is substantiated in the form of creative video making and editing activities. We see this way of learning by performing and presenting as a variant of Papert's "constructionism" (Papert & Harel, 1991) and as similar to learning by teaching (Gartner, Kohler, & Riessmann, 1971). In this context, we are interested in studying the role of video as a medium for learning in different (including passive) forms of usage.

The design of learning activities in JuxtaLearn is guided by previously identified threshold concepts (Meyer & Land, 2003). Threshold concepts are the basis for reinforcing deeper understanding and further creative production through scaffold reflections focused on essential elements. To identify such concepts and to explore how they are understood and appropriated by teachers and students, a series of face-to-face workshops has been conducted. Following an initial workshop with science teachers, a second workshop also involved a group of six A-level students. The workshop was structured employing a role reversal with students exposing central ideas from the domains as a first step. This enabled the teachers to elicit a deeper understanding of the gaps in the students' knowledge. In our study, this was the first target of applying Learning Analytics techniques to extract structured representations of the underlying conceptual relations.

Since at this point of development the project had not yet produced collections of student-created videos, we have also tried to identify processes of understanding around videos by analyzing existing web-based learning communities, namely from Khan Academy. Since videos from Khan Academy are hosted and therefore also available on YouTube as a less "educationally guided" environment, we were able to compare comments from both contexts. We only analyzed questions and answers, not the videos nor their contents.

We were particularly interested in extracting information from these texts to shed light on the following aspects:

- Associations of concepts (which may be adequate or inadequate from a scientific point of view);

- Concepts that are frequently addressed in questions as indicators of possible origins of problems of understanding;
- Associations between concepts often used in answers as indicators for missing relations in the original understanding

We used these indicators to infer possible misconceptions and “stumbling blocks”. As known from classical learner modeling (Wenger, 1987), we had to distinguish between missing knowledge about concepts and/or relations and misconceptions as often idiosyncratic constructions of incorrect knowledge. An example of a misconception (beyond missing knowledge) would be an in-correct association between two or more concepts.

2. A Network Perspective on Conceptual Models and Conceptual Change

2.1 Application of text mining techniques on learning data

In various scenarios of learning, knowledge building and knowledge production, humans externalize their knowledge in terms of “knowledge artifacts”, which are often represented in the form of texts and thus susceptible to being analyzed by text mining (Heyer, Quasthoff, & Wittig, 2006). Content analysis, as a form of artifact analysis, can be used to reduce qualitative textual data into clusters of conceptual categories aiming to unfold patterns and relationships of meaning (Julien, 2008). Although several (semi-)automated methods can be used to detect these patterns from content, e.g. statistical methods based on the Vector Space Model (VSM) or Latent Dirichlet Allocation (Blei, 2012) as a probabilistic method, these methods are barely used on learning data, so far (He, 2013). Content analysis in the context of learning data has primarily been used for clustering resources, e.g. the grouping of e-learning resources according to their similarity (e.g. Hung, 2012; Tane, Schmitz, & Stumme, 2004). Sherin (2012), however, found that even without using semantic background knowledge, a Vector Space Model (VSM) based clustering of spoken word transcripts is an adequate instrument to identify student’s concepts and the dynamics of their mental constructs. Additionally, He (2013) provided evidence that similar techniques are suitable for grouping learners’ main topics in student-to-teacher online questions and peer-to-peer chat messages related to online video learning lessons.

The aforementioned methods are based on the “bag of word” model, in which the given order of words in a text is of no relevance to the analysis (Blei, 2012). A method that takes the words’ positioning into account is the Network Text Analysis (NTA). NTA is a text mining method, which is based upon the assumption that knowledge can be modeled as a network of concepts (Carley, Columbus, & Landwehr, 2013). Against this background, a concept is a single idea, which is represented by one or more words in a network (nodes). The links representing semantic relationships between these words (edges) are differing in strength, directionality and type based on the words’ position to each other in the text (Carley, Columbus, et al., 2013). The union of all relations builds the semantic network (Carley, Columbus, et al., 2013), similar to the relational network of a concept map. Similar to text networks, concept maps are networks in which knowledge is represented by concepts and their relationships to each other. They differ from text-based semantic networks inasmuch as they are arranged hierarchically with the ontological root concepts at the top (Novak & Cañas, 2008). In the context of knowledge construction research, concept maps are often used to trace the student’s knowledge development (Engelmann & Hesse, 2010; Engelmann, Dehler, Bodemer, & Buder, 2009; Schreiber & Engelmann, 2010).

2.2 Representation of conceptual models as text networks

Jacobsen and Kapur (2010) have suggested to conceive learners’ mental models or “ontologies” as scale-free networks, which would allow to apply known characteristics of such networks to theories of conceptual change. According to Barabási (2009) the evolution of scale-free networks can be explained by the mechanisms of “preferential attachment”. Applied to learners’ ontologies, preferential attachment means that newly learned concepts are most frequently associated or linked to those concepts that are already more densely connected than others. From this, Jacobsen and Kapur (2010) conclude that such “hubs” i.e. nodes with a relatively high degree centrality, represent root categories of knowledge domains. Hoppe, Engler and Weinbrenner (2012) support this theory in a study in which the volunteers had to create concept maps on the subject of global warming. This study clearly showed a scale-free nature of the maps in terms of an inverse power law degree distribution (a known structural characteristic of scale-free networks). This implies that there are more hubs than to be expected in a

randomly connected network. Also, Hoppe et al. (2012) could show that certain known graph-theoretical structural measures correlate with quality judgments of these maps by independent experts. Interestingly, the “density” measure is negatively correlated with the criterion of map “completeness”, which is significant. Again the scale-free model provides a clear explanation: In a growing scale-free network the density is anti-proportional to the size of the network, i.e. the smallest networks will show the highest density. Based on this characterization, the authors hypothesize that newly appearing hubs represent ‘hot spots of conceptual change’ (Hoppe et al., 2012, p 297), whereby this change describes a restructuring process, in which learners revise their false beliefs and misconceptions on the relational or ontological level (Chi, 2008). If the number of edges around a node is suddenly reduced, this may indicate a qualitative change of understanding or a paradigm shift (Hoppe et al., 2012). Viewing concept maps as networks allows for applying a variety of techniques known from Social Network Analysis (SNA - cf. Wasserman & Faust, 1994). As an example, the betweenness centrality measure is suggested as a possible indicator to identify “bridge concepts” that link different knowledge domains (Hoppe et al., 2012). It is important to note that the results of NTA (see above) are also networks that can be further analyzed in the same way as concept maps. This would also allow the comparison of textual input (e.g. from student essays, wikis etc.) with concept maps.

Our basic idea and approach is to use content analysis techniques to generate network representations from knowledge artifacts originally created by students or experts and to apply structural and differential (comparative) measures to these representations in order to detect similarities or mismatches. In this approach, expert maps or ontologies can be used as “normative” references for comparison, e.g. to indicate deviations from standard domain knowledge and possible misconceptions. Regarding the evolution of maps, certain structural features and anomalies can also be detected.

3. Text-based Content Analysis: Method and First Results

3.1 Network Text Analysis

According to Carley and colleagues (2013), the NTA workflow consists of three main steps: (1) data selection and extraction, (2) text pre-processing and (3) network analysis. We have applied this technique using the AutoMap/ORa toolset for NTA (Carley, Columbus, et al., 2013; Carley, Pfeffer, Reminga, Storrack, & Columbus, 2013):

As a first step, the data of interest will be selected, depending on the terms of reference, for instance the selection of comments belonging to a certain person or video. In the second step, the pre-processing functions are intended to prepare the textual data for subsequent analyses. Unneeded and unwanted concepts will be reduced through simple text cleaning functions such as the removal of extra spaces. Furthermore, this step serves to apply a) a stemming for reducing words to their root stem by removing suffixes from words, b) a delete list, which is required for the removal of non-relevant stop words (articles, auxiliary verbs etc.), and c) a manually generated thesaurus, used for replacing synonym concepts with the more standard form, for combining n-grams and to correct spelling errors. Next step of pre-processing is the identification and classification of concepts. Relevant concepts will be detected by analyzing the words’ frequencies based on the following principle: Words and n-grams that appear more than x-times are considered as relevant and will be included into further analyses, whereby x depends on the size of the corpus. The classification is done by the determination of categories based on the words appearing in a concept list that includes the frequency of all words and can be reduced to the most important key words using a threshold defined by the researcher. After specifying the categories, every single concept will be assigned to one of them. Therefore, an ontology-based meta-thesaurus will be created, which later is used for generating the network. As a result of the processes described before, multimodal networks will be created, whereby the modality of the network depends on the number of categories that can be identified by the researcher.

This analysis process has been applied on the transcripts of an initial role reversal workshop surrounding the STEM topics “moles” in chemistry, “potential difference” in physics and “cells” in biology. In each lesson, two students with different school marks (both excellent / mixed / both middle) taught two teachers. The transcripts were analyzed with the method described above.

3.2 First results

As a result of this analysis process, a multimodal network of categorized concepts was generated and visualized using ORa. This network comprises the following concept categories: pedagogical concepts,

domain concepts, general concepts (i.e. concepts that are neither domain specific nor pedagogic concepts), tools, and actors. We have declared actors and domain concepts as the most relevant categories. These categories are represented in a meta-thesaurus. Within this thesaurus, the actor category represents all acting persons in the lessons; teachers have been labeled as T1 to T6, the researcher staff as R1 to R4 and students as S1 to S6. The domain concept category represents discipline-specific topics associated with the lesson subjects.

The number of connections between one actor and surrounding topics (also called “degree”) indicates the thematic richness of an actor’s contributions. Regarding the whole semantic network, the degrees reflect that both physics students (S5 and S6) as well as one of the biology students (S1), who score high in their school marks, have also a higher total degree in the network than the other students with middle school marks. Figure 1 depicts an excerpt of the net, a two-mode network of actors and domain concepts, which contains 16 actor nodes (blue square nodes) and 71 domain concept nodes (pentagonal). The excerpt only shows 6 student actors as well as the connected domain concepts (in blue) and the domain concepts surrounding the connected domain concepts (in grey). Additionally, every subject area and corresponding sub-activity in the workshop (chemistry, biology and physics) forms a cohesive cluster in the overall network, which are possibly interconnected by “bridge concepts”.

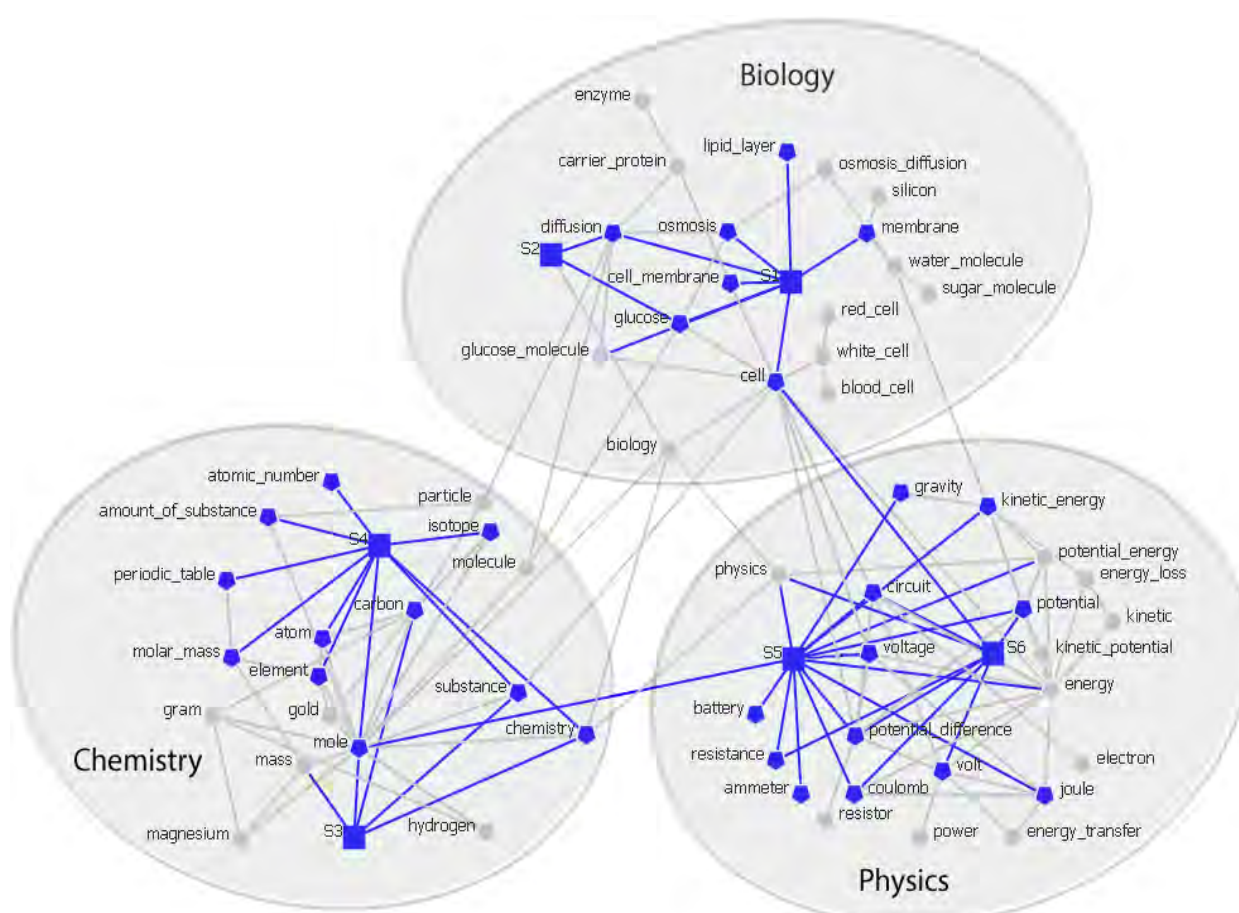

Figure 1. Partial view of a network generated from a teacher-student workshop, depicting connections of students (actors S1-S6) to domain concepts in blue (two-mode network) and relations between domain concepts in grey

Other relevant structural properties of the extracted network are nodes that represent hubs (high in total degree centrality) or nodes that bridge over between other concepts or between areas of discourse, here: the domains (high in betweenness centrality). Figure 2 shows the top six knowledge items ranked according to their total degree centrality and betweenness centrality in the uni-modal domain concept x domain concept network.

Concerning total degree centrality, we could find the three main topics of the workshops “mole”, “potential difference” and “cell” within the top 6 ranking. Furthermore, the nodes high in betweenness centrality seem to bridge over different ontological areas. Mole, for instance, builds a fundamental connection between the physics related cluster and the chemistry related cluster. Furthermore, cell, second highest in betweenness centrality, also connects the three discipline clusters with each other.

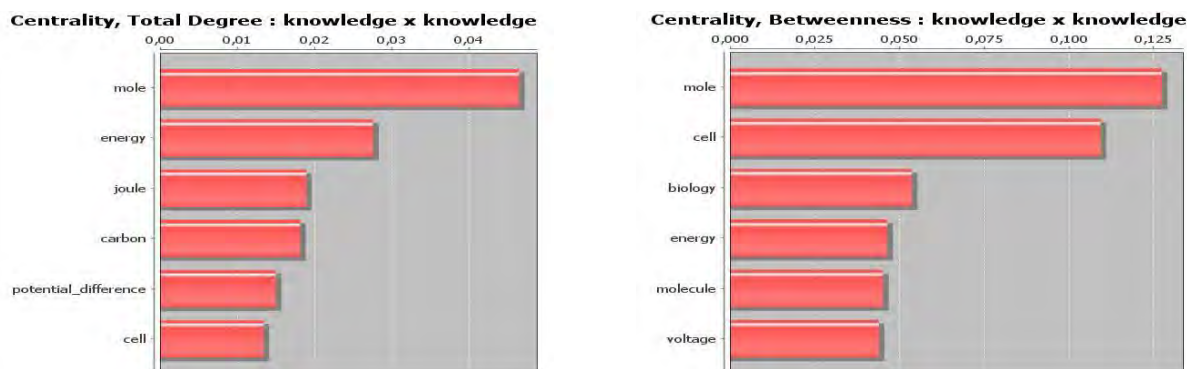

Figure 2. Domain concepts with the highest betweenness centralities (on the right) and highest total degree (on the left) in a domain concept x domain concept network.

Based on this first example, we claim that text networks can not only represent and characterize the specific foci of the JuxtaLearn workshops, but also provide ontological information, which is related to the student’s conceptualization of specific science topics.

Furthermore, NTA seems to be an appropriate method to analyze student generated textual content on the JuxtaLearn online platform to learn more about their conceptual models.

4. Analysis of Video Comments

4.1 Content Analysis

Since the NTA workflow described above was conducted on offline material and suitable data from the online platform was unavailable at this developmental stage of the JuxtaLearn project, we focused on material found outside our project for further research. The approach to content analysis presented here focuses on the attention given to a specific topic in an online discussion around learning materials, which in this case are represented by online discussions composed of comments in discussions around educational videos. This approach aims to extend the NTA workflow by focusing on the content of single comments instead of the complete discussion thread.

We used a quantitative approach implementing regular expressions based matching with the concept lists constructed during the NTA workflow and the preprocessed text base which was generated during this workflow. In principal this generates a sparsely populated feature vector for each comment based on the occurrence frequency of concepts from each list. We use these vectors to construct a measure we call “semantic richness” which tries to quantify the relation between the domain specific concepts and the general concepts occurring in each comment. This measure follows the assumption that a comment that contains more domain concepts than general concepts compared to a different comment which uses a lesser ratio of domain and general concepts is more “on topic” thus semantically richer. During our analysis of external data we derived different methods of evaluating this ratio and the following will present our results.

4.2 Khan Academy and YouTube Videos

As a starting point for our content analysis we have chosen Khan Academy’s learning videos and the accompanying discussion in the comments section. The Khan Academy website provides a significant amount of videos on different STEM topics and offers the option to enter into a learning dialogue with other students, a scenario which is similar to the one envisioned for the JuxtaLearn platform. The website offers message boxes below the videos to enter this dialogue through a scaffolded question/answer construct rather than an open comment section. The videos themselves are hosted on YouTube EDU, which enables users to comment on the same videos without assistive scaffolding. The library covers science topics such as biology, chemistry and physics on different levels ranging from junior high school to university and holds more than 4.300 videos with an average length of 10 minutes (Khan Academy, 2013). For this case study we used three videos with the following titles “The Mole and Avogadro’s Number”, “Diffusion and Osmosis” and “Voltage-Difference between electrical potential (voltage) and electrical potential energy”. In total, we have extracted 1.284 comments through Khan Academy’s web service. These textual artifacts have been used as a sample for our analysis. Khan Academy provides the aforementioned scaffolded discussion elements and encourages discussion on the

topic of the video, which means we can assume that artifacts extracted from the discussion will be about the topic of the video as well. Table 1 gives an overview of the amount of artifacts used in our study. It shows the number of questions and answers for each area the video topic can be assigned to, as well as their sum (# of comments) for easy comparison with other sources.

YouTube EDU is a subsection of YouTube that focuses on educational videos. The idea behind it is to provide everything related to education, spanning from short lessons for supplementing school learning to full courses from universities and other professional material from educators around the globe (YouTube EDU, 2014). As mentioned above, this includes videos from the Khan Academy. For a comparison with the Khan comments, we extracted video comments from YouTube EDU (using the appropriate Google API) for the same three videos. This resulted in another 1.201 comments distributed among the videos as shown in table 2. YouTube EDU does not provide any scaffolding for discussion resulting in a mixture of comments and smaller discussion compared to Khan Academy’s strict question/answer construct.

Table 1: Type and number of extracted comments on STEM videos at Khan Academy’s website.

Type of artifact	Biology	Chemistry	Physics
# questions	184	279	70
# answers	312	362	77
# comments	496	641	147

Table 2: Subject and number of extracted comments on STEM videos from YouTube EDU.

Subject of artifact	Biology	Chemistry	Physics
# comments	487	628	86

4.3 Data Sampling and First Observations

The aforementioned strict construct of questions/answers seems to be enforced by a strong moderation through the Khan Academy staff, because the discussion artifacts have a very low amount of noise (e.g. spam comments). This is reflected by the high amount of very short and poorly written comments extracted from YouTube EDU. Additionally, the artifacts extracted from Khan Academy seem to focus on the video’s topic rather than on the video itself, while the opposite is true for comments from YouTube EDU, which mostly contain short comments that focus on e.g. the quality of the video. This observation can be confirmed by analyzing the content based on the list of domain and other concepts we constructed during the NTA workflow. Employing a quantitative approach we counted the occurrences of general and domain concepts in artifacts from both platforms, representing these values as feature vectors for general and domain concepts. Table 3 shows the results from this approach.

Table 3: Results from statistical computations for the “semantic richness” measure.

Description	Value			
	Khan Academy (N=1284)		YouTube (N=1201)	
Source from which the basis was extracted (N represents the number of comments extracted)	M	SD	M	SD
sum of general and domain concepts (length of comment)	23.73	28.04	9.78	11.03
general concepts: with duplicates only once	9.89 7.62	11.88 7.43	6.07 5.49	6.11 5.12
domain concepts: with duplicates only once	13.84 7.26	17.58 5.60	3.71 2.51	6.27 3.45
1. measure: domain concepts / length	0.54 0.38	0.23 0.20	0.26 0.22	0.26 0.22
2. measure: domain concepts / (general concepts + 1)	1.46 1.08	1.48 1.02	0.50 0.40	0.88 0.63

The two combinatory measures were introduced to create a value describing the semantic richness. We introduced two different formulas for both versions of feature vectors (those using all occurrences therefore with duplicates / those using only the first occurrence), the first normalizes the value to a range of 0-1 but favors shorter comments as a comment containing only one domain concept and no general concepts will have a semantic richness of 1. The second favors longer comments but the value is uncapped, meaning it can grow infinitely when only domain concepts are found (the +1 is needed to avoid division by zero).

The numbers clearly indicate both longer and “semantically richer” artifacts on Khan Academy, which might be a result of the platform’s focus on provision of educational content and discussion or simply the suspected strong moderation.

5. Introducing “Signal Concepts”

5.1 Idea

While scrutinizing the list of most frequent general concepts in an exploratory way, we found a subcategory of words within the comments (such as “help”, “explanation”, “difference_between”) that seem to refer to students' problems of understanding. We decided to select the most frequent of these “signal words” in order to take a closer look at their relationships to adjacent domain concepts in the text network. These signal concepts occur in combination with domain concepts and indicate or “signal” a specific relationship either between the author and a domain concept or between two domain concepts. This distinction is reflected by using two types of signal concepts: unary and binary. Unary signal concepts reference only one domain concept and therefore represent the signal concepts that reference the author and one domain concept, while binary signal concepts reference two domain concepts. An example for a signal concept that defines a relationship between the author and a domain concept is “help_needed”, which may indicate a problem the author has with the connected domain concept, while an example for the latter is “difference_between” that may indicate that the author thinks or inquires about a difference between two domain concepts. Signal concepts provide a resource for teachers interested in learning about potential problems their students might have. Thus, our approach indicates a topic or a domain concept that may be worth focusing on in a future lesson.

Initially we used our NTA workflow to single out signal concepts and visualize this part of the network, Figure 3 shows an example network based on “dont_understand”, “definition” and “difference_between”. This network highlights the inherent problem with analyzing signal concepts through our NTA workflow as there are several connections between the signal concept “difference_between” and different domain concepts without the possibility of identifying their original context. The missing original context means there is no way to identify which of these domain concepts were actually referenced using “difference_between”, since the NTA workflow aggregates all occurrences of a signal concept into a single node. This node has connections to all domain concepts it was attributed to in the complete set of comments analyzed but lacks the original context of each individual comment.

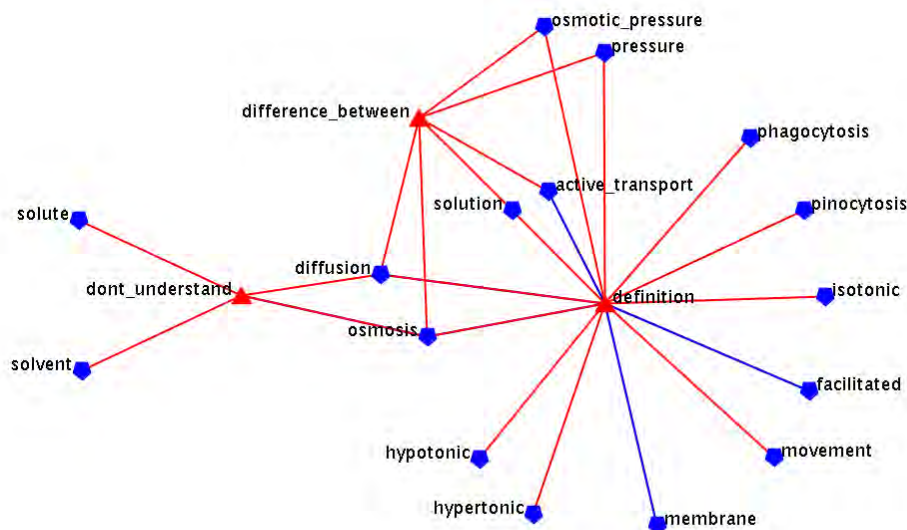

Figure 3. Network showing the neighborhood of “difference_between”.

5.2 Approach

The basic idea behind our refined “signal concept” approach is to be able to correctly identify the original context and avoid the combinatorial blending seen in Figure 3. For this purpose, we generate a new network that is able to visualize the connections between the signal concept and the referenced domain concept(s) separately for each co-occurrence. Here, we did not search for co-occurrences in entire comments but in segments (windows) with a size of seven words in the pre-processed text, i.e. the signal concept and the domain concept(s) can have at most five words between them.

In a further refinement of the method we used a matching algorithm with predefined patterns of domain and signal concepts specified in the form of regular expressions. This algorithm transforms the

preprocessed text into a compact string representation by replacing each word with a single letter symbol. We used six letters (G, D, S, T, M and O) which represent general concepts (G), domain concepts (D), unary signal concepts (S), binary signal concepts (T), binary signal concepts that need to be in the middle of two domain concepts (M) and other (O). The patterns we used for the matching on these string representations are shown in Table 5 and can be broken down into two archetypes, for unary and binary signal concepts. The rules reflect different orders of occurrence in the text for these two types of signal concepts.

Table 5: Patterns used for digging up signal concepts from artifacts.

Pattern	Description
(S)[OG]{0,5}(D)	Matches a unary signal (S) and a domain concept with 0-5 general or other concepts between them.
(D)[OG]{0,5}([MT])[OG]{0,5}(D)	Matches a binary signal concept (T or M) that's in the middle of two domain concepts with 0-5 general or other concepts separating the domain and signal concept.
(T)[OG]{0,5}(D)[OG]{0,5}(D)	Matches a binary signal concept (T) followed by 0-5 general or other concepts, a domain concept, another 0-5 general or other concepts and a second domain concept.

These patterns were then used to highlight the signal and domain concept(s) in their original context as an additional way of visualizing possible problems in a human readable form.

5.3 Results

For the first approach we generated a new network around the signal concept “difference_between” to illustrate the usefulness of our approach and specifically the introduction of the new combination nodes. Figure 4 shows this example network with the node for “difference_between” in the middle surrounded by the combination nodes and the referenced domain concept nodes. The red node represents the signal concept this network focuses on while the purple nodes are the new combination. The size of these combination nodes represent their occurrence in all of the texts we analyzed by being larger the more often the combination of signal concept and both domain concepts occurred. Blue nodes show all the domain concepts that were mentioned along with the signal concept “difference_between” in the data we analyzed.

The second approach resulted in a list of comments with co-occurring signal and domain concept(s), containing highlighting for the referenced concepts. An excerpt of this list is shown in table 6, illustrating the usefulness of this approach. It puts our preprocessed text with highlighting next to the original comment to indicate the detection of a signal and domain concept but also shows the original context both as a means of feedback for us showing the validity of our approach but also as a possible source of information for the teacher in a learning analytics context.

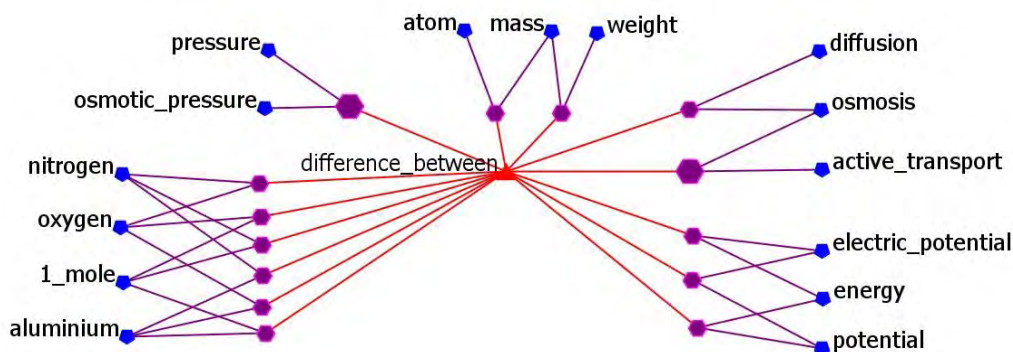

Figure 4. Network including blue combination nodes hovering around “difference_between”.

Table 6: Highlighting of signal and domain concepts next to their original context.

I finally understand osmosis. Thanks Khan!! do_understand osmosis thanks khan
how I know if the membrane will allow sugar to diffuse or not? plzany body reply. explanation i know if membrane be allow sugar diffusion not plzany body reply
KhanAcademy helped me to review a unit on OSMOSIS AND DIFFUSION in my BIOLOGY class! khan_academy help review unit on osmosis_diffusion in biology class
Still confused about osmotic pressure :/ wasted a bit of time.. still confusion about osmotic_pressure / waste bite time
What is the difference between osmosis and active transport definition difference_between osmosis active_transport

6. Conclusion

In our first study, we aimed to find evidence that NTA is a useful instrument to identify and analyze students' conceptual understanding while learning a specific science topic. Similar to a student's self-created concept map, (semi-)automatically generated text networks provide information about the learners' conceptions belonging to the respective discipline. As theoretically expected, we could corroborate that hubs found in the ensuing concept networks indeed represent ontological root categories, e.g. the concept of "mole" that was the main topic of a role reversal lesson and consequently reaches a high value for total degree. Furthermore, given betweenness centrality values support the theory that nodes high in this measure indicate bridges between different ontological areas. Overall, we conclude that the analysis of a network's structural features provides important information on ontology development. This led us to a second study, in which we investigated the impact of differentiating between various categories.

In the JuxtaLearn context, this type of content analysis can serve as a source of diagnostic information regarding the students' understanding and potential misconceptions. Based on our refinement of the NTA approach, we aim to develop a tool for teachers and educational designers that supports them in optimizing the student's learning processes but also revising educational processes and possibly even curricular decisions.

While investigating general concepts of comments in a discussion around publicly available educational videos, we could identify an ontological subcategory of signal words among frequent general terms high in degree. These words (such as "explanation" or "difference_between") indicate a certain type of concepts, which in conjunction with domain concepts can help identify problems of comprehension. Contrary to commonly used content analysis techniques, which are based on a "bag of words" assumption and hence ignore the word's position in a text (e.g. Sherin, 2012), NTA has proven effective in disclosing conceptual relationships of meaning. By means of extending the NTA by a tailored analysis, we receive indicators for drawing conclusions as to which (pre-)knowledge the students might miss or which concepts are particularly difficult to distinguish (such as "osmosis" and "diffusion").

As a next step on our research agenda, we will particularly look at the progression of concept networks over time. Particularly deviations from "normal" progression following the preferential attachment principle (i.e. disappearing hubs or new clusters of high connectivity) will be analyzed to better understand the evolution of the students' conceptual models.

Acknowledgements

This work was partially funded by the European Community's Seventh Framework Program (FP7/2007-2013) under grant agreement 317964 JUXTALEARN.

References

- Barabási, A.-L. (2009). Scale-Free Networks: A Decade and Beyond. *Chroma Technology [UNIV DUISBURG-ESSEN]*, 412–413. doi:10.1126/science.1173299
- Blei, D. M. (2012). Introduction to Probabilistic Topic Models. *Communications of the ACM*, 55(4), 77–84. doi:10.1145/2133806.2133826
- Carley, K. M., Columbus, D., & Landwehr, P. (2013). *AutoMap User's Guide 2013* (Technical Report No. CMU-ISR-13-105) (pp. 1–219). Pittsburgh: Carnegie Mellon University, Institute for Software Research,. Retrieved from www.casos.cs.cmu.edu/publications/papers/CMU-ISR-13-105.pdf
- Carley, K. M., Pfeffer, J., Reminga, J., Storricks, J., & Columbus, D. (2013). *ORA User's Guide 2013* (Technical Report No. CMU-ISR-13-108) (pp. 1–1280). Pittsburgh: Carnegie Mellon University, Institute for Software Research. Retrieved from <http://www.casos.cs.cmu.edu/publications/papers/CMU-ISR-13-108.pdf>
- Chi, M. (2008). Three Types of Conceptual Change: Belief Revision, Mental Model Transformation, and Categorical Shift. In S. Vosniadou (Ed.), *International Handbook of Research on Conceptual Change* (pp. 61–82). New York, Oxon: Routledge.
- Engelmann, T., Dehler, J., Bodemer, D., & Buder, J. (2009). Knowledge awareness in CSCL: A psychological perspective. *Computers in Human Behavior*, 25(4), 949–960.
- Engelmann, T., & Hesse, F. W. (2010). How digital concept maps about the collaborators' knowledge and information influence computer-supported collaborative problem solving. *International Journal of Computer-Supported Collaborative Learning*, 5, 299–319. doi:10.1007/s11412-010-9089-1
- Gartner, A., Kohler, M. ., & Riessmann, F. (1971). *Children teach Children: Learning by teaching*. Dallas, TX, U.S.A.: Harper & Row.
- He, W. (2013). Examining students' online interaction in a live video streaming environment using data mining and text mining. *Computers in Human Behavior*, 29(1), 90–102. doi:10.1016/j.chb.2012.07.020
- Heyer, G., Quasthoff, U., & Wittig, T. (2006). *Text Mining: Wissensrohstoff Text*. Bochum: W3L-Verlag, Herdecke.
- Hoppe, H. U., Engler, J., & Weinbrenner, S. (2012). The Impact of Structural Characteristics of Concept Maps on Automatic Quality Measurement. In J. van Aalst, K. Thompson, M. J. Jacobson, & P. Reimann (Eds.), *The Future of Learning: Proceedings of the 10th International Conference of the Learning Sciences (ICLS 2012)* (pp. 291–298). Sydney, Australia.
- Hung, J. (2012). Trends of E-learning research from 2000 to 2008: Use of text mining and bibliometrics. *British Journal of Educational Technology*, 43(1), 5–16. doi:10.1111/j.1467-8535.2010.01144.x
- Jacobsen, M. J., & Kapur, M. (2010). Ontologies as Scale Free Networks: Implications for Theories of Conceptual Change. In K. Gomez, L. Lyons, & J. Radinsky (Eds.), *Learning in the Disciplines: Proceedings of the 9th International Conference of the Learning Sciences (ICLS 2010)* (pp. 193–194).
- Julien, H. (2008). Content Analysis. In L. M. Given (Ed.), *Qualitative Research Methods* (pp. 120–121). Thousand Oaks, California: SAGE Publications.
- Khan Academy. (2013). A free world-class education for anyone anywhere. *Khan Academy*. Retrieved from <https://www.khanacademy.org/about>
- Meyer, J. H. ., & Land, R. (2003). Threshold concepts and troublesome knowledge: linkages to ways of thinking and practising. In C. Rust (Ed.), *Improving Student Learning - Theory and Practice Ten Years On* (pp. 412–424). Oxford, UK: Oxford Centre for Staff and Learning Development (OCSLD).
- Novak, J. D., & Cañas, A. J. (2008). *The Theory Underlying Concept Maps and How to Construct and Use Them* (Technical Report IHMC CmapTools 2006-01 Rev 01-2008 No. 2). Pensacola: Florida Institute for Human and Machine Cognition. Retrieved from <http://cmap.ihmc.us/Publications/ResearchPapers/TheoryUnderlyingConceptMaps.pdf>.
- Papert, S., & Harel, I. (1991). *Constructionism*. Norwood, NJ: Ablex Publishing Corporation. Retrieved from <http://namodemello.com.br/pdf/tendencias/situatingconstructivism.pdf>
- Schreiber, M., & Engelmann, T. (2010). Knowledge and information awareness for initiating transactive memory system processes of computer-supported ad hoc groups. *Computers in Human Behavior*, 26, 1701–1709. doi:10.1016/j.chb.2010.02.007
- Sherin, B. (2012). Using computational methods to discover student science conceptions in interview data. In *LAK '12 Proceedings of the 2nd International Conference on Learning Analytics and Knowledge* (pp. 188–197). New York: ACM. doi:10.1145/2330601.2330649
- Wasserman, S., & Faust, K. (1994). *Social Network Analysis: Methods and Applications*. New York (USA): Cambridge University Press.
- Wenger, E. (1987). *Artificial Intelligence and Tutoring Systems: Computational and Cognitive Approaches to the Communication of Knowledge*. San Francisco, CA, USA: Morgan Kaufmann Publishers Inc.

Assessment of Developmental Stages of Generic Skills: A Case Study

Katsuko T. NAKAHIRA^{a*}, Makoto WATANABE^a & Muneo KITAJIMA^a

^aNagaoka University of Technology, Jaoan

*katsuko@vos.nagaokaut.ac.jp

Abstract: Generic skills (GS) are meta-competencies necessary for acquiring knowledge from provided information in classes. This paper assumes that GS consists of a skill associated with the literacy for pulling information from the accessible contents in the classes, and a skill associated with the literacy for pushing knowledge stored in the students' brain for obtaining useful information from the instructors. Based on the assumption, we propose a method for assessing developmental stages of GS. Observational studies were conducted in a real classroom for testing this assumption. For preparation, we defined a micro-structure of GS. Using the structure, we identified three critical parameters that should characterise the students' performance on the micro-structure. Then, we selected elite monitors to verify whether micro-structure works in our study. The results suggested that the micro-structure of GS works well in classroom situations. We conclude that three critical parameters are good parameters for assessing developmental stages of GS.

Keywords: Meta cognition, Generic skills, Cognitive Chrono-Ethnography, Human behaviour

1. Introduction

There are a number of versions of the definition for generic skills. However, they commonly suggest that high-order, transferable skills are necessary for almost all complex endeavours. Particularly, the importance of these skills is clearly summarised in "Defining Generic Skills" as follows: "*Generic skills are important because jobs today require flexibility, initiative and the ability to undertake many different tasks. Internationally, there is increasing emphasis being placed on active citizenship and community capacity as reflected in the extensive work on learning communities. Generic skills feature prominently in this body of literature as fundamental to developing successful, progressive communities.* – adapted from *Defining generic skills: at a glance, 2003. 12*” Six common elements listed in "Defining Generic Skills" are as follows: Basic/fundamental skills, People-related skills, Conceptual/thinking skills, Personal skills and attributes, Skills related to the business world, and Skills related to the community.

Under the current state of the society, higher-educational institutions have begun to consider introduction of the skills in their education. In order to handle those skills in the education effectively and efficiently, it would be critical to establish reliable methods for assessing the state of developmental stages of generic skills, or assessing the six elementary skills that support generic skills, in the respective education fields.

A number of methods for assessing generic skills have been proposed. For example, in US, the case for generic skills and performance assessment was introduced by Roger *et al.* (2012). It adopted a batch of multiple-choice and short-answer tests for assessment, which have been the dominant testing regime for generic skills. Another example is Berwyn *et al.* (2003), which proposed assessment methods of generic skills. The assessment is done on the basis of skills and knowledge checklists. The checklist consists of the items such as the things that learners should know, what they should know in order for them to be able to access information, what they are able to do, and the documents that could provide them with evidence of their competence. In this case, learning materials are developed from the checklists, so generic skills are fully mapped to skills and knowledge, and are built-in from the beginning of the training development process. Assessing generic skills includes such activities as completion of workbooks, supervisors' reports, participation in professional networks, and so on.

As for the methods for developing generic skills, there are several propositions, but most of them are based on self-regulating learning. For example, Luca (2002) proposed an instructional design strategy that supports generic skills development, consisting of the following three key learning principles for designing effective learning environments – authenticity, self-regulation, and reflection. The framework was integrated with the ICT technologies. Thus, the pedagogical methods of developing generic skills are growing year by year. Especially, the methods are shifted their focus to integration of ICT technologies probably due to the rapid proliferation of e-Learning.

In this research, we propose a new assessment method for developmental stages of generic skills using trainee’s behaviour by implementing a set of controlled learning task sequences. The assessment is supposed to be applied to educational institutions, so the target is higher-education institutions’ classes. Hence, we focus on the generic skills characterised by the following features: collecting information, organising knowledge, and literacy, related to basic/fundamental skills and conceptual/thinking skills.

2. Methodology

To construct an assessment method, we need to focus on the target of generic skills, conformable to higher educational institution pedagogy. In this case, the place where assessment is done would be classes. Taking into account the constraint imposed on conducting observation at classes, however, we need to select the suitable items of the generic skills. And therefore, we focused on the collective notion of “key competencies”, suggested by Dawe (2002), which represents the important features of the generic skills within all education and training. One of the important key competencies is “collecting, analysing, and organizing information (Council *et al.*, 1992).” This competency includes the following capacities: (1) to locate information, (2) to shift and sort information in order to select what is required and present it in a useful way, and (3) to evaluate both the information itself, and the sources and methods used to obtain it. These three capacities define a basis for assessing developmental stages of generic skills. The results of measurement of these capacities in classes would provide the information where a specific student is located in the spectrum of developmental stages of generic skills.

2.1 Monitoring Students’ Behaviour

In this research, we adopted Cognitive Chrono-Ethnography (CCE). CCE is a methodology for

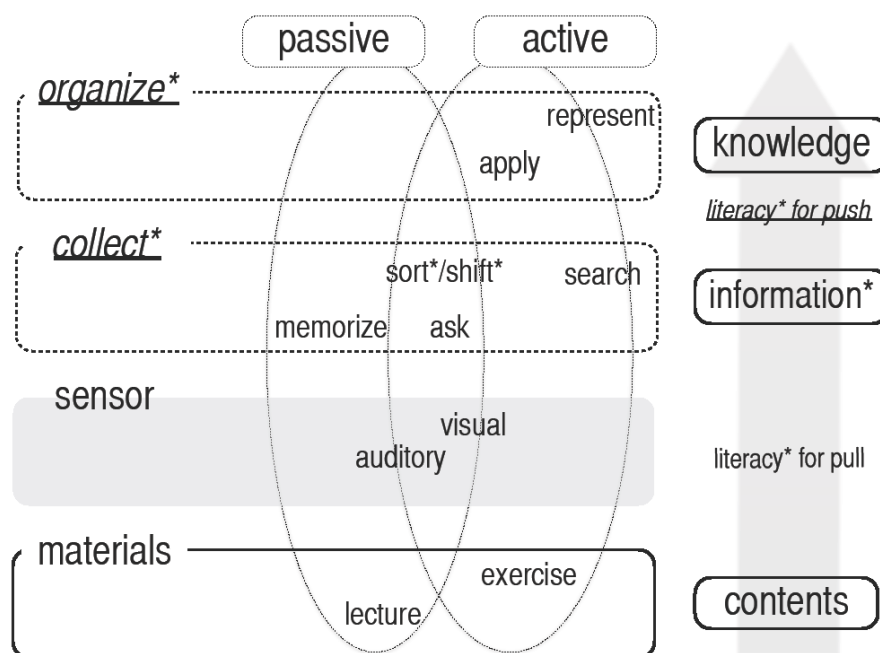

Figure 1. Micro-structure of Generic Skills. *’s are the concepts introduced in Council et al.(1992).

understanding people's daily *in situ* behaviours (Kitajima *et al.*, 2010, Kitajima *et al.*, 2012, Kitajima, 2012), and has been successfully applied to a number of topics to understand people's behavioural changes such as "how some of baseball fans have become aficionados", *etc.* CCE consists of the following six steps; Choose the field of study, Define critical parameters, Recruit elite monitors, *i.e.*, representative subjects in the space defined by the critical parameters, Observe elite monitors' behaviour in the study field, Define a space for representing the observed phenomena, and Analyse the observed behaviour from the viewpoint of the critical parameters. In short, a CCE study would provide detailed descriptions for the representative people's behaviours in the study field, which is characterised by a set of important, or critical, parameters. The students' learning activities in classes would be characterized by a set of parameters, and they would be categorized into a number of activity patterns, each of which is associated with a particular combination of values of the critical parameters.

This paper defines critical parameters that should be associated with generic skills. Each of the critical parameters has values, e.g., high or low. Each student is located at one of the legal points in the parameter space. The students placing at the same point would show similar activities in the classes, providing concrete examples of students' activities with the generic skill level defined by the point in the parameter space.

2.2 Generic Skills

When students attend the class, they try to get some knowledge from the lecture. We assume that generic skills are critical determinant of the way how students organise their activities in the class.

Figure 1 shows the micro-structure of generic skills. It consists of four layers for representing students activities, *i.e.*, materials which the students pay attention to, sensing to convert the physical stimuli on the materials to the perceptual representations, collecting and organising the sensed data for comprehending them as meaningful information, and three layers that correspond to the depths of information processing, *i.e.*, physical contents (data), information (meaning), and knowledge (long-term memory of the students), and three layered framework to generate knowledge from contents material or information. The four layers' elements represent human behaviour; materials, sensor, two activities – collect and organise, which have strong relation to generic skills. The three layers' elements represent the processes of changing materials; contents, information, and knowledge.

Materials : The first layer, *materials*, represents the source where students get information for the subjects instructors are giving in their classes. When instructors make lectures, they construct several professional context and use technical words for explaining them. Sometimes, they make some exercises to give a chance to apply the information or knowledge which students have got through the class. Basically, *materials* are constructed by means of contents which include text, audio talking, figures, and so on, as physical signals or codes. The students pay attention to some materials but not all, depending on their developmental stages of generic skills.

Sense : Human receives these signals through some sensors, such as auditory or visual. The signals are converted to useful information in human brain. Again, the control of sensing, namely which channel to open, is dependent on the developmental stages of generic skills.

Collect : In this process, the brain requires the ability of *literacy for pull*. The collect layer includes some activities, and is divided in two domain modes – passive and active. The passive domain mode has the following features: (1) students get information and memorise it without any comprehension or thinking processes, (2) students ask the instructor for useful information without any deep thinking, and so on. The active domain mode has the following feature: (3) students have a desire to get useful information, and accomplish it by searching literatures by themselves with clear purposes. Each element in this layer is associated with one of the modes exclusively but it is not the case for the sort and shift elements because these elements can operate in either mode depending on the status of students. We assume sort and shift work in the both mode.

Organize : Once the *collect* layer is done, students move to the final layer, *organise*, to convert information to "knowledge". To do this, students make some activities, such as applying the information to several exercise or examples, and integrating the results of application in the form of organised information. Through the process, the mere information changes to knowledge stored in long-term memory, which can be used in the future as needed. In this process, a skill, *literacy for push*, is required. Using this framework, we can make a plan for observing students' generic skills via their behaviours in the real classes.

2.3 Cognitive Chrono-Ethnography

Critical Parameters : Comparing the focused generic skills and Figure 1, we can set reasonable critical parameters. In the figure, human behaviours arise in the processes of collect and organise layer, and *literacy for push*. And therefore, we can identify the following correspondences between them: locate information corresponds with collect process, shift and sort information in order to select what is required and present it in a useful way corresponds with *literacy for push*, and evaluate both the information itself and the sources, and methods used to obtain it corresponds with organise process. Thus, we identify the three items – collect, organise, *literacy for push* – as critical parameters. Then we need to define how to observe these parameters.

Motivation : The motivation of the study is to propose an assessment method of developmental stages of students' generic skill. To do this, we need to construct a model of students' cognitive activity. As shown in Figure 1, we have already done it. Using the frame, we studied it by analysing students' products such as reports or minutes note which summarise the contents of the lecture they attend and make comments or academic questions to the instructor. There are several ways for the analysis. This paper reports the first analysis has done for an exercise style class to which a small number of students attend, considering whether our frame is good for describing students' behaviour in the class or not.

Elite Monitors : In this practice, we chose an exercise style class to which attended nine second grader from the undergraduate course of the university. Each student knew how to search information using the search engines in the web, but they were poor at or did not know how to draw graphs. We used a consecutive 3 classes which took 135 minutes per class. The instructor set three themes for a statistical graph drawing exercise with a spreadsheet application whose difficulty levels were set to low, middle, and high. Through the exercise, the instructors did not provide any textbook or documents. If they wanted to finish the exercise and did not have the necessary skills for drawing graphs, they needed to search the available sources of information for ICT literacy for using the spreadsheet application, knowledge for handling data statistically, or raw data to do the exercise. In this situation, if students' generic skills were high and good for literacy for both push and pull, students would show active domain mode behaviour.

Our goal is to identify students' conditions whether they can acquire knowledge from the contents that were given to them or were found by their efforts. Table 1 shows the relationships between the students ability and what they finally acquired from the contents through a series of conversion processes. Although we tend to assume intuitively that students can always organise knowledge from clear and good information, there are complex processing steps that are necessary for converting such information to well-organised knowledge. Even if a student has high ability for collecting and organising information, he/she would not be able to construct knowledge from the information without high *literacy for push*. Or, if a student has low ability for collecting and/or organising information, he/she would not be able to give appropriate representation for the information unless enough time is available. This table shows the conditions of the states of students for characterising various manifestations of generic skills, including elapsed times, quality of products, activity logs which they check webpage, and so on.

Through this consideration, we set some critical parameters to evaluate students' generic skills; – activities for collecting information and organising knowledge, and *literacy for push*. To observe these critical parameters, we gathered students' behavioural data.

Observation : After preparation, we started to observe students' behaviour, in this case, "observe students' behaviour" means gathering students' behavioural data. We set the gathering data from students as: (1) searching activity logs which include the elapsed times per 15 minutes and the URLs students visited, and (2) products which students draw graphs with finished time. With the parameters and frame, we consider some important relationships -- *short elapsed time to solve exercise* and *long elapsed time to solve exercise*. After these considerations, we set three critical parameters for collecting, organizing, literacy. For literacy, we can assess just *literacy for push* because the ability of *literacy for pull* is the activity in human brain so we cannot check unless represented with language. We observed students' activities using these critical parameters. Through these observations, we found good

Table 1. the relation of students' behaviour and layers for constructing knowledge. The codes in table header are: "A" means active mode, "P" means passive mode, "AT" means human attitude for collecting/organizing information, "F" means the final reception form of contents. The codes in each cells are: "H" means high ability, "L" means low ability, ● means high level of knowledge, ○ means low level of knowledge, and ■ means just contents.

Collect	H								L								
Organize	H				L				H				L				
Literacy For pull	H	L	H	L	H	L	H	L	H	L	H	L	H	L	H	L	
Literacy For push	H	L	H	L	H	L	H	L	H	L	H	L	H	L	H	L	
AT	A	P	A	N/A	A	P	A	N/A	A	P	A	N/A	A	P	A	N/A	
F	● information								○ information								■

relationships between these critical parameters, and found several patterns of students' types. Through these verifications, we conclude the three critical parameters are useful for generic skill assessment.

3. Apply The Method of Generic Skill Assessment For Mass Students

After showing the validity of the critical parameters, we would like to apply the method of generic skill assessment for mass class students. In this case, we cannot obtain detailed students' active logs. In place of active logs, we used "minutes notes", which are generated by students at the end of five to ten minutes in each class. The note consists of two questionnaire: (1) please write new knowledge you have got in this class, (2) please make comments or questions for this class.

We applied this assessment method to a lecture to which attended up to 60 graduate students of the university. From the registered students of the class, we selected 28 students, who attended 10 to 12 classes. The following pieces of information are included in the minutes note: (1) technical term(s) which were used in the class, (2) question(s) which students had, (3) narrative impressions which students felt. We extracted the values of the critical parameters as follows:

for collecting : We counted the number of technical terms in the first question of the minutes notes. When students got new technical terms in the class, we assume they felt the word conveying important information. It is regarded as just "collect" information.

for organizing : After collecting new technical terms in the class but just "collecting", technical terms keep "information" status. They are not converted information to knowledge unless being "organised".

for literacy : We counted the number of nouns, verbs, and adjectives for the first question in the minutes notes to observe students' literacy. Writing process of minutes note, the students had to use their ability of literacy. Here, we focus on *literacy for push*. Though the students got good information or not in the class, they represented their thinking or new information with terms, such as verbs, nouns, and so on. If students' had rich vocabulary, they would have ability to represent their thinking by selecting appropriate words in their vocabularies.

Figure 2 shows a part of results of the generic skill assessment. Results of assessment are represented by numerical conversion, so we can make visualisation for these results.

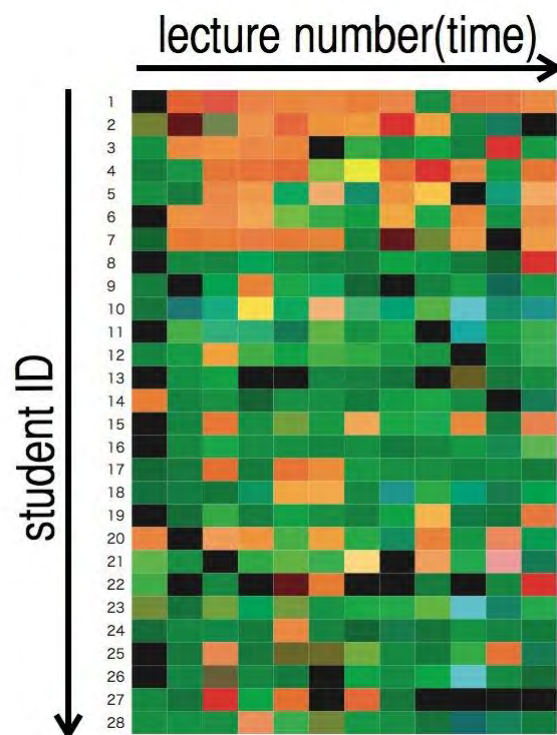

Figure 2. Generic skill assessment applied to 28 student attended classes.

Here, we assigned RGB colour for each critical parameter: blue colour is assigned to collecting information, green colour is assigned to literacy, and red colour is assigned to organisation. The upper group of student IDs in the figure show the red end of the spectrum. It means they might have rich organization generic skills; the ability of converting information to knowledge. The middle ones show the blue/green end of the spectrum. It means they might have rich collecting generic skills or just represent several impressions; the ability of collecting information and *literacy for pull*. From the left side to right side of the figure shows the elapsed time. Most students have not changed their ability – represented almost in the same colour – but several students such as students ID 10 transformed their ability – changing their colour spectrum –. Thus, we conclude the method of generic skills assessment seems to work well.

4. Conclusion

In this paper, we proposed an assessment method for partly generic skills in higher-educational class. The feature of the method is that it is based on “observing” students’ activity, and the results of observation is easily quantified by means of visualisation and assessment process is facilitated. For constructing the method, we used the CCE methodology for understanding people’s daily in situ behaviours. Most important point of the proposed assessment method is that it defines the critical parameters – collect, organise, and *literacy for push*. Through interpreting the critical parameters, we implemented an observational method for collecting students’ information that is related with the parameters. After defining critical parameters, we assessed the method for its effectiveness for the students who attended the university class. Tracking the students’ behaviours, we conclude the assessment method is effective. We think one of the supports is to understand students’ study style whether they do just collecting new information, tend to organise knowledge which is collected in class, or other type. If we identify the student’s study style properly, we can customise the e- Learning contents sequence in such a way that they are fully optimised to the skills of each student.

Acknowledgements

The study described in this paper has been partially funded by the Scientific Research Expense Foundation C Representative: Kumiko Aoki (24531274).

References

- Berwyn, C., Kaaren, B., David, M., and Andrea, B. (2003). Assessing and Certifying Generic Skills. *NCVER Ltd.*. Council., A. E., Mayer, E., Council., A. E., Ministers for Vocational Education, E., (Australia), T. (1992). Key competencies : report of the Committee to advise the Australian Education Council and Ministers of Vocational Education, Employment and Training on employment-related key competencies for postcompulsory education and training. *Australian Education Council and Ministers of Vocational Educational Education, Employment and Training*.
- Dawe, S.(2002). Focussing on Generic Skills in Training Packages. *NCVER Ltd.*.
- Kitajima, M. (2012). Cognitive Chrono-Ethnography (CCE): a methodology for anticipating future user needs. *In Work: A Journal of Prevention, Assessment and Rehabilitation*, 41, 5251–5258.
- Kitajima, M., Nakajima, M., and Toyota, M. (2010). Cognitive Chrono-Ethnography: A method for studying behavioral selections in daily activities. *In Proceedings of the Human Factors and Ergonomics Society 54th Annual Meeting, Human Factors and Ergonomics Society*(pp. 1732-1736). Santa Monica, CA.
- Kitajima, M., Tahira, H., Takahashi, S., and Midorikawa, T. (2012). Understanding tourist’s in situ behavior: a Cognitive Chrono-Ethnography study of visitors to a hot spring resort. *Journal of Quality Assurance in Hospitality and Tourism*, 12, 247–270.
- Luca, J. (2002). Developing an instructional design strategy to support generic skills development. *In Eds.), Proceedings of ASCILITE 2002: Winds of change in a Sea of Learning: Charting the course of digital education*, (pp 401-411) UNITEC Institute of Technology.

‘Does it Make Sense’ or ‘What Does it Mean’?

Jon MASON

School of Education, Charles Darwin University, Australia

jon.mason@cdu.edu.au

Abstract: This conceptual paper problematizes a distinction between *meaning-making* and *sense-making* as activities that support learning. In framing this distinction, various theoretical perspectives on sense-making are introduced from a range of disciplines that have direct implication for the ongoing development of the digital environment designed specifically to support learning. The digital environment is replete with choices that enable communication, information-seeking, knowledge sharing, computation, and learning – all made possible by a diversity of technologies. Semantics have a significant computational role in this environment and making sense of it, amidst constantly emerging capabilities, represents opportunities for innovation as well as challenges for digital learning. While meaning-making has a pivotal role in knowledge construction in this environment it is argued that sense-making often precedes it, thereby indicating a specific role for *sense-making technologies*.

Keywords: sense-making, sensemaking, meaning, semantics, sense-making technologies

1. Introduction

Human beings have been making sense of things for a very long time – no doubt, long before language was invented. While the milieu might be vastly different, making sense of things is as routinized today within digital learning contexts as it likely was in the Stone Age. It is a conscious human act that supports meaning-making, learning, and the development of understanding and reasoning skills – whether as a young child interacting with the world they have been born into or as a researcher immersed in analysis of disparate datasets and the received wisdom of relevant theory.

Despite its historical roots the term *sense-making* (also *sensemaking*) appears to have only entered academic discourse in recent times, finding traction as a construct across a broad range of disciplines. Some researchers trace its recent roots to the work of Bush (1945) in his visioning of the “Memex” (Chi and Card, 1999, p. 18). More explicitly, from the field of communications and information science, Dervin (1983; 1998; 2003) has described it as “a mandate of the human condition” (2005, p. 27); in human-computer interaction (HCI) Russell, Stefik, Pirolli, and Card (1993) define it as “the process of searching for a representation and encoding data in that representation to answer task specific questions” (p. 269), while in the context of intelligent systems development “the basic sensemaking act is [described as the] data-frame symbiosis” (Klein, Moon, and Hoffman, 2006, p. 88); in organizational development, Weick (1993) describes it as “structur[ing] the unknown ... grounded in both individual and social activity” (pp. 4-6); and, in knowledge management, Snowden (2002) presents it in terms of a framework or model for dealing with complexity. It is also a term that has begun to appear in mainstream e-learning discourse such as *The Horizon Report* (Johnson *et al.*, 2010, p. 3).

This paper draws upon all these perspectives while problematizing a distinction between *sense-making* and *meaning-making* for the following reasons. Firstly, it is often the semantic dimension of digital innovation (the Semantic Web and *semantic technologies* generally) that has captured the imagination of those visioning the next iteration of the digital revolution (Hendler, 2009). Secondly, it is arguable that “(t)he concept of meaning is every bit as problematic as the concept of mind” (Tiles, 1987, pp. 450-454). Thirdly, from a pedagogical perspective, constructivist theory highlights the role of meaning-making in the construction of knowledge but says little about sense-making. It is argued here that while sense-making is important in knowledge construction it does not necessarily invoke meaning-making and is an activity that has a prominent role in human-computer interaction.

2. Distinguishing Key Terms

A practical rationale for why this distinction is made is that making sense of things has utility as a turn of phrase (just as common sense has) while finding meaning in something is somewhat more problematic and can raise issues of subjective semantics and philosophy (such as vexed questions concerning the meaning of life). In many contexts *sense-making* and *meaning-making* are interchangeable. For example, in understanding how to respond when driving a car and approaching a red light: making sense of this situation and understanding the meaning of a red light are one and the same. In situations involving more complexity, such as understanding statutory legislation concerning carbon pricing, making sense of documentation may require reasoning, reflection, and analysis while the meaning of such a document might simply be understood as a mechanism to ameliorate climate change. Such meaning could be inferred prior to making sense of the documentation or after having done so but is not necessarily ascribed in the process/es of sense-making or essential to it.

2.1 Information and meaning

“we live in a universe where there is more and more information and less and less meaning” (Baudrillard, 1988, p. 95). Such an observation raises questions concerning the contemporary situation, such as whether web technologies ameliorate or exacerbate this. It also suggests that with less meaning-making perhaps there may be a clearer appreciation for the role of sense-making.

A key feature of information is that it can be described in terms of its semantic properties – for example, its context, subject matter, and provenance. Describing information this way is an essential practice for librarians when they catalogue it according to various classification schemes, the core of which can be reduced to generic semantics of *who*, *what*, *when*, and *where*. This core set of semantics has been described as the “primitives of information retrieval” (Mason, 2012) as they constitute the basis of most metadata schemas. The information contained within such metadata schemas is also largely factoid in nature and not subject to interpretation (Verberne, 2010) – and therefore, any associated meaning is not contestable. In learning contexts, however, content contains more than information – such as data, declarative knowledge, procedural knowledge, rich media, argumentation, and explanation. It is these dimensions of content that require both sense-making and meaning-making for learning to proceed (Mason, 2014; 2012; Mooney, 2011).

2.2 Linguistic perspectives

Linguistic perspectives also assist in making this distinction. As activities, both meaning-making and sense-making are verbs; however, the former is also primarily associated with the semantics of content, which is typically describable in terms of nouns and properties, or as propositions (as in the Resource Description Framework). As such, it is indicative of an end result or outcome – a naming, or “*nouning*”. In contrast, Dervin’s (1999) articulation of her “Sense-Making Methodology” gives particular emphasis to the role of “verbing” and “Sense-Making is described as a verbing methodology ... a methodology for communication practice” (pp. 731-736). Dervin (1998) also explains that her “approach to studying human sense making ... has from its inception conceptualized knowledge and information as a verb” (p. 36). Dervin’s later work also carries this strong emphasis where “Leadership 2.0” is described in terms of “knowledging” (Cheuk and Dervin, 2011).

2.3 Constructivism and meaning

As a term within educational contexts, such as constructivist discourse and “meaning-centered education” *meaning-making* is a pivotal construct (Kovbasyuk and Blessinger, 2013; Whiteside, 2007; Jones and Brader-Araje, 2002; Hein, 1999; Jonassen et al., 1999; Jonassen et al., 1995; Driver and Oldham, 1986). While there is variation in emphasis within the constructivist literature there is evidence to suggest that meaning-making and constructivism are terms that have sometimes been conflated:

Is meaning making constructivism? Is constructivism meaning making? Short answers to these two questions are ‘No’ and ‘Yes’, respectively. The two terms, although frequently confused, are not synonymous ... All discussions of constructivism include meaning making; but

meaning making (although often appropriately called ‘knowledge construction’) does not necessarily imply constructivism. (Hein, 1999, p. 15)

What is arguably most important within constructivist theory, however, is the independent (though socially-situated) construction of knowledge – and both meaning-making and sense-making can be seen as contributing to this. The issue here is not whether the discernment or inference of meaning plays a major role in knowledge construction; it is whether it is intrinsic to it. Discernment or inference of meaning can be understood as sense-making activities but they do not define the scope of sense-making. The following discussion probes this distinction further.

2.4 Human-Computer Interaction and sense-making

Sensemaking has been a key consideration of Human-Computer Interaction (HCI) for over two decades (Russell, et al., 1993). HCI is a field of study that addresses diverse elements of interface design, semiotics, semantics of messaging, dialogic cues, usability and user control, media specifications, layout, navigation, and consistency, etc (Russell, et al., 2008; Russell, et al., 1993; De Souza, 2005; Rogers, Sharp, and Preece, 2011). Sensemaking in HCI spans all these topics as well as being a concern in its own right because it is a topic concerned with how the user can optimally interact with a computer and to achieve this the user needs to make sense of the interface as well as the content.

Recent HCI literature reveals a growing interest in sensemaking (Pirolli and Russell, 2011; Faisal, Simon, and Blandford, 2009; Paul and Morris, 2009; Klein, Moon, and Hoffman, 2006). Even so, it would appear that in a similar way that meaning-making and constructivism sometimes get conflated so does meaning-making and sensemaking in HCI. In paraphrasing Weick (1995) and Pirolli and Card (2005) Faisal et al. (2009) write that in broad terms “Sensemaking ... is the process of *finding meaning from information*. As such, it is intrinsically linked with *information seeking* as both an outcome and a driver.” (p.1) [emphasis added] Such a generalization may indeed be true for many situations that demand the parsing of information, but it also masks the underlying complexity and diversity of sense-making in which activities focused on gaining understanding do not necessarily produce meaning. A simple example is in processing the reasoning of an explanation. Nonetheless, Faisal et al. (2009, pp. 2-6) have proposed a practical (non-exhaustive) classification and “design methodology” of the variety of representations of sense-making used in HCI:

- Spatial – depicting objects and their spatial relationships
- Argumentational – representing proposition(s) and the logical operations that might link them
- Faceted – properties of an entity or entities within a domain
- Hierarchical – showing asymmetrical, one-to-many relationships
- Sequential – depicting a time series or chronology
- Network – depicting arbitrary, many-to-many relationships

From this scheme it can be seen that representations used in HCI sense-making involve a range of abstractions; however, at least two commonplace sense-making representations are missing from this list: firstly, symbols used in signs; and secondly, linguistic representations (textual or ideographic) in which semantics, syntax, morphology, and grammar all play important roles. It is also arguably the case that design innovations such as *infographics* also belong in this list as a *hybrid* or *aggregate* type.

2.5 Intelligent Systems and sense-making

Some concerns of HCI are shared by artificial intelligence (AI) – a field often referred to in recent years as *intelligent systems*. The application of AI within digital learning has typically been in the form of intelligent tutoring systems, although elements of intelligence can be seen in many common web and office software applications (such as suggested search terms or word corrections) and embedded into the design of the smart phone. It is within AI that the construct of the *frame* has been used for over four decades as a data structure that represents a viewpoint or set of assumptions (Minsky, 1974). The capability of representing everyday *common sense* as a manifestation of intelligence has been a fundamental problem for the AI community to solve from its beginnings. This problem of representing common sense continues today despite significant advances in the understanding and representation of context for any iteration of common sense representation (Lieberman and Havasi, 2012).

Of specific relevance to this paper is the presence of the frame as a pivotal construct within the “Data/Frame theory of sense-making” proposed by Klein, Moon, and Hoffman (2006b), in which it is the relationship between these two entities that matters most: “A frame functions as a hypothesis about the connections among data” (p. 88). In this theory, sense-making is presented as a cyclical process that *can* (though not necessarily *must*) involve assimilation, elaboration, questioning, doubting, and reframing. At various moments a hypothesis becomes plausible and this plausibility builds understanding. But is it the *meaning* of the hypothesis or its *reasonableness* that is preeminent when something becomes plausible? While it is the case that a frame(work) will likely have semantic content, sense-making is an activity conceived here as recognizing and postulating connections or relationships between data and frame and has an impact upon conceptualization and re-conceptualization. To characterize this process, or its goals, only in terms of meaning-making seems to diminish not only the process of sense-making but cognition itself.

2.6 *Connectivism*

The work of Klein, Moon, and Hoffman (2006a) has also found resonance for Siemens (2012) in his elaborations of his theory of connectivism since its first articulation (Siemens, 2004). It is not hard to see why: Klein, et al., suggest that “Sensemaking is a motivated, continuous effort to understand connections (which can be among people, places, and events) in order to anticipate their trajectories and act effectively” (Klein, Moon, and Hoffman, 2006a, p.71).

Siemens (2004) has proposed “connectivism” as a “learning theory for the digital age” in which technology networks are conceived as enabling new and rich connections to a diversity of entities all linked to continual learning and activities in which “the pipe is more important than the content within the pipe”. The distinguishing characteristic of Siemens’ theory is the prominent role of networks in creating connections between disparate learning sources and events (Siemens, 2005). Siemens’ central insight regarding the role of networks is consistent with the sociological work of Castells (1996, 2001) in outlining the “rise of the network society” and in the work of Benkler (2006) on the “social production of intellectual capital”. In some respects it also represents a re-articulation of connectionist theory grounded in mathematics that was first developed by Thorndike (1932) and later in the field of artificial intelligence (Pinker and Mehler, 1988). In presenting a recent, concise summary of connectivism, Downes (2014) states: “According to connectivism, learning is the formation of connections in a network.” In the context of this paper, there is some alignment between connectivist (and connectionist) perspectives and sense-making although there are differences in conceptualization.

In the initial articulation of connectivism Siemens (2004) connects “meaning making” with learning but does not use the term sensemaking until some years later. But while the term “sensemaking” has found its way into the later discourse on connectivism (Siemens, 2012; Downes, 2011) it would appear that it is still very closely aligned with meaning-making: “Meaning-making is the foundation of action and reformation of viewpoints, perspectives, and opinions” (Siemens, 2006).

In recent work Siemens (2012) suggests “Sensemaking, then, is essentially the creation of an architecture of concept relatedness, such as placing ‘items into frameworks’.” This shows some similarity with the Data/Frame theory of Klein et al., but the definitive character of this statement can be seen as counter to Dervin’s (1999) “verbing” perspective which gives emphasis to process rather than outcome. There is, however, a more important distinction to be made in terms of how “sensemaking” is used in connectivism and Dervin’s work. For Dervin (1999), Sense-Making Methodology represents a research tool that is not aligned with any particular learning theory and is instead conceived as a “metatheory”. In terms of this paper Siemens’ representation of sensemaking primarily as “concept relatedness” also privileges the semantic domain and is not as richly presented as in the HCI discourse where mental representations are not necessarily in the form of concepts (such as scripts, models, and symbols).

Despite the differences in conceptualization, however, connectivism represents a plausible theory of how learning proceeds in some contexts – that is not being contested here. Its emphasis upon connections and connecting can also be seen as consistent with sense-making activities despite its limited depiction of sensemaking. As Downes (2014) argues “A connectivist account ... look[s] well beyond rules and meaning.”

3. Conclusion

This paper has been explicitly theoretical in addressing the distinction between sense-making and meaning-making. In determining the complexity of relationships between these two constructs it has been instructive to consider that semantic content represents just one of the functional components of natural language. Communicating in natural language would not be complete – or make much *sense* – without syntax, morphology, phonology, pragmatics, and grammar.

In very general terms the semantics of meaning-making suggest the formation of concepts and conceptual relationships. The semantics of sense-making suggests connection, causation, process, analysis, and probing. In learning, both activities are complementary. Yet it is also the case that both activities can function independently. This distinction suggests scope for developing technologies specific to supporting sense-making – as such, they might be identified as *sense-making technologies*.

References

- Baudrillard, J. (1988). *In the shadow of the silent majorities or the end of the social*, (trans. P. Foss, P. Patton & J. Johnson). New York, NY: Senro text.
- Benkler, Y. (2006). *The Wealth of Networks: How Social Production Transforms Markets and Freedom*. New Haven: Yale University Press.
- Bush, V. (1945). As we may think. *Atlantic Monthly*, 176(1), 101-108.
- Castells, M. (1996). *The Rise of the Network Society – The Information Age: Economy, Society and Culture. Vol. I*. Oxford UK: Blackwell.
- Cheuk, B. & Dervin, B. (2011). Leadership 2.0 in Action: a Journey from Knowledge Management to "Knowledgeing". *Knowledge Management & E-Learning: An International Journal*, 3 (2), 119-137.
- Chi, E. H., & Card, S. K. (1999). Sensemaking of evolving web sites using visualization spreadsheets. In *Info Vis '99 Proceedings, IEEE Symposium on Information Visualization* (pp. 18-25). IEEE
- De Souza, C. S. (2005). *The semiotic engineering of human-computer interaction*. Boston, MA: MIT Press.
- Dervin, B., Clark, K., Coco, A., Foreman-Wernet, L., Rajendram, C., & Reinhard, C. (2011). Sense-Making as Methodology for Spirituality Theory, Praxis, Pedagogy, and Research. Presented at the *First Global Conference on Spirituality in the 21st Century*, Prague, Czech Republic. Retrieved from <http://www.inter-disciplinary.net/wp-content/uploads/2011/02/Dervin-paper1.pdf>
- Dervin, B. (2003). Given a context by any other name: Methodological tools for taming the unruly beast. In B. Dervin, L. Foreman-Wernet, & E. Lauterbach (Eds.), *Sense-making methodology reader: Selected writings of Brenda Dervin* (pp. 111–132). Cresskill, NJ: Hampton Press.
- Dervin, B. (1999). On studying information seeking methodologically: the implications of connecting metatheory to method. *Information Processing and Management* 35, 727-750.
- Dervin, B. (1998). Sense-Making Theory and Practice: An Overview of User Interests in Knowledge Seeking and Use. *Journal of Knowledge Management* 2(2), 36-46.
- Dervin, B. (1983). An overview of Sense making: concepts, methods, results. International Communication Association annual meeting, Dallas, TX.
- Downes, S. (2014). Connectivism as Learning Theory. *Half an Hour (Personal Blog)*. Retrieved from <http://halfanhour.blogspot.com.au/2014/04/connectivism-as-learning-theory.html>
- Downes, S. (2011). *Sensemaking artifacts*. Stephen's Web. Retrieved from <http://www.downes.ca/post/56831>
- Driver, R., & Oldham, V. (1986). A constructivist approach to curriculum development in science. *Studies in Science Education*, 13(1), 105-122. DOI: 10.1080/03057268608559933
- Duffy, M. (1995). Sensemaking: A Collaborative Inquiry Approach to "Doing" Learning. The Qualitative Report. Retrieved from <http://www.nova.edu/ssss/QR/QR2-2/duffy.html>
- Faisal, S., Attfield, S., & Blandford, A. (2009). A Classification of Sensemaking Representations (pp. 1–6). *Presented at the CHI 2009 Workshop on Sensemaking*, Boston, MA. Retrieved from <http://discovery.ucl.ac.uk/14803/1/14803.pdf>
- Fisher, J., Norris, S., & E. Buie (2012). Sense-making in Cross-channel Design. *Journal of Information Architecture*, 4(1-2). Retrieved from <http://journalofia.org/volume4/issue2/02-fisher/>
- Forester, J. (1985). Designing: Making sense together in practical conversations. *Journal of Architectural Education*, 38(3), 14-20.
- Hein, G. (1999). Is meaning making constructivism? Is constructivism meaning making? *The Exhibitionist*, 18(2), 15-18.
- Hendler, J. (2009). Web 3.0 Emerging. *Computer*, 0018-9162/09, 88-90.
- Jahnke, M. (2013). *Meaning in the Making – Introducing a Hermeneutic Perspective on the Contribution of Design Practice to Innovation*. Doctoral Thesis, HDK – School of Design and Crafts, Faculty of Fine,

- Applied and Performing Arts, University of Gothenburg. Retrieved from <https://gupea.ub.gu.se/handle/2077/33428>
- Jonassen, D., Davidson, M., Collins, M., Campbell, J., & Haag, B. (1995). Constructivism and computer-mediated communication in distance education. *American journal of distance education*, 9(2), 7-26.
- Jonassen, D. H., Peck, K. L., & Wilson, B. G. (1999). *Learning to Solve Problems with Technology: A Constructivist Perspective* (2nd Edition). Columbus, OH: Prentice Hall.
- Johnson, L., Levine, A., Smith, R., & Stone, S. (2010). *The 2010 Horizon Report*. Austin, Texas: The New Media Consortium.
- Jones, M. G., & Brader-Araje, L. (2002). The impact of constructivism on education: Language, discourse, and meaning. *American Communication Journal*, 5(3), 1-10.
- Klein, G., Moon, B., & Hoffman, R. (2006). Making Sense of Sensemaking 2: A Macrocognitive Model. *IEEE Intelligent Systems*, 21(5), 87-92.
- Kovbasyuk, O., & Blessinger, P. (Eds.). (2013). *Meaning-centered Education: International Perspectives and Explorations in Higher Education*. New York, NY: Routledge.
- Lieberman, H., & Havasi, C. (2012). Introduction to Special Issue on Common Sense for Interactive Systems. *ACM Transactions on Interactive Intelligent Systems*, 2(3). DOI: 10.1145/2362394.2362396
- Mason, J. (2014). Theorizing *Why* in Digital Learning: Opening Frontiers for Inquiry and Innovation with Technology. In D. G. Sampson et al. (eds.), *Digital Systems for Open Access to Formal and Informal Learning*, DOI: 10.1007/978-3-319-02264-2_8
- Mason, J. (2012). Scaffolding Reflective Inquiry – Enabling *Why*-Questioning while e-Learning. *Research and Practice in Technology Enhanced Learning* 7(3) pp.175-198.
- Minsky, M. (1974). A Framework for Representing Knowledge. MIT-AI Laboratory Memo 306, June, 1974. Reprinted in P. Winston (Ed.), *The Psychology of Computer Vision*. McGraw-Hill.
- Mooney, B. (2011). Know-that, know-how and know-why: the unity of knowledge. In T. B. Mooney & M. Nowacki (Eds.), *Understanding Teaching and Learning*, pp. 66-69, St Andrews Studies in Philosophy and Public Affairs, Exeter: Imprint Academic.
- Paul, S., & Morris, M. (2009). Understanding and Supporting Sensemaking in Collaborative Web Search (pp. 1-6). *Presented at the CHI 2009 Workshop on Sensemaking*, Boston, MA.
- Pinker, S., & Mehler, J. (1988). *Connections and Symbols*. Cambridge MA: MIT Press.
- Pirolli, P., & Russell, D. (2011). Introduction to this Special Issue on Sensemaking. *Human-Computer Interaction*, 26, 1-8. doi:10.1080/07370024.2011.556557
- Rogers, Y., Sharp, H., & Preece, J. (2011). *Interaction design: beyond human-computer interaction*. John Wiley & Sons.
- Russell, D., Jeffries, R., & Irani, L. (2008). Sensemaking for the rest of us (pp. 1-7). Presented at the CHI 2008 Workshop on Sensemaking, Florence
- Russell, D. M., Stefik, M. J., Pirolli, P., Card, S. K. (1993). The Cost Structure of Sensemaking. Proceedings, InterCHI '93 (pp. 269-276), Amsterdam, Netherlands.
- Scheuer, O. & Loll, F. & Pinkwart, N., & McLaren, B. (2010). Computer-supported argumentation: A review of the state of the art. *Computer-Supported Collaborative Learning*, 5, 43-102.
- Siemens, G. (2012). *Change MOOC: Sensemaking and Analytics*. Connectivism. Retrieved from <http://www.connectivism.ca/?p=341>
- Siemens, G. (2004). *Connectivism: A learning Theory for the Digital Age*. Retrieved from <http://www.elearnspace.org/Articles/connectivism.htm>
- Snowden, D. (2002). Complex Acts of Knowing: Paradox and Descriptive Self-Awareness. *Journal of Knowledge Management*, 6(20), 100-111.
- Taylor, P. & Medina, M. N. (2013). Educational Research Paradigms: From Positivism to Multiparadigmatic. *Journal of Meaning-Centered Education* 1.
- Thompson, E., & Stapleton, M. (2008). Making sense of sense-making: Reflections on enactive and extended mind theories. *Topoi*, 28(1), 23-30. doi:10.1007/s11245-008-9043-2
- Thorndike, E. (1932). *The Fundamentals of Learning*. New York: Teachers College Press.
- Tiles, J. (1987). Meaning. In R. L. Gregory (Ed.), *The Oxford Companion to the Mind* (pp. 450-454). New York, NY: Oxford University Press.
- Verberne, S. (2010). *In Search of the Why: Developing a system for answering why-questions*. Doctoral Dissertation, Radboud Universiteit, Nijmegen, The Netherlands.
- Weick, K. E. (1995). *Sensemaking in organizations*. Foundations for Organizational Science. Thousand Oaks, CA: Sage Publications.
- Whiteside, A. L. (2007). *Exploring social presence in communities of practice within a hybrid learning environment: A longitudinal examination of two case studies within the School Technology Leadership graduate-level certificate program*. Ann Arbor, MI: ProQuest.
- Yang-Turner, F., & Lau, L. (2012). Human Factors in Forum Exploration: A Sensemaking Perspective. Retrieved from http://imash.leeds.ac.uk/event/pdf/Yang-Turner_11.pdf

Fostering change of views of the nature of scientific theories in a CSCL environment

Pei-Jung, Li^{a*}, Huang-Yao, Hong^a

^a*Department of Education, National Chengchi University, Taiwan*

*101152005@nccu.edu.tw

Abstract: This study investigated whether engaging students in knowledge-building help them develop more informed views regarding the nature of scientific theories. Findings indicated that students' views of the nature of scientific theories became more constructivist-oriented toward the end of the semester. A relationship was also observed between students' online activities and their changed views about the nature of scientific theories.

Keywords: Knowledge building pedagogy, Computer supported collaborative learning, Nature of scientific theory.

1. Introduction

Recent educational research shows that promoting students' understanding of the nature of science can help them understand science more deeply (Songer & Linn, 1991; Tsai, 1998; Lee, 2002). However, research in the investigation of students' perspectives of the nature of science showed that many students, even teachers, still see science as absolutely objective and definite; as such, they believe learning science is equivalent to memorizing a bunch of scientific facts. The teaching of science also emphasizes rote-learning rather than deep understanding. Consequently, students often do not know how to apply what they learned and eventually lost their interest in, and motivation to learn, science. Researchers need to investigate how to create a learning environment that can better encourage students to learn in a more autonomous and self-directed manner, and to guide them to construct their knowledge through learning-by-participating in various educational and cultural activities, rather than just highlighting knowledge telling and acquiring. To this end, this study adopted an instructional approach called 'knowledge building'. Knowledge building theory and pedagogy was originally proposed by Carl Bereiter and Marlene Scardamalia (2006), and it is manifested by twelve knowledge building principles that highlight intentional, self-directed learning and are different from conventional instructional approaches in Taiwan that emphasize knowledge-telling. For example, the principle of "real ideas and authentic problems" argue for the importance of using real-life related problems to engage students in working with their own ideas as a start of self-paced learning; and this is different from the kind of learning usually involved learning based on textbook knowledge. Other principles are such as improvable ideas; constructive uses of authoritative source, and epistemic agency (see Scardamalia, 2002, for details). Building on these principles, this study employed a knowledge building environment called Knowledge Forum, as an online forum for open-ended discussion and inquiry, where students could bring up issues or inquire topics they were interested in and responded to other peers with their own experiences or knowledge they learned in the past. The instructional goal is to guide students to work through a process similar to how scientists work with ideas by means of exploring a better explanation for an observed natural phenomenon. It is posited that engaging student in knowledge building process can help them develop a more informed and constructivist-oriented views of the nature of scientific theories.

2. Method

Participants were fifty-two college students in Taiwan who took a course titled "Introduction of Natural Sciences". The duration of the course was eighteen weeks. At the beginning of the semester, the participants brought up issues they were interested in inquiry in the discussion forum and then they used

the design features in the forum to conduct their inquiry (e.g., using scaffolds such as “I need to understand...”, “My theory...”, “This theory cannot explain...”, “New information...”, “A better theory...”, and “Putting our knowledge together...”), and to advance their knowledge in the community. Figure 1 shows a snapshot of students’ online discussion.

The data collected in this study included participants’ activities in the discussion forum and a survey. The survey was administered at the beginning and the end of the semester and used five open-ended questions as following: 1) What is scientific theory? 2) Are there good and bad theories? Why? 3) Where does a scientific theory come from? 4) Are scientific theories invented or discovered? Why? 5) Why do we need scientific theory? The survey was administered to assess participants’ views of the nature of scientific theories.

For the purpose of analysis, the pre and post survey was examined using a coding scheme emerged from a process of reading and re-reading the raw data. Five coding themes emerged were as follows: theory-independent vs. theory-dependent, single research method vs. diverse research methods, non value-laden vs. value-laden, discovery vs. invention, and permanent vs. temporary. Theory-independent means that students consider theories as objective presentation of a phenomenon without personal interpretation or inference; vice versa, theory dependent means that students think theories can be influenced by social factors, previous theories, and prior research results, and can further influence other research/theory. The second “single research method vs. diverse research methods” category assesses whether students consider that the generation of a theory involves repetitive validation using a or mixed single research methods. The third category of “non value-laden vs. value-laden” assess whether students think that theory could be judged as good or bad according to some specific standards. The fourth “discovery vs. invention” category assesses whether students consider theory as resulted from imagination and interpretation. The last category of “permanent vs. temporary” assesses whether students think that theory could be changed or replaced by better theory. The pre and post surveys were then further rated with a five-point Likert scale for each code. Take “permanent and temporary” as example, point one indicated that the participant tended to see scientific theory as infinite existence and unchangeable, whereas point five referred to a perspective that sees a scientific theory as replaceable by a better theory. The results of coding were statistically examined with t-test to see if there were any changes in the views of the nature of scientific theories over time.

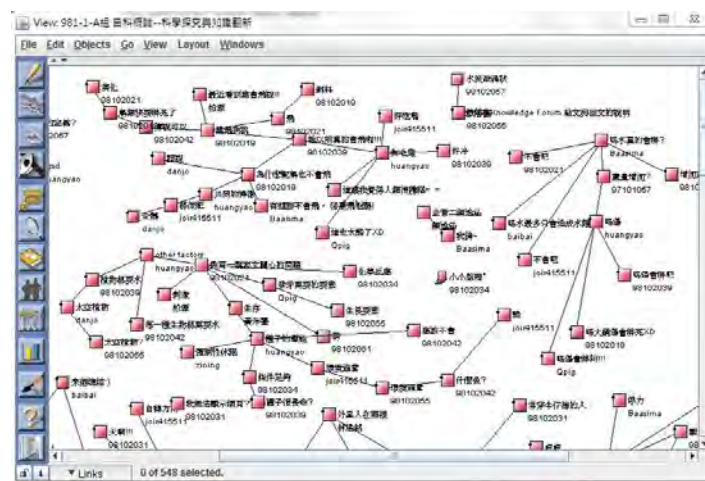

Figure 1. An example of the discussion activities in Knowledge Forum

Further, participants’ activities in the forum was analyzed by a tool called Analytic Toolkit (ATK) that was built-in in the forum for a purpose of obtaining quantitative data regarding online activities (e.g., their interaction). The content of online inquiry and discussion was content-analyzed using a coding scheme modified based on Zhang’s (2007) coding categorization of scientific concepts. There are six levels ranging from less-developed to well-developed scientific concepts. They are non-scientific concept, pre-scientific concept, hybrid concept, basically-scientific concept, scientific concept, and theory construction. Take non-scientific level for example, students’ note content is such as: “I don’t really remember... but this is a good way. So I’ll dry it (my jeans) inside out from now on!” or “It’s (plastic bags) not good to eat! Does this represent the feelings of germs? Though I think it’s kinda cute.”

Such content contains information (e.g., social chat) that is not very useful for or relevant to the development of scientific concepts. To elaborate further, pre-scientific concept (and hybrid concept) mean that students try to address questions mainly based on their personal experiences. Basically-scientific concept or scientific concept means that students can use constructive or proven scientific concepts to address questions. A key difference between these two categories is if students can provide better explanations. The highest level of theory construction means that students can further propose higher-level assumptions to develop a topic or to refute/challenge previous scientific concepts with higher level thinking and understanding.

In addition, the analysis of online activities in the forum was conducted with “week” as the unit of analysis, focusing on a given topic and its corresponding discussion. The entire semester was divided into two periods with mid-term (week 9) as the cutoff point to observe changes from the first half to the latter half of the semester. To understand the relationship between online forum activities and participants’ changes in their views of the nature of scientific theory, participants’ online activities were categorized based on the following characteristics: contribution activity, reading activity, improvement activity, and collaborative activity (see Table 1). Then, correlation analysis and a pair-sample t-test were conducted to observe whether there was a relationship between the number of each coding category and activities in the forum. Last, this study analyzed what participants inquired in the forum, and whether these inquiring activities were also related to participants’ changes of views of the nature of scientific theories. Due to the large amount of data, only half of the inquiry topics were selected for this analysis.

Table 1. Coding table of the activities in the forum

Types of activity	Item	Description
Contribution activity	- Number of notes contributed	- Note contribution as a fundamental online activity in the discussion forum.
Reading activity	- Nnumber of notes - total times for all notes read	- Reading others’ notes indicates community awareness (i.e. whether a participant cares about others’ ideas or not). - The total number of times of all notes read indicates the intensity of reading activity.
Improvement activity	- Number of notes revised - number of times scaffolds used	- Number of note revisions indicates that to what degree a participant reflects on his/her ideas. - Number of scaffolds used represents the degree of higher-order thinking in relation to idea advancement by a participant.
Collaborative activity	- Percentage of notes connected with others’ notes, - Percentage of build-on notes	- Connecting with others’ notes indicates that a participant collaborates with others to improve the ideas and discuss about related issues. - Build-on notes (i.e. replying to other’s notes) show that a participant responds and discusses by working with others’ ideas.

3. Result

3.1 Changes in the views of the nature of scientific theories

As shown in figure 2, the results indicated that there were significant changes in the five aspects as assessed at the end of the semester. The detailed statistics are as follows: (1) “Theory-independent vs. Theory-dependent” ($t=-4.77$, $p<.001$); (2) “Single research method vs. Diverse research methods” ($t=-6.53$, $p<.001$); (3) “Non value-laden vs. Value-laden” ($t=-3.05$, $p<.05$); (4) “Discovery vs. Invention” ($t=-3.80$, $p<.001$); and (5) “Permanent vs. Temporary”, ($t=-4.35$; $p<.001$). In brief, participants’ views of the nature of scientific theories were initially inclined to a more uniform view that sees theory as objective and permanent truth. Toward the end of the semester, their views became more

informed and diverse; they tended to see theory was tentative explanation for certain observed phenomenon and could be modified or falsified.

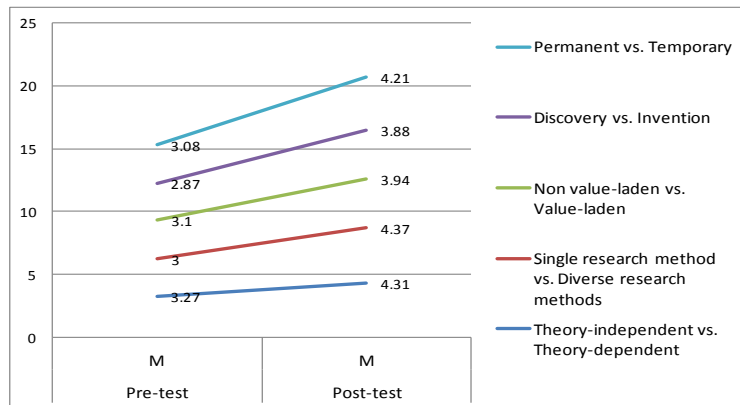

Figure 2. Students' pre- and post-survey results regarding their views of the nature of scientific theories

3.2 Relationship between forum activities and view changes

First, as baseline information, participants' basic online activities and the correlations among these activities were described as follows (see Figure 3 & Table 2). Furthermore, regarding correlations between participants' online forum activities and their changes in views of the nature of scientific theories, Table 3 shows the results. In this analysis, participants were divided into two groups based on the degree of changes in their views of the nature of scientific theories, with 50% as the cutoff point. Moreover, each category of the activity was divided into high- and low-frequency activities. A crosstab analysis was conducted to examine the relationship. Overall, the results showed that the range of participants' changes towards more diverse views of the nature of scientific theory at the end of the semester was highly related to the amount of activities on the computer-supported collaborative learning forum in this study: (1) the number of students with low pre-post change scores and low online activities is 58; (2), the number of students with high pre-post change scores and high online activities is 62; (3) the number of students with high pre-post change scores and low online activities is 42; and (4) the number of students with high pre-post change scores and low online activities is 46 ($X^2 = 4.93, p < .05$).

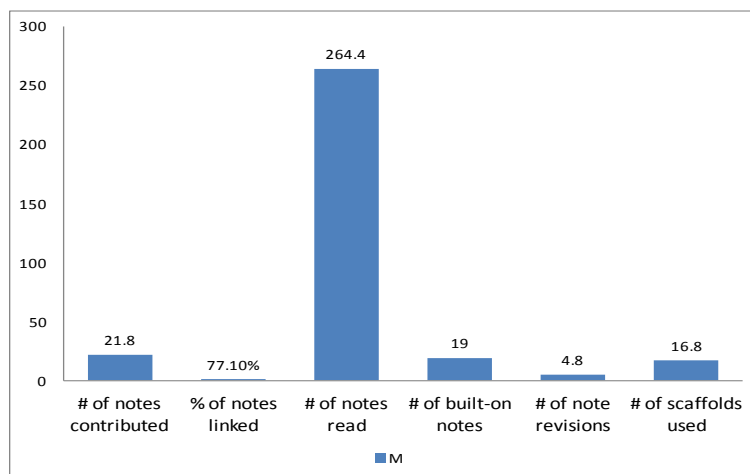

Figure 3. Descriptive analysis of participants' activities in the forum

Table 2. Pearson correlation among forum activities

	1	2	3	4	5	6
1. # of notes contributed	1	0.46**	0.37**	0.86**	0.69**	0.47**
2. % of notes linked		1	0.19	0.38**	0.46**	0.95**
3. # of note revision			1	0.47**	0.29*	0.20

4. # of scaffolds used				1	0.69**	0.38**
5. # of notes read					1	0.43**
6. # of built-on notes						1

*<.05, **<.001

Table 3. Crosstab analysis of participants' change and online activities

Types of activity/ Views		Contribution		Reading		Improvement		Collaboration	
		Low	High	Low	High	Low	High	Low	High
Change between pre-post tests	Low scores	17	8	14	11	14	11	13	12
	High scores	9	18	12	15	12	15	13	14

*<.05

3.3 Relationship between participants' online inquiry activities and their view change

Further, we analyzed the overall topics discussed within groups. Because class members were randomly assigned to one of the two groups and there was too much data, we only randomly selected one group for further analysis. There were fifty-eight topics and eleven sub-topics inquired in the discussion of this group (Group A) over the whole semester. Each topic lasted for an average of 5.26 weeks (SD=3.31), had 7.89 participants on average (SD=4.97), included 11.55 notes on average (SD=9.7), and had been read by 20.3 students on average (SD=7.92). Moreover, the results indicated that in the first half of the semester, participants' discussion tended to involve social and evaluative languages (non-scientific concepts), and pre-scientific concepts. They tended to use their personal experience and conjecture without providing any scientific evidence. But in the latter half of the semester, participants started to use more structural scientific concepts, including hybrid concepts, basic scientific concepts, and scientific concepts. They brought scientific theories, scientific knowledge into their discussion of the topic and then debated or proposed new ideas for future development. Regarding relationship analysis, the results of Chi-square showed that during the first half of the semester, participants didn't provide convincing information in the discussion. After participating in the forum activities for nine weeks, they started to use more persuasive theories or scientific information to support their arguments, and they also discussed or debated more with others. Using Chi-square analysis, there is a significant change from phase 1 to phase 2 in terms of the (high vs. low) level of scientific concepts students discussed in their inquiry ($X^2=7.50, p<.05$).

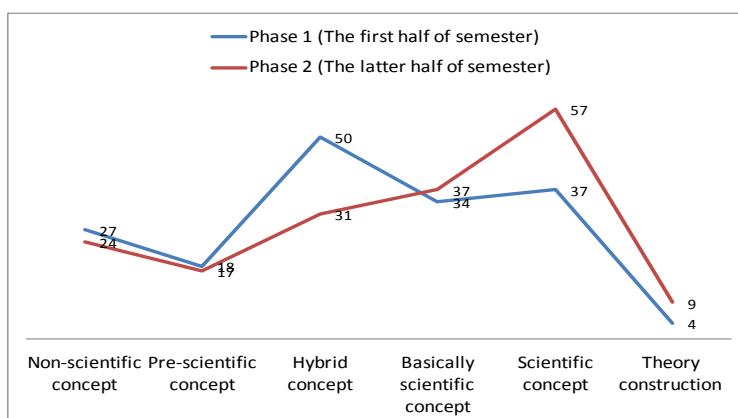

Figure 4. Assessment of the quality of online inquiry between Phase 1 (weeks 1-9) and Phase 2 (weeks 10-18)

4. Conclusion

The purpose of this study was to investigate whether a computer-supported collaborative learning environment that was designed based on knowledge building pedagogy and principles could guide students to develop more informed and diverse views of the nature of scientific theories. First, the results indicated that participants' views of the nature of scientific theory changed significantly after they participated in the forum activities. Second, the results showed that forum activities were

positively correlated with participants' view change. Finally, it was also found that participants used more structural scientific ways to discuss and debate with others towards the latter half of the semester than in the first half. This was similar to how scientists conduct scientific investigation. In addition, it was found that more structural ways of inquiry was also related to participants' view change. Through the use of a computer-supported collaborative knowledge building environment that provided students with more autonomy and flexibility to inquire and discuss online, students were able to change from using more subjective personal opinions and experience to support their arguments, to using more structural and explanatory scientific ways of inquiry to support their knowledge work. As a result, they also developed more constructivist-oriented and diverse views of the nature of scientific theories, which help them to see theories as improvable and falsifiable, instead of unchanged and authoritative.

References

- Gloor P.A. (2006) *Swarm creativity: competitive advantage through collaborative innovation networks*. New York : Oxford University.
- Lee, Y. M. (2002). *A Research of Elementary Students' Views Toward the Nature of Science*. (Unpublished master dissertation). Taipei Municipal University of Education. Taipei, Taiwan.
- Palmquist, B. C., & Finley, F. N. (1997). Preservice teacher' s views of the science during a postbaccalaureate science teaching program. *Journal of Research in Science Teaching*, 34(6), 595-615.
- Scardamalia, M. (2002). Collective cognitive responsibility for the advancement of knowledge. In B. Smith (Ed.), *Liberal education in a knowledge society* (pp. 67-98). Chicago: Open Court.
- Scardamalia, M., & Bereiter, C. (2006). Knowledge building: Theory, pedagogy, and technology. In K.Sawyer (Ed.), *Cambridge handbook of the learning sciences*. Cambridge: Cambridge Univ.
- Songer, N. B., & Linn, M. C. (1991). How do students view of science influence knowledge integration ? *Journal of Research in Science Teaching*, 21(4), 409-421., 28, 761-784.
- Tsai, C. C. (1998). An analysis of scientific epistemological beliefs and learning orientations of Taiwanese eighth graders. *Science Education*, 82(4), 473-789.
- Zhang, J., Scardamalia, M., Lamon, M., Messina, R., & Reeve, R. (2007). Socio-cognitive dynamics of knowledge building in the work of 9- and 10-year-olds. *Education Tech Research Dev.* ,55, 117-145

MuPeT: A Framework for Enabling Multi-Perspective Problem Elaboration

Sven MANSKE, Jesús Omar ÁLVAREZ MÁRQUEZ, Adam GIEMZA, H. Ulrich HOPPE
Faculty of Engineering, University of Duisburg-Essen, Duisburg, Germany
{manske, giemza, hoppe}@collide.info, jesus.alvarez-marquez@uni-due.de

Abstract: Creativity techniques gain importance in education and business areas day by day. Beyond the well-known brainstorming, which focuses on divergent thinking, lateral thinking will encourage the individual to regard the situation from a variety of perspectives by breaking old mind patterns and forming new connections and perceptions. Examples like „Six Thinking Hats“ or „(Walt) Disney Method“ consist of group discussions, where specific roles are assigned to the participants to enforce a discourse with different perspectives. Electronic group discussion systems can compensate the deficits of verbal (face-to-face) discussions through motivating passive discussants to participate. Furthermore, a system can provide a persistent logging of contributions and an explicit representation of a contribution according to the perspective of the participant. We present a novel approach, which allows both authoring and performing such multi-perspective creativity methods. In addition, the participant’s user interface is optimized for mobile devices. Finally we show first results of usability evaluations covering authoring and performing of a created method.

Keywords: Creativity techniques, group discussions, critical thinking, web-based learning

1. Introduction

Nowadays, internet and communication technologies (ICT) are present in nearly all areas of life in our society. The easy access to digital libraries and a variety of sources of information leads to a higher complexity, as the use of these knowledge sources turns into a requirement for individuals. The increasing complexity of this information and knowledge society inhibits the risk of uncertainty and personal overload as a consequence.

To accommodate to this knowledge society, there is a need to foster so-called 21st century skills. Abilities for problem-identification and problem-solving become more and more important in our daily life. This encompasses both the educational sector and business areas. Especially the movement from instructional to constructivist teaching methods demands critical thinking and active construction of knowledge from the students.

A solution to this dilemma will be the reduction of the information and knowledge society’s complexity. This can be achieved through abstraction, modelling, the use of tools and cognitive scaffolds. A key to problem-identification, problem-solving and decision-making is critical thinking, which elicits metacognitive skills to establish evidence on observation in order to judge on a specific problem. When performed in groups, such tasks include discussion and evaluation of others’ ideas. Former research has shown that collaborative learning enhances critical thinking (Gokhale, 1995, Johnson, Johnson, & Smith, 1991) and planning skills (Gauvain & Rogoff, 1989).

Electronic meeting systems can compensate some of the deficits of verbal (face-to-face) discussions (Nunamaker, Dennis, Valacich, Vogel, & George, 1991). In virtual teams it is easier to motivate passive discussants to participate, because the given anonymity reduces the barrier to contribute. Beyond that, such systems could provide moderation support

and explicit representations of contributions according to the context and perspective of the participants.

We propose a framework system for the authoring of creativity methods in the notion of multi-perspective problem-elaboration called MuPeT (“Multi-Perspective Thinking”). Prominent examples of methods applying to this category are the “Disney Method” (Dilts, Epstein, & Dilts, 1991) and De Bono’s “Six Thinking Hats” (De Bono, 1985). These methods are two examples, which can be applied in groups using MuPeT. The system provides means to add new creativity methods by *authors*. A dedicated interface for *moderators* allows for orchestrating a collaborative session. Finally, *participants* contribute in a collaborative session by adding cards to a shared space. A card represents ideas and concepts, and can relate to other cards. This relation is expressed by attaching a card to another, forming a pile of cards. The result will be a semi-structured space, reflecting the whole group discussion.

The structure of this paper is as follows: Section 2 provides a short overview about the background and related work. In section 3, an overview of the framework and implementation is given, emphasizing the three different roles in using the system. Section 4 summarizes two usability evaluation pilots focusing on the *author’s* interface. Finally, section 5 summarizes our findings and presents our future work concerning the MuPeT system.

2. Background and Related Work

The MuPeT system can be used to create methods for multi-perspective group discussions. There is a strong intersection between these kinds of group discussion and creativity-techniques, which can be applied to groups. A very prominent creativity technique is De Bono’s “Six Thinking Hats” (De Bono, 1985) in which participants wear hats in different colors representing different perspectives or ways of thinking in a group discussion. The goal is to foster a more efficient discourse about a topic without missing important viewpoints. A second prominent creativity technique is the “Disney Method”. The Disney method has been developed by (Dilts, Epstein, & Dilts, 1991). It is similar to the Six Thinking Hats and can be seen as a simpler version of it, consisting of three perspectives (*Dreamer, Realist, and Critic*) in a parallel thinking setting.

MuPeT supports both creativity techniques and is designed to foster collaborative and metacognitive skills. Former research has shown that collaborative learning enhances critical thinking (Gokhale, 1995). MuPeT furthermore follows a specific type of collaborative activities, namely Think-Pair-Share. This process has some benefits on the learning of the participants: In sharing their ideas, students take responsibility of their own learning. They negotiate meanings, discuss ideas, and do not rely solely on the teacher's authority, which forces critical thinking (Cobb, et al., 1991). Although this learning strategy has its foundations in non-electronic collaborative learning, it can also be applied to CSCL (Gallupe, Dennis & Cooper, 1992, Aiken, 1992). In MuPeT, cards represent ideas or concepts, the pairing appears in the system’s shared space and in a follow-up discussion, and participants share their ideas and solutions. The novelty of the presented approach is in the flexibility of the framework, which enables to author the underlying methods for group-discussions and the creativity techniques. In contrast to this, several systems exist, which focus on very specific creativity methods (Six Thinking Hats in *De Bono Thinking 24x7*¹) or very general supporting group discussion or idea generation without putting emphasis on preserving or highlighting different perspectives (*MindMeister*² or *Daedalus InterChange*³).

¹ De Bono Thinking 24x7: http://www.debonoconsulting.com/de_Bono_Thinking_24x7_Software.asp, retrieved May, 26th 2014.

² MindMeister, MeisterLabs GmbH: <http://www.mindmeister.com/>, retrieved May, 26th 2014.

³ Daedalus InterChange, The Daedalus Group: http://www.daedalus.com/products_diwe_overview.asp, retrieved May, 26th 2014.

3. MuPeT System

With the goal of fostering critical, lateral and divergent thinking, we apply a modified Think-Pair-Share approach to create such system. We developed a framework to create methods for problem elaboration and group discussion with some degrees of freedom: Groups, parallel or non-parallel thinking, the number of perspectives and participants and possible recurrences and multiple iterations of the processes. To achieve this, we syndicate the requirements that come from related work and similar systems. This has been implemented in a web-based system, which will be presented in this section. After an overview of the system, technical details concerning the architecture will be shown briefly.

3.1 Multi-Perspective Group Discussions

An example for a creativity technique that is usually applied in a group is the well-known brainstorming. The participants collaboratively produce ideas, which are not only built on their own thinking. They also reflect on others' ideas and rephrase, abstract or mash-up concepts to create more ideas. Such techniques and tools only cover the divergent phase of a problem-solving process, masking emotions, positive and negative aspects. Other techniques incorporate multiple perspectives and more structured information spaces, extending this minimalistic approach to enable group-discussions.

3.2 Requirements

Considering the mentioned creativity methods and the related work, we derive the following requirements for such a system for authoring and performing multi-perspective group discussions:

- Method management: Allow for creating, removing and selecting methods.
- Session management: Sessions need to be recorded to enable persistence of the information, and also to pause them and continue later.
- Multiple perspectives: Following the mentioned creativity techniques, handling of different perspectives is needed.
- Perspective sequences: Methods consist of a queue of perspectives with a dedicated order.
- User management: More general than in the described methods, discussion can also benefit from different perspectives at the same time. Therefore, sequences need to be assigned to different users.
- Roles: Besides the participants, there is the need for a moderator with specific needs.
- Concurrency: Multiple users access the system concurrently when creating concepts and ideas, requiring data consistency.
- Idea representation: A potentially great amount of incoming ideas need to be represented adequately in the system. These ideas might be related and come from different perspectives. This requires a clear and functional visualization.

3.3 Overview of the System

Derived from the requirements, we give a brief overview of the system. Mainly it consists of two different user interfaces, one for the moderator (and author) of methods, another one for the participants. When creating a new method, initially all perspectives need to be created. As a next step, the author can define a sequence of perspective (queue). By default, a queue of all previously defined perspectives is being created. Custom sequences might be useful to create

multiple iterations or custom schemes, as demonstrated in Figure 3. A use case for having more than one queue could be if a custom method consists of different groups of participants, where each group has its own set of perspectives. This can be applied in more controversy group-discussions, e.g. when learning to debate in schools. Such examples would not count as parallel thinking.

In order to facilitate the method, the moderator has to create a session. A session consists of a method on which it is based on and groups of participants. To these groups, queues of perspectives need to be assigned. Having one group for all participants will enable parallel thinking, while several groups can be used for the non-parallel version. After these assignments, the session is ready to accept connections from participants.

The participation mode gives the users the possibility to facilitate a created technique. The participants' interface gives an overview about the current perspectives including the instructions, e.g. the description of the worn hat in terms of Six Thinking Hats. The interface provides the possibility to attach cards to a shared view, and to contribute to the discussion. It supports different representations of cards and reflects which participant created the card from which perspective. The card content can be text entered with a keyboard, or freehand text from a stylus. This can provide an additional benefit of natural input, especially when working on tablet PCs with such digitizer devices. Figure 5 demonstrates the whiteboard mode of the system, which could be easily used to provide a better overview of the current discussion, and to support the convergent or reflection phases at the end of a session.

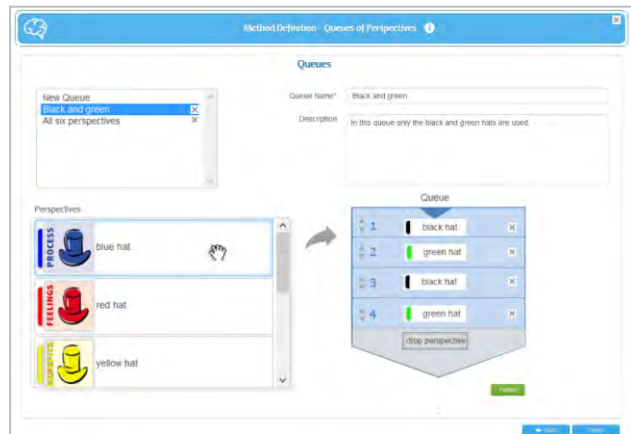

Figure 3. Creation of perspective queues. Different queues consisting of any order of perspectives can be defined for each method. This enables a flexible moderation and adaptation of methods.



Figure 4. The whiteboard mode of MuPeT. In the top bar, the queue of perspectives is displayed highlighting the current one. The canvas contains all cards (color from the perspectives) that have been added to the shared space. A pile of cards visualizes the relation between ideas.

4. Evaluation

The system has been evaluated with focus on the authoring of creativity techniques as first trials indicated that the system is relatively simple for executing the methods in groups. However authoring in general is a complex task and the development of own creativity techniques is quite unnatural and uncommon. Therefore we will describe three evaluation studies that focused on the authoring part of the system.

In the first evaluation, a group of five experts discussed a real world topic (“extending the university with a new building”). Before the actual discussion, the participants had to create a method for the problem elaboration. The experts evaluated most of the functionalities of the system *for authors and participants*. The results are based on Jakob Nielsen’s ten heuristics for user interface design (Nielsen, 1994), performed with a think-aloud protocol. The overall impression of the experts was quite good. However, there were some aspects of the system that can be improved. Most of the usability problems concerning user control, freedom, and error prevention were encountered in the authoring process, when creating new methods. The suggestions have been used as an input for the first redesign iteration, shifting the focus for further evaluations to the moderators view.

The next iteration consisted of two studies. The usability improvement of the interface was further evaluated, focusing on the authoring of methods and orchestration of groups. The Ergonomics of Human System Interaction formed the basis of the evaluation criteria (ISO 9241-110 for dialogue principles and ISO 9241-210 for user experience). Two questionnaires have been used to evaluate these criteria: The User Experience Questionnaire (UEQ) (Laugwitz, Held, & Schrepp, 2008) is used to measure the perceived user experience and the dialogue principles are tested through the ISONORM 9241/110 (Pataki, Sachse, Prümper, & Thüning, 2006) survey. A protocol for the evaluation has been developed to check the user workflow for the authoring and moderation. Initially, 16 users tested the version of the system. Afterwards, the participants were asked to fill out the questionnaires. This output regarding ideas from the think-aloud technique has been used to create further improvements, later evaluated by another 16 participants. Table 1 shows the results of the UEQ questionnaire. The ratings range on a 7-point Likert-scale (-3 , +3).

Table 1: Average and standard deviation of the UEQ evaluation. Group 1 tested the previous version (iteration 1) and group 2 the improved version of iteration 2.

Dimension	Group	AVG	SD
Attractiveness	1	0.78	1.20
	2	1.11	0.77
Perspicuity	1	0.11	1.56
	2	1.14	1.12
Efficiency	1	1.05	0.71
	2	1.34	0.81
Dependability	1	0.50	1.10
	2	1.17	0.95
Stimulation	1	0.98	0.88
	2	1.08	0.86
Novelty	1	0.98	1.01
	2	1.28	0.64

Table 2: Results of the IsoNorm questionnaire for both groups. The values have a range from -3 to +3 on a 7-point Likert-scale.

Dimension	Group	AVG	SD
suitability for the task	1	1.23	1.11
	2	1.54	1.33
self-descriptiveness	1	-0.90	1.33
	2	0.90	1.17
conformity with user expectations	1	0.98	1.31
	2	1.42	1.29
suitability for learning	1	0.77	1.32
	2	1.44	1.53
Controllability	1	0.69	1.11
	2	1.06	1.17
error tolerance	1	0.48	0.85
	2	0.98	1.06
suitability for individualization	1	0.13	1.16
	2	0.63	0.82

In all dimensions of the questionnaire, an improvement can be measured. The evaluation of the IsoNorm questionnaire (cf. Table 2) has proven the positive effect of the usability engineering. The most significant improvements are made on the UEQ Perspicuity and the IsoNorm self-descriptiveness. The results of the second group show that the overall perception of the systems usability is very good, though there is still space for improvement. Future studies will envisage a larger-scale use of the participant’s interface.

5. Conclusions and Future Work

In this paper, we presented a framework for enabling multi-perspective problem elaboration. The implemented system is capable of authoring of new creativity methods and their facilitation in a web-based application. The evaluations showed that the system is well received. For the future, additional experiments are planned to evaluate the participation interface in online-learning scenarios. It will be interesting to see, if such tools can be used to support inquiry-based learning, especially in the context of online labs in the STEM fields (“Science, Technology, Engineering, Mathematics”). Such learning scenarios usually demand activating and supportive teaching techniques. Moreover, the analysis of learning traces and the application of methods of learning analytics can be of interest. How do students create hypotheses, construct their knowledge or reflect on their learning process in discussion phases?

A typical weak aspect of such tools for idea generation is the lack of support for the convergent phase, where the concepts, ideas and solutions are evaluated. A borderline example is the brainstorming, where the result is a collection of unrelated ideas. For such tools, a “post-processing” phase that provides both visual support and also content-analysis would be of interest. This can be a timeline visualization of the idea generation, but also a network built from relations that are extracted on a semantic level.

References

- Aiken, M. (1992). Using a group decision support system as a teaching tool. *Journal of Computer-Based Instruction*, 19 (3), 82-85.
- De Bono, E. (1985). *Six Thinking Hats*. Little, Brown Book Group Limited.
- Dilts, R. B., Epstein, T., & Dilts, R. W. (1991). *Tools for dreamers: Strategies for creativity and the structure of innovation*. Meta Publications Capitola.
- Figl, K., & Mensch, U.-F. i. (2009). ISONORM 9241/10 und Isometrics: Usability-Fragebogen im Vergleich. *Mensch & Computer*, (S. 143-152).
- Gallupe, R. B., Dennis, A. R., & Cooper, W. H. (1992). Electronic brainstorming and group size. *Academy of Management Journal*, 35 (2), 350-369.
- Gauvain, M., & Rogoff, B. (1989). Collaborative problem solving and children's planning skills. *Developmental psychology*, 25(1), 139-151.
- Gokhale, A. A. (1995). Collaborative learning enhances critical thinking. *Journal of Technology Education*, 7.
- ISO 9241-110 Ergonomics of human-system interaction -- Part 110: Dialogue principles. (2006). *ISO 9241-110 Ergonomics of human-system interaction -- Part 110: Dialogue principles*.
- ISO 9241-210 Ergonomics of human-system interaction -- Part 210: Human-centred design for interactive systems. (2010). *ISO 9241-210 Ergonomics of human-system interaction -- Part 210: Human-centred design for interactive systems*.
- Johnson, D. W., Johnson, R. T., & Smith, K. A. (1991). Active learning: Cooperation in the college classroom.
- Laugwitz, B., Held, T., & Schrepp, M. (2008). Construction and evaluation of a user experience questionnaire. In *HCI and Usability for Education and Work* (S. 63-76). Springer.
- Laugwitz, B., Held, T., Schrepp, M., Schubert, U., Ilmberger, W., & Tamm, N. (2009). *Subjektive Benutzerzufriedenheit quantitativ erfassen: Erfahrungen mit dem User Experience Questionnaire UEQ*. Stuttgart: Usability Professionals.
- Nielsen, J. (1994). *Usability engineering*. Elsevier.
- Nunamaker, J. F., Dennis, A. R., Valacich, J. S., Vogel, D., & George, J. F. (#jul# 1991). Electronic Meeting Systems. *Commun. ACM*, 34(7), 40-61. Von <http://doi.acm.org/10.1145/105783.105793> abgerufen
- Pataki, K., Sachse, K., Prümper, J., & Thüring, M. (2006). ISONORM 9241/110-Short: Ein Kurzfragebogen zur Software-Evaluation. *45. Kongress der Deutschen Gesellschaft für Psychologie*.
- Prümper, J., & Anft, M. (1993). Die Evaluation von Software auf Grundlage des Entwurfs zur internationalen Ergonomie-Norm ISO 9241 Teil 10 als Beitrag zur partizipativen Systemgestaltung - ein Fallbeispiel. In K. Rödiger (Hrsg.), *Software-Ergonomie '93 - Von der Benutzungsoberfläche zur Arbeitsgestaltung* (S. 145-156). Stuttgart: Teubner.

The motivational underpinnings of using wikis for collaborative group work

Ronnel B. KING^{a*}, & Samuel K. W. CHU^b

^a*Department of Curriculum and Instruction, The Hong Kong Institute of Education, Hong Kong*

^b*Faculty of Education, The University of Hong Kong, Hong Kong*

*ronnel@ied.edu.hk

Abstract: This study aims to investigate the role of goal orientations on students' engagement in using wikis for collaborative writing. Hong Kong secondary school students (N = 422) participated in the study and answered questionnaires about their goal orientations and their level of engagement when using wikis for collaborative project work. Results showed that students who pursued mastery and social goals were more engaged in their collaborative projects. However, it was students who pursued performance goals who achieved higher grades. Implications for synergizing research on IT in education and motivational psychology are discussed.

Keywords: achievement goals, social goals, wiki, collaborative group work

1. Introduction

In recent years, there has been rapid growth in the use of Web 2.0 tools (also known as Web-based collaboration ware) such as wikis, blogs, podcasts, and RSS feeds (Boulos, Maramba, & Wheeler, 2006; Byron, 2005; Ebner, Kickmeier-Rust, & Holzinger, 2008). The success of Wikipedia is a testament to the widespread dissemination of Web 2.0 technology. Web 2.0 technologies offer a wide range of unique and powerful information sharing and collaboration features.

Educators have begun to harness the potential of Web 2.0 in the school setting (Chu, Chan, & Tiwari, 2012; Fu, Chu, & Kang, 2013; Parker & Chao, 2007; Woo & Chu, 2013). In this paper, we particularly focus on the use of wikis to foster collaborative group work. The word "wiki" comes from the Hawaiian phrase "wiki-wiki" which means quick. It is a system that allows users to create and edit web pages collaboratively (Leuf & Cunningham, 2001). Much of the research on wikis have been conducted by learning technology specialists who were interested in harnessing the affordances of the wiki technology in enhancing the student learning experience (e.g., Chen et al., 2005; Pifarre & Starman, 2011). As such, these studies have usually focused on the technical features of wikis, and how students and teachers use these features in collaborative group work.

A shortcoming of this literature is a lack of attention to the deeper motivational processes that underpin the effective use of the wiki technology for collaborative group work. Different students facing the same wiki tool would exhibit varying degrees of motivation and engagement. Given that all students are exposed to a similar wiki platform why do some students display a greater degree of engagement, while others seem to be more indifferent. What could account for these individual differences in motivation and engagement?

In this paper, we attempt to answer this question by looking at how individual differences in student motivation could account for the differential engagement with the wiki for collaborative learning. Educational psychologists who have studied motivation usually focus on the role of goal orientations as crucial motivational constructs (Covington, 2000). Therefore, in this paper, we examine the role of goals in predicting engagement and achievement when using wiki for collaborative learning.

2. Literature Review

Educational psychologists who study motivation have usually focused on the role of goals on learning and achievement. Goals refer to desired end states and have been shown to predict a wide range of educational outcomes (Huang, 2012; Hulleman, Schragger, Bodmann, & Harackiewicz, 2010).

Early research has focused on two types of achievement goals: mastery and performance goals (Elliot, 1999). Students who endorse mastery goals focus on improving their level of competence and are intrinsically interested in the task. On the other hand, students with performance goals are interested in demonstrating their superiority to others and showing their normative competence. Mastery goals have been shown to be associated with deep learning strategies, intrinsic motivation, effort, persistence among others.

Later researchers have argued that social goals are also important predictors of learning and achievement (King & McInerney, 2014; King, McInerney, & Watkins, 2012, 2013; King & Watkins, 2012). Social goals refer to the pursuit of social outcomes in school (Wentzel, 1994, 1996). There are two main types of social goals: prosocial and social responsibility goals. Students with prosocial goals focus on trying to help their classmates and peers. They are keen to share what they know with others. Students with social responsibility goals are focused on keeping interpersonal commitments to their peers and complying with classroom norms. Research has shown that both prosocial and social responsibility goals were associated with a wide range of adaptive educational outcomes (Wentzel, 1996; 2000).

In this study, we examined the association between the different types of goals that students pursued and their level of engagement in the collaborative wiki group work. Engagement has usually been conceptualized as having three dimensions: behavioral, emotional, and cognitive (Fredricks, Blumenfeld, & Alison, 2004). Behavioral engagement refers to effort, persistence and mental effort such as attention and contribution to class discussion. Emotional engagement covers the energized emotional states such as enthusiasm and interest, while cognitive engagement refers to the use of deeper forms of learning strategies. Cognitively engaged students are not afraid to exert effort to master difficult skills.

Engagement is a crucial construct in student learning given that engaged students learn more in school and achieve higher grades. They are also less likely to drop out of school. Engagement is a malleable construct and has been shown to be influenced by a wide range of factors. The goals that students pursue have been shown to exert an important impact on students' levels of engagement. In particular, mastery goals have been shown to be positive predictors of engagement.

Research examining the link between social goals (prosocial and social responsibility) and engagement are more sparse. However, the few existing studies would suggest a positive linkage between social goals and engagement. Studies have shown that students who try to help their peers (i.e., those who pursue prosocial goals) learn more in the process. Those who try to comply with classroom norms and rules are more likely to have a better overall learning experience (Wentzel, 2000; Wentzel, Filisetti, & Looney, 2007)

The present study examined the relationship between different types of goals (mastery, performance, prosocial, and social responsibility goals) and engagement in collaborative wiki writing. In this study we focused on a group of students who were using wikis to co-create their final group project.

3. Methods

Procedures

The wiki platform PBworks (<http://www.pbworks.com>) was used in this study. Students used this platform for their collaborative inquiry group project in Liberal Studies (LS). A standard PBworks template was created. Using this template, students could add or edit the files and pages. On each page, they could leave comments for internal group discussions. The widget "Recent Activity History" could help group members keep track of the changes on the wiki pages.

On average, each group had four students. The students took 4-5 months to complete the online project. At the end of the project, students responded to a questionnaire which measured their goal orientations and engagement. The final grades for the group work was also obtained.

Participants

There were 422 secondary school students from Hong Kong who participated in the study. All students were from a co-education government secondary school, and their age ranged from 13 to 15.

Instruments

To measure students' goal orientations, the goal questionnaire devised by Wentzel (1994, 1996, 2000) was used. It measures four types of goals: mastery, performance, prosocial, and social responsibility goals. The definitions of these constructs as well as sample items are given below. Note that all questions were modified to pertain to the LS class.

To measure cognitive engagement, we used the deep learning strategies subscale of the Revised Two Factor Study Process Questionnaire (Biggs, Kember, & Leung, 2001). To measure behavioral and emotional engagement, we used the relevant subscales from Skinner, Kindermann, and Furrer's (2009) Engagement and Disaffection Questionnaire. All these scales were modified to pertain to the liberal studies class which was the domain we chose to study in this paper. Questionnaires were answered on a 5-point Likert scale with higher scores indicating a greater endorsement of the construct.

Table 1: Goal constructs, definition, and sample items.

Goal construct	Definition	Sample items
Mastery goal	Wanting to learn as much as possible for intrinsic reasons	How often do you try to learn something new for LS class even if you don't have to?
Performance goal	Wanting to outperform others	How often do you try to show you have learned more than your classmates in LS class?
Prosocial goal	Wanting to help classmates and peers	How often do you try to share what you've learned with your classmates in LS class?
Social responsibility goal	Wanting to keep interpersonal commitments to peers and teachers	How often do you try to do what your LS teacher tells you to do?

4. Results

Preliminary results

We first looked at the descriptive statistics and internal consistency reliabilities. Results showed that all the scales had good psychometric properties with Cronbach's alpha reliabilities ranging from .74 to .84 (see Table 2). Table 3 shows the correlations among the variables.

Table 2: Descriptive statistics and internal consistency reliabilities

	Mean	SD	Cronbach's alpha
Mastery goal	3.36	.66	.83
Performance goal	3.10	.72	.83
Prosocial goal	3.21	.62	.79
Social responsibility goal	3.47	.64	.74
Behavioral engagement	3.62	.58	.82
Emotional engagement	3.59	.58	.84
Cognitive engagement	3.37	.59	.79
Grades	3.09	.72	n/a

Table 3: Zero-order correlations among the variables.

	2	3	4	5	6	7	8
1. Mastery goal	.650***	.610***	.606***	.513***	.535***	.543***	.235***
2. Performance goal	1	.598***	.479***	.341***	.338***	.424***	.272***
3. Prosocial goal		1	.487***	.357***	.431***	.442***	.175***
4. Social responsibility goal			1	.463***	.442***	.455***	.191***
5. Behavioral engagement				1	.791***	.707***	.218***
6. Emotional engagement					1	.755***	.214***
7. Cognitive engagement						1	.180***
8. Grades							1

Note:*** $p < .001$.

Predictive relationships

To examine the relationship between the different types of goals and engagement in wiki collaborative writing, four separate regressions were conducted. The independent variables were the four types of goals: mastery, performance, prosocial, and social responsibility goals. The criterion variables included behavioral engagement, emotional engagement, cognitive engagement, and grades in the wiki project. Table 4 shows the results of the regression analyses.

Table 4: Goals as predictors of engagement and achievement.

	Behavioral engagement	Emotional engagement	Cognitive engagement	Grades
Mastery goal	.369***	.396***	.328***	.075
Performance goal	-.034	-.100	.055	.178**
Prosocial goal	.036	.167***	.127*	-.019
Social responsibility goal	.239***	.168***	.168**	.052
R ²	30.1%***	32.4%***	33.4%***	6.5%***

Note: * $p < .05$; ** $p < .01$; *** $p < .001$

Results indicated that mastery goal was a consistent positive predictor of the three different types of engagement: behavioral, emotional, and cognitive. Social goals were also important predictors. Prosocial goals positively predicted emotional and cognitive engagement, while social responsibility goals positively predicted the three types of engagement. Interestingly, grades on the wiki project was only predicted by performance goals.

5. Discussion

In general, the results of this study suggest that knowing the goals students are trying to achieve in school can explain, in part, how engaged they are when doing collaborative group work on a wiki platform. In particular, it was shown that mastery, prosocial, and social responsibility goals predicted engagement, while performance approach goals predicted actual achievement.

When students come into the classroom, they already bring with them a certain psychological baggage. Part of this baggage are the goals that they pursue in school. Psychological research has shown that different types of students would pursue different types of goals. It would be naive to assume that all students will be equally engaged when doing collaborative group work in wiki. Thus, teachers are advised to attend to the types of goals that students bring with them. Studies have shown that these goals are highly malleable and that teachers have an important role to play in shaping the types of goals that students would pursue (Jang, Reeve, & Deci, 2010; King & Ganotice, 2014).

Results of our study indicated that mastery, prosocial, and social responsibility goals were important predictors of behavioral, emotional, and cognitive engagement. Mastery goals have been

associated with a wide range of positive outcomes in previous research. Thus, it was not surprising to find mastery to positively predict all the three types of engagement

An interesting feature of our study was the inclusion of prosocial and social responsibility goals. Most educational psychologists fail to investigate the correlates of these goals and focus exclusively on mastery and performance goals. We thought that social goals would be especially important in collaborative settings. When students work with each other, goals aimed at helping each other (prosocial goal) and trying to keep promises and commitments to each other (social responsibility) would facilitate the cooperative learning process. Therefore, it is likely that social goals are especially important in collaborative group work. This assumption received support in the current study. We found that both types of goals positively predicted engagement.

Another interesting finding was that of all the four types of goals investigated only performance goals positively predicted grades in the wiki project. Performance goals have been associated with both positive and negative outcomes in previous research. For example, performance-oriented students have been found to use more superficial learning strategies and were anxious. However, performance approach goals have been consistently associated with higher levels of academic achievement (e.g., Huang, 2012; Hulleman et al., 2010) and these results were replicated in our study. This

6. Conclusion

Taken together, results of the current study showed that goals were important predictors of engagement in a collaborative wiki environment. This study has important theoretical implications for bridging research in educational psychology with the literature on IT in education.

IT in education researchers have traditionally been interested in the use of information technologies for improving the student learning experience. However, they have paid insufficient attention to the role of motivational factors in influencing the quality of learning in technologically-enriched environments.

On the other hand, educational psychology researchers have conducted a number of studies on the role of goals in traditional classroom settings where the learning structure is mostly individualistic. They have not investigated how these goals would play out in a collaborative and technologically-enriched learning environment.

This study showed the possible synergies that could emerge by linking information technology research with educational psychology theorizing. It also has important practical implications. To facilitate learning, teachers are encouraged to cultivate students' mastery and social goals. Mastery goals could be encouraged by designing interesting and meaningful tasks. The use of norm-referenced assessment and evaluation could also be decreased. Collaborative group work has been shown to increase students' prosocial and social responsibility goals. Therefore, teachers could encourage the use of collaborative strategies to improve student learning (Johnson & Johnson, 2009).

References

- Biggs, J. B., Kember, D., & Leung, D. Y. P. (2001). The revised two-factor Study Process Questionnaire: R-SPQ-2F. *British Journal of Educational Psychology, 71*, 133-149.
- Boulos, M. N. K., Maramba, I., & Wheeler, S. (2006). Wikis, blogs and podcasts: A new generation of Web-based tools for virtual collaborative clinical practice and education. *BMC Medical Education, 6*, 41.
- Byron, M. (2005). Teaching with Tiki. *Teaching Philosophy, 28*, 108-113
- Chen, H. L., Cannon, D., Gabrio, J., Leifer, L., Toye, G., & Bailey, T. (2005). Using wikis and weblogs to support reflective learning in an introductory engineering design course. *Proceedings of the 2005 American Society for Engineering Education Annual Conference and Exposition*. Portland, Oregon: June 12-15.
- Chu, S. K. W., Chan, C. K. K., & Tiwari, A. F. Y. (2012). Using blogs to support learning during internship. *Computers & Education, 58*, 989-1000
- Covington, M. (2000). Goal theory, motivation, and school achievement: An integrative review. *Annual Review of Psychology, 51*, 171-200.
- Ebner, M., Kickmeier-Rust, M., & Holzinger, A. (2008). Utilizing wiki-systems in higher education classes: A chance for universal access? *Universal Access in the Information Society, 7*, 199-207.

- Elliot, A. J. (1999). Approach and avoidance motivation and achievement goals. *Educational Psychologist, 34*, 169-189.
- Fu, H., Chu, S.K.W., & Kang, W. (2013). Affordances and constraints of wiki for primary-school students' group projects. *Journal of Educational Technology & Society, 16*, 85-96.
- Huang, C. (2012). Discriminant and criterion-related validity of achievement goals in predicting academic achievement: A meta-analysis. *Journal of Educational Psychology, 104*, 48-73.
- Hulleman, C. S., Schrager, S. M., Bodmann, S. M., & Harackiewicz, J. M. (2010). A meta-analytic review of achievement goal measures: Different labels for the same constructs or different constructs with similar labels? *Psychological Bulletin, 136*, 422-449.
- Jang, H., Reeve, J., & Deci, E. L. (2010). Engaging students in learning activities: It is not autonomy support or structure but autonomy support and structure. *Journal of Educational Psychology, 102*, 588-600.
- Johnson, D. W., & Johnson, R. T. (2009). An educational psychology success story: Social interdependence theory and cooperative learning. *Educational Researcher, 38*, 365-379.
- King, R. B., & Ganotice, F. A. (2014). The social underpinnings of motivation and achievement: Investigating the role of parents, teachers, and peers on academic outcomes. *The Asia Pacific Education Researcher, 23*, 745-756.
- King, R. B., & McInerney, D. M. (2014). Culture's consequences on student motivation: Capturing cross-cultural universality and variability through personal investment theory. *Educational Psychologist, 49*, 175-198.
- King, R. B., McInerney, D. M., & Watkins, D. A. (2012). Studying for the sake of others: The role of social goals on academic engagement. *Educational Psychology, 32*, 749-776.
- King, R. B., McInerney, D. M., & Watkins, D. A. (2013). Examining the role of social goals in school: A study in two collectivist cultures. *European Journal of Psychology of Education, 28*, 1505-1523.
- Leuf, B., & Cunningham, W. (2001). *The wiki way: Quick collaboration on the web*. Boston: Addison-Wesley.
- Parker, K. R., & Chao, J. T. (2007). Wiki as a teaching tool. *Interdisciplinary Journal of Knowledge and Learning Objects, 3*, 57-72.
- Pifarre, M., & Staarman, J. K. (2011). Wiki-supported collaborative learning in primary education: How a dialogic space is created for thinking together. *International Journal of Computer-Supported Collaborative Learning, 6*, 187-205.
- Skinner, E. A., Kindermann, T. A., & Furrer, C. J. (2009). A motivational perspective on engagement and disaffection: Conceptualization and assessment of children's behavioral and emotional participation in academic activities in the classroom. *Educational and Psychological Measurement, 69*, 493-525.
- Wentzel, K. R. (1994). Relations of social goal pursuit to social acceptance, Classroom behavior, and perceived social support. *Journal of Educational Psychology, 86*, 173-182.
- Wentzel, K. R. (1996). Social and academic motivation in middle school: Concurrent and long-term relations to academic effort. *The Journal of Early Adolescence, 16*, 390-406.
- Wentzel, K. R. (2000). What is it that I'm trying to achieve? Classroom goals from a content perspective. *Contemporary Educational Psychology, 25*, 105-115.
- Wentzel, K. R., Filisetti, L., & Looney, L. (2007). Adolescent prosocial behavior: The role of self-processes and contextual cues. *Child Development, 78*, 895-910.
- Woo, M. & Chu, S.K.W. (2013). Peer-feedback and revision process in wiki mediated collaborative writing. *Educational Technology Research & Development, 61*, 279-309.

Learning about Reflection Processes: An Analysis of Learners' Observation of Experts

Akio TAKASHIMA^a

^a *Shohoku College, Japan*

*akio.takashima.shohoku@gmail.com

Abstract: Both reflection-in-action and reflection-on-action are important, especially in creative design work. Although school curricula teach the technical side of design, they do not teach the psychological side, represented by the reflection process. The goal of this research is to support learners to understand experts' reflection processes in relation to design. This paper describes experts' reflection-in-/on-action processes in design, and how learners observe this from video data on the design process, and on eye-tracking of an expert designer. The findings are helpful for designing environments that support students to learn about experts' reflection processes.

Keywords: reflection-in-action, reflection-on-action, design process, student learning, eye-tracking

1. Introduction

The goal of this research is to help learners understand experts' reflection processes in the context of design.

Schoen describes design as a reflective conversation with the material of a situation, and distinguishes two types of reflection: reflection-in-action and reflection-on-action (Schoen 1983). Reflection-in-action is the reflective process that takes place while externalizing representation, while reflection-on-action occurs when a designer views a result of representation. Both types of reflection are important, especially in creative design work.

Although school curricula teach the technical side of design, they do not teach its psychological aspects, which is represented by the reflection process. For this reason, the student has to establish his/her style over many long years, or has to learn it practically through on-the-job trainings of a company.

This paper describes experts' reflection-in-/on-action processes in design, and how learners observe these processes from video data.

2. Reflection-in-/on-Action in Design

In addition to physical sketches, supportive computer-based tools are useful to designers. Nakakoji et al. describe the approach of using two-dimensional spatial positioning of piece of document as a representation that is useful for reflection in the early design of documentation (Nakakoji et al. 2000). They argue that position as a state is closely related to reflection-on-action, while positioning as an action is closely related to reflection-in-action. In other words, reflection on the results of a previous action is regarded as reflection-on-action, and reflection while taking the action is regarded as reflection-in-action. The approach taken by Nakakoji et al. guides the present research.

3. Preliminary Study

For the purpose of examining students' interest in learning from experts' processes of creation, we used two tasks: we conducted a questionnaire survey and we asked the students to list their awareness of

expert behavior based on video viewing. The participants consisted of a total of 14 first- and second-grade college students. All participants were majoring in media design.

3.1 Questionnaire Survey

A questionnaire survey was conducted in order to examine students' interest in learning about media design. The questionnaire items are listed in Table 1, and the results relating to question 1 and question 2 are shown in Figure 1 and Figure 2, respectively. As shown in Figure 1, the students feel that watching video representations of the design process is an effective form of learning. Figure 2 indicates that all the students are interested in both the technical and psychological aspects of experts' creation processes.

Table 1: Question items for the survey

Q1	Which types of media are most effective in learning about experts' creation processes? <books, images, videos, Web, dialogue, others> (Multiple answers allowed)
Q2	What is your level of interest in the technical/psychological aspects of experts' creation processes? <None: 0 pt, Very little: 1 pt, Some: 2 pts, A great deal: 3 pts>

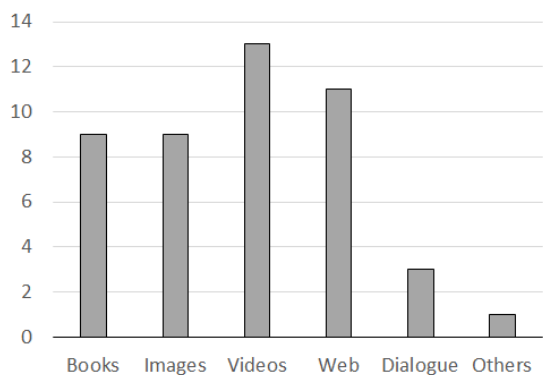

Figure 1. Results for Q1. Which types of media are most effective in learning about experts' creation processes? (N=14, multiple answers allowed)

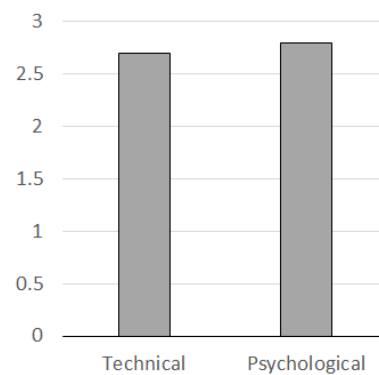

Figure 2. Average results for Q2. What is your level of interest in the technical/psychological aspects of experts' creation processes? (N=14)

3.2 Observation of Experts' Design Processes by Students

Based on the result of the questionnaire survey, a user study was conducted with the aim of revealing how learners observe experts' design processes. As a learning material, we used two video clips from a documentary film on the drawing processes of a famous manga artist, Inoue Takehiko (Inoue, 2006). The details of the videos are described as V1, V2 and typical behaviors considered as part of the reflection process are listed as R1, R2 and R3 in Table 2. The students were asked to report their awareness of the expert's technical and psychological aspects through watching the videos.

R2 was clearly regarded as a reflection-on-action process because the expert declared it to be so; however, it is not obvious that R1 and R3 are reflection processes because the artist did not mention them. R1 is likely to be reflection-in-action process, and R2 is unequivocally a reflection-on-action process.

As a result of the observation, the students reported their levels of awareness: 42.9%, 28.6% and 85.7% of the students mentioned R1, R2 and R3, respectively.

Table 2: Videos for the observation

V1	A documentary film focusing on Inoue's hand, which draws scenes from a very famous manga comic, <i>Vagabond</i> . 38 min.	
	R1	The expert said "Hmm..." while he was drawing the face of a character.
V2	A video that shows the drawing processes of other scenes from the same comic as that shown in V1. This includes dialogues between Inoue and an interviewer. 55 min.	
	R2	The expert reversed a sheet of paper in order to examine whether the body of a character is balanced well.
	R3	The expert corrected the eyes of a character using correction fluid.

4. Reflection-in-/on-Action in Experts' Design Processes

4.1 Analysis of Results using the Retrospective Think Aloud Protocol

Since the target videos used for the preliminary study were in the commercial DVD (Inoue, 2006), the reflection processes were not immediately obvious. For the purpose of linking some of the artist's behaviors with reflections, an audio commentary of another expert's design process was recorded, along with eye-tracking data. The expert is a professional designer and also a part-time lecturer at several colleges. His work centers on logos, typefaces, posters, flyers, and so on. For this experiment, the artist was instructed to create a logo as part of a real logo design competition for a botanical garden in Japan. The tools he selected were Adobe Illustrator, Adobe Bridge, and Google Chrome. In order to track his eye movements, Tobii X2-30 Eye Tracker was used. This device can record eye-movement data without goggles. Figure 3 shows an image of the recording session.

The design process by the expert was initially recorded using his eye-tracking data (Figure 4 shows a screenshot of this data). The design was finished in three hours.

After the design process was complete, an audio commentary for the video containing the eye-tracking data was recorded through the Retrospective Think Aloud Protocol (Guan et al. 2006). Table 3 provides details on this video, and the behaviors that correspond to the reflection processes mentioned by the expert.



Figure 3. The environment during recording of the expert's design process



Figure 4. Eye-tracking data, which indicates that the expert was paying close attention to the character spacing

Table 3: Details on the audio commentary video and mentions of the reflection process

V3	An audio commentary video that includes eye-tracking data on designing a logo for a botanical garden in Japan. 170 min.	
	R4	The expert fine-tuned the position of the kanji characters using the arrow keys on the keyboard.
	R5	The expert fine-tuned the size of the leaves using the arrow keys on the keyboard.
	R6	The expert compared several logos made with different fonts.
	R7	The expert zoomed out and considered the logo for a while.

The reflection processes listed in Table 3 are all recognized as reflection activities by the expert. R4 and R5 can be regarded as reflection-in-action processes, because the expert was reflecting while taking the action (i.e. fine-tuning using the arrow keys). On the other hand, R6 and R7 are reflection-on-action processes, because the artist was reflecting on the results of the previous action.

In addition to this awareness of reflections, the expert was surprised at his behavior because while he was adjusting the characters (R4) he paid close attention to the character spacing (Figure 4). This shows that even the expert himself could learn from his own design process. In other words, he “reflected on reflection-in-action”.

4.2 Observation of Expert’s Design Process by Students

In order to examine whether the college students were able to understand or learn about the expert’s creation processes by just watching the audio commentary, an observation was conducted with the same student participants as in Section 3.

In focusing on the reflection processes, R4 and R5 did not capture the student’s attention to the same degree as R6 and R7, which were recognized as meaningful behaviors by the expert. Only one student (7.1%) had some awareness of R4, and stated, “This manipulation is a delicate adjustment”. A total of 14.3% of the students mentioned R5, for instance: “The expert is continuing to look for a satisfying size”; “it is not so easy for me to understand the slight differences...”. In addition, 35.7% of the students showed some interest in the expert’s comparison of several fonts (R6), stating, for example, “I cannot decide which is the best”; “Comparing a lot of fonts makes me confused...”; “This font is better”; and so on. R7 was recognized as a meaningful behavior by 28.6% of the students. Several comments, such as “I think that he is checking the arrangement”; and “Zooming in and out is important!” were received.

5. Conclusion and Future work

This paper describes experts' reflection-in-/on-action processes in design, and how learners observe this from video data. Since the number of participants in these studies was small, the results from the quantitative data were limited; however, we discovered a new perspective from the students' written comments.

The findings from the observations and analysis are as follows:

- College students majoring in media design have an interest in both the technical and psychological aspects of the creative design process.
- Videos are preferred as learning materials related to the design process.
- Behaviors related to reflection-in-/on-action were observed through the experts' design process.
- Reflection-on-action processes are relatively recognizable, whereas reflection-in-action processes are not.

How, then, can students learn about design processes used by experts? One key element is "reflection on reflection-in-/on-action," as described in Section 4.1. Giving some cues that indicate instances of reflection-in-/on-action during recorded design process would be useful in this regard, as would providing cues to indicate instances in which the expert is reflecting on their reflection processes. The fact that even experts continue to reflect on their behavior should enhance learners' interest in the reflection processes.

Acknowledgements

The author would like to thank Hirohisa Motoyama for participating this study as an expert designer, and for giving helpful suggestions. This work was supported by MEXT KAKENHI Grant Number 24501218.

References

- Guan, Z., Lee, L., Cuddihy, E., and Ramey, J. (2006). The validity of the stimulated retrospective think-aloud method as measured by eye tracking. R. Grinter, T. Rodden, P. Aoki, E. Cutrell, R. Jeffries, and G. Olson (Eds), *Proceedings of CHI '06* (pp. 1253-1262). NY, ACM.
- Inoue, T. (Manga Artist), Okuwa, Y. (Producer) (2006). DRAW [DVD]. Tokyo: I.T. PLANNING, Inc.
- Nakakoji, K., Yamamoto, Y., Takada, S., and Reeves, B.N. (2000). Two-dimensional spatial positioning as a means for reflection in design. D. Boyarski, and W. A. Kellogg (Eds), *Proceedings of DIS '00* (pp. 145-154). NY, ACM.
- Schoen, D.A. (1983). *The Reflective Practitioner: How Professionals Think in Action*. NY, Basic Books.

A Relationship between the Pair Effect and the Learner Characteristic at Pair Work in Computer Literacy Education

Kimiko UCHIDA^{a*}, Yoshihiko OYA^b & Takashi OKUDA^c

^a Nagoya University of Arts and Sciences Junior College, Aichi Prefectural University, Japan

^b Nagoya University of Foreign Studies, Japan

^c Aichi Prefectural University, Japan

* uchida@nuas-jc.ac.jp

Abstract: We have introduced pair works to university-level computer literacy education as opposed to the traditional one, standalone teaching. In this paper, in order to extract the learner characteristics factors that influence the pair work effects such as test-score improvement level, pair-work activity level and pair-work satisfaction level, we conducted two experimental pair work classes in computer literacy exercise courses. For the investigation, we used two main questionnaire surveys, TEG II and GAMI as personality indexes. The result showed that the personality index has clear strong correlation with the degree of activity and degree of satisfaction in TEG II and also to the degree of score elevation in GAMI. The personality score, obtained from the result, is useful for more effective pair combination.

Keywords: Computer literacy education, pair work, pair combination, personality

1. Research Background and Objective

Following the global educational trends of recent years, active learning, wherein students discover a problem and attempt to find a solution on their own, has been increasingly required. To implement active learning, gaining and increasing information literacy, which serve as the basis of information collection and transmission, are also necessary. To address these issues, we implemented lessons for university freshmen, incorporating pair work into information literacy education, and confirmed its effectiveness. Subsequently, we concluded that pair work can be very effective for the education.

For effective pair work, the method of forming pairs is important and fundamental. In many cases, however, pairs are determined randomly, e.g., according to the order of students' ID numbers or seating arrangement. Moreover, research specializing in pair formation is almost nonexistent.

Hence, since 2008, we have continued a survey to establish a pair formation method that optimizes student combinations. Thus far, we have clarified the following: 1) Problem solving by a pair exceeds that by an individual, and pair achievement is generally significantly higher than individual achievement; 2) the most effective pair combinations included those with a small difference in basic scholarship, and mixed gender (Uchida and Oya, 2011). However, our experience also shows that the personality of student must influence the pair effect.

Thus, this paper focuses on the personality traits that have been reported to affect cooperative learning and aims to improve the pair-work effectiveness by devising pair combinations according to quantitative scale scores.

2. Personality and Pair Effect

We investigated the learning motivation closely related to the class and the personality traits according to eograms, effective in diagnosing tendencies of interpersonal communication.

Used to measure personality traits, the eogram is widely used in the medical field, but also in education—to examine university curriculum that considers students' characteristics and their awareness of information morals. There are many types of eogram. In this study, TEG II (Tokyo

University Psychosomatic Medicine TEG Association, 2006), widely and generally used, was administered. To measure learning motivation, we used GAMI (the Gakugei Academic Motivation Inventory, Shimoyama, 1985), a widely used scale with criteria for classifying learners' characteristics. To develop e-learning materials suitable for different learning motivation types, relevance verification of learning motivation, and Internet usage, GAMI is a psychological scale that standardizes learning motivation measurement.

For the pair effect, we used three values: 1) test-score improvement level, 2) pair-work activity and 3) pair-work satisfaction level. The test-score improvement level represents the extent of increase or decrease in the score deviation value of the pair test, compared with the individual test deviation value. To measure pair-work activity, we used the number of utterances during pair work. Because, the amount of utterance is effective in the state estimation of cooperation working. Furthermore, the students' satisfaction level will be considered as an important factor for effective pair work. The post-questionnaire measured two values for satisfaction level: the overall pair work satisfaction level and the pair-combination satisfaction level.

3. Method

In 2013, we conducted experimental classes using pair work. The participants were approximately 160 students participating in computer literacy courses in four classes at two private universities in Japan. In April, we conducted a preliminary survey on the pair combination indicators which are basic academic ability and gender. Following nine computer literacy lessons based on a simultaneous method, an individual test was conducted to calculate the pair effect. Our experimental pair work classes were conducted once a week for two weeks in June. Each pair comprised a male and female with similar academic abilities, which was confirmed to have a significant impact by a previous study. In the first pair work test (Test 1), a 15-minute practical test based on the word processing qualification examination was conducted. At the same time we conducted a 10-minute survey of personality (TEG II). In the second test (Test 2), a 25-minute assignment to create a sample document for a display poster and a 10-minute survey of personality (GAMI) were allocated. Before the pair work, a 5-minute free talk period was provided to develop smooth conversations between pair members who were meeting for the first time. We recorded the exchanges from the free talk to the end of the pair work with an IC recorder. After the pair work, we conducted a 21-item questionnaire survey on problem solving in pairs.

The procedure of analysis is as follows: First, we performed a basic analysis of the pair effect from test-score improvement level and activity level of Test 1 and Test 2, results of the overall pair work, and the pair-combination satisfaction level. Next, we attempted to find the correlation coefficients among TEG II and GAMI, the test-score improvement level, activity, and satisfaction level in an effort to select the elements involved in the pair effect from the significance probability.

4. Personality Score and Estimation

To examine whether a relationship exists between TEG II, GAMI and the pair effect, we analyzed its correlation with the result test-score improvement level, activity, and satisfaction level. The result showed that the personality's characteristics has clear strong correlation with the degree of activity and degree of satisfaction in TEG II and also to the degree of score elevation in GAMI.

On the basis of these results, we summarized the scales of GAMI and TEG II that show relationships with the test-score improvement level, pair-work activity, and pair-work satisfaction level (see Table 1). A single asterisk (*) refers to points with 5% significance and a double asterisk (**) refers to points with 1% significance. There is a clear strong correlation between five items of GAMI regarding the test-score improvement level, four items of TEG II and two items of GAMI regarding activity, and four items of TEG II and seven items of GAMI regarding satisfaction level. From these results, we believe each effect of pair work—mixed gender with small basic academic ability difference—could be improved by devising pair formation using TEG II and GAMI.

Then, we proposed a pair formation improvement method using the values obtained from TEG II and GAMI: First, on the basis of these results, we calculated the individual personality score (PS) using the scale scores of GAMI and TEG II. Next, we divided the students into three groups, L, M, and H, using the quartile method. Then, the LL pair with the personality trait of low mutual pair effect was

Table 1: Relevance between personality factors and each pair effect.

	test-score improvement level		pair-work activity level		pair-work satisfaction level	
	Test1	Test2	Test1	Test2	pair work	pair-combination
TEG II						
①CP(Critical Parent)	-.057	-.092	.113	.156	.221 **	.193 *
②NP(Nurturing Parent)	-.118	-.121	.149	.278 **	.375 **	.161 *
③A(Adult)	.054	.067	-.181 *	-.178 *	-.047	-.017
④FC(Free Child)	.021	-.034	.166 *	.263 **	.353	.176 *
⑤AC(Adapted Child)	.018	.008	-.169 *	-.136	-.128 **	-.003
GAMI						
①Voluntary learning attitude	-.224 **	-.261 **	.134	.017	.073	.202 **
②Achievement-oriented attitude	-.034	-.042	-.036	.062	.287 **	.158 *
③Sense of responsibility	-.113	-.189 *	.194 *	.219 **	.303 **	.240 **
④Amenability	-.118	-.140	-.055	.013	.298 **	.182 *
⑤Self-assessment	-.208 **	-.162 *	.100	.095	.228 **	.037
⑥Tendency to avoid failure	-.001	-.002	-.084	.004	-.074	-.189 *
⑦Lack of persistency	.150	.230 **	-.097	-.055	-.138	-.175 *
⑧Lack of learning values	.285 **	.282 **	-.177 *	-.106	.006	-.149

** p<.01 * p<.05

extracted, after which we swapped partners in order for them to be paired with those having personality traits with high mutual pair effect. In addition, we also tried to evaluate this change’s possibility by simulating the effect when rearranging the pair using PS.

Using the TEG II and GAMI scale scores, we examined various formulas for the PS calculation method. Finally, we decided to use the formula in which the total number of asterisks in the Table 1 was multiplied by each scale score presents normality.

In order to verify the effect of the pair combination using PS which we propose, we performed the experiment class for verification from June to July in 2014. We rearranged the partner of the pair with low PS (LL pair) and compared the pair effect of a recombination groups and non-groups. As a result, the value of the group which rearranged the degree of results rise, the test-score improvement level, the pair-work activity level and the pair-work satisfaction level became high.

In conclusion, it became clear that the pair combination method using PS raises the pair effect of the whole class work.

5. Summary

Pair work using the pair combination indicators was introduced in the information literacy course. We mainly examined the learners’ personalities as it is a major factor impacting pair effect. We clarified that personality traits extracted by TEG II and GAMI are strongly involved in the test-score improvement level, activity, and satisfaction level. Therefore, it is suggested that even in pair formation, we can improve the effectiveness of indicators by incorporating some TEG II and GAMI items in addition to the two confirmed ones (gender and basic academic ability difference). Moreover, we performed a pair rearrangement using PS calculated in this study. Test-score improvement level, activity, and satisfaction level were simulated. As a result, the class’s overall pair-effect level improved through elimination of pairs in which both personalities were with low effect.

The investigation in 2014 shows that this method improves the class’s overall pair effect level.

Acknowledgements

This study received financial support from 2012 scientific research grants and a Grant-in-Aid© for Scientific Research (Issue Number: 24501231).

References

- Shimoyama, T. (1985). *Perception and derivation of motivation for learning*, Tokyo, Kyoiku Shuppan.
 Tokyo University Psychosomatic Medicine TEG Association (2006). *New edition TEG II: manual and Egogram pattern*, Tokyo, Kaneko-Shobo.
 Uchida, K. and Oya, Y. (2011). Practical Consideration about Obstructive Factors at Paired Learning in Computer Literacy Education. *Japan Jour. Educational Technology*, 35, 100-103.

A Study on Teaching Debugging Strategies for Digital Circuit

Hong-Fa Ho^{a*} & Duen-Huang Huang^b

^a*Department of Electrical Engineering, National Taiwan Normal University, Taiwan (R.O.C.)*

^b*Department of Industrial Education, National Taiwan Normal University, Taiwan (R.O.C.)*

*jackho@ntnu.edu.tw

Abstract: It is essential for educators to identify the student's reading ability when learning debugging strategies. Forty-five senior high school students (average 17.6 years old, $SD=0.35$) participated in this study. The participants were divided into three groups to examine the effect of three teaching materials including 1) normal reasoning, 2) a debugging process model, and 3) a debugging process model and three debugging strategies, namely, forward strategy, backward strategy, and CLOCK-based strategy. While the participants debugging a digital circuit question, the eye tracker recorded the eye movement data for analysis. The results indicated that participants receiving a debugging process model and three debugging strategies improved their debugging skills significantly by: 1) increased percentage of the participants finding bugs correctly, 2) increased percentage of the participants using debugging strategies correctly, and 3) reduced time spent on debugging in average. The findings may help educators and researchers understand the benefit of debugging strategies on digital circuits to design better teaching materials, methods, and learning strategies.

Keywords: Digital logic circuit, timing diagram, debugging strategy, reading process, eye movement data

1. Introduction

Digital circuit, especially digital integrated circuit is one important electronic product. Engineers design and test digital circuit functions using software development tools such as tools for FPGA, ASIC, and CPLD. Debugging is a term to describe the engineers identifying system errors by observing a simulation software or logic analyzer. Since debugging is inevitable in system development process and required repetitive checks, one of the key capabilities of electronics engineers is to read digital circuits and timing diagrams efficiently and strategically. However, there is a lack of complete textbooks introducing debugging strategies on digital and integrated circuits. The authors identified three consistent debugging strategies based on most practices electronics theories including: 1) forward (from inputs to outputs), 2) backward (from outputs to inputs), and 3) CLOCK-based. By using eye tracker, the purpose of this study is to understand students' debugging processes and the influence of three strategies on students' debugging capability.

2. Literature review

Many research findings have identified the importance in understanding domain knowledge (Dochy, Segers, & Buehl, 1999), reading technology (Voss & Silfies, 1996), and reading strategies (Cottrell & McNamara, 2002) for general scientific knowledge. However, reading strategies on digital circuits and timing diagrams are rarely discussed and limited training are provided for engineers.

Araki, Furukawa, and Cheng (1991) proposed a theory of debugging process model, which is a repeat procedure including initial hypothesis, hypothesis modification, hypothesis selection, hypothesis verification, and inspection process on correct bug finding. Initial hypothesis refers to an aspect of error report. If there is no error report, the engineers need to find out where the error is in order to continue the

initial hypothesis. Xu and Rajlich (2004) explained the cognitive process of knowledge, comprehension, application, analysis, synthesis, and evaluation in program debugging. The eye reading scan path recorded by eye trackers as objective evidence can examine the initial hypothesis on correct bug finding related to Bloom's six cognitive categories.

3. Research framework and process

Teaching materials and test materials were designed based on the debugging process model and three types of debugging strategies: forward strategy, backward strategy, and CLOCK based strategy (four subtypes of CLOCK triggering including high-level, low-level, positive-edge, and negative-edge). Before the experiment, the study provided readily available prior knowledge resources based on the needs of learners to avoid the sample bias on various prior knowledge and memory among participants. The detail research framework is shown in Figure 1; the participants followed the experimental procedures by pre-test, course modification, and post-test. The complete interactions were recorded in the computer eye tracker for research analysis.

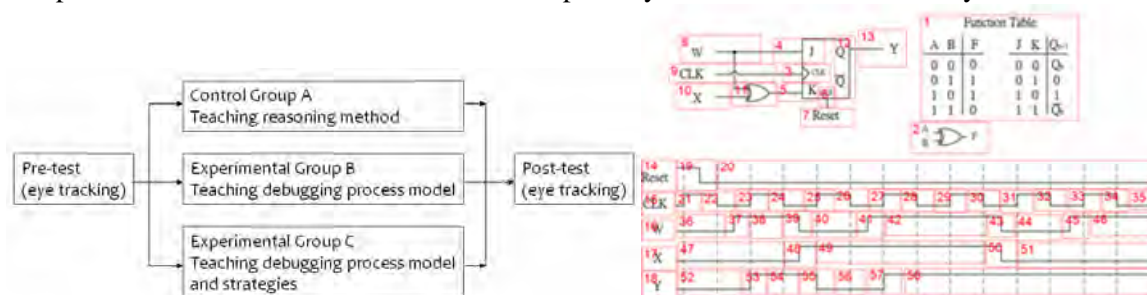

Figure 1. Research framework and process. Figure 2. Defined ROIs on the digital logic circuit.

To explore the different debugging strategies taught by the same instructor on the effect of debugging capabilities among the participants, following research method was conducted.

4. Method

4.1 Participants and Materials

Participants were volunteered from HsinChu Kuang-Fu high school; all participants had experience, and gained credit points in digital circuits. A total number of 45 senior students (average 17.6 years old, $SD=0.35$) received parental consent to participate in this study. The participants were divided into groups based on the original classes they were attending: $N_A=15$, $N_B=14$, $N_C=16$. The participants had normal or corrected eyesight.

Test Materials: each participant undertook four eye tracking experiments including two pre-test and two post-test questions on digital logic circuit (J-K flip-flop), timing diagram (with one bug), and function table. Three teaching materials included: 1) normal reasoning, 2) a debugging process model, and 3) a debugging process model and three debugging strategies named forward, backward, and CLOCK-based strategy. CLOCK-based strategy has four subtypes relating to digital circuits CLOCK trigger models including high-level, low-level, positive-edge, and negative-edge triggering.

4.2 Design, Procedure, Instrument, and Data Analysis

This study is a 3x9 factorial quasi-experimental design comprised of three major experimental steps including pre-test, course modification (by the same instructor), and post-test. Independent variables included teaching materials (A: normal reasoning, B: debugging process model, C: debugging process model and debugging strategies), and Region of interest (ROI in short)(nine ROIs shown in Figure 2). Dependent variables included 1) the number of bugs found

correctly, 2) the number of times participants used debugging strategies been taught, 3) average time-spent in finding bugs correctly, and 4) eye movement variables (including scan paths and LCS of scan paths). The procedure is shown in Figure 1. EyeNTNU-180 eye tracker presented with a collection of experimental stimuli and record information on the participant's eye movements.

The average percentages of finding correct bugs were calculated based on participants' answers. Because the large eye movement data output from the eye tracker, the manual analysis became difficult to determine if the scan path contain equivalent eye movement data when the participant utilizing debugging strategies. The longest common subsequence (LCS) algorithm (Bergroth, Hakonen, & Raita, 2000) was then used to determine the scan path if a participant used the debugging strategies.

5. Results

Results of the analysis are shown in Table 1.

Table 1: Results on participants correctly debug digital circuit questions.

		Control group A ($N_A=15$)	Experimental group B ($N_B=14$)	Experimental group C ($N_C=16$)
Pre-test	# of Found bugs	16.67%	13.33%	16.67%
	Used debugging strategies	3.33%	3.33%	3.33%
	Average time-spent	236sec	277sec	244sec
Post-test	# of Found bugs	13.33%	26.67%	36.67%
	Used debugging strategies	3.33%	10.00%	60.00%
	Average time-spent	242sec	182sec	113sec

6. Findings and Implications

The results showed participants undertaking classes of debugging process model and debugging strategies had significant improvement in debugging ability and performance by: 1) increased percentage of the participants finding bugs correctly, 2) increased percentage of the participants using debugging strategies correctly, and 3) reduced time spent on debugging in average. The proven effectiveness of the debugging strategies will support and further to develop teaching software in electronic strategies.

Acknowledgements

This research is partially supported by the "Aim for the Top University Project" of National Taiwan Normal University (NTNU), sponsored by the Ministry of Education, Taiwan, R.O.C. and the "International Research-Intensive Center of Excellence Program" of NTNU and National Science Council, Taiwan, R.O.C. under Grant no. NSC 103-2911-I-003-301.

References

- Araki, K., Furukawa, Z., & Cheng, J. (1991). A general framework for debugging. *Software, IEEE*, 8(3), 14-20.
- Bergroth, L., Hakonen, H., & Raita, T. (2000). *A survey of longest common subsequence algorithms*. Paper presented at the String Processing and Information Retrieval, 2000. SPIRE 2000. Proceedings. Seventh International Symposium on, A Curuna.
- Cottrell, K., & McNamara, D. S. (2002). *Cognitive precursors to science comprehension*. Paper presented at the Proceedings of the Twenty-fourth Annual Meeting of the Cognitive Science Society, Fairfax Virginia, USA.
- Dochy, F., Segers, M., & Buehl, M. M. (1999). The relation between assessment practices and outcomes of studies: The case of research on prior knowledge. *Review of educational research*, 69(2), 145-186.
- Voss, J. F., & Silfies, L. N. (1996). Learning from history text: The interaction of knowledge and comprehension skill with text structure. *Cognition and Instruction*, 14(1), 45-68.
- Xu, S., & Rajlich, V. (2004). *Cognitive process during program debugging*. Paper presented at the Proceedings of the Third IEEE International Conference on Cognitive Informatics

Design of Embodied Learning in 3D Virtual Worlds for Pre-service Teachers

Young Hoan CHO^{a*}, Yoon Kang KIM^a, Myung-Seop KIM^a & Mae Hyang HWANG^b

^a*Department of Education, Seoul National University, South Korea*

^b*Department of Education, Gyeongin National University of Education, South Korea*

*yhcho95@snu.ac.kr

Abstract: This study intended to design embodied learning in 3D virtual worlds (ELVW) for the development of real-world problem solving competencies. The strengths and weaknesses of the ELVW model were explored in pre-service teacher education in South Korea. Through ELVW, elementary school pre-service teachers (n = 35) significantly improved their self-efficacy in preventing and addressing school-bullying behaviors. From interviews, this study identified strengths of ELVW in pertaining to embodied experience, collaborative learning, and instructional supports. To improve the ELVW practice, more efforts are needed to overcome technical and time constraints and to investigate the role of embodied experience in the 3D virtual world.

Keywords: Virtual world, embodied cognition, collaborative learning, teacher education

1. Introduction

Literature of embodied cognition has revealed that the body, which dynamically interacts with the physical world, plays a crucial role for knowledge construction and reasoning (Black, Segal, Vitale, & Fadjo, 2012). Embodied learning can occur not only through direct interaction with the physical world but also through an avatar, which represents a learner, in 3D virtual worlds (i.e., augmented embodiment; Black et al., 2012). The embodied experience and interaction, which are crucial for physical and social presence, have been considered as key affordances of virtual worlds (Dalgarno & Lee, 2010). The current study aims to develop the model of embodied learning in 3D virtual worlds (ELVW) for improving real-world problem solving competencies of pre-service teachers. Particularly, this study is interested in the development of classroom management competencies in pertaining to school bullying, which is a serious problem in South Korea. The research questions of this study are as follows:

- What are the strengths of ELVW for improving real-world problem solving competencies of elementary school pre-service teachers?
- What are the limitations of ELVW in the context of Korean pre-service teacher education?

2. Embodied Learning in 3D Virtual Worlds

The ELVW model is designed to improve real-world problem solving competencies in complex and ill-structured domains. Particularly, this model can be beneficial for learners who do not have enough opportunities for learning by doing in the physical world. Through ELVW, learners can use their perceptual and embodied experience in 3D virtual worlds for developing an in-depth understanding of a complex problem situation and collaborative problem solving skills. Although a small number of studies presented instructional models based on embodied cognition (e.g., Han & Black, 2011), little attention is paid to embodied learning in complex and ill-structured domains. Based on literature of embodied cognition, problem-based learning, and collaborative learning, this study created the ELVW

model that fosters real-world problem solving competencies through learning by doing in the virtual world (see Figure 1).

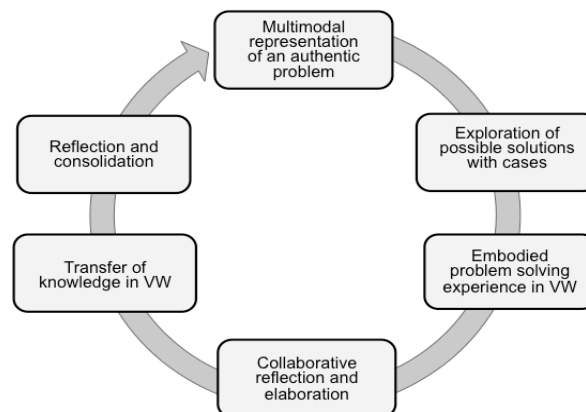

Figure 1. Model of embodied learning in a 3D virtual world (VW)

The ELVW model consists of collaborative problem solving and reflection activities in blended learning environments. The ELVW activities are developed and implemented on the basis of the following design principles:

- Real-world problems are presented with multimedia that support multimodal representations.
- Multiple cases (or perspectives) are compared and contrasted to support problem solving.
- Learners collaboratively create and evaluate solutions through argumentative discourse.
- Learners solve real-world problems through embodied experience in the virtual world.
- Learners have autonomy in interacting with the virtual world through avatars.
- Virtual world enables learners to express their ideas in both verbal and nonverbal ways.
- Embodied experience should be followed by reflection and consolidation activities.
- Instructor should provide appropriate instructional supports when they are necessary.
- Learners are encouraged to transfer their knowledge to different problem situations.

3. Methods

In the study, 35 (11 male and 24 female) elementary school pre-service teachers participated as part of the school-counseling course in South Korea. According to the ELVW model in Figure 1, participants had collaboratively solved a school-bullying problem in blended learning environments for four weeks. They discussed a real-world problem, conducted a role-play (i.e., embodied problem solving), and reflected on their embodied experience at a 3D virtual classroom in Second Life (see Figure 2). Instructional supports including scaffolding and feedback were mainly provided in a classroom.



Figure 2. Avatars in a 3D virtual classroom

The survey of self-efficacy (Cronbach's $\alpha=.93$) in preventing and addressing school-bullying behaviors was conducted before and after the ELVW activities. In addition, the survey of perceived achievement (Cronbach's $\alpha=.91$) was implemented right after the ELVW activities. The surveys used a five-point Likert scale. In addition, 10 participants were interviewed in terms of strengths and

weaknesses of ELVW. The grounded theory approach was applied to analyzing interview data through constant comparison and discussion among three researchers.

4. Findings

This study found a positive influence of ELVW for self-efficacy about school bullying. A paired sample t-test showed that pre-service teachers' self-efficacy significantly improved through the ELVW activities ($M = 2.84$ vs. 3.58), $t(34) = 4.74$, $p < .001$. Their perceived achievement was somewhat positive ($M = 3.4$, $SD = .75$). Consistently, the interview analysis revealed more strengths than weaknesses, which were mainly related to technical problems and time constraints. The strengths of ELVW were summarized as follows:

- Verbal and non-verbal communication through avatars contributed to the presence and situational interest of pre-service teachers in the virtual world.
- Embodied experience in the virtual world helped pre-service teachers to take diverse perspectives of stakeholders in a school-bullying problem.
- Collaboration with group members encouraged active participation.
- Success and failure cases of experienced teachers were helpful in understanding a problem situation and exploring possible solutions.
- Collaborative reflection was helpful for making sense of embodied experience in the virtual world.
- Pre-service teachers had sufficient autonomy in deciding their activities in the virtual world.

The strengths above were closely related to the pedagogical principles of the ELVW model. This study also identified the weaknesses of ELVW as follows:

- Due to the Internet speed, pre-service teachers had difficulty in interacting with others through avatars in the virtual world.
- Pre-service teachers did not have enough time to carry out a role-play in the virtual world.
- Verbal and non-verbal communication should be enhanced for more natural interaction in the virtual world.

5. Conclusion

The current study designed the ELVW model based on the literature of embodied cognition, problem-based learning, and collaborative learning. In teacher education, this study found that the ELVW activities significantly improved pre-service teachers' self-efficacy in preventing and addressing school-bullying behaviors. In addition, this study found a few strengths of ELVW in pertaining to embodied experience in the virtual world, collaborative problem solving and reflection, and appropriate instructional supports (e.g., success and failure cases, autonomy support). To improve the ELVW activities, future research is recommended to prevent technical problems and time constraints and to enhance verbal and non-verbal communication with advanced technologies (e.g., motion sensing input devices). In addition, more attention should be paid to the role of augmented embodiment in the virtual world for learning process and outcomes.

References

- Black, J. B., Segal, A., Vitale, J., & Fadjo, C. L. (2012). Embodied cognition and learning environment design. In D. Jonassen & S. Land (Eds.), *Theoretical foundations of learning environments* (2nd Edition, pp. 198-223). Florence, KY: Routledge.
- Dalgarno, B., & Lee, M. J. W. (2010). What are the learning affordances of 3-D virtual environments? *British Journal of Educational Technology*, *41*(1), 10-32.
- Han, I., & Black, J. B. (2011). Incorporating haptic feedback in simulation for learning physics. *Computers & Education*, *57*, 2281-2290.

Development of Predict-Test-Revise Modeling Abilities via a self-study Learning Environment

ANURA KENKRE*, SAHANA MURTHY & MADHURI MAVINKURVE

Inter-Disciplinary Program in Educational Technology, Indian Institute of Technology Bombay, India

*anura.kenkre@iitb.ac.in

Abstract: In addition to developing students' content knowledge, an important goal of science instruction is to improve students' ability of modeling, such as, the ability to create and use simplified representations to describe and explain phenomena, and predict outcomes of new phenomena. It has been shown that students face difficulty in developing these abilities unless they are explicitly addressed in the curriculum. ICT-based solutions to this problem have been developed, such as the WISE and MARS, have mostly been implemented at the middle and high school levels and the teacher facilitates the process. In this paper we describe the design of LEMA, which addresses modeling abilities in college level science topics. LEMA is a self-regulated learning environment in which students are given various activities and customized formative assessment to achieve the above goals. We tested the effectiveness of LEMA through a two-group post-test controlled experiment. Students who learnt with LEMA performed significantly better on abilities of prediction, testing and revision of models. We also identified student perceptions of which features of LEMA helped them develop these abilities.

Keywords: predict-test-revise abilities, modeling, learning environment, self study

1. Introduction & Related Work

The goal of traditional classroom instruction in science and engineering has typically been that students develop certain other science *process-related* abilities in addition to their content knowledge. One such ability is that of modeling which refers to the use of models or simplifications to create faithful representations of the processes of science by providing satisfactory explanations of the phenomena in the world as experienced and predict outcomes of new phenomena (Gilbert, 2004). Studies have shown that under traditional instruction, students have difficulty in understanding and using models (Gilbert, 2004), especially in the understanding the predictive nature of models (Grosslight, et.al., 1991). There have been instructional interventions such as WISE (Linn & Slotta, 2000; Linn & Hsi, 2000), MARS (Raghavan, et.al., 1993; Raghavan & Glaser, 1995) and ISLE curriculum (Etkina & Van Heuvelen, 2007) which are two week to a semester long interventions which integrate a computer supported environment with classroom activities and have succeeded in developing students understanding about the interpretive and predictive nature of models. But in all these methods, the teacher plays an important role by facilitating the process, giving prompts or grading the student's efforts at a later stage (Raghavan & Glaser, 1995; Treagust, et.al, 2002; Verschaffel & De Corte, 1997) and these curricula have been implemented mostly at the middle school and high school levels, and to some extent in introductory college courses. In this paper, we introduce the rationale for the design of a Learning Environment for Modeling Education (LEMA) which is an ICT-based solution made specifically for the context of self study wherein each topic has a learn time of 45-60 minutes. We have performed a two-group quasi-experimental study to determine whether LEMA helps students in developing abilities of using models, prediction, testing and revision. Students' perceptions using reflection questions were used to ensure that LEMA features are consistent with our design rationale for including these features.

Students make sense of the world around them, and what they are taught, by means of conceptual models that they form in their minds. If these models are incorrect, it leads to flawed reasoning and misconceptions (Gilbert, 2004). An important aspect of modeling is to explain the macroscopic outcome of a given situation by applying a model at a microscopic level. Research shows that students have difficulty transferring from a macroscopic level of representation to the microscopic level (Gabel, 1998). Multimedia tools such as animations and simulations, which help students connect

between these levels, have been shown to promote conceptual understanding (Kozma et. al., 1997). However, in order for students to be able to learn in the absence of a teacher or facilitator, the process of self-regulated learning has been recommended. Formative assessment in the form of rich and timely feedback, along with the opportunity to revise responses, has been shown to support the development of learner self regulation (Nicol & Macfarlane-Dick, 2006) and research has shown that question prompts can facilitate explanation construction (Bereiter & Bird, 1985), monitoring and evaluation (Davis, 2000), and making justifications (Lin & Lehman, 1999).

2. Design of the Learning Environment for Modeling Education (LEMA)

The process of designing LEMA included identifying specific modeling abilities to target, identifying learning objectives, determining the features to be included and creating the instructional design. The modeling abilities were adapted from the scientific abilities rubrics (Etkina, et.al., 2006).

We define ‘Modeling ability’ as a measurable set of abilities in which students learn to make predictions, test predictions with respect to experimental results, and revise predictions if necessary. In the prediction phase, students should be able to devise an explanation for an observed pattern, make a reasonable prediction based on explanation. In the testing phase, students should be able to decide whether the prediction and the outcome agree/disagree. And in the revision phase, students should be able to revise the explanation when necessary.

LEMA was designed using features suggested for the development of students scientific abilities such as ‘learning material should allow students to explain reasoning, justify conclusions, analyze outcomes of an experiment, get immediate feedback, after sharing their explanations students design testing experiments to determine if their explanations work’ (Etkina, et.al., 2006). On the basis of all these features an Instructional Design Document was created and was given to two subject matter experts for content validity. Fig 1 given below shows a screen shot of the important features of LEMA. Left to Right- Simulation of the Microscopic Model, Prediction Questions, Justification Box, Experimental Results for comparison and judgement and Assertion and Reasoning based questions with customized feedback.



Figure.1—Screenshot of the features of LEMA

In the Simulation of the microscopic model, students are asked to interact with it with the help of variable manipulation, text entry and meter readings. This feature helps in developing all the abilities of modeling, namely the ability to make observations, predictions, testing predictions and revising them. This is done because it is said that features such as isolation and manipulation of parameters helps students to develop an understanding of the relationships between physical concepts, variables and phenomena (Lee, et.al., 2002). In the feature of prediction questions, students are given a macroscopic situation and are asked to use the microscopic model in order to predict what might be the outcome of this situation. This feature helps in developing the sub ability of making a reasonable prediction based on explanation in the prediction phase. This is important because any learning material should provide opportunity for predicting the outcome of a situation/experiment (Gilbert,2004). When students have predicted the outcome of any situation, they are asked to write explanation on which the prediction is based. This feature helps in developing the sub ability of devising an explanation for an observed pattern and making a reasonable prediction based on explanation. This is needed because students should be able to adapt a known model to the specifications of the given problem (Wells, et.al., 1995) During the test phase, students are provided with real world answers and hints and are asked to decide whether the prediction and the outcome agree/disagree in the testing phase. This is important because students should be able to analyze the outcomes of an experiment and be able to justify your conclusions (Wells, et.al., 1995). During the revise phase, students are shown their prediction and justification of the IV graph of the PN junction and they are asked to answer questions aligned with IV

graph chosen by them. If they are getting the answers incorrect, then they are given feedback which helps them identify what was missed by them in their observations are asked to note that particular aspect in the simulation. This is a very crucial feature because designing instruction using building blocks such as hint, if-confused and summarization is much more powerful than designing instruction at the level of show video. (Linn, et.al., 2000; Wielinga, et.al., 1992). In order to summarize LEMA, students are shown the working of the microscopic model of the PN junction, the experimental set up with meter reading and a graphical plot of the IV characteristics dynamically. This is done because employing a variety of representations (pictures, animation, graphs, vectors and numerical data displays) is helpful in understanding the underlying concepts, relations and processes (Robinson, 1987)

3. Evaluation & Discussion

3.1 Research Method

The main study consisted of a two-group post-test only experimental research design, and was used to answer the following research questions:

RQ1: Did students who worked with LEMA develop modeling abilities?

RQ2: Which features in the LEMA did students perceive to be helpful in answering questions related to modeling abilities?

Before the main study, a pilot study was conducted to test the validity and usability of the learning materials in LEMA and the validity of the post-test. Students from the 1st year undergraduate Bachelor of Science (B.Sc.) program from various colleges under Mumbai University, India, were chosen as the sample. A quasi experimental research design was adopted. The students (N=73) who arrived at the experiment venue were assigned to two groups by randomized assignment. Group 1 (Experimental group) contained 37 students while Group 2 (control group) contained 36 students. Students in the control group were given a visualization which contained the same animation of the microscopic phenomenon, but did not contain the scaffolds and prompts present in LEMA. A total time period of 1 hour was allotted to the students for learning the topic. At the end of the hour, a new physical phenomenon was presented to the student by means of an simulation depicting its microscopic explanation. In order to answer RQ1 related to students' development of modeling abilities, we administered a post test which contained open ended questions that mapped to each modeling sub ability. To answer RQ2 on students' perceptions of useful features of LEMA, a reflection questionnaire was used as the instrument. Students were asked to rate each feature of LEMA on a scale of 0-2 where 0-Not Helpful, 1-SomeWhat Helpful, 2-Very Helpful. To grade the answers of the students to the post-test questions, scientific abilities rubrics (Etkina, et.al., 2006) were used.

3.2 Results

The inter rater reliability for the raters was calculated and the value of Cohen's Kappa was found to be 0.839 with $p < 0.001$. Post analysis of the post test results using a Mann-Whitney U-test, we found that the experimental group (LEMA) showed a statistically significant difference at $p = 0.05$ level in their improvement in their abilities of making observations, predictions, testing them and then revising them as compared to the control group.

Table 1: Mann-Whitney U-test Scores.

Ability to describe observations	Ability of devising an explanation for an observed pattern	ability of making a prediction based on explanation	ability of testing a prediction	ability of revising a prediction
p=0.195	p=0.000	p=0.003	p=0.014	p=0.008

From the student perception data, we find the following percentage of students from the LEMA group who found each feature very-useful. (NA =Not Applicable)

Table 2: Student perceptions of usefulness of a feature.

Ability	Simulation of Microscopic model	Prediction Questions	Justification on Box	Multiple Representations	Experimental Results for comparison and judgement	Assertion and Reasoning Questions
Predict	70.27%	64.86%	51.35%	70.27%	NA	NA
Test	72.97%	NA	NA	59.45%	72.97%	NA
Revise	64.86%	NA	NA	56.75%	NA	56.75%

We find that both groups did well in the ability of describing observations without explanations, but, the experimental group performed significantly better than the control group for all the other sub abilities, namely, the ability to devise explanation for an observed pattern, ability to make a reasonable prediction based on explanation, ability to decide whether the prediction and the outcome agree/disagree and the ability to revise the explanation when necessary. Since the only difference in treatment for the two groups was the learning material, we can argue that the features of LEMA lead to the improvement in students modeling skills. Factors such as proficiency in English, test with only one topic, data from one study as evidence could be limitations of this study. The main contribution of our work is the identification of design components of a ICT-based learning environment that explicitly targets students' modeling abilities. Future work involves creation of more number of LEMA modules in a variety of topics.

References

- Bereiter, C., & Bird, M. (1985). Use of thinking aloud in identification and teaching of reading comprehension strategies. *Cognition and instruction*, 2(2), 131-156.
- Davis, E. A. (2000). Scaffolding students' knowledge integration: Prompts for reflection in KIE. *International Journal of Science Education*, 22(8), 819-837.
- Etkina, E., Brookes, D. T., Murthy, S., Karelina, A., Villasehor, M. R., & Van Heuvelen, A. (2006, October). Developing and assessing student scientific abilities. In *STEM Assessment Conference* (p. 68).
- Gilbert, J. (2004). Models and modeling: Routes to more authentic science education. *International Journal of science and mathematics education*, 2, 115-130
- Grosslight, L., Unger, C., Jay, E., & Smith, C. L. (1991). Understanding models and their use in science: Conceptions of middle and high school students and experts. *Journal of Research in Science teaching*, 28(9), 799-822.
- Gabel D., (1998), The complexity of chemistry and implications for teaching, In B. J. Fraser and K. G. Tobin (Eds.), *International handbook of science education* (pp. 233-248). Dordrecht, The Netherlands: Kluwer Academic Publishers.
- Kozma, R., Chin, E., Russell, J., & Marx, N. (1997). The roles of representations and tools in the chemistry laboratory. (Tech. Rep.). Menlo Park, CA: SRI International.
- Linn, M. C., & Slotta, J. D. (2000). WISE science. *Educational Leadership*, 58(2), 29-32.
- National Research Council (Ed.). (1996). *National science education standards*. National Academy Press.
- Linn, M. C., & Hsi, S. (2000). *Computers, teachers, peers: Science learning partners*. Routledge.
- Lin, X., & Lehman, J. D. (1999). Supporting learning of variable control in a computer-based biology environment: Effects of prompting college students to reflect on their own thinking. *Journal of Research in Science Teaching*, 36(7), 837-858.
- Lee, A. T., Hairston, R. V., Thames, R., Lawrence, T., & Herron, S. S. (2002). Using a computer simulation to teach science process skills to college biology and elementary education majors. *Bioscene: Journal of College Biology Teaching*, 28(4), 35-42.
- Nicol, D. J., & Macfarlane-Dick, D. (2006). Formative assessment and self-regulated learning: a model and seven principles of good feedback practice. *Studies in higher education*, 31(2), 199-218.
- Raghavan, K., Kesidou, S., & Sartoris, M. (1993). Model-centered curriculum for model-based reasoning. In *The Proceedings of the Third International Seminar on Misconceptions and Educational Strategies in Science and Mathematics (On-line)*. Ithaca, NY: Misconceptions Trust.
- Raghavan, K., & Glaser, R. (1995). Model-based analysis and reasoning in science: The MARS curriculum. *Science Education*, 79(1), 37-61.
- Robinson, I. S. (1987). A Program to Incorporate High-Order Thinking Skills into Teaching and Learning for Grades K-3.
- Etkina, E., & Van Heuvelen, A. (2007). Investigative science learning environment—a science process approach to learning physics. *Research-based reform of university physics*, 1.
- Treagust, D. F., Chittleborough, G., & Mamiala, T. L. (2002). Students' understanding of the role of scientific models in learning science. *International Journal of Science Education*, 24(4), 357-368.
- Verschaffel, L., & De Corte, E. (1997). Teaching realistic mathematical modeling in the elementary school. A teaching experiment with fifth graders. *DOCUMENT RESUME*, 113.
- Wielinga, B. J., Schreiber, A. T., & Breuker, J. A. (1992). KADS: A modelling approach to knowledge engineering. *Knowledge acquisition*, 4(1), 5-53.
- Wells, M., Hestenes, D., & Swackhamer, G. (1995). A modeling method for high school physics instruction. *American Journal of Physics*, 63(7), 606-619.

Evaluation of the Effectiveness of a Digital Microscope System with Tabletop Interface in a Science Class

Kazuyuki MORITA^{a*}, Norio SETOZAKI^b, Yusuke MORITA^c

^a*Graduate School of Human Sciences, Waseda University, Japan*

^b*Faculty of Education, Nagasaki University, Japan*

^c*Faculty of Human Sciences, Waseda University, Japan*

*k.morita@akane.waseda.jp

Abstract: This study examined the effects of utilizing a digital microscope system with tabletop interface in an elementary school science class. The findings show that the equipment was more effective than optical microscopes for microscopic observation tasks such as finding, focusing, and sketching.

Keywords: Tabletop, Multi-touch, Microscope observation

1. Introduction

In science class, elementary students observe water microorganisms by taking turns using an optical microscope. However, it is difficult for them to observe and sketch the same object. In order to facilitate students' discussion and cooperation, a new tool for the observation of microorganisms is needed.

Kitahara et al. (2006) showed that a tabletop interface was effective in collaborative learning. Moreover, there are studies of observations using digital microscopes instead of optical microscopes (Tessmer et al., 2011; Dickerson et al., 2007; Van Scoter, 2004). Morita et al. (2013) developed a digital microscope system with tabletop interface and showed that microscopic observations using this system were useful for understanding water microorganisms. Therefore, this study examines the effects of utilizing this equipment for microorganism observation education.

2. Procedure

2.1 *Digital Microscope System with Tabletop Interface*

Figure 1 illustrates the digital microscope system with tabletop interface (MT-SCOPE). MT-SCOPE consists of a multi-touch screen and digital microscope. The multi-touch screen has infrared LEDs, an acrylic sheet, a tracing paper, and an infrared camera. The system is capable of scaling, rotating, and moving microscope photos and videos through multi-touch operation.

2.2 *Subjective Assessment by Survey*

A total of 33 elementary school students participated in this study. After operating both types of equipment (optical microscope, MT-SCOPE), they responded to nine questions by selecting from the following four responses: Strongly Agree, Agree, Disagree, and Strongly Disagree. The positive (Strongly Agree and Agree) and negative (Disagree and Strongly Disagree) responses were totaled for each item and compared using Fisher's exact test.



(Sketching microorganisms)



(Observing microorganisms with multi-touch)

Students using MT-SCOPE

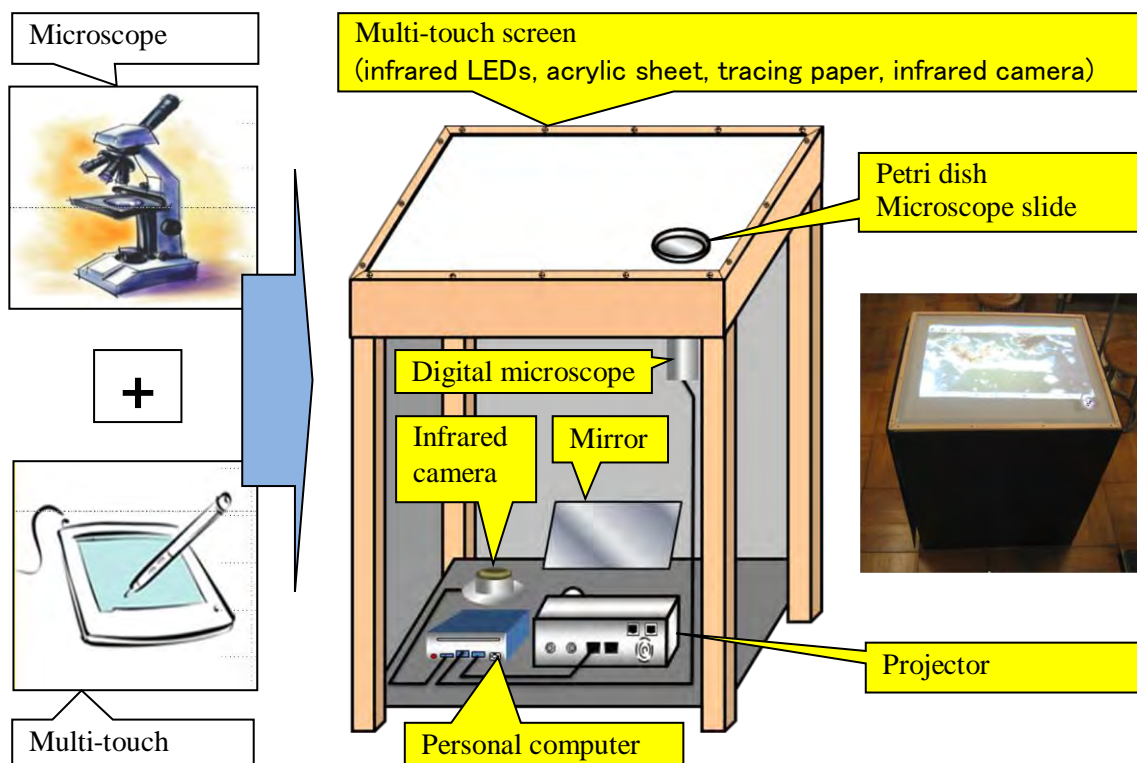

Figure 1. The Digital Microscope System with a Tabletop Interface for Microscope Observation.

3. Results and Discussion

Table 1 shows the results of Fisher's exact test. All the students responded in the affirmative to the statements "It was easy for me to find the water microorganisms" ($p < .01$) and "It was easy for me to adjust the focus" ($p < .01$). Moreover, there were many affirmative replies for "It was easy for me to sketch the water microorganisms" ($p < .01$) and "I found the water microorganisms" ($p < .05$). The results suggest that MT-SCOPE was more effective than optical microscopes for microscopic observation.

Conversely, there were a number of negative replies for "I discussed the water microorganisms with my group members" ($n.s.$). This seems to indicate that the design of observation lessons needs to be improved in the future.

Table 1: Results of the subjective assessment.

Question Categories	Equipment	Positive		Negative		Fisher's Exact Test
		Strongly Agree	Agree	Disagree	Strongly Disagree	
It was easy for me to find the water microorganisms.	MS	15	12	4	2	**
	MT	19	13	1	0	
It was easy for me to adjust the focus.	MS	5	10	16	2	**
	MT	16	14	3	0	
It was easy for me to sketch the water microorganisms.	MS	10	11	10	2	**
	MT	17	15	1	0	
I found the water microorganisms.	MS	15	12	4	2	*
	MT	31	2	0	0	
I observed the water microorganisms.	MS	19	10	2	2	n.s.
	MT	31	1	1	0	
I discussed the water microorganisms with my group members.	MS	9	15	5	4	n.s.
	MT	15	10	6	2	
After taking the practical class, I have become eager to learn more about water microorganisms.	MS	20	8	1	4	n.s.
	MT	22	7	2	2	
After taking the practical class, I have become eager to learn more about other microorganisms.	MS	23	5	2	3	n.s.
	MT	24	7	1	1	
I enjoyed this microscope observation lesson.	MS	25	5	2	1	n.s.
	MT	30	2	1	0	

MS: Optical microscope, MT: MT-SCOPE, ** $p < .01$, * $p < .05$, n.s.: not significant.

4. Conclusion

This study examined the effects of utilizing MT-SCOPE in an elementary school science class. The findings show that the equipment was more effective than optical microscopes for microscopic observation tasks such as finding, focusing, and sketching. Using the data from this study, future research should focus on improving MT-SCOPE and examining its effective practical uses in elementary schools.

References

- Dickerson, J., & Kubasko, D. (2007). Digital Microscopes: Enhancing Collaboration and Engagement in Science Classrooms with Information Technologies. *Contemporary Issues in Technology and Teacher Education*, 7 (4), 279-292.
- Kitahara, K., Inoue, T., Shigeno, H., & Okada, K. (2006). A tabletop interface for collaborative learning. *Journal of Information Processing Society of Japan*, 47(11), 3054-3062.
- Morita, K., Setozaki, N., & Morita, Y. (2013). Development and evaluation of digital microscope system with multi-touch interface. *Journal of Japan Society for Educational Technology*, 37(Suppl.), 169-172.
- Tessmer, M., & Cowlshaw, R. (2011). Time for Slime. *Science and Children*, 49(4), 38-41.
- Van Scoter, J. (2004). Using Digital Images to Engage Young Learners. *Learning & Leading with Technology*, 31 (8) 34, 35, 37.

Circuitously Collaborative Learning Environment to Enhance Metacognition in Solving Mathematical Word Problem

Tama DUANGNAMOL^{†‡*}, Boontawee SUNTISRIVARAPORN[‡]
Thepchai SUPNITHI[§], Mitsuru IKEDA[†]

[†]*School of Knowledge Science, Japan Advanced Institute of Science and Technology, Japan*

[‡]*School of Information, Computer, and Communication Technology*

Sirindhorn International Institute of Technology, Thammasat University, Thailand

[§]*National Electronics and Computer Technology Center, Thailand*

*d.tama@jaist.ac.jp

Abstract: This article reveals the design of an ongoing research that investigates the effectiveness of an alternative learning environment Circuitously Collaborative Learning Environment (CirCLE), which is designed to enhance metacognitive awareness on the learning processes in algebraic mathematical word problem (MWP) solving environments. We perform the research based on the hypothesis that a student will be encouraged and can reflect his own thinking when he practicing a role of an inspector together with receiving appropriate feedback to revise his solutions.

Keywords: Metacognition, problem solving, peer assessment, collaborative learning

1. Introduction

In a usual collaborative learning environment, students have opportunities to share and are engaged in discussion to take responsibility for their own learning (Gokhale, 1995). However, research in Computer-Supported Collaborative Learning (CSCL) showed that it is difficult to clearly define the interaction between the initial conditions of collaboration and learning outcomes. Moreover, collaboration leads to positive outcomes only when students engage in knowledge-generative interactions such as giving explanations, and engaging in argumentation, negotiation, conflict resolution or mutual regulation (Dillenbourg & Jermann, 2007). To say that, it is not effective in noncompetitive groups or inactive students. To solve mathematical problems, it is necessary for students to think on their own cognitive strategy to deeply understand how the problems solved. Therefore, in this study, we propose an alternative learning environment, namely Circuitously Collaborative Learning Environment (CirCLE), which provides chances for participants to learn actively to solve algebraic mathematical word problems, in which students learn to solve MWP's by translating context problems into mathematical notations. Two key components, which are used to compose CirCLE, are a management strategy, named Peer Inspection (PI) strategy, and a communication media, named Inferential Diagram (ID). We intentionally design them to support students' metacognition by providing chances to reflect their cognition and rethink their learning strategy. The detail of PI and ID will be revealed in the rest sections.

2. Peer Inspection Strategy

PI is counted as a *formative peer assessment*; peer feedback is given while the learning is actually happening, helping students plan their own learning, identify their own strengths and weaknesses, target areas for remedial action, and develop metacognitive and other skills (Topping, 2009). The aim for designing PI is to be a learning management strategy for raising the learning of students both as *assessors* (reciprocal teaching (Palincsar & Brown, 1984)) and *assesseees* in meta-level through

modified peer assessment activities. The modified peer assessment activities in PI are composed of three main stages;

- i) *Problem providing*: Nakano, Hirashima, and Takeuchi (2002) mentioned that it is important to consider the differences of problems in understanding the problems deeply. In PI, to encourage students to focus on their own problem, a teacher, therefore, provides distinct problems for each student.
- ii) *Peer selection*: Each student will be assigned to inspect suitable works of peers by their learning performance; high performance (HP), average performance (AP), and low performance (LP), to simulate an environment that he/she can learn effectively. For example, for LP students who have no idea how to start, at least two correctly complete examples (If there is no correctly complete solution, a teacher will provide) should be assigned to them to let them follow or learn how to solve problems correctly and they also can use those examples as keys for inspecting assigned solutions of other peers.
- iii) *Peer feedback*: Challenging feedback corresponding to students' performance are also important (the teacher provides this), e.g., an HP student should receive feedback to against his idea, which will make him rethink on his own solutions. AP and LP students should receive properly correct feedback as guidance to revise their solution not to confuse them.

Furthermore, in this research, we also propose Initial Diagram (ID) as a solution method to be a communication media among participants to support and enhance potential of PI. The detail of ID is revealed in the following section.

3. Inferential Diagram

Perceptual inferences can be made more easily than symbolic inferences (Koedinger, 1991), therefore we design ID as a tool to externalize steps of inference when students solving MWP. It is used as a communication media among participants to reduce the complexity of commenting process and to foster students in reflecting their thinking process when solving MWP.

3.1 Providing a solution of MWP using Inferential Diagram

To encourage a student to aware of solving MWP, we propose solution method, called Inferential Diagram (ID), in which a student has to explicitly state any information or statement by expressing its source or reason why he need it. In the user interface of the proposed system, see the figure 1(a), there are six necessary buttons; 1) 'Goal' button is used to state a problem goal, 2) 'subGoal' button is used to state sub-goal of a problem, 3) 'Given' button is used to illustrate information given, 4) 'Fact' button is used to refer common fact, theorems, common rules, or axioms, 5) 'Text' button is used to state reason or any other statements, and 6) 'Link' button is used to create a link between information nodes. To illustrate the relation between information nodes, a student can put

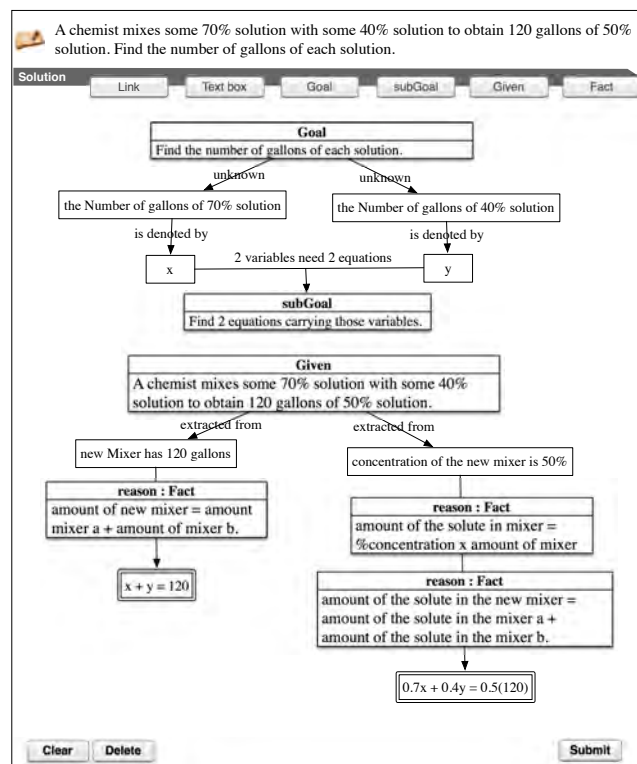

(a)

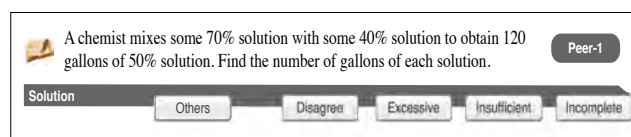

(b)

Figure 1. Providing solution using Inferential Diagram; (a) student interface and (b) peer interface

any text box on the link. See figure 1(a), the diagram could be interpreted as follows, ‘the Number of gallons of 70% solution is denoted by x’, ‘Since, there are 2 variables (x and y), then 2 equations carrying those 2 variables are required’, ‘The problem gave that the mixer has 120 gallons and because there is the fact that “*amount of new mixer = amount mixer a + amount of mixer b*” and from the assumption, then the equation could be formed as $x + y = 120$ ’, etc.

3.2 Commenting peer’s solution via inferential diagram

It is not an easy task for some students to comment on peers’ works. Therefore, ID is designed to support students in this task. In CirCLE, by using ID, we provide five example comments as options; i) ‘*I do not agree with an Information in node A*’, ii) ‘*I do not agree with an Information in node A*’, iii) ‘*Does this reason make sense?*’, iv) ‘*Insufficient Information to infer A*’, and v) ‘*Incomplete solution*’. The difference between the student interface and the peer interface are the command buttons; see figure 1(b) comparing to the figure 1(a). To indicate that, for example, if one does not agree with information in a node-A, he can click on the node-A following by clicking on ‘Disagree’ button. In addition to provide an opened comment, a student can use the ‘Other’ button to add additional comments. To construct connections between previous and new knowledge, metacognitive questions, such as, ‘what are the similarities/differences between the problem you are assigned and the problems you have to inspect? and why?’ and questions, such as, ‘what are the strategies/tactics/principles appropriate for solving the problem and why?’, will be used to criticize students during their learning process.

4. Conclusion

Since, in CirCLE, students are not directly assigned to work in group, but in a class of specific topic in which all students have the same goal, the students share their solutions anonymously, they comment peers’ solutions, together with receiving feedbacks from peers’ inspection, then, revise their own solutions using those comments and experiences from inspecting peers’ works, therefore the term ‘Circuitously Collaborative Learning’ was used.

In this study, we aim to develop a computer-supported learning environment, which supports students’ self-learning regulation to motivate students’ metacognition. Therefore, CirCLE is designed to encourage a student’s metacognition by supporting a student’s self-regulated learning and reflecting his learning process. It is aimed that students can learn more effective and deeply understand MWP and they can be enhanced their metacognition via CirCLE.

Acknowledgement

This research is supported in part by JAIST-SIIT-NECTEC dual degree program, and Development and Promotion of Science and Technology Talents Project (DPST scholarship), Thailand.

References

- Dillenbourg, P., & Jermann, J. (2007). Designing integrative scripts. In *Scripting Computer-Supported Collaborative Learning - Cognitive, Computational, and Educational Perspectives (Computer-Supported Collaborative Learning Series)* (pp. 275-301). Heidelberg: Springer.
- Gokhale, A. A. (1995). Collaborative Learning Enhances Critical Thinking. *Journal of technology education* , 7 (1).
- Koedinger, K. (1991). *Tutoring Concepts, Precepts, and Rules in Geometry Problem Solving*. Pittsburgh: Carnegie Mellon University.
- Nakano, A., Hirashima, T., & Takeuchi, A. (2002). A Support Environment for Learning by Describing Problem Map. *International Conference on Computers in Education* (pp. 119-123). Auckland: IEEE Computer Society.
- Palincsar, A. S., & Brown, A. L. (1984). Reciprocal teaching of comprehension fostering and comprehension monitoring activities. *Cognition and Instruction* , 1, 117-175.
- Topping, K. J. (2009). Peer Assessment. *Theory Into Practice* , 48 (1), 20-27.

A Mathematical Model of Collaborative Learning using Differential Equations

Shinnosuke NISHI^a, Yasuyuki NAKAMURA^{a*}, Koichi YASUTAKE^b, Osamu YAMAKAWA^c

^aGraduate School of Information Science, Nagoya University, Japan

^bGraduate School of Social Sciences, Hiroshima University, Japan

^cCenter for Arts and Sciences, Fukui Prefectural University, Japan

*nakamura@nagoya-u.jp

Abstract: This study presents a mathematical learning model for collaborative learning using differential equations. We first specify initial knowledge about a subject and each student's ability to understand the subject. Then, we analyze the evolution of students' knowledge over time. Our findings show that the effect of collaborative learning depends on how students are grouped together. These results can suggest ways of designing a class for effective collaborative learning.

Keywords: Collaborative learning, Mathematical modeling, Differential equation

1. Introduction

In recent years, numerous studies have shown the effectiveness of collaborative learning. However, most of these are inductive studies in which pedagogical findings are derived by observing students in the classroom. In contrast, a deductive approach leads to a conclusion from a general premise. Therefore, if we had a general framework as a premise for collaborative learning, we could design a class for effective collaborative learning. In this study, we construct a mathematical learning model to function as a general framework for collaborative learning.

Existing mathematical models of the teaching-learning process can be classified into three categories: differential equation modeling (Pritchard et al., 2008), Ising spin modeling (Bordogna et al., 2001, 2003; Yeung, 2006; Yasutake, 2011), and stochastic process modeling (Nitta, 2010). Note that the model of Pritchard et al. (2008) only applies to individual learning. In this study, we extend his model to use differential equations to describe collaborative learning.

2. Mathematical learning model by using different equation

2.1 Pritchard's model

Let us briefly review Pritchard's model. He introduces the following model to describe the evolution of a student's knowledge over time: $dK(t)/dt = \alpha_1\beta(1-K(t))K(t) + \alpha_2(1-\beta)(1-K(t))$. Here, the student's knowledge at time t is given by $K(t)$ ($0 \leq K(t) \leq 1$). The first term of the right-hand side of this model is motivated by the constructivist view in which students learn new knowledge by constructing an association between it and some prior knowledge. Here, α_1 is the probability that something taught to a student will be retained in his/her mind for potential learning. The second term is motivated by the tabula rasa theory of learning, and α_2 describes a learning rate similar to α_1 . The tabula rasa theory assumes that a student's memory is blank before learning begins. Finally, β is a parameter that determines the ratio of the learning effect of the two terms.

2.2 Our model

We describe the time evolution of the i -th student's knowledge during collaborative learning with another student as follows:

$$\frac{dK_i(t)}{dt} = c(\beta\alpha_i K_i(t)(1 - K(t)) + (1 - \beta)\alpha_i(1 - K_i(t))) + d \sum_{j \neq i} f_i(K_j(t) - K_i(t))(K_j(t) - K_i(t)) + e \sum_{i \neq j} g_i(K_i(t) - K_j(t))$$

where functions $f_i(x), g_i(x)$ are defined as

$$f_i(x) = \begin{cases} \alpha_i & x > 0 \\ 1 - \alpha_i & \text{otherwise} \end{cases} \quad g_i(x) = \begin{cases} 1 - K_i(t) & x > 0 \\ 0 & \text{otherwise} \end{cases}$$

The first term of our model is similar to Pritchard's model. We introduce α_i , which reveals the i -th student's ability to understand, instead of α_1, α_2 in Pritchard's model. The second term represents a learning effect in which students gain knowledge by being taught by other students. When the j -th student's knowledge is greater than that of the i -th student ($K_j(t) - K_i(t) > 0$), the higher the value of α_i , the more knowledge the i -th student gains. Conversely, when the j -th student's knowledge is lower than that of the i -th student ($K_j(t) - K_i(t) < 0$), the higher the value of α_i , the less the negative effect is on the i -th student. The third term of our model represents the gain in students' knowledge when they teach something to other students. This effect is revealed only if the i -th student's knowledge is greater than that of the j -th student. The lower the i -th student's knowledge, the greater the learning effect the i -th student gains. The ratio of three terms is determined by the values of c, d , and e .

3. Results and discussion

3.1 Calculation results

We set the initial knowledge about a subject when a student starts studying and each student's ability to understand the subject as a control parameter. Under these conditions, we analyze the evolution over time of a student's knowledge in collaborative learning with three other students. Here, we show two characteristic results of our study. One result is obtained for case (a) $K_1(0) = 0.1, \alpha_1 = 0.1, K_2(0) = 0.3, \alpha_2 = 0.3, K_3(0) = 0.6, \alpha_3 = 0.6$, and $K_4(0) = 0.8, \alpha_4 = 0.8$, for student 1, 2, 3, and 4, respectively. The other result is obtained for case (b) $K_1(0) = 0.1, \alpha_1 = 0.5, K_2(0) = 0.2, \alpha_2 = 0.6, K_3(0) = 0.3, \alpha_3 = 0.7$, and $K_4(0) = 0.4, \alpha_4 = 0.8$, for student 1, 2, 3, and 4, respectively.

Those two results are shown in Figure 1 (a) and (b). The red lines denote collaborative learning and the blue lines denote individual learning. In case (a), collaborative learning is less effective for those students who have a high level of initial knowledge or a high ability to understand the subject. In case (b), collaborative learning is effective for all students.

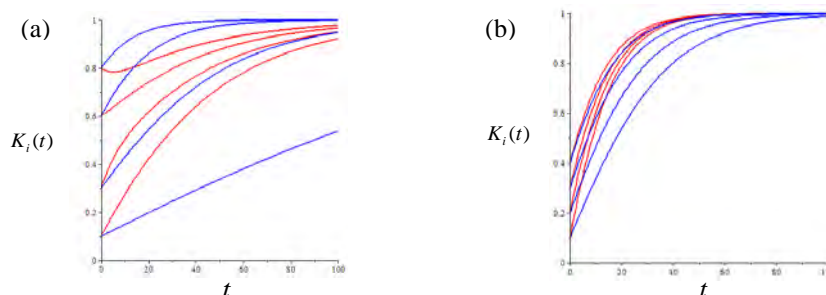

Figure 1. The time evolution of students' knowledge during collaborative learning (red lines), with $\beta = 0.5, c = d = e = 0.1$, and individual learning (blue lines), with $\beta = 0.5, c = 0.1, d = e = 0$.

3.2 Comparison between inductive research and deductive research

Our model could apply to a variety of learning situations. Therefore, we compare the inductive research method, such as observing students in a classroom, to our deductive mathematical model. Nitta introduces stochastic process modeling (Nitta (2010)). He observed students in a classroom solving multiple-choice questions about introductory physics. The students solved a question, then solved the same question again soon after discussing it with other students. He calculated the percentage of students choosing the correct answer before and after collaborative learning took place. We investigated the initial knowledge and transitional knowledge at time $t = 10$ for each student, which corresponded with the students' knowledge before and after discussing the problem with other students. Then, we compared our results to his. Figure 2 shows that the two results are qualitatively similar. Therefore, we can say our model is appropriate.

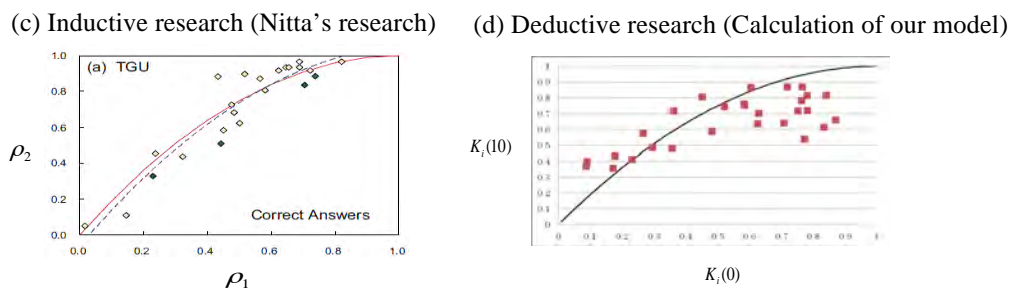

Figure 2. (c) Relationship of percentage of students choosing correct answer before (ρ_1) and after (ρ_2) collaborative learning [Reprint from Nitta (2010)]; (d) Relationship between initial knowledge and transitional knowledge at time $t = 10$ in the case of collaborative learning.

4. Conclusion

Our findings show that the effect of collaborative learning depends on the way students are grouped. In case (b), collaborative learning is more effective than individual learning. Therefore, collaborative learning appears to be more effective when students who have a high ability to understand learn a new subject. However, according to our model, in some cases (e.g., case (a)), the learning effect of collaborative learning is limited when students who have a high amount of initial knowledge or ability to understand engage in collaborative learning. Mathematical learning models are important, because they enable us to discuss the effect of collaborative learning in a variety of learning situations. Finally, we compared our simulation result with actual classroom data. However, our mathematical model needs to reflect how learning takes place in a classroom in more detail.

Acknowledgements

This work was supported by JSPS KAKENHI Grant Number 26282033.

References

- Bordogna, C. M. & Albano, E. V. (2001). Theoretical Description Teaching-Learning Processes: A Multidisciplinary Approach. *Physical Review Letters*, 87(11), 118701-1-4.
- Nitta, H. (2010). Mathematical theory of peer-instruction dynamics, *Physical Review Special Topics - Physics Education Research* 6, 020105-1-4.
- Pritchard, D. H. & Lee, Y.-J. (2008). Mathematical learning models that depend on prior knowledge and instructional strategies, *Physical Review Special Topics - Physics Education Research*, 4, 010109-1-8.
- Yeung, Y.-Y. (2006). Scientific Modeling of Technology-Mediated Collaborative Learning Process. In Mizoguchi, R., Dillenbourg, P. & Zhu, Z. (Eds.), *Learning by Effective Utilization of Technologies: Facilitating Intercultural Understanding*, (pp. 249-256). Amsterdam, The Netherlands: IOS Press.
- Yasutake, K., Yamakawa, O., Tagawa, T., Sumiya, T. & Inoue, H. (2011). A Simulation Analysis on Learning Effects through Interactions in Networked Communities (in Japanese), *Transactions of Japanese Society for Information and Systems in Education*, 28(1), 50-60.

Pre-service Teacher Existing Ideas of Using Computer-Supported for Scientific Inquiry

Jiraporn TUPSAI^{ab}, Jirakan YUENYONG^b, and Chokchai YUENYONG^{a*}

^a*Science Education Program, Faculty of Education, Khon Kaen University, Thailand*

^b*Khon Kaen University Demonstration School, Khon Kaen, Thailand*

* ychok@kku.ac.th

Abstract: The study aimed to examine physics pre-service teacher existing ideas of computer-supported for inquiry physics learning and learning. Methodology is qualitative research. The research will interpret physics pre-service teacher existing ideas of computer-supported for inquiry physics learning and learning through framework of Chinn & Malhotra (2002) epistemology and cognitive processes of scientific inquiry. Participants included 15 physics pre-service teachers who enrolled for teaching practices in schools for one year, in Thailand. The questionnaire of Using Computer-Supported for Scientific Inquiry (QCSI) and interviewing were tools for interpreting physics pre-service teacher existing ideas of computer-supported for scientific inquiry. The findings revealed that the most of participants perceived few aspects of cognitive process of scientific inquiry when they gave the ideas of using computer-supported for physics teaching. Only three of six aspects of epistemology of scientific inquiry were found from physics pre-service teachers' ideas. These included responses to anomalous data, purpose of research, and theory-data coordination.

Keywords: Computer-supported, physics, scientific inquiry, pre-service teacher

1. Introduction

Although there are many potential benefits to using inquiry in a science classroom, many research found that teachers face challenges in implementing inquiry (Abd-El-Khalick et al. 2004). Teachers have a number of barriers to implementing inquiry in the classroom. In order to provide powerful chance of scientific inquiry, teachers should gain knowledge and skills of providing scientific inquiry activities. The computer-supported is another solution of generating inquiry experiment and situation (Chen et.al. 2013). In recent years, a number of computer-supported inquiry-based science learning environments have been created and studied with aiming to facilitate the development of cognitive and metacognitive strategies in pupils (Minocha & Thomas, 2007). However, it seemed that teachers had some difficulty to provide computer-supported for science teaching and learning (Maishra & Koehler, 2006). In order to enhance teachers to develop their knowledge of computer-supported science inquiry shift from simple to authentic inquiry, examining of their existing ideas about this should be addressed. This study attends to this issue by examining physics pre-service teacher existing ideas of computer-supported for inquiry physics learning and learning. To clarify the continuum of scientific inquiry, the scientific reasoning is the central issue of distinguishing. This study will adopt Chinn & Malhotra (2002) epistemology and reasoning processes of authentic science as framework of clarifying pre-service teachers' existing ideas of computer-supported for scientific inquiry.

2. Methodology

Methodology is qualitative research. The research will interpret physics pre-service teacher existing ideas of computer-supported for inquiry physics learning and learning through framework of Chinn & Malhotra (2002) epistemology and cognitive processes of scientific inquiry.

2.1 Participants

Participants included 15 physics pre-service teachers who enrolled for teaching practices in schools for one year, in Thailand. These pre-services have planned to provide computer-supported for physics teaching and learning when they are teaching in schools.

2.2 Data collection

The questionnaire of Using Computer-Supported for Scientific Inquiry (QCSI) and interviewing were tools for interpreting physics pre-service teacher existing ideas of computer-supported for scientific inquiry. The QCSI provided three open-ended questions about computer-supported for scientific inquiry in order to probe their ideas of inquiry in aspects of epistemology and cognitive processes. Then, the interviewing was carried out in order to further probe what pre-service exactly mean or respond to the QCSI.

2.3 Data Analysis

Participants' responding was categorized into different existing ideas of computer-supported for scientific inquiry. Chinn & Malhotra (2002) epistemology and cognitive processes of scientific inquiry was referenced as expected ideas of providing computer-supported for scientific inquiry.

3. Findings and Discussion

Pre-service teachers' ideas seemed to lack of providing computer-supported for inquiry. However, some parts of their ideas could be counted into some aspects of cognitive processes and epistemology of scientific inquiry as follow:

3.1 Existing ideas about aspects of cognitive processes in using computer-supported for scientific inquiry

Table 1: Existing ideas about aspects of cognitive processes in using computer-supported for scientific inquiry

Aspects of cognitive processes	Frequency (N = 15)	Percents
Generating research questions	5	33.33
Designing studies	4	26.67
Making observations	9	60.00
Explaining results	2	13.33
Developing theories	0	0.00
Studying research reports	2	13.33

It found that the most of participants perceived few aspects of cognitive process of scientific inquiry as showed in Table 1. They aware of computer-supported could be organized for physics inquiry in some aspects. It is only simple scientific inquiry. Number of them perceived that computer-supported could help making observation. However, their making observation would be only counted for transforming observations. Cognitive processes of inquiry on aspects of making observations, explaining results, studying research reports and designing studies were mentioned in their explanation. Even though, their ideas could be interpreted into some aspects of cognitive process of scientific inquiry, they also misunderstood in some issues of scientific inquiry e.g. making observations, and explaining results.

For example, Prin pre-service teachers' ideas of computer-supported for physics learning could be interpreted his cognitive processes of inquiry in three aspects including making observations, explaining results, studying research reports. His idea about explaining results was provided only aspect of transforming observations which refer to one or more rounds of data transformation. However, some of them seemed to he have no ideas to use computer-supported for scientific inquiry. Bell pre-service teacher thought that cognitive process of inquiry could be read from sentences or pictures provided in the websites rather than constructing from human endeavors during inquiry tasks.

3.2 Existing ideas about aspects of epistemology in using computer-supported for scientific inquiry

The findings indicated that participants have some perceived about epistemology of scientific inquiry when they showed the ideas of providing computer-supported for physics teaching and learning. Only three of six aspects of epistemology of scientific inquiry were found from physics pre-service teachers' ideas. These included responses to anomalous data, purpose of research, and theory-data coordination as showed in Table 2.

Table 2: Existing ideas about aspects of epistemology in using computer-supported for scientific inquiry

Aspects of cognitive processes	Frequency (N = 15)	Percents
Purpose of research	7	46.67
Theory-data coordination	6	40.00
Theory-ladenness of methods	0	00.00
Responses to anomalous data	3	20.00
Nature of reasoning	0	0.00
Social construction of knowledge	0	0.00

For example, Lompad pre-service teacher's ideas reflected that he held idea of theory-data coordination. His explanation could be interpreted that he aware of giving students chance to generate scientific knowledge from data to theories. It showed existing idea about relationship of theories and data. Interestingly, epistemology of scientific inquiry in aspects of theory-ladenness of methods, nature of reasoning, social construction of knowledge seemed to has difficulty of organizing in Thai physics classroom. These three aspects related to argumentation in scientific classroom. This finding consistency to previous studies of Thai classroom (Ketsing& Roadrangka, 2010) that discussed that Thai science classroom needs to support argumentation in classroom.

4. Conclusion

It showed that most of physics pre-service teachers' existing ideas about computer-supported were provided for motivation of physics learning, scientific model, remote learning, simulation for abstract concepts or dangerous experiments, database, instructional media, and flipped learning. However, most of them lack of how to provide computer-supported in physics teaching as authentic inquiry. Few aspects of cognitive process of scientific inquiry had showed when they gave the ideas of using computer-supported for physics teaching. Only three of six aspects of epistemology of scientific inquiry were found from physics pre-service teachers' ideas. This suggests that epistemology and cognitive process of scientific inquiry should be concerned when teachers develop computer-supported for science learning.

References

- Asay, L.D. & Orgill, M.K. (2010) Analysis of Essential Features of Inquiry Found in Articles Published in The Science Teacher, 1998–2007, *Journal of Science Teacher Education*, 21:57–79
- Abd-El-Khalick, F., Boujaoude, S., Duschl, R., Lederman, N. G., Mamlock-Naaman, R., Hofstein, A., et al. (2004). Inquiry in science education: International perspectives, *Science Education*, 88, 397– 419.
- Ketsing, J. & Roadrangka, V. (2010). Case study of science teachers' understanding about teaching for scientific inquiry. *Kasetsart Journal (social science)*, 31(1): 1 – 16.
- Chinn, C.A, & Malhotra, B. A. (2002). Epistemologically Authentic Inquiry in Schools: A Theoretical Framework for Evaluating Inquiry Tasks, *Science Educaiton*, 86: 175 – 218.
- Chen, W.; Looi, C.; Xie, W. & Wen, Y. (2013). Empowering argumentation in the science classroom with a complex CSCL environment. In S. C., Tan et al. (Eds.), *Proceedings of the 21st International Conference on Computers in Education*. Indonesia: Asia-Pacific Society for Computers in Education
- Minocha, S., & Thomas, G.P. (2007). Collaborative learning in a wiki environment: Experiences from a software engineering course. *New Review of Hypermedia and Multimedia*, 13(2), 187-209.
- Mishra, P., & Koehler, M. J. (2006). Technological Pedagogical Content Knowledge: A Framework for Teacher Knowledge, *Teachers College Record*, 108(6), 1017 – 1054.

Remote Laboratory System for Technology-Enhanced Science Learning: The Design and Pilot Implementation in Undergraduate Courses

Siew Wei THO^{a,b*} and Yau Yuen YEUNG^a

^a*Department of Science and Environmental Studies, The Hong Kong Institute of Education, Hong Kong*

^b*Department of Physics, Sultan Idris Education University (UPSI), Malaysia*

*s1103379@s.ied.edu.hk

Abstract: In this study, a new remote laboratory (RL) system is developed through some innovative ideas and methods for practicing technology-enhanced learning of science in schools. The Internet-based RL system will enable students to control the server-side laboratory equipment and to carry out real-time scientific investigation activities at distance places. As a pilot study, a set of newly developed remote-controlled experiments were first tried out by a total of 64 undergraduate students who studied some science education and teacher training courses. The evaluation used mixed research method which included questionnaire survey and interviews as specifically developed by us to collect data on students' perceptions, views and implementation issues related to the use of the RL system. The survey findings showed that the participants agreed with the appropriateness of various educational merits of the RL system but negative comments and suggestions for improvement were also received. Through iteration of Design-Based Research (DBR), we have refined our RL system.

Keywords: remote laboratory, technology-enhanced learning, science education

1. Introduction

With the rapid advancement of technology and the prevalent use of Internet in education, science practical work in form of web-based laboratory or remote laboratory (RL) has recently been adopted in cloud computing. As a simple definition of the RL system, "the basic idea is for a user to connect via the Internet with a computer from place A to a real experiment carried out in place B" (Grober, Vetter, Eckert, & Jodl, 2007, p. 127). Recent education reforms have identified the importance of technology-enhanced science learning, which can be achieved in science education through RL system (Kong, Yeung, & Wu, 2009; Lowe, Newcombe, & Stumpers, 2013). Using this RL system, students can view and control apparatus/equipment in science experiments, and downloads real-time data in classroom, computer laboratory or even at their homes. Therefore, the RL can be considered as a kind of new development in technology-enhanced learning (TEL) in which appropriate technology and pedagogies are innovatively applied in science education.

The first part of this study is to design and develop of an innovative RL system through technology-enhanced inquiry for Hong Kong science education. Of course, we are aware that it is hard to evaluate this innovative system just based on the design or development itself. As a result, a pilot evaluation in two undergraduate classes was conducted as the second part of the study.

2. Research Methodology

2.1 The RL System Design

In developing and designing the RL packages, this study adopts the Design-Based Research (DBR) framework (Design-Based Research Collective, 2003; Reeves, 2006; Wang, & Hannafin, 2005) and it involves four important iteration phases of design, testing, analysis, and refinement.

For design, the development of the RL system includes identifying the needs of the RL system for science practical work and searching feasible experiments, calibration of sensors, software development, and designing a complete remote-controlled experimental setup for an inquiry science experiment. Hence, several feasible experiments (Table 1) that can be incorporated into the RL system were identified with reference to the local school science curricula. The system includes the Laboratory Virtual Instrument Engineering Workbench (LabVIEW) software which is a graphical programming language that uses icon-based rather than lines of text form to generate programs. It equips with the data acquisition hardware and remote control application through the web publishing tool.

Table 1: The design and content of remote-controlled experiments.

Experiment	Changing Parameter
E1: Sound as vibration	Wave type, sound frequency & volume.
E2: Electrical circuit	Number of bulbs in series & parallel.
E3: Phototropism experiment	Three position of light source & plants horizontal position.
E4: Gravitropism experiment	Plants vertical position at 30° or continuously.

2.2 Evaluation: Testing and analysis

For evaluation, 64 valid undergraduate students in two different courses namely Course 1 (major in a science and web technology programme) and Course 2 (major in a teacher training programme) voluntarily participated in this mixed method research. During their laboratory session, a set of newly developed RL technology-enhanced inquiry activities was conducted by the participants. Based on their learning experiences, self-developed survey questionnaire with four Likert scale and open-ended questions as well as interview were used to collect participants' views, perception and difficulties of using the RL system.

3. Findings, Analysis and Discussion

3.1 RL system

For the RL system, four remote-controlled experiments were successfully developed. Figure 1a presents the design of the RL system for performing remote experiments and Figure 1b shows the webpage for the E4 plant experiment of Gravitropism to be conducted by students. The RL guide and movies for those experiments could be found online at <http://rcl.ied.edu.hk:8000/sample/index.htm> and the webpage also demonstrates how this remote technology is being employed.

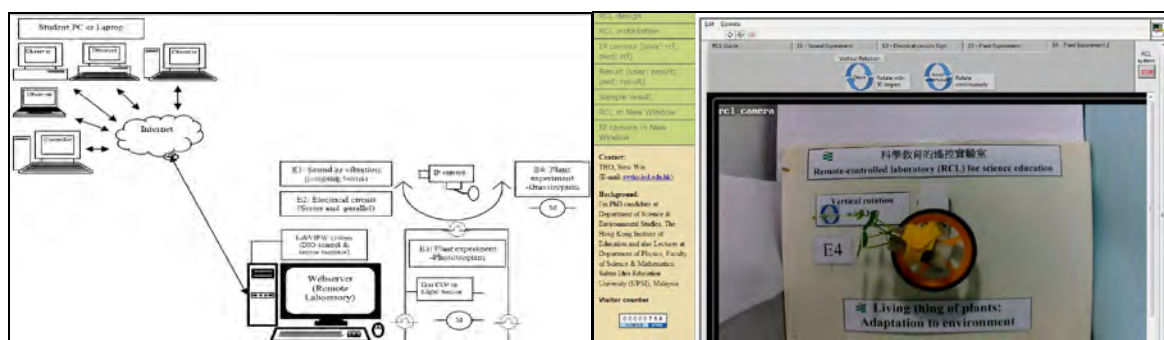

Figure 1. Remote laboratory system: (a) the structure of RL system for performing science experiments; (b) webpage display of the RL system for gravitropism experiment.

3.2 Survey

For this first implementation, we focused our analysis on the undergraduate students' views and suggestions to the RL system refinement before its formal implementation and evaluation in secondary schools. It is because their valuable views and suggestions are very important for us as they learned

science education and teacher training courses. For this reason, no conceptual test was used in this DBR study. Table 2 reports the evaluation data as obtained from the student survey. Overall, the survey findings from all participants showed that they agreed with the educational merits underlying the RL system in the present study. However, Course 2 participants constantly rated higher in the survey items compared to Course 1 participants. Based on open-ended questions and interview data, the comments and suggestions for improvement of the RL system were received.

Table 2: Participants' response on survey items (N=64).

Category	Course 1: mean (SD) (N=30)	Course 2: mean (SD) (N=34)	Overall: mean (SD) (N=64)
Insight of Science & ICT	2.91 (.55)	2.98 (.64)	2.95 (.60)
Operating the RL system	2.90 (.50)	3.06 (.42)	2.98 (.46)
Enriching the learning	2.82 (.89)	3.03 (.59)	2.93 (.75)
Developing application	2.78 (.66)	2.99 (.52)	2.89 (.59)
Stimulating motivation	2.80 (.78)	3.14 (.54)	2.98 (.68)
Improving teaching skills	2.87 (.65)	3.06 (.45)	2.97 (.56)
Promoting group work	2.73 (.73)	2.97 (.57)	2.86 (.66)
Enhancing teaching self-efficacy	2.81 (.67)	2.99 (.45)	2.90 (.56)

3.3 Refinement

Based on analysis, we refined the RL system by using high resolution of IP camera, modifying existing remote experiments and adding new feasible remote experiments (plants respiration, battery bank, and solar energy experiments) as well as providing clearer RL operating guideline.

4. Conclusion

This pilot study has achieved several important outcomes. Initially, the students' perceptions, comments and suggestions of their learning experience with RL system were obtained. Then, the refinement RL system was successfully developed with some innovative application in a few science experiments that can be used inside or outside the school environment to enhance the science learning and complementary to the regular classroom teaching processes.

Acknowledgements

We are very grateful to The Hong Kong Institute of Education for their financial support, particularly the provision of a PhD scholarship to S.W. THO.

References

- Design-Based Research Collective (2003). Design-based research: An emerging paradigm for educational inquiry. *Educational Researcher*, 32(1), 5–8.
- Grober, S., Vetter, M., Eckert, B., & Jodl, H. (2007). Experimenting from a Distance-Remotely Controlled Laboratory (RCL). *European Journal of Physics*, 28(3), 127-141.
- Kong, S. C., Yeung, Y. Y., & Wu, X. (2009). An Experience of Teaching for Learning by Observation: Remote-Controlled Experiments on Electrical Circuits. *Computers & Education*, 52(3), 702-717.
- Lowe, D., Newcombe, P., & Stumpers, B. (2013). Evaluation of the Use of Remote Laboratories for Secondary School Science Education. *Research in Science Education*, 43(3), 1197-1219.
- Reeves, T. (2006). *Design research from a technology perspective*. In Akker, J. V. D., Gravemeijer, K., McKenney, S., & Nieveen, N. (Eds.), *Educational design research* (pp. 52–66). New York: Routledge.
- Wang, F., & Hannafin, M. J. (2005). Design-based research and technology-enhanced learning environments. *Educational Technology Research and Development*, 53(4), 5-23.

The Model Construction and Platform Development of Students' Originality Incubator System

Yunjia Xie^{a*}, Jingya Chen^b, Weipeng Kuang^c

^a*Sun Yat-Sen University, Guangzhou, China*

^b*East China Normal University, Shanghai, China*

^c*Sun Yat-sen University, Guangzhou, China*

*yunjiaxie@sina.com

1. Introduction

The cultivation of technological innovative talents has always been the top priority of countries all over the world. Prior researches have focus on foster students' innovation education by changing governmental strategies or teaching methods (Van Vught, 1989; Shavinina, 2013). Gunnarsdottir (2013) suggested that in innovation education, ideation process is been described as Need-Solution-Products to access their creative. Children gather, analysis and share their needs, solutions and present their products in a learning community environment. With the development of network and information technology, it provides students an easy way to learn and communicate their own ideas in school or outside.

Therefore, this paper is concerned that the originality incubation inner process of undergraduates in a social networking environment, constructed a model of originality incubation system for college students and develop an 'Idea Pool' platform which support the college students' originality generation, development process and formation of learning community. The purpose of 'Idea Pool' is to enhance students' innovative capability by promoting the constant iteration of originality groups in the originality height and knowledge depth, as well as the maturity of originality.

2. Model Construction of Students' Creative Incubator System

This study constructs a model of originality incubation system for college students on the basis of the new concept development theory (NCD theory) which proposed by Koen (2001). The originality incubation system model describes the process of forming feasible originality from the original originality, and it mainly consists of four elements, including the opportunity recognition, opportunity analysis, idea genesis and idea selection. The model is shown in the figure1.

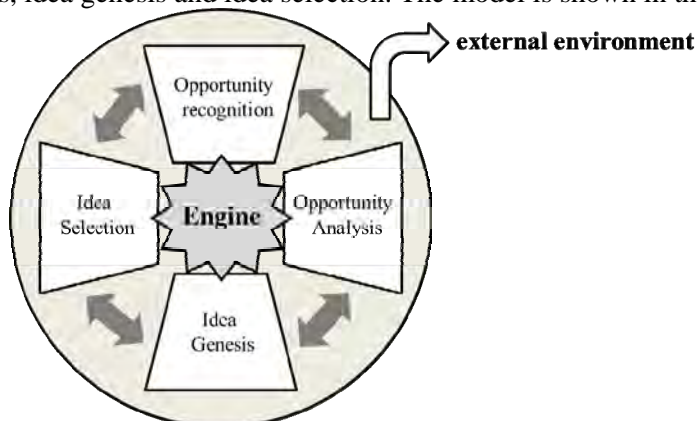

Figure 1. Undergraduate originality incubation model.

The system model mainly consists of the elements, relations, engine and influence of environment on elements.

External environment. During the originality incubation process, environmental factors influencing the creative process mainly consist of the creative atmosphere in campus, strength of the

sponsor of creative activities, strength of the competition group involving in the creative activities, research trend of the creative projects, as well as the technological development.

Engine. Engine is the power that drives the cyclic motion. During the originality incubation process, the communications with peers and teachers, as well as the study of domain knowledge are the main strength of promoting the element cycle in the originality incubation process. In addition, the leadership of group leaders, capacity of group members, collaborative atmosphere of the group, and teacher’s guidance are also of great significance for driving the creative process.

Four internal factors. Until the final feasible creative prototype is formed, these four factors of creative process reflect an iterative loop, rather than the linear relationship. In other words, the creative process has no specific starting point and terminal point. The originality may start at any element or finish at any element. Furthermore, the originality may iterate for several times in one element and then transfer to another element, and it may also iterate among the elements.

3. The framework and function design of ‘Idea Pool’

According to the originality incubation model for undergraduates proposed previously, it can be discovered that the creative process is a random and iterative process, and such a process may be characterized by many chances. During such a process, it may require an open environment for the generation of opportunities, as well as an open environment for promoting the effective communication and the constant maturity of originality, especially in the idea genesis and opportunity recognition two links. ‘Idea Pool’ polish the immature originality into feasible originality by focusing on the accumulation of partners, resources, discussion and relevance. The process of feasible originality generation in ‘Idea Pool’ is shown in the figure2.

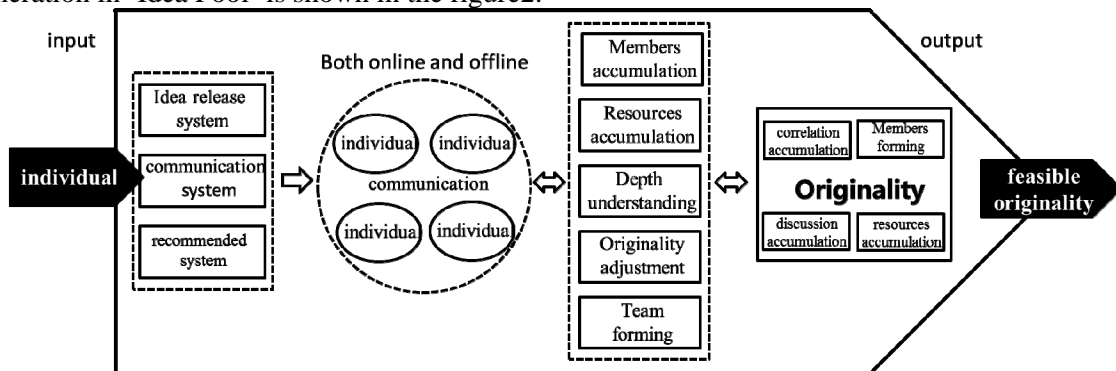

Figure2. The framework of feasible originality generation in ‘Idea Pool’

This platform mainly consists of the following three systems, including the idea release system, communication system and recommended system, and the overall frame diagram is shown in Figure 3.

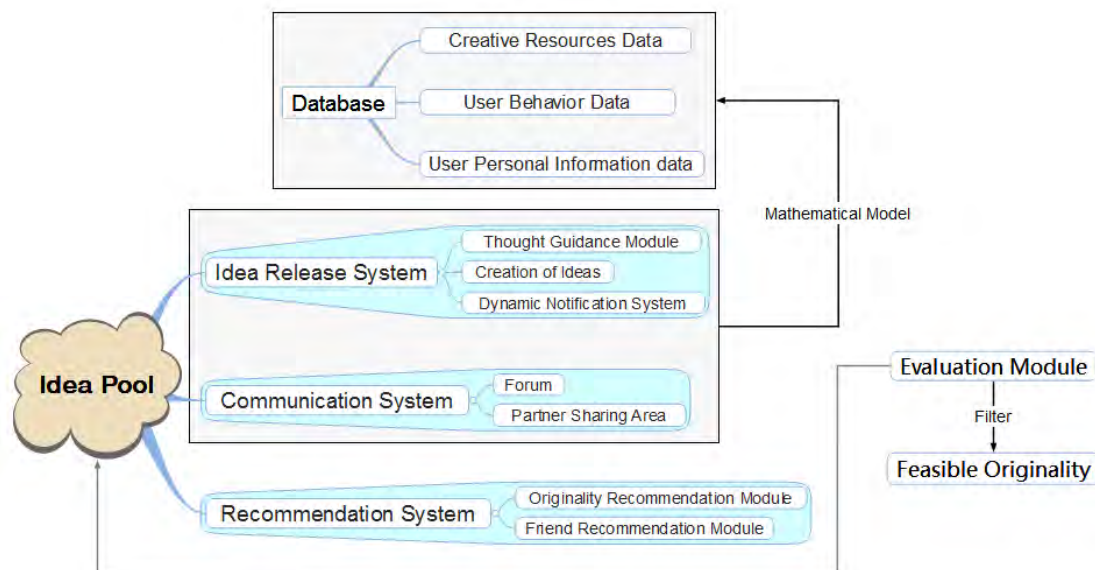

Figure 3. Overall framework of ‘Idea Pool’ educational platform.

In 'Idea Pool', Idea release system sets the template for guiding the thoughts, and provides three problems for clearing the thoughts, namely targeted group, problems that shall be settled, and possible solutions; Communication system consists of the forum and partner sharing area. The design of the forum mainly adopts the classification guide, and users can set up different themes for seminar discussion, including on-line and off-line; Resource recommendation system can extract the key words for the user according to the concern domain they selected and the favorite ideas they labelled before, in order to save time for students, reduces the blindness of searching and improves the efficiency. One of the core interfaces of 'Idea Pool' is shown in Figure 3.



Figure 3. Front page of 'Idea Pool'.

4. Summary

'Idea Pool' mainly takes advantage of the on-line and off-line combined study method to help college students' generating and grinding originality by creating a favorable learning community. At present, the 'Idea Pool' is mainly promoted on campus, forming the network resource links with the originality as the center, so as to connect similar ideas and people with common ideas, and to promote the undergraduates for forming the originality circle.

So far, the 2.0 edition of this platform (Cooperating the action plan of Sun Yat-Sen University) has already been on trial in Sun Yat-Sen University. Till February 2014, the platform has already achieved 10 originalities, and the average originality reliance degree is 28.15%. The data we have collected was not very sufficient, next step we will take more evaluate data into consideration to investigate the usability and usefulness of the system.

References

- Gunnarsdottir, R. (2013). Innovation Education defining the phenomenon. *The Routledge International Handbook of Innovation Education*, 17-28.
- Koen, P., Ajamian, G., Burkart, R., Clamen, A., Davidson, J., DA ´ more, R., Elkins, C., Herald, K., Incorvia, M., Johnson, A., Karol, R., Seibert, R., Slavejkov, A., Wagner, K. (2001). Providing clarity and a common language to the 'fuzzy front end'. *Research-Technology Management*, 44(2), 46-55.
- Shavinina, L. V. (2013). The fundamentals of innovation education. *The Routledge International Handbook of Innovation Education*, 29-51.
- Van Vught, F. A. (1989). Governmental Strategies and Innovation in Higher Education. *Higher Education Policies Series*, 7. Taylor and Francis Group, 1900 Frost Rd., Suite 101, Bristol, PA 19007.

A Flexible System and Data Model for the Representation and Management of PBL Scripts

Disi Wang^{a*}, Yongwu Miao^a, Ulrich Hoppe^a & Mohammed Samaka^b

^a*Department of Computational and Cognitive Sciences, University of Duisburg-Essen, Germany*

^b*Computer Science and Engineering Department, Qatar University, Doha, Qatar*

*wang@collide.info

Abstract: As problem-based learning (PBL) is becoming more and more popular, there is also a growing interest in developing and using technologies in the implementation of PBL. However, teachers may have difficulties to design a pedagogically high-quality and technically executable, online or blended PBL process on their own, because they lack appropriate expertise in learning theories and design methods as well as a deeper understanding of the potential affordances of technologies. From this premise, we are committed to developing and testing methods and tools to support the design and delivery of online or hybrid PBL processes with high flexibility and a low threshold of usage requirements. As a first milestone towards this goal we have developed a web-based PBL authoring tool for facilitating teachers to design, represent, understand, communicate, customize and reuse online or blended PBL processes. This paper presents a technical approach to the PBL authoring tool and focuses on supporting the representation and management of PBL scripts, computational descriptions of PBL process. In comparison with other tools and technical approaches, it is concluded that a combined use of semi-structured data management and a unified data format appears to be a promising approach to effectively and efficiently support the representation and management of PBL scripts.

Keywords: PBL, learning design, PBL authoring tool, PBL script, semi-structured data, data management, graphical representation, web-based application

1. Introduction

Problem Based Learning (PBL) is a learning method to structure the curriculum in such a way as to involve confronting students with problems from practice as a stimulus for learning (Boud & Feletti, 1998). It engages learners in an active, collaborative, student-centered learning process that develops critical thinking, problem-solving, team-work, and self-directed learning abilities needed to meet the challenges of life and career in our increasingly complex environment (Hmelo-Silver & Eberbach, 2012). PBL has been successfully used in various different domains and its benefits have been largely demonstrated (Savery, 2006). The application of new technologies such as Web 2.0 and virtual collaboration environments can enrich and improve implementations of PBL (Kaldoudi et al., 2008). Nevertheless, to achieve its full power, an online or blended PBL process needs to be well designed, and a sound online or blended PBL process may be a collaborative product of years of research, application, assessment and redesign. Usually, designing such a PBL process is an intensively mental work and an implicit process. Traditionally, the teacher individually constructs a PBL design based on personal experience and represents it in natural language as a course plan or lesson plan on paper. Teachers may have neither appropriate expertise in learning theories and design methods nor a deep understanding of the potential affordances of technologies. They lack guidance to design a high-quality and technology-supported PBL plan in a specific context in order to benefit from PBL and new technologies.

Our general goal is to study and develop methods and tools to support the design and delivery of online or hybrid PBL processes in an effective, efficient and flexible manner. As a milestone to achieve this goal we developed a web-based PBL authoring tool that aims at facilitating teachers in design, representation, understanding, communication, customization and reuse of online or blended PBL processes. We try to help teachers to make the implicit design process explicit in order to improve design quality and to represent a traditionally informal description as a formal model for scaffolding

and orchestrating a PBL process by the computer. This paper presents our technical approach to develop a web-based PBL authoring tool. We claim that semi-structured data management and a unified semi-structured data form can make up an effective combination to technically support the representation and management of PBL design.

The rest of the paper is organized as follows: Section 2 describes a typical PBL process script represented in natural language and characterizes a PBL design. Section 3 presents the implementation and the functionalities of the PBL authoring tool to give an impression of our tool. Section 4 identifies technical requirements that how to represent and manage PBL scripts in order to implement the tool. Section 5 compares our tool with related work on the aspects of user interface and data management. The final section summarizes our work and indicates the future work.

2. Requirements to Represent and Manage PBL Scripts

PBL can be conducted in a number of ways. There are different PBL models such as McMasters PBL model (Woods, 1996), the Maastricht “seven jump” model (Barrows, 1996), the Aalborg “Problem Oriented Project Pedagogy (POPP)” model (Dirckinck-Holmfeld, 2002), Mills “five-stage” model (Mills, 2006), and SALFORD model (McLoughlin & Davrill, 2007). According to concrete situations such as the learners’ prior domain knowledge and PBL skills, the topics to be learned and the problem used to drive learning, and the availability of learning technologies, a PBL process can be designed to fit the specific learning context. In order to illustrate how a PBL process is usually described informally in natural language, we take a segment of “seven-jump” model as an example through this paper from (Maurer and Neuhold, 2012):

“To get students started on a certain topic, they are confronted with an assignment that ... outlining the problem or asking for a specific task to complete. ... Students are supposed to have read and looked at this assignment already before their tutorial (or during the break), so that they can start with **clarifying terms and concepts**. This first step guides students mentally into the topic, and by discussing unknown words or concepts it is ensured that all students understand the text as it stands and that the group shares ideas about illustrations that might be part of the assignment. This first step provides a common starting point and leads the group into the topic. In the next step, the whole group agrees on the **formulation of the problem statement** that frames the whole assignment, provides a title for the session, and makes the group agree on what the general impetus of the assignment is about. Problem statements can take the form of more traditional titles, but are sometimes also formulated as broader research questions or provoking statements. The problem statement should trigger the next step of the **brainstorm**. ... Everything is allowed during this step, and ideas are collected unquestioned at the whiteboard (i.e. there are no wrong ideas; everyone should be allowed to follow her/his own ideas). ... The outcome of the brainstorm is noted on the whiteboard by the secretary that during the next (fourth) step should be **categorized and structured** by the students. ... but by structuring the brainstorm students categorize keywords that fit together and in this way they find common patterns that in the next step will allow for the formulation of specific questions. As last step of the pre-discussion, students agree on the **formulation of common learning objectives**, by referring to the brainstorm and the now structured collection of ideas that they have noted on the whiteboard. ...”

This PBL model consists of several steps (marked in bold, here only shows five steps for the reason of space) which includes *clarifying terms and concepts*, *formulation of the problem statement*, *idea brainstorming*, *categorizing and structuring ideas*, and *formulation of learning objectives*, etc. In each step one or several activities are performed by the facilitator, group, individual learner or stakeholders, e.g. scientific staff. For instance, according to the quoted text, after a problem statement was formulated in step 2, the third step *idea brainstorming* will be triggered. Assume that this learning model will be performed by a class which is divided into 3 groups and instructed by one facilitator, then in this step, a specific activity sequence could be 1) based on the problem statement formulated in the previous step, each group creates a basic hypothesis; 2) from this basic hypothesis each group proposes their tentative solution; 3) the facilitator views these solutions and give his or her feedback. Each group will improve their tentative solutions based on the feedback. In this step, there are some artifacts will be produced: three groups of basic hypotheses, three groups of tentative solutions and the facilitator’s

feedback. All this work could be carried out by using an (online) whiteboard. Figure 1 illustrates the process above.

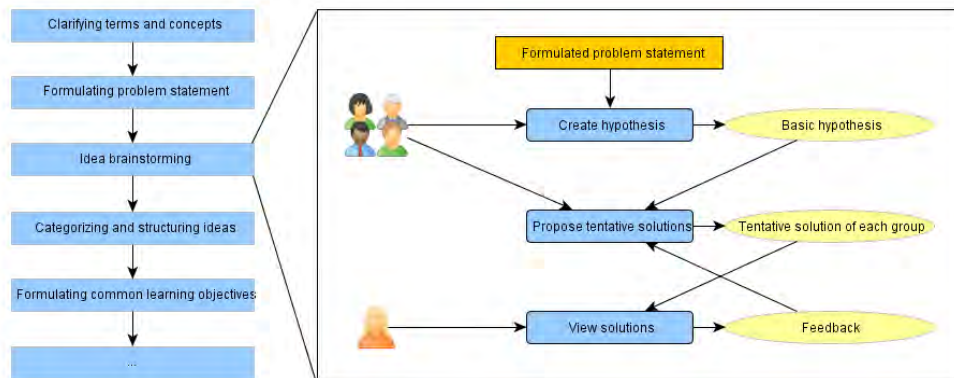

Figure 1. Structure demonstration of a PBL process.

As it is shown in the figure 1, there are several top level steps in the left, which is also called phases. The phases have a process sequence from top to bottom. Then in each phase, *idea brainstorming* for instance, there is a second level of description, or phase internal definition. Teacher needs to organize actors first and then assign actors to different activities. Some activities will produce artifacts or need learning resources. The activities are also under a process sequence.

Existing ICT applications for PBL still lack flexibility and usability/understandability by teachers who are not PBL experts. Either some applications are easy to use because they have well-designed PBL process pattern inside, e.g. STELLAR (Hmelo-Silver et al., 2009) and ePBL (Ali & Samaka, 2013), but too rigid to apply different PBL models; or some applications are flexible enough, but difficult for teachers who lack a deep understanding of PBL processes. For example, teachers need to figure out which activities are appropriate for a certain phase; what kinds of artifacts should be there as temporary outcome or final outcome for certain phase and so on. Since process scripts are usually just embedded in teacher's practice and they tend to be implicit. Thus in educational practice, PBL processes mostly are executed only based on a social protocol and a manual configuration and management of various application tools and digital or non-digital artifacts. As a consequence, there is a need to support teachers in representing PBL processes more explicitly and formally.

In order to overcome these barriers and to enable computerized support of different models of online PBL, one possible way is to adopt the concept of CSCL script. As we know, this concept has been used to structure computer supported collaboration (Dillenbourg, 2002). It has been considered an effective means of facilitating specific interaction patterns in CSCL situations (Fischer et al., 2007). Numerous approaches to representing CSCL scripts and CSCL scripting languages have been reported in the literature (e.g. Dillenbourg, 2002; Miao et al., 2005; Miao et al., 2007; Dillenbourg & Tchounikine, 2007; Harrer et. al. 2007). Our approach is particularly inspired by Miao et. al. (2000), and we proposed our PBL specific scripting language, namely PBL scripting language. Rather than using generic vocabularies, our scripting language only relies concepts that teachers use daily to describe PBL processes such as *problem engagement*, *identify learning issue*, *generate solutions*, *evaluate acquired knowledge*, etc. Also, as a kind of Domain Specific Modeling Language (DSML), these vocabularies and rules are specified by PBL domain experts taking into account different PBL models. In this way, teachers can be enabled to make use of different PBL models to create different but correct and computer understandable PBL scripts. As a result, teachers' mental scripts become representable, manageable and runnable online or as blended PBL course plans.

Therefore, there is a requirement to find a way of providing a web-based application which is aimed at empowering teachers to represent, improve, understand, share, reuse and manage online or blended PBL scripts in a design-time basing on the applying of our PBL scripting language.

3. A Web-based PBL Authoring Tool

In order to fulfill the requirement mentioned above, we have developed a web-based PBL authoring tool whose basic concept has already been introduced and evaluated. Miao et al. (2013) provide evidence that this tool is understandable and usable by teachers to develop online PBL course plans. Taking up the example in section 2, figure 2 shows the three major User Interface elements of this tool. They separately represent the organization design UI, the script level design UI and the phase level design UI. The most important functional area is the middle area which contains, from left to right, 1) script file management panel (for scripts management, sharing, reusing, etc.), 2) meta-type pool (which provides corresponding meta-types for different types of edit-spaces according to the PBL scripting language meta-model), 3) graphical script edit-space and 4) property panel.

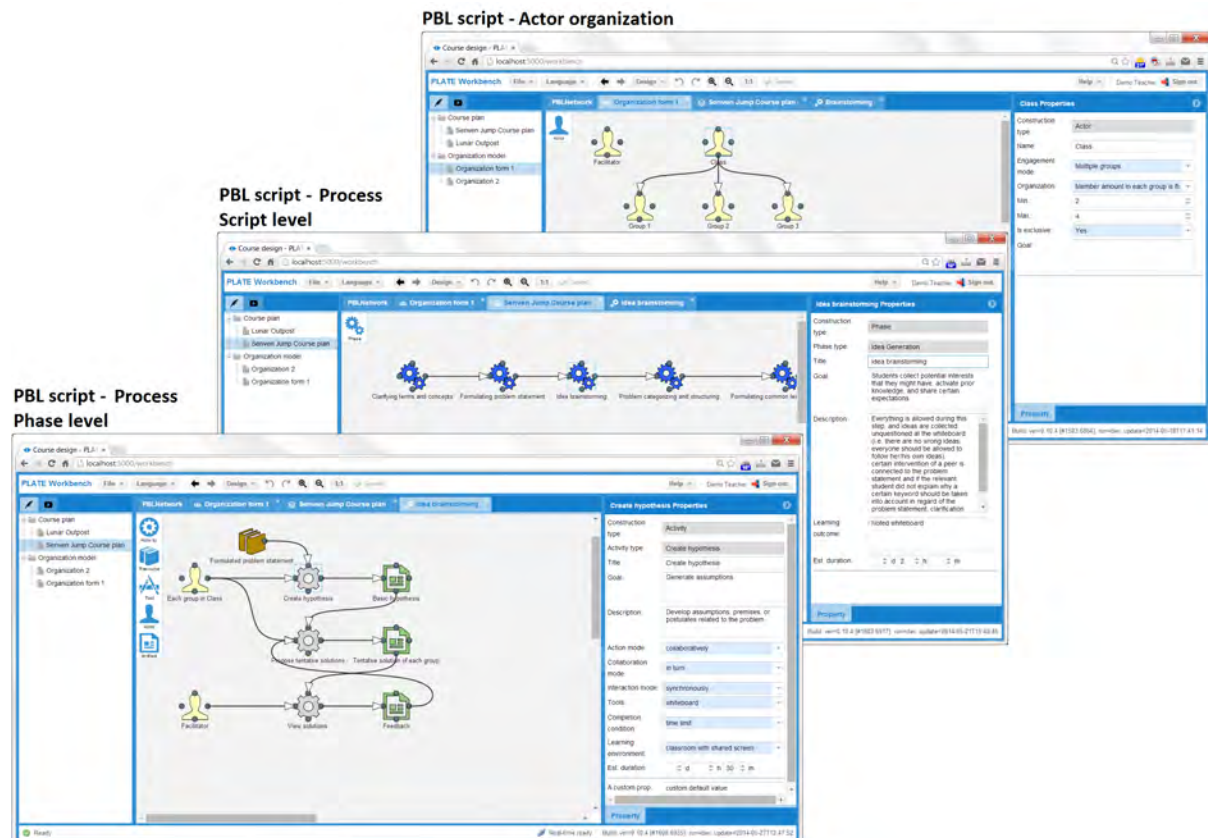

Figure 2. User interfaces of actor organization design, script level design and phase level design of PBL script in the PBL authoring tool.

Specifically, in the organization design, teacher can drag the *actor* meta-type icon from the meta-type pool and then drop it into the edit-space to create an actor node. Then the teacher will be asked to determine its type. This ensures that the node is appropriate for correct PBL process as well as can be understood by computer. According to the definition of PBL scripting language the type of actor could and only could be an *individual*, a *single group* or *multiple groups*. Teacher just needs to choose one to define it. For example in the organization design UI, an *individual* node is created and named as *Facilitator*, a *multiple groups* node is created and named as *Class* (in the property panel we can see the minimum participants of each group is 2, maximum is 4, and so further). Teacher can also create connections between them to define their relations. The organization can be shared by multiple PBL processes.

After an organization is defined, teacher can begin to define the core part of a PBL process: script level process and phase level process. Almost the same to the way of designing organization, teacher can also simply by dragging, dropping, choosing, editing properties, connecting, etc. to design these two levels of process. But compared to the organization design, there are 3 other important points need to be emphasized. 1) There are more meta-types which include *phase*, *activity*, *resource*, *tool* and *artifact* generated according to our language meta-model to the meta-type pool while in the organization design there is only *actor*. Actually, the process of creating these types (including *actor*) of nodes on the edit-space is the process of instantiating node types defined in the language meta-model to

node instances. In other words, teacher just needs to instantiate the meta-types instead of designing from scratch by themselves. This mechanism ensures that the design of script is both flexible and responsible (Wang et al., 2014). As it is shown in the script level UI of figure 2, the node *Idea brainstorming* is based on the type *Idea Generation*. *Idea Generation* is not defined by teacher but by expert. So that when teacher designs the internal structure of the *Idea brainstorming* node (phase level design), all available node types and nodes' properties under this phase are only the appropriate types and properties for this phase according to the meta-model's specification. For example, when teacher wants to create an activity, the only options are *Offer conjecture*, *Create hypothesis*, *Propose tentative solutions*, etc. Or when teacher wants to create an artifact, only *Hypothesis*, *Solution*, etc. can be chosen. Inappropriate node definition will be avoided. 2) The types of actor node are the nodes defined in actor organization, but with corresponding extension. For example, since there is a *multiple groups* type node *Class* created, when teacher drags an actor into the edit-space, a list which contains *All members in Class*, *Each member in Class*, *All groups in Class* and *Each group in Class* will be generated for choosing. So in the phase level design UI, an *Each group in Class* actor node is there as an example. Connected this node, there is a *Create hypothesis* node. In property panel of this node, for example, teacher can choose *collaboratively* as the *Class' Action mode*, and let each group *in turn* perform the activity. Each group will *synchronously* use *whiteboard* to generate their *Basic hypothesis* within *30 minutes*. 3) Except there are fixed properties for each node in the script and phase design level, it is possible to add new custom properties into the property panel, because the property requirement in real world is always uncertain. As you can see there is an *A custom prop.* at the bottom line in the property panel in the PBL phase level design UI. It is achieved through extending our scripting language meta-model by experts, rendered in the script design UI, which is used to save, retrieve more information to get higher expression ability.

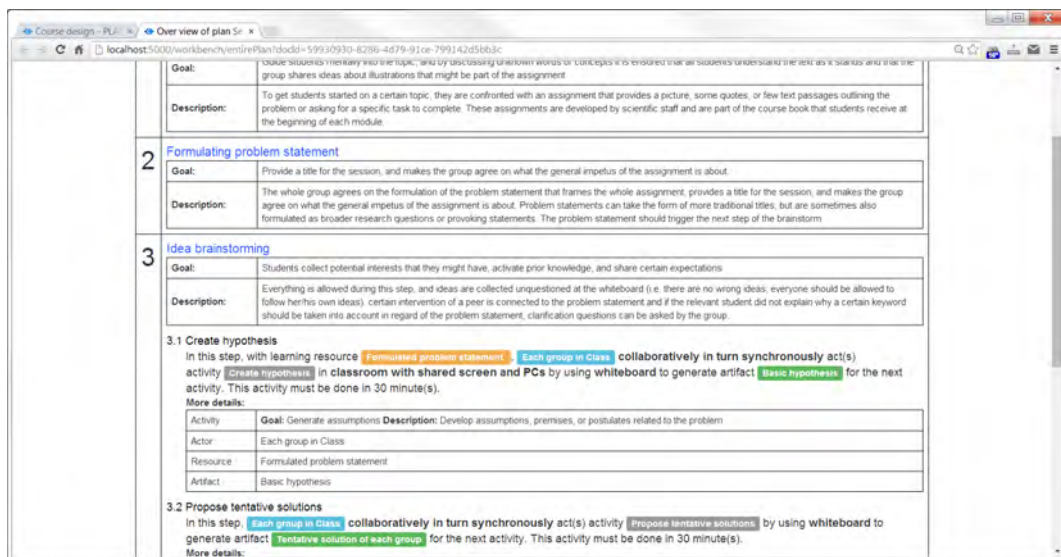

Figure 3. The textual output of the graphical designed PBL script.

When teacher finishes his or her design, a graphical PBL script can be exported as a complete textual script. Figure 3 shows the textual output of the example used in figure 2. Notice that if the teacher did not specify the *Goal* or *Description*, etc. the tool will automatically generate a default general definition based on the language meta-model and the node type chosen by the teacher at design-time. In this output, the top level contains the phases; then each phase contains activities (for saving space and as an example, there is no internal definition in phase 1 and 2). In phase 3, *Idea brainstorming*, we can see the activities inside. A summary generated by the tool for each activity according to which *actor*, *resource*, *artifact*, etc. it connects and what property values are set. For example the generated summary of activity 3.1 *Create hypothesis* is: "In this step, with learning resource *Formulated problem statement*, *Each group in Class* collaboratively in turn synchronously act(s) activity *Create hypothesis* in classroom with shared screen and PCs by using whiteboard to generate artifact *Basic hypothesis* for the next activity. This activity must be done in 30 minute(s). "

This proves that the tool has already understood what the teacher’s script means. So interoperating the graphical script for other run-time learning systems, e.g. IMS-LD players, becomes possible.

4. An Approach of Supporting the Representation and Management of PBL Scripts

The previous section has given an initial impression of our approach. But to actually implement it, several technical problems need to be overcome: 1) How to support this kind of unified manner to represent actor organizations and the processes? Because the heights of the script document tree could be greater than 1 or 2 as the example. The degrees of the sub-trees could also be greater than 5, 7 or 9 as the example. 2) How to effectively manage (save, retrieve and compute) the graphical scripts? The saving/retrieval includes saving/retrieving all the nodes, saving/retrieving (custom) properties of every node, saving/retrieving all the relations between the nodes, saving/retrieving the multi-levels structure; the computing includes transforming graphical scripts to complete textual documents. This section will present a flexible system and data model approach to overcome these problems.

4.1 The Implementation Concept

Although the multi-levels structure of a PBL script is semi-structured, which has uncertain height and degree, it has a special hierarchical characteristic. That is, different level is for definition, same level is for relation. For example, the script level is the general process definition of a script divided by phases; the phase level is the detailed definition of each phase. In contrast, the script level defines the relations between phases; the phase level defines the relations among activities, actors, etc. Similar, if one wants to give more fine-grained definition for the *Class*, one can also define a lower level for it. Therefore, the edit-space can be designed to support the design of a whole PBL process iteratively. Each edit-space represents the definition of only one upper layer node. Each definition is a directed graph that consists of nodes and connections. Figure 4 illustrates this kind of iterative representation from two aspects. The edit-space 1 is for designing the phase’s sequence for example. After a phase was defined it can be opened into a new edit-space. Similar to the first, in the edit-space 2, activities, resources, tools, actors, artifacts and their relations can be defined. If required, a third level of edit-space can be opened. Therefore a process script even if with infinite height and degree can be defined. Since manipulation requirement of each level is similar, the functionalities required for each edit-space are similar too.

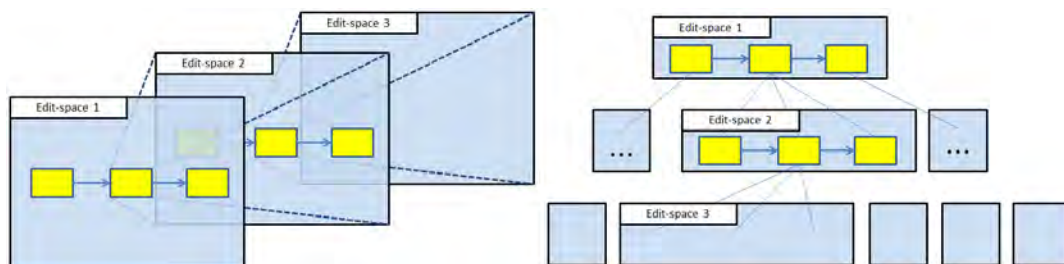

Figure 4. Iterative representation concept of a PBL process in multi-level edit-spaces

Actually, database can be also designed to save the definitions in each edit-space iteratively in order to save infinite height and degree of PBL scripts. Because there are only finite meta-types of nodes in the PBL scripting language, which only includes *phase*, *activity*, *resource*, *tool*, *actor* and *artifact*, and nodes in edit-space are just the instances of those meta-types, all nodes can be iteratively saved in their own meta-types of collections. Relation connections among nodes are seen as connection type instances which can be saved in a connection collection. Figure 5 illustrates this kind of storage approach. Each node has a *definition id* field as a pointer points to another edit-space; each edit-space has a *segment id* to let the nodes or connections know where they locate. Nodes and connections of different edit-spaces from different scripts are scattered stored in their own meta-types of collections.

The retrieval of a definition is just to find all the nodes and connections where their *segment ids* equal to the edit-space’s *segment id*. Then the data can be directly sent to client side without any logical calculation. Basing on their graphic coordinate values all nodes and connects will be correctly rendered

on edit-space. Because the nodes and connections as minimum units are stored separately, it shows several benefits: 1) It is very effective to add, remove, update and find node whenever where it is in one or many PBL scripts. When teacher edits a node or connection, any change can be saved without involving any other nodes or connections. So high computation cost in updating script is avoided. 2) It is very easy to handle the change of process structure. Because the node definitions are not really connected to each other, the change of structure only needs to change the pointer value. This benefit make it is possible to effectively reuse and share any levels of sub-trees of any script. When teacher wants to view the complete script, all nodes and connections can be easily retrieved because all of them whom belongs one complete script have a same *script id*. The only additional thing is that before a complete script is sent back to client, a semantic engine will organize them into a correct order.

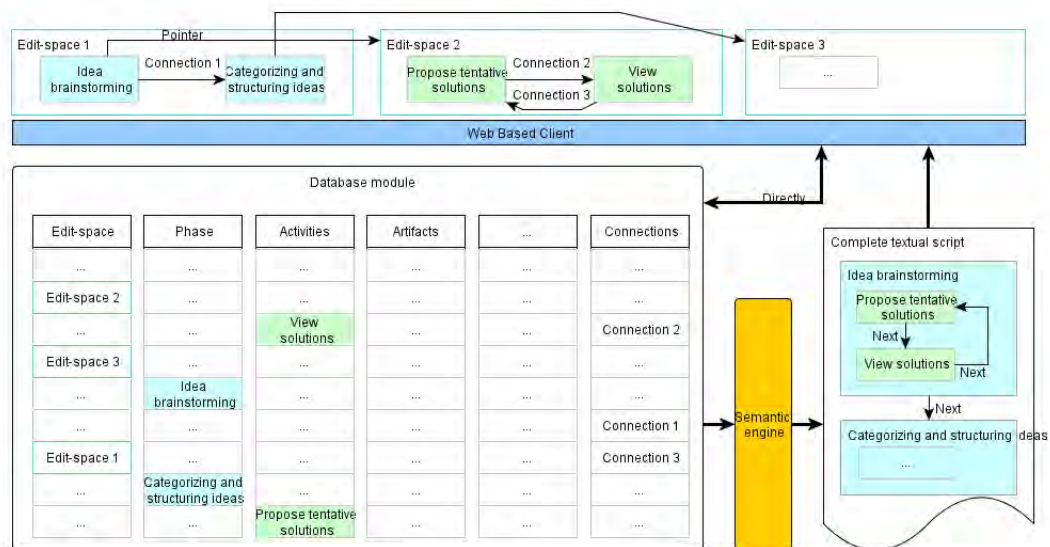

Figure 5. The storage concept of the PBL script

4.2 Combined Use of Semi-structured Data and Unified Data Format

The previous section has elaborated the implementation concept of representing and managing the semi-structured script data, but to technically implement it is another challenge. The following facts must be considered: 1) Not only the structure itself of PBL script is semi-structured, but also the node data itself is semi-structured. For example, as mentioned before, node can have custom fields. The data type of a field could be string, array or others. Figure 6 shows this characteristic. In comparison to activity *Propose tentative solutions*, the custom fields of activity *View solutions* may be more complicated, if it needs an array to store the values for a drop-down list of a combo box. 2) As a web-based application, to maximally avoid browser compatibility issues, we need to use pure JavaScript to develop the rich graphical client.

Because the Node.js can be chosen as our web server, we can use JavaScript to program both client side and server side. Figure 7 shows the system architecture from the perspective of data handling. Since the client side and sever side of the system are both built by using JavaScript and JSON is the object notation of JavaScript; also because we can use MongoDB as our system database and the data persistence format in MongoDB is JSON (or BSON¹), the data interchange format inside the whole system can be unified as JSON object. As we know, JSON is an ideal data-interchange language for representing semi-structured data. Therefore the node/connection objects in the system could be simply as JSON objects. Consequently, on the one hand, client side and server side can communicate each other directly through JSON object (after serialization). In client side, nodes and connections can be directly rendered to edit-space or sent back to server side without any format transformation. Also without any transformation, server side can directly process the nodes or connections from client side. On the other hand, data from client side can be stored inside the database directly. Even if there are new

¹ Short for Binary JSON, is a binary-encoded serialization of JSON-like documents.

custom attributes, such as string or array fields, which are customized added, client and server side JavaScript interpreter and MongoDB can still handle and store them natively.

Together with using pure JavaScript for the client UI, Node.js as the web server and MongoDB for the data persistence, JSON becomes a natural choice as a unified data format in our whole system. Combined with the implementation concept for handling the semi-structured process descriptions, all the requirements for the representation and management of PBL scripts are met.

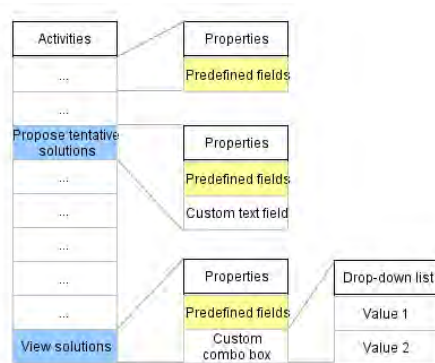

Figure 6. Custom property in node

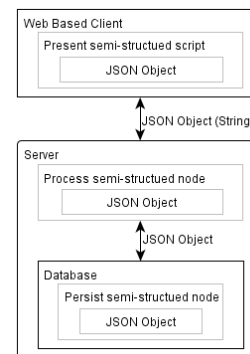

Figure 7. System architecture from the perspective of data handling

5. Related Work

Generally speaking, currently there are two kinds of implementation that can flexibly support PBL design: IMS-LD authoring tools and the LAMS (Dalziel, 2003). For IMS-LD authoring tools, there are Reload (Reload 2005), MOT+ (Paquette, et. al, 2006), ASK-LDT (Karampiperis & Sampson, 2005) CopperAuthor (CopperAuthor 2005) and CoSMoS (Miao, 2005). These tools are very flexible to represent and support the design of different learning process models and output the models as Unit of Learning (UoL) packages. The packages can be interpreted by IMS-LD run-time applications, such as CopperCore player (Martens & Vogten, 2005) and SLED (McAndrew, Nadolski & Little 2005). All these tools are general learning design tools; they have the capability of supporting PBL design. For the LAMS, a study has shown that it also can be used for PBL design (Richards & Cameron, 2008).

However, all of them have some shortcomings in term of supporting PBL design. From the perspective of supporting visual learning design, IMS-LD authoring tools and LAMS misses the capability of facilitating teachers in developing sound PBL process since they are too general and not PBL domain specific. From the perspective of utilizing Web technologies, these tools came about by adopting traditional software development concept, most of them are desktop applications. As we know, desktop applications have high maintenance cost, are not anywhere available without pre-installation, are not cross-platform (if they are not on the top of Java) and so further. From the perspective of data management approach, existing applications store learning design artifacts either by using traditional relational database or directly as XML files. Relational databases are good at data storage and querying, but they cannot manage this kind of semi-structured data well since they are relational and not schema free. XML file is a kind of ideal media for storing this kind of semi-structured data; one drawback is that it is not ideal for data manipulation, such as partial update, search, etc. which will lead to considerable computational overhead in server side. Although there are some combination solutions to manage XML documents through relational database, XML queries are still inefficient (Shanmugasundaram, et. al. 2008).

6. Summary and Future Work

PBL is a kind of high collaborative learning process with a distinctive pedagogy, therefore there are difficulties in designing the process script, which include designing actor organization and designing learning process. Thus an extended CSCL scripting language, the PBL scripting language, is developed.

To ease the applying of the language in Web 2.0 era, we developed a web-based PBL authoring tool to provide a rich and intuitive representation for helping design any kind of PBL scripts of any kind of models. Our former pilot study (Miao et al., 2013) has shown that the difficulties to design and delivery pedagogically high-quality, human readable, reusable, sharable and computer-executable, online or blended PBL process are reduced as intended. Our tool has been implemented based on the premise that there are two common dimensions of semi-structured characteristics inside PBL scripts. One is from the point of view of the scripts; the other is from the point of view of a single node/connection inside scripts. From the first dimension, if we see a script document tree from root to leaf, the sibling nodes and relations are the definitions of its upper level parent node. That is, nodes (connections) are used to define node; if we only focus on one sibling level, horizontally it is just about the definition of the relations among the sibling nodes. The sibling nodes do not define each other. So by iteratively doing these two things, any PBL script can be defined, regardless how complicated an organization or a learning process is. From the second dimension, we use JSON as a unified data process and storage format. Since JSON format is designed to represent semi-structured data, the uncertainty of node's or connection's structure can be processed. In order to effectively implement these two dimensions of design as a web-based application, we use JavaScript to program both client side and server side. In case of storing and retrieving the JSON data, we use MongoDB as database, so that all the semi-structured characteristics of the two dimensions can be effectively handled. At last we also discussed some other related work. In term of user interface and data management, other work more or less has their drawbacks. Therefore we conclude that a combined use of semi-structured data management and a unified data format appears to be a promising approach to effectively and efficiently support the representation and management of PBL scripts.

This paper illustrates an approach to design and implement a web based authoring tool to help teachers represent and manage their PBL mental scripts as graphical scripts. And then the graphical scripts can be transformed into textual scripts or learning systems executable scripts. Our future work includes two directions: one is to make these transformation steps automatically. That is, extract process directly from existing semi-structured textual scripts, and then store them in system, represent them by our graphical user interface and transform them to other learning systems; the other is to develop our own specific PBL run-time learning environment, so that we can provide an integrated way to test and run the PBL scripts for both teachers and learners.

Acknowledgement

This paper was made possible by NPRP grant # NPRP 5-051-1-015 from the Qatar National Research Fund (a member of Qatar Foundation). The statements made herein are solely the responsibility of the authors.

References

- Ali, Z., & Samaka, M. (2013). "ePBL: Design and Implementation of a Problem-based Learning Environment," Proc. of 2013 IEEE Global Engineering Education Conference (EDUCON), 1209-1216, Berlin, Germany.
- Barrows, H. S. (1996). Problem-based learning in medicine and beyond. In L. Wilkerson & W. H. Gijsselaers (Eds.), *New directions for teaching and learning: Vol. 68. Bringing problem-based learning to higher education: Theory and practice* (pp. 3-13). San Francisco: Jossey-Bass.
- Boud, D., & Feletti, G. (1998). The challenge of problem-based learning. London: Kogan Page.
- CopperAuthor (2005). CopperAuthor Learning Design editor, retrieved October 27, 2005 from <http://sourceforge.net/projects/copperauthor/>.
- Dalziel, J.R. (2003). Implementing learning design: the Learning Activity Management System (LAMS), Interact, Integrate, Impact, 593-6, *Proceedings of the ASCILITE conference*. Available online at: <http://www.ascilite.org.au/conferences/adelaide03/docs/pdf/593.pdf>, last accessed 25 May 2014.
- Dillenbourg, P. (2002). Over-scripting CSCL: The risks of blending collaborative learning with instructional design. In P. A. Kirschner (Ed.), *Three worlds of CSCL: Can we support CSCL?* (pp. 61-91). Heerlen, The Netherlands: Open Universiteit Nederland.
- Dillenbourg, P., & Tchounikine, P. (2007). Flexibility in macro-scripts for computer-supported collaborative learning. *Journal of Computer Assisted Learning*, 23, 1-13.

- Dirckinck-Holmfeld, L. (2002). Designing Virtual Learning Environments Based on Problem Oriented Project Pedagogy. In L. & Dirckinck-Holmfeld & B. Fibiger (Eds.), *Learning in Virtual Environments* (pp. 31-54). Frederiksberg C: Samfundslitteratur Press.
- Fischer, F., Kollar I., Mandl, H., & Haake, H. M. (2007). Scripting computer-supported collaborative learning: Cognitive, computational and educational perspectives. New York: Springer.
- Harrer, A., Malzahn, N., & Hoppe, U. (2007). "Graphical Modeling and Simulation of Learning Designs, Supporting Learning Flow through Integrative Technologies," in T. Hirashima and U. Hoppe and S. Young eds. *Frontiers in Artificial Intelligence and Applications*, Vol. 162. IOS Press, Amsterdam.
- Hmelo-Silver, C.E., & Eberbach, C. (2012). Learning theories and problem-based learning. In S. Bridges, C. McGrath, & T. Whitehill Eds. *Researching problem-based learning in clinical education: The next generation*, pp. 3-17, New York: Springer.
- Hmelo-Silver, C.E., Derry, S.J., Bitterman, A., & Hatrak, N. (2009). Targeting Transfer in a STELLAR PBL Course for Preservice Teachers, *The Interdisciplinary Journal of Problem-based Learning*, 3(2), 24-42.
- Kaldoudi, E., Bamidis, P., Papaioakeim, M., Vargemezis, V. (2008). Problem-Based Learning via Web 2.0 Technologies. *21st IEEE International Symposium on Computer-Based Medical Systems*, pp.391-396.
- Karamperis, P., & Sampson, D. (2005). Designing learning services for open learning systems utilizing Learning Design. In Uskov, V. (Ed.) *Proceedings of the 4th IASTED International Conference on Web-based Education*, Grindelwald, Switzerland: ACTA Press, 279-284.
- Martens, H., & Vogten, H. (2005). A reference implementation of a Learning Design engine. In: Koper, R. & Tattersall, C., *Learning Design: A Handbook on Modelling and Delivering Networked Education and Training* (pp. 91-108). Berlin-Heidelberg: Springer Verlag.
- Maurer, H., & Neuhold, C. (2012). "Ways of Knowing, Ways of Learning". Paper prepared for the Higher Education Academy Social Science Conference, 28 - 29 May, 2012, Liverpool, UK.
- McAndrew, P., Nadolski, R., & Little, A. (2005). Developing an approach for Learning Design Players. *Journal of Interactive Media in Education*, 2005/14. Retrieved November 21, 2006, from <http://www.jime.open.ac.uk/2005/14/>.
- McLoughlin, M., & Davrill, A. (2007) Peeling back the layers of learning: A classroom model for problem-based learning, in *Nurse Education Today*, 27(4), May 2007, Pages 271-277.
- Miao, Y. (2005). CoSMoS: Facilitating Learning Designers to Author Units of Learning Using LD. In: *Towards Sustainable and Scalable Educational Innovations Informed by the Learning Sciences, Proceedings of the 13th International Conference on Computers in Education*, 275-282, Singapore, IOS Press.
- Miao, Y., Harrer, H., Hoeksema, K., & Hoppe, U. (2007b) "Modelling CSCL Scripts: A Reflection on Learning Design Approaches". a book chapter in Fischer, F., Kollar, I., Mandl, H., & Haake, J.M. (Eds.) *Scripting Computer-Supported Collaborative Learning: Cognitive, Computational and Educational Perspectives*, 117-135, Springer.
- Miao, Y., Hoeksema, K., Harrer, A. and Hoppe, U., (2005). CSCL Scripts: Modeling Features and Potential Use. *Proceedings of Computer Supported Collaborative Learning (CSCL' 05) conference*, pp. 423-432, May 30 – June 4, 2005, Taipei, Taiwan.
- Miao, Y., Holst, S., Haake, J.M., & Steinmetz, R. (2000b). PBL-protocols: Guiding and Controlling Problem Based Learning Processes in Virtual Learning Environments. In: *Proceedings of the Fourth International Conference on the Learning Sciences (ICLS' 2000)*, pp. 232-237. June 14-17, 2000, Ann Arbor, U.S.A.
- Miao, Y., Samaka, M., & Impagliazzo. (2013). Facilitating Teachers in Developing Online PBL Courses, *Proc. IEEE TALE*, Bali, Kuta, Indonesia, August 26-29 2013, pp. 454-459.
- Mills, D. (2006). Problem-based learning. *The Higher Education Academy, Sociology, Anthropology, Politics (C-SAP)*.
- Paquette, G., Léonard, M., Ludgren-Cayrol, K., Mihaila, S., & Gareau, D. (2006). Learning Design based on Graphical Modelling. *Educational Technology & Society*, 9(1), p. 97-112.
- Reload (2005). Reusable e-Learning Object Authoring & Delivery Project, retrieved on October 27, 2005 from <http://www.reload.ac.uk/>.
- Richards, D., & Cameron, L. (2008). Applying Learning Design concepts to problem-based learning In L. Cameron & J. Dalziel (Eds), *Proceedings of the 3rd International LAMS & Learning Design Conference 2008: Perspectives on Learning Design*. (p.p. 87-96). 5th December 2008, Sydney: LAMS Foundation.
- Savery, J. R. (2006). Overview of problem-based learning: Definitions and distinctions. *Interdisciplinary Journal of Problem-based Learning*, 1, 9-20.
- Shanmugasundaram, J., Tufte, K., He, G., Zhang, C., DeWitt, D., & Naughton, J. (2008). Relational databases for querying xml documents: Limitations and opportunities.
- Wang, D., Miao, Y., Hoppe, U. and Samaka, M., A Domain-specific Modeling Language Approach to Support Various Forms of Online PBL, In *Proceedings of the 14th IEEE International Conference on Advanced Learning Technologies - ICALT2014*, July 7-9, 2014, Athens, Greece.
- Woods, D. R. (1996). Problem-based learning for large classes in engineering education. *Bringing problem-based learning to higher education*. L. Wilkerson and H. Gijsselaers. San Francisco, CA, Jossey-Bass: 91-99.

Algorithmic Thinking Learning Support System in Block Programming Paradigm

Mizue KAYAMA^{a*}, Hisayoshi KUNIMUNE^a, Masaaki NIIMURA^a, Masami HASHIMOTO^a &
Makoto OTANI^a

^a*Shinshu University, Japan*

*kayama@cs.shinshu-u.ac.jp

Abstract: The goal of this study is to develop a learning support system for algorithmic thinking for novices. This paper describes some educational functions of this system. The main features of this system are 1) the teacher can control the usage of control elements for developing algorithms based on his educational philosophy, 2) a simple task-answer management system is included and 3) eAssessment functions based on the Student-Problem table method are implemented.

Keywords: Algorithmic thinking, education for beginners, student-problem score table analysis, problem reviewing.

1. Introduction

An algorithm is defined as “... a set of rules that precisely defines a sequence of operations such that each rule is effective and definite and such that the sequence terminates in a finite time”[Stone 1972, Knuth 1980]. As such, until recently, algorithms have been taught in programming courses. However, since about five years ago, algorithms have been taught before programming. There have been many papers on this kind of algorithm and/or algorithmic thinking education, e.g., Sarawagi 2010, Hubalovsky 2010, Futschek 2011.

We have proposed an educational method for algorithmic thinking in fundamental education for computer science course students in 2008[Fuwa 2009] and examined the effectiveness of our algorithmic thinking learning support system. We designed our system based on discovery learning[Bruner 1960] and guided discovery[Cook 1991]. This system uses only three flow structure elements: calculation, selection and repetition. Students describe the algorithm using these three elements.

“What kinds of problems are suitable for assessing the students’ ability and evaluating achievement level?” This is our research question. To review some typical exercise questions, we introduce the Student-Problem (SP) Score Table Analysis method. This paper describes educational functions in our algorithmic thinking system and our eAssessment function.

2. Brief Description of Our Learning System

2.1 Educational Features

We have developed a web based learning system for basic algorithmic thinking education[Kayama 2014a]. This system has the following pedagogical features:

1. The algorithm is represented not by a flow chart, but by columns of blocks such as stacks that grow downward.
2. Input errors can be reduced.
3. The rules to describe the algorithm can be increased in pedagogical stages.

Feature 1 makes learners concentrate on block combinations without thinking about notation. Each block corresponds to all the elements for constructing the algorithm. Learners can insert, move or delete the blocks with their mouse.

To realize feature 2, the variables only need to be typed once. After that, they can be selected from a list. Only operations that are allowed can be selected from a list.

Feature 3 allows control of the blocks visible in proportion to the learner's learning progress. This makes learners think about the algorithm in a situation with limited available blocks. On the other hand the blocks that have not been learned are invisible, which helps learners think about the algorithm without stress.

2.2 Learning Support Functions

2.2.1 Overview

The system with the features explained in the previous subsection was developed using the Web2pf framework. The combination of some elements represents the structure of the algorithm. Each process is described with a combination of comment statements and a selection of items.

Fig.1 shows an example screen shot of our algorithm editor for learners. In this system, a user chooses an element for use in the algorithm by double clicking on the editor area. A learner constructs an algorithm with blocks which were chosen. Executable parts are connected to the “start” block (upper left area in Fig.1). The sets of blocks that are not used can also be put in this editor area. They are shown in gray. A learner can watch the change in the variable values that he/she uses in his/her algorithm. Moreover, some output data can also be watched in this editor.

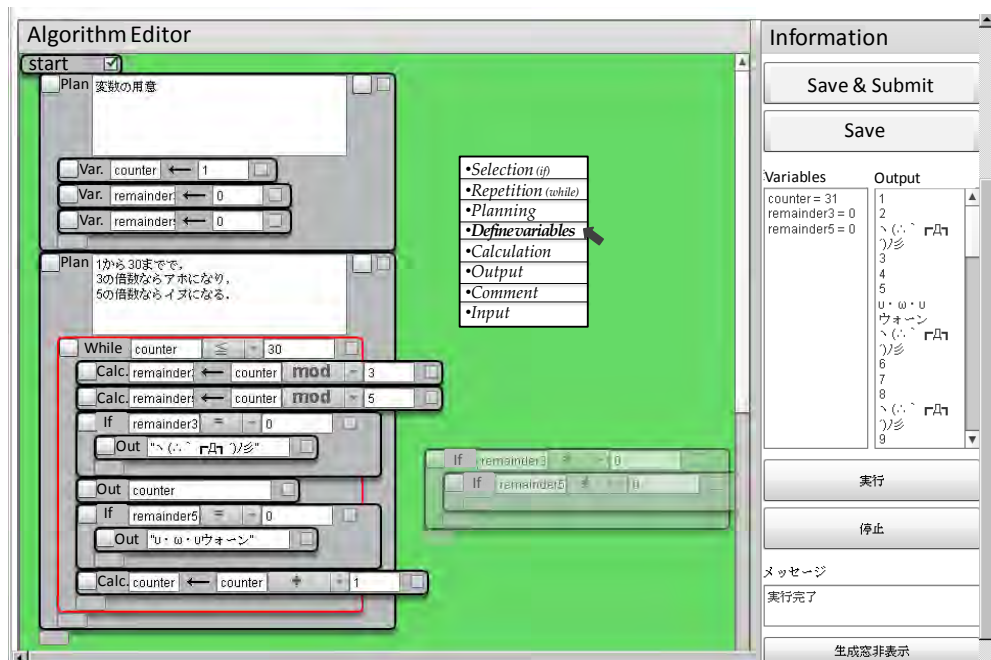

Figure 1. The algorithm editor of our tool.

There are two kinds of blocks, structural blocks and commentary blocks. The structural blocks are calculation, variable declaration, selection, repetition and break. The selection block and repetition block can be nested in other blocks. The commentary blocks are planning and comment. The planning block can be nested in other blocks including structural blocks.

Fig.2 shows the window where rules can be defined for describing the algorithm and the selectable items for the learners. A teacher can define the description rules for each algorithm question. He/she only needs to click the check boxes shown in Fig.2, and then saves this rule with a name. When he/she submits a question, one description rule can be attached.

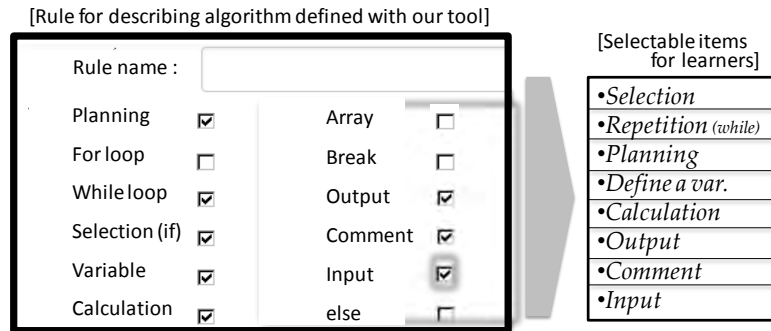

Figure 2. Definition of the rule for describing the algorithm.

The teacher usually plans the learning steps for his students. As an example, suppose that the first step is a calculation by assignment and/or arithmetic operations with abstract numbers and/or variables, the second step is a conditional test with relational operations and the third step is an iteration with termination conditions. Corresponding to these steps, the algorithm description rules can be defined. Fig.3 shows this set of learning steps and the description rules.

2.2.2 Element Usage of Control

Each teacher has his/ her own policy to teach algorithmic thinking. Each policy has to be appreciated because a teacher has a responsibility for his/her course. Therefore, by using our system, teachers can control which elements are visible according to the class rules. Different algorithm building elements are attached to the three steps in Fig.3. The rule set can be independently managed for each step. A teacher can set this rule before his/her lesson. This rule can be changed during the lesson.

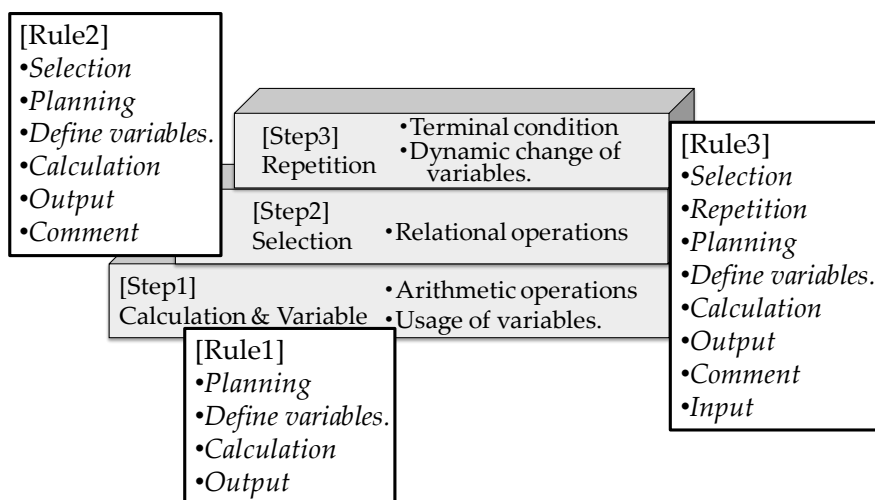

Figure 3. The learning steps and the algorithm description rules.

Moreover, a teacher can define which activities are permitted for constructing algorithms, i.e., permit to submit, save, execute, edit, syntax check, show program code, log operation history or not. In our system, these things are defined as controllable elements. By using this function, the teacher can define an algorithm reading task (not permit learners to edit and run), an algorithm reading and running task (not permit learners to run) and a scaffolding task (give a template algorithm using planning blocks with teacher's comments).

Teachers can also decide whether the trace function is available and its interval. Teachers can make the trace function available to debug the algorithm or to make it unavailable to make learners think about tasks and learning progress. If a teacher gives permission to use this function, learners can trace the execution of the algorithm and specify a variable when tracing. The right area in Fig.1 shows a variable trace area and the result of algorithm tracing (output area).

2.2.3 *Template for each Task*

This allows learners to see a part of the algorithm or the whole algorithm on their monitor. Therefore, combining this function with the learning activity control function, learners use this system to dissect the algorithm, finish incomplete parts of the algorithm, select a suitable algorithm from some choices, and describe the algorithm from scratch.

2.2.4 *Simple Task-Answer Management System*

a) State management of learners' reports

This system helps teachers and learners manage the report status for each learner and each task. For instance, saved but not submitted, submitted, rejected, accepted, unevaluated or evaluated. Students' answers are divided into two columns: unevaluated and evaluated. In the evaluated answers, a grade for each answer is shown.

b) Semi auto test for the submitted answers

If a teacher defines the test rules for a problem, our system tests students' answers automatically. There are three types of test results: 1) normal exit and the algorithm outputs the expected results (OK), 2) normal exit but the algorithm does not output the expected results (NG), 3) grammatical error or abnormal exit or time out (??).

2.2.5 *eAssessment functions based on Student-Problem Score Table Analysis*

The student-problem (SP) score table analysis is an educational analysis method based on students' responses, i.e. test score patterns [Sato 1974, Harnisch 1981]. The SP score table is a two-dimensional table where rows are student numbers and columns are problem (i.e., test question) numbers. In the table, if a particular student answers a particular problem correctly, the cell is filled with a 1. Otherwise, the cell is filled with a 0. This table is sorted by column and by row in decreasing order of occurrence of 1s. The students are sorted by their total score. If some students have the same score, they are ordered based on the sum of the number of correct answers to the problem which they answered correctly.

As a consequence, the upper-left triangular region is filled with nearly all 1s. Ideally, students with higher scores should solve those problems which are answered correctly by most students. Similarly, if a problem is solved by most of the students, a good student is able to solve the problem.

3. eAssessment with Our Tool

3.1 S Line and P Line

In an SP score table, there are two types of lines named the S line and the P line.

The S line is defined based on the scores of all students. Starting from the top student of the table, for each student, a short vertical line is drawn on the right of the score for the problem column which is the same as the student's score. The S line shows the frequency distribution of the students' scores. Ideally, there should only be 1s on the left side on this line and 0s on the right side. Teachers can capture the status of the achievement of each student.

The P line is defined based on the score of all problems. From the highest score problem, for each problem, a horizontal line is drawn below the score for the student row which is the same as the number of correct answers for the problem. This line shows the frequency distribution of the problems' score. Ideally, only 1s should be above this line and 0s below it. Teachers can capture the suitability of each problem or the effect of his/her instruction.

These two lines are ideally located close together in the table. The difference between the S line and the P line shows some pedagogical agenda to be solved.

1. The suitability of problems for this learner group.
2. The effectiveness of the teacher's instruction for this learner group.
3. The achievement level of each student.
4. The variation in learning abilities of the learners.

3.2 Caution Indices

This method includes two index types: a caution index for students (C_s) and a caution index for problems (C_p).

3.2.1 Caution Index for Student

By using the C_s index, we can easily detect the students who need attention. Theoretically, the threshold value is 0.5. If there are students whose values are under 0.5, they show abnormal response patterns for the problems, i.e., careless mistakes by high achieving learners and lucky guesses by low achieving learners. Moreover, teachers can diagnose students who cannot use the learning environment, especially the description method.

The combination of the C_s index and the percentage of questions answered correctly expresses the achievement level of students. We call this graph the Student Score Graph. Fig.4(a) shows our interpretation of the Student Score Graph. The vertical axis is the number of problems answered correctly (Num. for short) and the horizontal axis is the C_s index. This graph is separated into 4 sections by the vertical axis (Num.) threshold value of 50% of total problems and the horizontal axis (C_s) threshold value of 0.5. The left part of this graph is when the C_s index is less than 0.5. The students in this area seem to have normal reactions to the problems. If a student is in the upper left section (Num. \geq 50%), he/she is a “good” student. The lower left section (Num. $<$ 50%) is a “developing” student who needs more practice.

The right part is when the C_s index is more than 0.5. The students in this area seem to have abnormal reactions to the problems. Students in the upper right section, where Num. is high, tend to make careless mistakes for fundamental problems or to not fully acquire the related knowledge. When Num. is low and the C_s index is high, the comprehension of the students is quite uncertain. Students in the lower right section tend to have unstable answers. Therefore, they require special attention from the teacher. In our research, the C_s index has been used to identify students who need attention in each lesson.

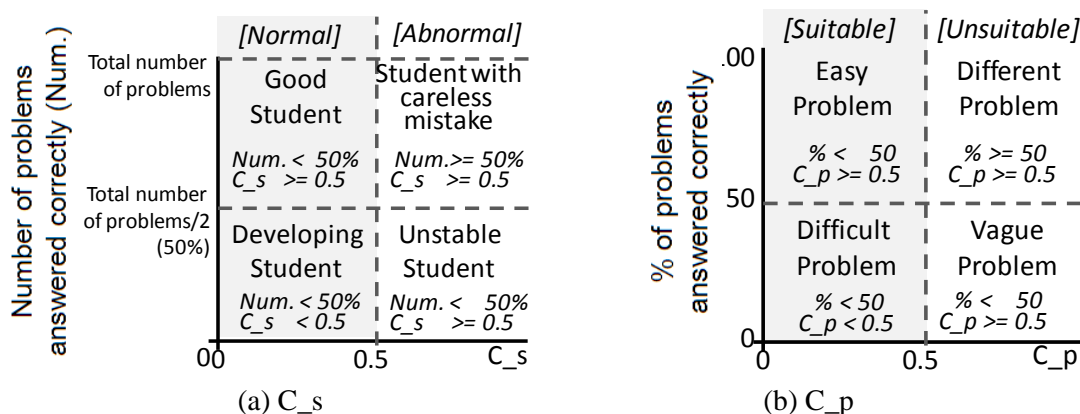

Figure 4. The relation of the Caution Indices and the number/percentage of the problems answered correctly

The right graph in Fig.5 is an example of the Student Score Graph. The radius of each circle represents the number of students located at that position. The center position of each circle shows the score combination. The five students mentioned above are located in the lower right section. The teacher may give these students particular attention.

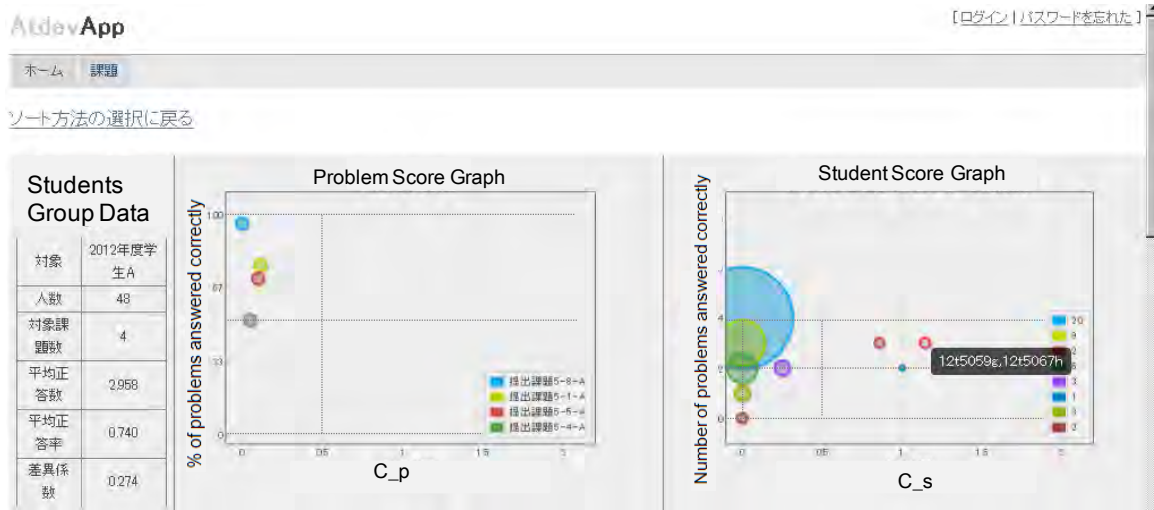

Figure 5. Problem score graph and Student score graph generated by proposed our tool.

3.2.2 Caution Index for problem

By using the C_p index, teachers can analyze the quality of a problem. We can detect inadequate questions which may include vague instructions or ill-structured tasks. Theoretically, the threshold value is 0.5. If $C_p < 0.5$, teachers can modify or delete defective problems, and fit good ones into an item bank for future use. In Fig.5, there are no problems that need to be improved because their C_p indices are all under 0.5.

The combination of the C_p index and the percentage of problems answered correctly expresses the appropriateness of the problem to evaluate the students' abilities. We call this graph the Problem Score Graph. Fig.4(b) shows our interpretation of the problem score graph. The vertical axis is the percentage of problems answered correctly (% in short) and the horizontal axis is the C_p index. This graph is separated into 4 sections by a % threshold value of 50% and a C_p threshold value of 0.5.

The left part of this graph is when the C_p index is less than 0.5. This means the problems in this area are "suitable" to evaluate students' abilities. If a problem is in the upper left section ($\% \geq 50$), it is an "easy" problem. A problem in the lower left section ($\% < 50$) is a "difficult" problem which good students tend to answer incorrectly. The right part is when the C_p index is more than 0.5. This means the problems in this area are "unsuitable" problems to evaluate students' abilities. If a problem is in the upper right section, however, the % is high, so this problem includes some "different" factor to evaluate target abilities. A problem in the lower right section is a "vague" problem. The % is low and the C_p index is high. This means the problem includes ambiguity factors in its description. For example, the problem statement is difficult to read, or the way of answering the problem is not suitable for the learning environment. The C_p index has been used for evaluating the quality of each problem for each school year. The left graph in Fig.5 is a Problem Score Graph..

3.3 Practical Usage

We have been using this method to assess the problems in our course [Kayama 2014b]. In 2011, we made six groups of problems.

(A) Algorithm creation with guidance. A learner is given some variables with their initial values which can be used to create the algorithm, and guidance for creating the algorithm. He has to add appropriate blocks based on the given guidance.

(B) Algorithm creation from scratch. A learner has to add appropriate blocks without guidance. He is only given some variables with their initial values. If he does not want to use the given variables, he can define other variables.

(C) Algorithm creation by filling in blanks and adding explanations. A learner is given an incomplete algorithm with some blanks. He has to try to read the intention of the algorithm with the given blocks. After that, he adds some appropriate blocks to create the complete algorithm (C1). Then he is asked to explain the procedure by adding blocks (C2).

(D) Addition of the explanation for the procedures in the algorithm. A learner is given a complete algorithm with some "Plan" blocks. He is asked to explain each procedure in the blocks.

(E) Addition of the explanation for whole algorithm and the block sets in the algorithm. A learner is given a complete algorithm with some "Plan" blocks as in (D). He is asked to explain the whole algorithm (E1) and each procedure in the blocks (E2).

(F) Addition of the estimated value for the output and explanations of the block sets in the algorithm. A learner is given a complete algorithm with some “Plan” blocks as in (D) and (E). He is asked to explain the estimated value for the output (F1), and each procedure in the blocks (F2).

(A) and (B) are algorithm creation problems. On the other hand, (D), (E) and (F) are algorithm reading problems. Only (C) is categorized as both.

In each problem group, there is one calculation problem, two selection problems, two repetition problems and one combination problem, for a total of six problem types.

Therefore, we prepared 36 problems to analyze the appropriateness of the problems to evaluate the learners' abilities in algorithm creation and reading.

The subjects were 96 freshmen, who had finished our “algorithmic thinking” course. These students were divided into 6 groups. Each group was assigned six problems, one from each problem group and problem type. They had to answer all the problems in 90 minutes.

Table 1 shows the analysis result using our tool. In this table, each cell is marked in one of three categories: blank, difficult and different. Blank indicates that the problem is in the “Easy Problem” area in Fig.5(b). Difficult indicates that the problem is in the “Difficult Problem” area. Different indicates that the problem is in the “Different Problem” area. There are no “Vague Problems” in this test.

As for the algorithm reading problems, the “Different Problems” tend to be “explain the procedure” group problems (especially D, E2 and F2). As for the algorithm creation problems, (C1) asks students to fill in blanks in a given algorithm. This problem is the most difficult of the 6 problem groups. The percentage of students who answered this problem correctly shows a statistically significant difference between (B), which asks students to create an algorithm from scratch and (F), which asks students to estimate the output value from a given algorithm.

Table 1: The problem assessment with the SP score table analysis in 2011.

		Calculation	Selection1	Selection2	Repetition1	Repetition2	Combination
Algorithm Creation Problems	(A) Creation with guidance				Different		
	(B) Creation from scratch		Difficult				
	(C1) Creation by filling in blanks		Difficult		Difficult		Difficult
Algorithm Reading Problems	(C2) Addition of the explanations					Difficult	Difficult
	(D) Explaining the procedure in blocks			Different			
	(E1) Explaining the whole algorithm						
	(E2) Explaining the procedure in blocks	Different			Different		
	(F1) Explaining the estimated value for the output				Different		Difficult
	(F2) Explaining the procedure in blocks		Different			Difficult	Difficult

Based on these facts, we chose two groups of questions: (B), which is algorithm creation from scratch, and (F1), which is the estimated value of the output, to evaluate the students' abilities.

About the problem types, this table shows that the Selection1 problem type is more difficult than the Repetition1 type. Moreover, we found that students who can solve Selection1 can get a higher score in the repetition problems. Repetition1 has “Different” marked in 3 problem groups. This result shows that Repetition1 in this test is not a suitable problem type to evaluate students' abilities.

In 2012, we introduced two of the groups of problems mentioned above. For each problem group, we prepared eight types of problems. The subjects were 95 freshmen who had finished our “algorithmic thinking” course. These students were divided into two groups. Each group was assigned eight problems (four algorithm reading problems, and four algorithm creation problems), one from each problem type. They had to answer all problems in 90 minutes.

The relationship between the C_p index and the percentage of problems answered correctly is shown in Fig.6(a) (algorithm creation problems) and Fig.6(b) (algorithm reading problems). The suitability of the problems was confirmed for all problems. They are located in the “Suitable” area. Though some problems are “Difficult Problems” for this group, overall these problems are suitable to evaluate our students' abilities.

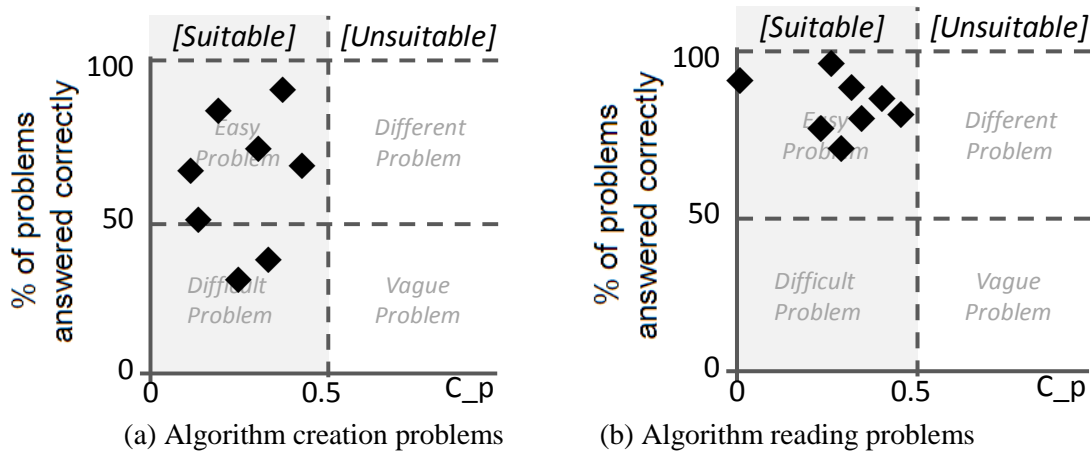

Figure 6. The relation of the C_p index and the percentage of problems answered correctly for 2012 problems.

4. Conclusion

In this paper, we described the pedagogical features and main functions of a learning support system for algorithmic thinking education. We have used this system since 2008 in our computer science course. The ability to control the usage of algorithmic elements such as input, output, selection or repetition is a unique function that no other system has had before. Teachers can define the element usage rule depending on the learning progress of their learners and their educational philosophy.

Moreover we show our eAssessment function based on the SP score table analysis. By using this function, we have reviewed the problems used in our course. As a result, the pedagogical quality of the problems has improved. In the future, we will pedagogically analyze and design learning scenarios with this supporting system.

Acknowledgements

This work is supported by MEXT/JSPS Grant-in-Aid for Scientific Research (KAKENHI) : 22300286.

References

- Bruner, J. : The Process of Education, Harvard University Press, MA, 1960.
- Cook, M.E. : Guided Discovery Tutoring: A Framework for Icai Research, Van Nostrand Reinhold, NY, 1991.
- Fuwa, Y., Kunimune, H., Kayama, M., Niimura, M., & Miyao, H.,: Implementation and Evaluation of Education for Developing Algorithmic Thinking for Students in Computer Science, The Institute of Electronics, Information and Communication Engineers, Technical Report of ET, 109(268), 51-56, 2009.
- Futschek, G. & Moschitz, J.: Learning Algorithmic Thinking with Tangible Objects Eases Transition to Computer Programming, Proc. of 5th International Conference on Informatics in Secondary Schools, 155-163, 2011.

- Harnisch, D.L. & Linn, R.L.: Identification of Aberrant Response Patterns: Final Report, Education Commission of the States, 1981.
- Hubalovsky, S., Milkova, E., Prazak, P., Hubálovský, Š., Milková, E. & Pražák, P.: Modeling of a real situation as a method of the algorithmic thinking development and recursively given sequences, WSEAS Transactions on Information Science and Applications , 7(8), 1090-1100, 2010.
- Knuth, D.E.: Algorithms in modern mathematics and computer science, Stanford Department of Computer Science Report No. STAN-CS-80-786, 1980.
- Kayama, M., Satoh, M., Kobayashi, K., Kunimune, H., Hashimoto, M., & Otani M.: Algorithmic Thinking Learning Support System based on Student-Problem Score Table Analysis, International Journal of Computer and Communication Engineering, 3(2), 134-140, 2014.
- Kayama, M., Satoh, M., Hashimoto, K., Otani, M., Kunimune, H., & Niimura, M., : Algorithmic Thinking Learning Support System with eAssesment Function, Proc. of the 14th IEEE International Conference on Advanced Learning Technologies, 185, 2014.
- Sarawagi, N.: A general education course – “Introduction to Algorithmic Thinking” - using Visual Logic, J. of Computing in Sciences in Colleges, 25(6), 250-252, 2010.
- Satoh, T.: A classroom information system for teachers, with focus on the instructional data collection and analysis, Proc. of ACM '74 annual conference, 1, 199-206, 1974.
- Stone, H.S.: Introduction to Computer Organization and Data Structures, McGraw-Hill, New York, 1972.

Learning by Posing Problems Using Illustrations Instead of Words

Takanobu UMETSU^{a*}, Hikaru ETO^a, Tsukasa HIRASHIMA^b & Akira TAKEUCHI^a

^a*Computer Science and Systems Engineering, Kyushu Institute of Technology, Japan*

^b*Department of Information Engineering, Hiroshima University, Japan*

*umetsu@ai.kyutech.ac.jp

Abstract: Learning by posing arithmetic word problems is well-recognized as an effective means to mastering the use of solution methods; however, several learners cannot pose problems using words. In problem-solving exercises, if a learner cannot understand what is expressed in a problem statement, an illustration of the scene expressed in the statement can help the learner understand. Therefore, in this paper, we propose learning by posing problems with illustrations instead of words. One of the purposes of learning mathematics is to acquire the ability to derive a numerical relation from a scene and to associate a calculation expression with various scenes. We expect that posing problems via illustration and without words is an effective way for beginners to learn. In the problem-posing exercises, learners construct various types of problems. Teachers have to evaluate each posed problem and advise learners on the basis of the evaluations. This task places a heavy burden on teachers. Therefore, we developed a computer-based environment for posing problems using illustrations. The environment provides a learner with a calculation expression and illustrations. The illustrations can be disassembled into several figures. A learner assembles an illustration that describes a story of arithmetic problem that correspond to the calculation expression by combining the figures. The learner uses no sentences in this problem-posing exercise. The environment diagnoses the illustration problem and produces advice to the learner. We conducted a preliminary evaluation of the environment to confirm that a learner who cannot pose problems via words was able to pose problems using illustrations. Our results were promising, indicating that our environment provides a means for learners who cannot pose problems via words.

Keywords: Problem-posing, interactive learning environment, visualization, arithmetic problem

1. Introduction

In this paper, we describe a computer-based environment for learning by posing problems expressed using illustrations for learners who cannot describe problems using words.

Learning by posing arithmetic word problems is well-recognized as an effective way to master the use of solution methods (Polya, G., 1945) (Ellerton, N. F., 1986) (Yu, F., Liu, Y. H., and Chan, T. W., 2003); however, it can be difficult to provide problem-posing exercises wherein learners construct various types of word problems. Because it is difficult to prepare adequate feedback for every problem that learners construct, teachers are required to evaluate each posed problem and advise learners on the basis of the evaluations, which places a heavy burden on teachers.

Given these circumstances, a computer-based learning environment called MONSAKUN was developed for interactive problem posing using arithmetic word problems (Hirashima, Yokoyama, Okamoto, and Takeuchi, 2007) (Hirashima and Kurayama, 2011). MONSAKUN provides learners with disassembled sentences and calculation expressions. The learner is required to pose a problem that is solvable by the calculation expression by selecting some of the sentences and sorting them into their proper order. MONSAKUN diagnoses the combination of the sentences and presents advice to the learner; however, there are several learners who cannot pose problems from the disassembled sentences in MONSAKUN.

In problem-solving exercises, if a learner cannot understand what is expressed in a problem statement, an illustration of the scene expressed in the statement can help the learner understand.

Therefore, in this paper, we propose learning by posing a problem expressed by illustrations instead of words. First, a calculation expression is presented to a learner. Next, the learner poses a problem by creating an illustration that describes a story of increasing, decreasing, or combining illustrated elements that match the calculation expression. The learner uses no sentences in this problem-posing exercise.

One of the purposes of learning mathematics is to acquire the ability to derive a numerical relation from a scene and to associate a calculation expression with various scenes. We expect that posing problems via illustration and without words is an effective way for beginners to learn.

We developed a computer-based environment for posing such illustration problems. This environment provides learners with components of the illustration and a calculation expression. As noted above, the learner assembles a scene that describes a story of increasing, decreasing, or combining elements that correspond to the calculation expression. The illustration is assembled by combining its components. The environment diagnoses the illustration problem and produces advice to the learner. In this paper, we introduce our learning environment and present results of a preliminary evaluation of the environment.

2. Related Work

Arithmetic textbooks in elementary school are replete with illustrations to help learners understand. The visualization approach has generated new enthusiasm for mathematics and has improved problem-solving performance (Moses, 1982). Learning by posing problems using illustrations is based on this viewpoint. We expect posing illustration problem as being a more effective means for learners who cannot describe problems by words.

Joya's "fraction block" (Joya, Maeda, and Hirashima, 2013) is similar to our research wherein a learner creates an illustration that describes a numerical relationship. The fraction block reifies characteristics of "ratio fraction" as a pair of numerator and denominator blocks. The block length can be varied by maintaining the same ratio of numerator blocks to denominator blocks. Joya developed a learning environment wherein learners can directly operate these fraction blocks to derive one quantity from another.

Although both Joya's and our environment use illustrations, there is a difference in purpose. The fraction block is a kind of graph. Hanagata (1990) stated that graphs and diagrams help learners understand quantitative relations and solution methods for a variety of problems; however, Hanagata also noted that graphs and diagrams rarely help to understand what is expressed in problem statements in the early stages of mathematical development. A beginner cannot associate abstract figures on the basis of the solution method such as the fraction block with a problem sentence if the beginner is unaccustomed to the abstract figures.

Hanagata suggested that an illustration of the scene expressed in the statement helps learners understand what is expressed more than graphs and diagrams in the early stages of learning, because the learners can directly associate the illustration with a scene in their life. The purpose of our research is to support learners who cannot pose problems in the form of sentences, therefore we do not use graphs and diagrams, but rather than illustrations of the given scenes.

3. Learning by Posing Illustration Problems

In this section, we describe learning by posing problems using illustrations instead of words. First, we describe a structure of problems in our learning environment. Next, we describe how to pose a problem using illustrations in our system.

3.1 Structure of Problem

Our research focuses on problems that are solved by either one addition or subtraction operation. Addition and subtraction operations can be classified into increase-change, decrease-change, combine, and compare (Riley, Greeno, and Heller, 1983). Our learning environment can diagnose increase-change, decrease-change, and combine operations. Increase-change and combine problems are solved via addition formula $A + B = C$. Decrease-change problems are solved via subtraction formula $A - B = C$.

The structure of problems in our learning environment is based on MONSAKUN, which is a learning environment for problem posing by words. Yamamoto, Kanabe, Yoshida, Maeda, and Hirashima (2012) explained the structure of problems in MONSAKUN. In MONSAKUN, a problem comprises three sentences. Two of the three sentences are “existence sentences,” which express a number of objects. The third sentence is a “relation sentence,” which expresses a numerical relation between the objects in the two existence sentences. For example, the following sentence is an increase-change problem: “Tom has three pencils. Tom buys two pencils. Then, Tom has five pencils.” The first and third sentences are existence sentences, whereas the second sentence is a relation sentence. The numerical relation in the problem is $3 + 2 = 5$.

Much like MONSAKUN, a problem in our system comprises three illustrations. Two of the three illustrations express a number of objects, and the third expresses a numerical relation between the objects.

Our learning environment provides three kinds of objects for existence illustrations, namely: food, money, and people. A person can have food and money. The environment also provides several places wherein people exist. For example, a learner can assemble existence illustrations corresponding to the following sentences: “Taro has three apples”; “Taro has five dollars”; and “Three people are in the sandbox.” Figure 1 shows an example of an existence illustration.



Figure 1. Example of an existence illustration

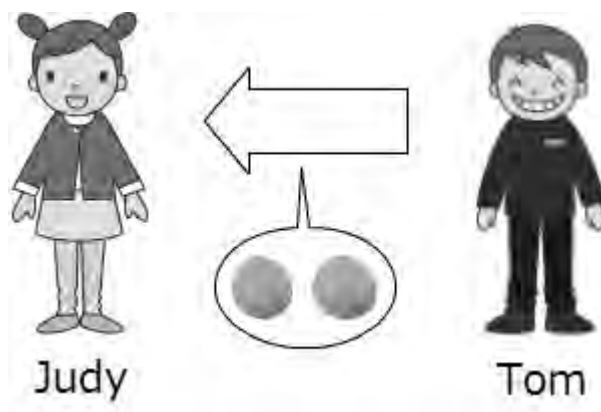

Figure 2. Example of a relation illustration

In our environment, a learner can express “give/get,” “buy/sell,” “move” and “combine” via relation illustrations. The actions “give,” “get,” “buy,” “sell,” and “move” are illustrated using an

arrow, as shown in Figure 2. “Give” and “get” are expressed by the same figure, depending only on the different subjects at each arrow endpoint, as are “buy” and “sell.” More specifically, “give/get” is a movement of food and is illustrated by an arrow annotated with food between two people. “Buy/sell” is illustrated by an arrow with money and food between a person and a store. “Move” is a movement of people and is illustrated by an arrow with people between places. We do not provide an illustration for “combine”; however, a learner can assemble a “combine” illustration by combining two existence illustrations. Figure 2 shows an example of a relation illustration in which Tom gives Judy two oranges.

If a problem includes a relation of “give/get,” “buy/sell,” or “move”, there is a temporal ordering between the three illustrations. One illustration is anterior to the increase or decrease. The other is posterior to the increase or decrease. In the case of word problems, existence sentences are arranged in a temporal order. For example, in the following word problem, Taro had three pencils before buying and therefore has five pencils after the buying: “Taro has three pencils. Taro buys two pencils. Taro has five pencils.”

In posing illustrations, we provide morning, noon, and evening illustrations to express temporal order. If a learner wants to pose an increase/decrease problem, the problem is composed of an existence illustration in the morning, a relation illustration at noon, and an existence illustration in the evening.

3.2 Interface for Posing Illustration Problems

In this subsection, we describe how to pose a problem using illustrations in our system. Figure 3 shows an interface of our learning environment. First, the environment provides a learner with a calculation expression (upper left portion of Figure 3) and illustrations (right portion of Figure 3). The illustrations can be disassembled into several figures. A learner assembles an illustration problem that corresponds to the calculation expression by combining the figures. The lower left portion of Figure 3 shows the illustration problem in the process of assembly.

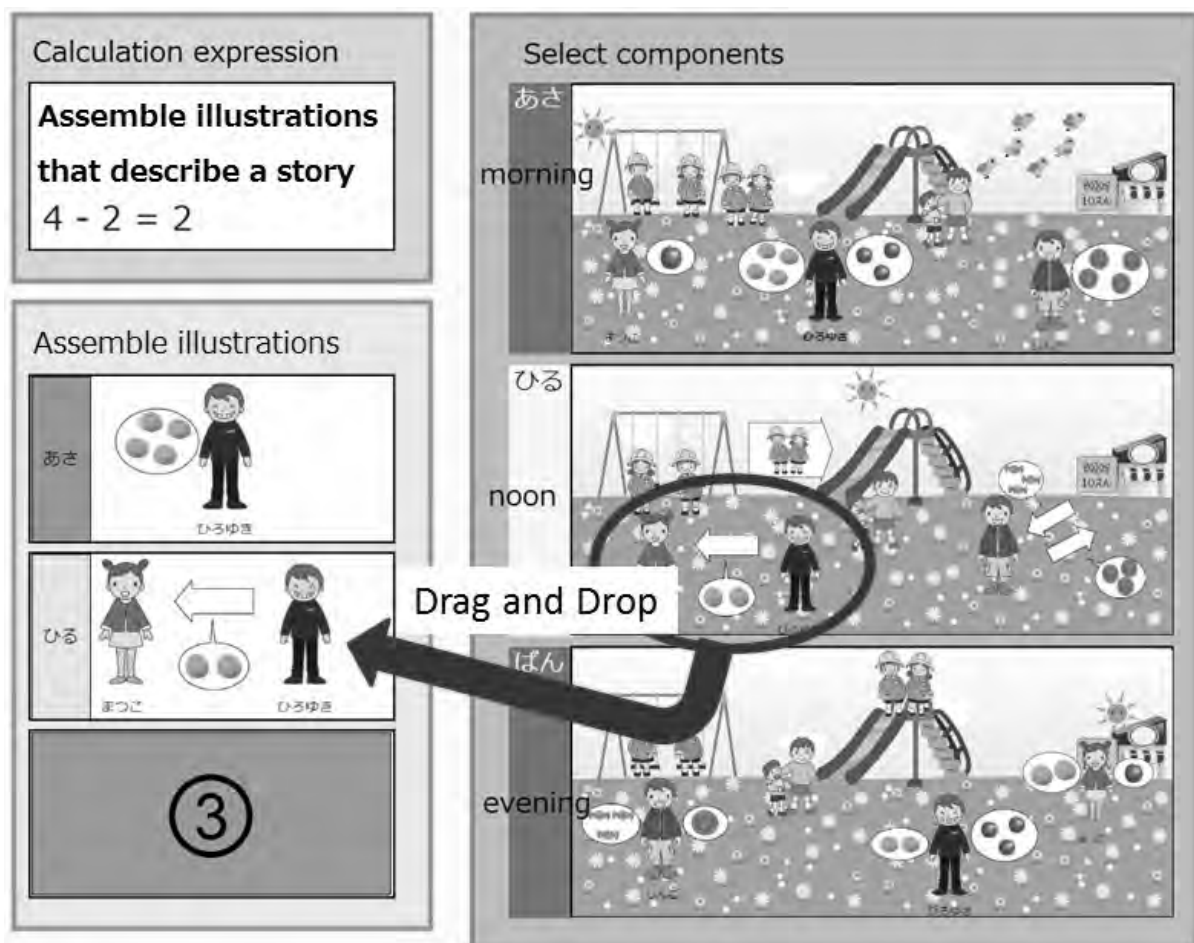

Figure 3. Interface for posing illustration problems

The illustrations provided comprise all types of illustration problems: “give/get,” “buy/sell,” “move,” and various combine problems. A learner selects one illustration problem that corresponds to the calculation expression from the provided illustrations. The system provides the illustrations by combining various existence illustrations and “give/get,” “buy/sell,” and “move” relation illustrations so as not to logically contradict. If a problem includes an increase or decrease relation, there is a temporal order as noted above. Therefore, the provided illustrations are composed of morning, noon, and evening illustrations. The system combines various existence and relation illustration based on the temporal order.

In the illustrations provided in the right portion of Figure 3, there are 20 illustration problems: three increase-change problems, three decrease-change problems, 14 combine problems. Two of the 20 illustration problems corresponds to “ $4 - 2$.” The illustration in the morning in the upper portion of Figure 3 comprises six existence illustrations: “Four people are by the swing”; “Two people are by the slide”; “Matsuko has an apple”; “Hiroyuki has four oranges”; “Hiroyuki has three apples”; and “Shingo has 40 yen.” The illustration at noon in the middle portion of Figure 3 comprises four relation illustrations: “Two people move from the swing to the slider”; “Matsuko gets two oranges from Hiroyuki (Hiroyuki gives two oranges to Matsuko)”; “Shingo buys three candies from the shop (The shop sells three candies to Shingo)”; and “Shingo buys the candies for 30 yen from the shop (The shop sells the candies for 30 yen to Shingo).” The illustration in the evening in the lower portion of Figure 3 comprises eight existence illustrations: “Two people are by the swing”; “Four people are by the slider”; “Shingo has three candies”; “Shingo has 10 yen”; “Hiroyuki has two oranges”; “Hiroyuki has three apples”; “Matsuko has two oranges”; and “Matsuko has an apple.” As noted above, there is no “combine” relation illustration in Figure 3, because a learner can assemble a “combine” illustration by combining two existence illustrations.

Each existence and relation illustration can be moved by drag-and-drop freely in the interface. A learner selects two existence illustrations and one relation illustration and then moves them into the blanks in the lower left portion of the interface (see Figure 3) to pose a problem. Time information is also moved into the blanks using the drag-and-drop. Note that there are three blanks because a problem comprises two existence illustrations and one relation illustration. If a learner wants to express a combine relation, the learner moves two existence illustrations into the same blank, means calculating a total number of objects in the two existence illustrations.

Next, our environment diagnoses the illustration problem and outputs whether it is correct. If incorrect, the reason or reasons why is displayed. The problem sentence represented by the illustration problem is also displayed. This problem sentence helps a learner understand the meaning of the assembled illustrations and see how to describe a problem.

If an illustration problem includes a figure consisting of an arrow with food, the system outputs two problem sentences. Because the arrow with food is translated into “give” and “get,” the system describes the problem in two ways (i.e., the “give” relation and the “get” relation). Similarly when a figure consists of an arrow with money and food, the system outputs both “buy” and “sell” sentences. In short, the illustration problem can be transformed into two problem sentences, and the two problem sentences correspond to the same calculation expression.

4. Implementation

In this section, we describe how our system diagnoses an illustration problem. First, we describe information comprising illustrations for the diagnosis. Next, we describe how to diagnose a problem with the information in our system.

4.1 Illustration Information

An existence illustration contains the following information: the type of illustration, the corresponding verb, the object name, the number of objects, the owner or place, and the temporal order. The type of illustration is used to distinguish between existence and relation. The verb is used to translate the illustration into a problem sentence. Figure 4 shows an example of this set of information.

Type of illustration: existence
Verb: has
Object name: apple
Number of objects: 2
Owner: Tom
Temporal order: morning

Figure 4. The Example of information comprising an existence illustration

An increase/decrease relation illustration contains the following information: the type of illustration, the corresponding verb, the increased/decreased object name, the increase/decrease number, the owner whose objects are increased, the owner whose objects are decreased, and the temporal order. Figure 5 shows an example of this set of information. There is no information for the combine relation, because we do not provide illustrations for combining.

Type of illustration: relation
Verb: give/get
Increased/decreased object: apple
Increase/decrease number: 2
Owner whose objects are increased: Taro
Owner whose objects are decreased: Judy
Temporal order: noon

Figure 5. The Example of information comprising a relation illustration

4.2 *Diagnosis of a Posed Illustration*

Our environment first checks whether the illustration problem is composed of two existence illustrations and one relation illustration. Otherwise, the system displays “It is not an arithmetic problem. A calculation expression is not formed. The first (or second/third) illustration is incorrect.”

If the relation illustration is an increase/decrease relation, the environment checks that the object names in the three illustrations are the same. Otherwise, the system displays “There is no relation between <object name A> and <object name B>.” Furthermore, the environment checks that the temporal order in one existence illustration is morning, the other existence illustration has a temporal order of evening, and the temporal order in the relation illustration is noon. Otherwise, the system displays “An illustration before (or after) the giving (or buying/moving) is required. Select an illustration in the morning (or evening).” Next, the environment checks that the owner of objects in one existence illustration is the same as the owner whose objects are increased, and the owner of objects in the other existence illustration is the same as the owner whose objects are decreased. Otherwise, the system displays “There is no relation between <owner A> and <owner B>.”

Finally, the environment derives a calculation expression from the illustrations and ensures the derived calculation expression matches the provided calculation expression. If the owner of objects in the morning illustration is the same as the owner whose objects are increased, the calculation expression is “number of objects in the morning illustration” + “increase number in the relation illustration” = “number of objects in the evening illustration.” Conversely, if the owner of objects in the morning illustration is the same as the owner whose objects are decreased, the calculation expression is “number of objects in the morning illustration” – “increase number in the relation illustration” = “number of objects in the evening illustration.” If the derived calculation expression is different from the provided calculation expression, the system displays “These illustrations do not correspond to the calculation expression. The calculation expression of these illustrations is <derived calculation expression>”

If the relation illustration is a combine relation, the environment checks that the temporal order of all illustrations is the same. Otherwise, the system displays “There is no relation between a number of

<object name> in the <temporal order A> and a number of <object name> in the <temporal order B>.” Next, the environment checks that the relation illustration comprises the other illustrations. Otherwise, the system displays “There is no relation between first (or third) illustration and second illustration.” Furthermore, the environment checks that the object types in the three illustrations are the same. For example, it is meaningless operation that a number of food plus an amount of money. If one illustration includes food, the others must include food. If the object types are different, the system displays “It is meaningless operation that a number of <object name A> plus a number of <object name B>.”

Finally, the environment derives a calculation expression from the illustrations and ensures the derived calculation expression matches the provided calculation expression. The calculation expression is “number of objects in one existing illustration” + “number of objects in the other existing illustration” = “total number of objects in the two existence illustrations.” If the derived calculation expression is different from the provided calculation expression, the system displays “These illustrations do not correspond to the calculation expression. The calculation expression of these illustrations is <derived calculation expression>”

5. Evaluation

We conducted a preliminary evaluation of our environment to confirm that a learner who cannot pose problems via words was able to pose problems using illustrations. The participants of our study were four seven-year-old children. They were divided into two groups. Two of the four participants were first posed problems using words via MONSAKUN and then posed problems using illustrations via our environment. The other two participants first used our environment and then used MONSAKUN.

We started by first explaining problem posing to all four participants. Next, we explained how to use MONSAKUN to the two participants. These two participants used MONSAKUN for 15 minutes. After using MONSAKUN, we explained how to use our environment. These two participants then used our environment for 15 minutes. For the other two, we first explained how to use our environment, and they used our environment for 15 minutes. After using our environment, we explained how to use MONSAKUN, and they used MONSAKUN for 15 minutes.

MONSAKUN can provide various types of problem-posing exercises. In this evaluation, the participants posed the easiest type. MONSAKUN provided the participants with a calculation expression without the result of the calculation. The participants were required to pose a word problem that is solvable by the calculation expression by selecting two positive sentences and one interrogative sentence and sorting them into their proper order. For example, MONSAKUN provided the participants with “ $3 + 2$ ” and the participants posed the following word problem: “Tom has three pencils. Tom buys two pencils. Then, how many pencils does Tom have?” Conversely, our environment provided a calculation expression with the result of the calculation as noted above. One existence illustration expressed the result of the calculation, instead of the interrogative sentence.

Table 1: Results of experimental use.

	Participant	MONSAKUN		Our environment	
		Correct problems	Incorrect problems	Correct problems	Incorrect problems
MONSAKUN → our environment	A	2	9	5	1
	B	6	1	6	0
Our environment → MONSAKUN	C	0	2	1	3
	D	2	2	4	1

Table 1 shows the results of our study. The four participants are indicated by letters A B, C, and D. Participants A and B posed problems via words before posing problems via illustrations; conversely, participants C and D posed problems via illustrations before words. In the table, the number of correct problems is the number of problems correctly posed by the participant. The number of incorrect problems is the number of problems incorrectly posed by the participant.

Participants A, C, and D were not good at posing problems via words. Although participant C was also not good at posing problems via illustrations, participants A and D could pose problems via

illustrations more effectively than via words. Our initial results here suggest that learners who cannot pose problems by words can pose problems by illustrations. Participant B could pose problems by both words and by illustrations. We expect that a learner who understands problem-posing via words can also pose problems via illustrations in the same way.

6. Conclusion

Learning by posing arithmetic word problems is well-recognized as an effective way to master the use of solution methods; however, there are several learners who cannot pose problems via words. Therefore, in this paper, we proposed learning by posing problems using illustrations instead of words and developed a computer-based learning environment for such a task. The environment provides a learner with a calculation expression and illustrations. The illustrations can be disassembled into several figures. A learner assembles an illustration that describes a story of arithmetic problem that correspond to the calculation expression by combining the figures. The learner uses no sentences in this problem-posing exercise. The environment diagnoses the illustration problem and produces advice to the learner. One of the purposes of learning mathematics is to acquire the ability to derive a numerical relation from a scene and to associate a calculation expression with various scenes. We expect that posing problems via illustration and without words is an effective way for beginners to learn.

We also presented results of our preliminary evaluation using four seven-year-old participants. Our results were promising, indicating that our environment provides a means for learners who cannot pose problems via words. In future work, we hope to conduct more evaluations; we require more participants to confirm the effectiveness of our environment. Furthermore, we also plan to implement the “compare” relation, as well as multiplication and division.

References

- Ellerton, N. F. (1986). Children’s Made Up Mathematics Problems: A New Perspective on Talented Mathematicians, *Educational Studies in Mathematics*, Vol.17, pp. 261-271.
- Hangata, E. (1990). Summarizing Fractions by Children, Practical Studies on Elementary School Mathematics in 1990s. *Journal of Japan Society of Mathematical Education*, Vol. 82, No. 10, pp. 102-105 (in Japanese).
- Hirashima, T. and Kurayama, M. (2011). Learning by Problem-Posing for Reverse-Thinking Problems, *AIED2011*, pp. 123-130.
- Hirashima, T., Yokoyama, T., Okamoto, M., and Takeuchi, A. (2007). Learning by Problem-Posing as Sentence-Integration and Experimental Use, *AIED2007*, pp. 254-261.
- Joya, A., Maeda, K., Hirashima, T. (2013). Fraction Block as a Tool for Learning & Teaching Fraction and Its Experimental Use in an Elementary School. *Proc of ICCE2013*, pp. 103-109.
- Moses, B. (1982). Visualization: A different approach to problem solving. *School Science and Mathematics*, 82, pp. 141-147.
- Polya, G. (1945). How to Solve It, Princeton University Press.
- Rliey, M.S., Greeno, J.G, Heller, J.I. (1983). Development of Children’s Problem-Solving Ability in Arithmetic. The Development of Mathematical Thinking, Ginsburg H. (ed.), Academic Press, pp. 153-196.
- Yamamoto, S., Kanabe, T., Yoshida, Y., Maeda, K., Hirashima, T. (2012). A Case Study of Learning by Problem-Posing in Introductory Phase of Arithmetic Word Problems, *Proc. of ICCE2012, Main Conference E-Book*, pp. 25-32.
- Yu, F., Liu, Y. H., Chan, T. W. (2003). A Networked Question-Posing and Peer Assessment Learning System: a Cognitive Enhancing Tool, *Journal of Educational Technology Systems*, Vol.32, No.2, pp. 211 -226.

Structural and trend analysis of tagging as a mechanism for organizing learning resources

Ji-Lung HSIEH*, Li-Chiao CHIU

Graduate Institute of Library and Information Studies, National Taiwan Normal University, Taiwan

*jirlong@ntnu.edu.tw

Abstract: The tagging mechanism has enabled students to organize plenty of online posts, pictures, and academic articles. Previous research has reported that the design of user interfaces for information organization may affect the way of future problem-solving and recall. Over the years, there have been considerable studies on the design of user interfaces for tagging. However, these studies put more emphasis on efficiency of tagging and future recall, but seldom on the structure of tagging outcomes and the tagging process. Therefore, the study designed and compared three types of user interfaces, that is, tag list, tag cloud, and tag network, and then employed network analysis and trend analysis to discover the structural and temporal patterns of tagging. Results of the study showed that, based on the proposed structural indicators and the trend analysis method, the three user interfaces designed for tagging have different degree of effects on tag reusing behaviors. Compared with tag list and tag network, tag cloud can lead more participants to make use of pre-used tags. By visualizing the tagging results as networks for representing the structure of information organization, we further categorized the tagging results into centralized, clustered and separated networks, which can be predicted by the weighted reused times of tags proposed in the study. Besides, participants using tag cloud interface created more clustered networks than those using the other two interfaces. The clustered network structure is corresponding to the selection strategy of the learning resources in the study.

Keywords: Tag, information organization, user interface design, memory, network analysis

1. Introduction

In the current learning environment, information technologies have been widely applied in the information problem solving process, including searching, navigating, reading, retrieving, understanding and organizing steps (Walraven, Brand-Gruwel, & Boshuizen, 2008). These information technologies, such as search engines, annotation software, bookmarks of browsers or social bookmarking services like *Diigo*, may not only alter students' habit of searching information and constructing knowledge (Brand-Gruwel, Wopereis, & Vermetten, 2005), but also affect their metacognitive learning strategies (Brown, 1987).

Before the network became popular, Wyman and Randel (1998) had indicated that information organization may affect the problem solving and recall efficiency. In the current learning environment, many information organization tools have been used in classrooms and students' daily life. For instance, Liu and Chang (2008) applied bookmarking as students' learning portfolio, described how their participants collected, shared and formed discussion groups with tagging mechanism. Maggio et al. (2009) made use of tags to assist the patrons to learn the complicated concept of medical controlled vocabulary. *Diigo*, a popular social bookmarking service on the Internet, promoted a "*Diigo in Education*" service for K12 educators, which allows teachers to collect essential and extended readings for their students. Moreover, Estellés, González, and del Moral (2010) introduced how to integrate *Diigo* into online courses, and provided several successful cases of academic situations such as sharing and keeping track of teaching resources. Im and Dennen (2013) shared their experiences of how their students contributed links and commented on others' collections via *Diigo*.

While tagging mechanism has been widely applied in current Web 2.0 services, most of the above studies put their focus on the social function of tagging such as sharing or collaborative filter.

However, this study, similar to several research (Civan, Jones, Klasnja, & Bruce, 2008; Bergman, Gradovitch, Bar-Ilan, & Beyth-Marom, 2013a, 2013b; Hsieh, Chen, Lin, & Sun, 2008; and Hsieh & Chiu, 2011), centered on the personal information organization function of tagging. The information organization refers to the process that users utilize tools to categorize or label their received information in an ordered way to enhance the efficiency of future problem solving and memory retrieving (Bergman, Beyth-Marom, & Nachmias, 2008; Wyman & Randel, 1998).

However, Wyman and Randel (1998) pointed out that different ways of information presentation may affect the structure, organization, and representation of human physical memory. For example, Marshall (1990) has found that node count and degree of connectivity, two network-based structural indexes, can predict the knowledge of learners. Gitomer (as cited in Wyman and Randel, 1998) compared two groups of repairmen with equal electronics knowledge, and found that the high skilled group can describe components of electronic circuits at a high abstract level. Regarding the user interface for tagging, Gao (2011) and Sen et al. (2006) have shown that the ways of visualizing tags, such as tag list or tag cloud, will affect the future tag selection and application.

Similar to Civan et al. (2008) and Bergman et al. (2013a, 2013b), the author has published a paper (Hsieh et al., 2008) to compare the information organization efficiency between archiving by folder and labeling by tagging. The current study put the focus on the comparison among three user interfaces for tagging, that is, tag list, tag cloud, and tag network. Furthermore, based on the relation between information organization and personal knowledge structure (Wyman & Randel, 1998; Marshall, 1990), the study applied network visualization to each participants' tagging results as an externalization of their knowledge and memory structures as well as Sen et al.'s (2006) trend analytic method to discover the temporal features of a user's tagging tendency for applying pre-used or new tags.

2. Literature Review

2.1 User interface effects on tag selection

User interface can provide visual clues (e.g., size, color, and link) to assist users in discovering hidden information patterns and relations among concepts, retrieving information accurately and efficiently, as well as alleviate their demand on cognitive load (Gao, 2011). Regarding tagging mechanism, most of the user interfaces put the pre-used tags in order or visualize them in certain ways for future use. Therefore, in the future tagging process, a user can create a new tag for a new resource, or select (apply) a pre-used tag from the user interface.

The study implemented three kinds of user interfaces for tagging, including tag list, tag cloud, and tag network. The tag list method places tags in alphabetical order, or permutes them by their frequency (i.e., reused times, Halvey & Keane, 2007). The tag cloud method highlights tags in larger font size on a two-dimensional plane according to the reused times of tags. Lohmann, Ziegler, and Tetzlaff (2009) applied the eye-tracking method to investigate how their participants looked at the different tag cloud layouts. The eye tracking data showed that the participants not only had more eye fixations on large font size tags on the middle of the plane, but also tended to have fixations on upper left quadrant of all user interfaces. Gao (2011) classified methods of generating tag cloud into two types: according to the tag reused frequency or the tag semantic relation. We adopted reused times of tags to construct tag cloud in this study.

Based on the viewpoint that network structure can represent information organization structure (Marshall, 1990; Wyman & Randel, 1998), when a pair of tags is applied to a digital resource, it can be said that the pair of tags has a co-occurring relation between them, which can be represented by two nodes (Shen & Wu, 2005; Gao, 2011). Tags can also be viewed as concepts in human physical memory, and relations among them can be regarded as links among concepts for future retrieval. Therefore, the tags and their co-occurring relations can be visualized as tag networks, which help users to discover new concepts through connected links. For example, by network representation, social bookmarking services such as *citeulike*, *Diigo*, or *del.icio.us* recommend related articles with shared tags to users (Wu, Gordon, & Demaagd, 2004; Shen & Wu, 2005; Hsieh & Chiu,

2011). Stefaner has designed a network-based navigator allowing users to traverse the URLs on the social bookmarking service del.icio.us¹.

With regard to the evaluation of user interface usability, most of the previous studies put their emphasis on evaluating the usability of tag cloud. While evaluating the tag cloud usability on social networking, Sen et al. (2006) calculated the changes of new tag proportion to discuss how the pre-used tags affect future tag selection for movies. Gao's (2011) study resized the tag font size according to its pre-used frequency to assist future tag selection. It showed that the use of tag cloud interface can increase the wording consistency and therefore "*alleviate the physical demand perceived by users*" (Gao, 2011, p. 821).

2.2 Tag structural indicator

Since Marshall (1990) indicated that network indicator such as centrality and connectivity can be used to evaluate a user's knowledge structure and recall strategy, there has been several research works applying network analysis method to the investigation of tagging results. For example, while Cattuto, Barrat, Baldassarri, Schehr and Loreto (2009) focused on tag network dynamics, Shen and Wu (2005) employed network analysis indicators to show the structural properties of tag networks. The network indicators included degree distributions, clustering coefficients, and average path length. Hsieh and Chiu (2011) commented that the proportion of adding new tags or applying pre-used tags may affect the future network structure, which is corresponding to Sen et al.'s (2006) analytic method. Viewing tag results as networks, Kipp and Campbell (2006) investigated 64 popular URLs' tags and found that the usage of tags follows the long-tail phenomenon, which means that several tags will be reused heavily. Heymann and Garcia-Molina (2006) found that most of the users labeled resources in intuitive ways, not in logical or systematical ways, which increased the difficulty of future retrievals. Therefore, they applied the concepts of agreement, density and overlapping to generate hierarchical tag networks, and pointed out that the centrality, a network indicator, played an important role in re-constructing the hierarchical tag network.

Cattuto et al. (2009) and Schmitz et al. (2007) investigated how the change of tag network size affects that of the average path length, cliqueness, and connectedness. They believed that the social bookmarking shows collective dynamics, not a forehand and planned behaviors. Both of the studies discovered small world properties of tag networks. While the above studies used network analysis to show tag dynamics and tag results, evaluations for quantifying the tag networks are needed to predict future information organization efficacy (Pak, Pautz, & Iden, 2007). Pak et al. (2007) also commented that tagging mechanism often generated many item-specific terms, which may increase the working load of memory. The hierarchical categorization based on folder archiving has been evaluated by breadth and depth for more than one decade (Jacko & Salvendy, 1996; Zaphiris, 2000). Gao (2011) also proposed that consistent wordings will increase the usability of the whole system. In other words, a good user interface for tagging should lead users to reuse pre-used tags, rather than adding new tags endlessly.

3. Methods

3.1 System Design

To explore the effects of user interface on tagging mechanism, the researchers designed a tagging system to which instructors can upload three kinds of learning resources, including URLs, figures and PDFs, change the order of learning resources, and control the user interface displayed to students. Once an experiment is finished, instructors can download the log and take a quick view on the tagging results in the forms of both tag cloud and tag network provided by the system. Participant id, article id, tag, and timestamp were recorded in the log for future analysis.

Figure 1 illustrates the user interface for students to read a URL and tag it by adding new tags or applying pre-used tags on "Tag UIs". Three user interfaces (see Figure 2) were designed to assist tagging activities. Students were assigned different user interfaces according to their classes. Tag list

¹ http://well-formed-data.net/experiments/tag_maps/

in Figure 2 lists the tags in alphabetical order and attaches a number to each tag to indicate its reused frequency. Tag cloud visualizes the reused times of tags with different font sizes. High frequency tags are displayed in large font size. A link in a tag network further visualizes co-occurring times of a pair of tags. Whenever a student adds a new tag or reuses an old one, the user interface will be updated immediately. Furthermore, students can click a tag on tag cloud or tag network interfaces to apply it to the target URL. We utilized Force-Direct algorithm developed by Kamada and Kawai (1989) and Fruchterman and Reingold (1991) to visualize the tagging network.



Figure 1. The tagging user interface including the reading material, tagging area, and user interface (Tag UIs) for tagging activities.

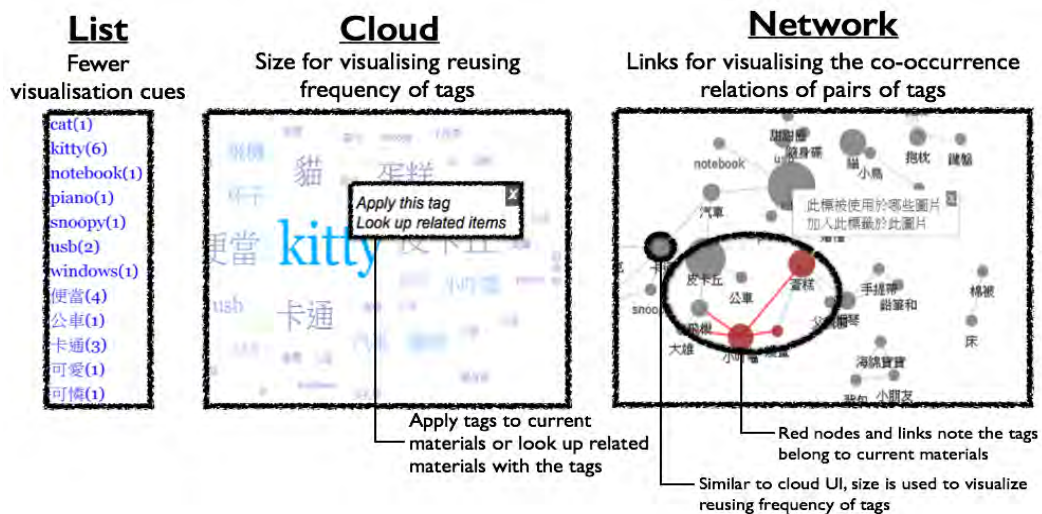

Figure 2. Examples of tag list, cloud, and network for tagging activities.

3.2 Experiment Designs

To investigate the effects of user interfaces on information organization, three classes from a vocational school in northern Taiwan were selected purposefully. Participants of the three classes belong to three different branches irrelevant to information science. The experiments were conducted in the course “Introduction to Computer Science,” where the three classes were assigned to use tag list ($n = 40$), tag cloud ($n = 31$) and tag network ($n = 34$) as experimental groups.

The materials used were 30 computer science related online articles selected by researchers and course teachers from three Taiwanese websites (i.e., *techorange.com*, *inside.com.tw*, and *wired.tw*). The topics of these articles cover the issues including social networking sites, mobile phones and apps, as well as network marketing, tools, and online startup.

For each class, the authors first introduced the concept of information organization and demonstrated the tagging system for 40 minutes. After that, the participants played a labeling game designed by the authors for 20 minutes and were encouraged to use several terms to describe the

characteristics of their classmates. Finally, the participants were requested to read and tag the 30 articles in 90 minutes. The authors taught these courses by ourselves and the original course instructor remained in the classroom for assistance.

The system recorded (article, tags, timestamp) entries for each tag adding operation. Besides, with the consent of the course instructor and students, the authors used digital video recorder to record the teaching process and student responses. After the experiments, several participants' logs were filtered out due to meaningless tags in their logs (e.g., "aaaaa", "123", "44444"). The final effective samples are 36, 28, and 29 participants for tag list, tag cloud and tag network respectively.

Each participant's tagging result was visualized as tag network for further comparison. In addition to descriptive analysis, on the basis of Marshall's (1990) viewpoint on information organization and Sen et al.'s (2006) analytic method, we recognized "reused times of tags" as an important factor that can be analyzed with three indicators. The first one is the number of distinct tags used by a participant. The tendency of adding new tags to label learning resources will lead to a higher number of distinct tags. The second indicator calculates the reused times of the highest frequency tag. For example, a participant was found to label all 30 articles with the tag "technology". His/her reused times of the highest frequency tag would be 30, which means that the participant considered the tag "technology" the core concept during the experiment. It should be noted that labeling all learning resources with the same tag hardly makes significant differences between them, and leads to a less effective information organization.

In addition to the indicator quantifying the use of highest frequency tag, we employed Hirsch's (2005) *h*-index as the third indicator to quantify middle frequency tags. The use of middle frequency tags can be viewed as a means to show the general characteristics of learning resources, while the use of low frequency tags to show the specific characteristics. The *h*-index, known for its avoidance of extreme value, was originally created to analyze the productivity and impact of a scholar (Hirsch, 2005). The original definition of *h*-index is that a scholar has index *h* if *h* of his/her papers have been cited at least *h* times. The application of *h*-index in our study for evaluating a user's behavior of reusing tags can be that if *h* of the tags has been reused at least *h* times, the user receives an *h* value as the quantifying value of his/her use of middle frequency tags.

Since tagging mechanism is an information organization method, there may not be a clear correlation between information organization and learning efficacy. Therefore, rather than evaluating the results of learning performance, we conducted a recall test with 15 items to assess the influence of tagging on recall efficacy. One sample item is "Please indicate that which option is the 2011 restaurant recommendation service based on atmosphere."

4. Results

4.1 Descriptive analysis

Table 1 shows the descriptive results of the three experimental groups (i.e., tag network, tag cloud, and tag list). On average, participants of the tag cloud group used the fewest tags to label the learning resources with a low standard deviation. Comparing the total number of tags and that of distinct tags, we found that the experimental groups using tag interfaces of list and cloud tend to reuse pre-used tags. Also, participants of the tag cloud group have a higher average of reused times of the highest frequency tags and *h*-index than the other two groups, which means that tag cloud can lead users to generate more high and middle frequency tags. According to the concept of information organization, high and middle frequency tags, compared with low frequency tags, can better reflect the main topics of the learning resources.

Correlations of the three indicators for evaluating different levels of reusing tag frequency are shown in Table 2. Both *h*-index and reused time of the highest frequency tags have a significantly negative correlation with the number of distinct tags in all three experimental groups, which means that the behavior of reusing tags may decrease that of creating new tags. The experimental group using tag cloud had the highest significantly negative correlation between the number of distinct tags and the other two indicators. (-0.87*** and -0.72***).

Table 1. Descriptive results of the tags used in the three different user interfaces (total number of articles is 30).

		Mean	Median	Max.	Min.	Std.
Total number of tags	Network	170.37	157	286	145	33.25
	Cloud	155.07	151.5	185	139	10.19
	List	165.77	158	298	101	30.92
Number of distinct tags	Network	142	143	286	85	39.99
	Cloud	108.1	109.5	156	24	31.48
	List	124.8	132	258	12	50.32
Reused time of the highest frequency tags	Network	10.00	6	30	1	8.45
	Cloud	11.43	10	29	2	6.85
	List	11.18	12	30	1	6.92
<i>h</i> -index of middle frequency tags	Network	4.12	3	7	1	1.54
	Cloud	4.97	4	8	2	1.52
	List	4.41	3	9	1	1.93

Table 2. Correlation among reused time of the highest frequency tags, *h*-index, and number of distinct tags in three user interface experiment groups.

	Network	Cloud	List
Number of distinct tags vs. <i>h</i> -index	-0.71 (<i>t</i> =-5.30***)	-0.87 (<i>t</i> =-9.16***)	-0.63 (<i>t</i> =-4.95***)
<i>h</i> -index vs. reused times of the highest frequency tags	0.71 (<i>t</i> =3.06***)	0.56 (<i>t</i> =3.45**)	0.672 (<i>t</i> =5.44***)
Number of distinct tags vs. reused times of the highest frequency tags	-0.50 (<i>t</i> =5.30***)	-0.72 (<i>t</i> =-5.30***)	-0.561 (<i>t</i> =-4.07***)

4.2 Visualization and Structural Analysis

By visualizing the tagging results as network structures, we named Hsieh et al.'s (2008) two types of tag networks as centralized and separated networks, and further added the third type in the current study as clustered network, as shown in Figure 3. The three networks are defined as follows: 1) a tag network is categorized as a “separated network” when it has more than 10 disconnected subcomponents; 2) a tag network is categorized as a “centralized network” when one or two of its tags has been applied for more than 20 learning resources; 3) if a tag network belongs to neither of the previous cases, it will be categorized as a “clustered network.” Centralized networks should have high reused times of the highest frequency tags but low *h*-index, while clustered networks have relatively high *h*-index. On the contrary, both indicators in separated networks should be low. With a focus on 3 to 4 main topics, the knowledge structure of learning resources in the study are believed to be better represented by clustered networks, as shown in Figure 3. The proportions of final tag network structures of the three experimental groups are shown in Table 3. The result indicates that participants using tag cloud interface created more clustered networks, while those using tag network interface created more separated networks.



Figure 3. Three typical structures of tag networks: centralized, clustered, and separated.

Table 3. Network visualization results of each user interface.

	Network	Cloud	List
Centralized	4 (13.8%)	2 (7.1%)	3 (8.3%)
Clustered	7 (24.1%)	16 (57.1%)	18 (50.0%)
Separated	18 (62.1%)	10 (35.7%)	15 (41.7%)

4.3 Sequential Analysis

By recording timestamps of the tagging activities, we can conduct a trend analysis on the tagging process. We defined the “new tag proportion” for each article as the number of new tags divided by the total number of tags. An example (3, 0.8) denotes that a participant added four new tags and applied one pre-used tag for the 3rd article. According to the results shown in Figure 4, line charts of the three experimental groups show valleys at 12th, 16th, and 19th, and peaks at 11th, 13th, and 18th learning resources. Those valleys indicate that most of the participants happen to apply pre-used tags on these articles. Since the articles appeared in the same order, the consistency of tag usage among participants shows that they have followed the instruction and taken the tagging task seriously. Besides, the average number of new tags decreases in the process of the tagging experiment, especially in the experimental group using tag cloud interface, which means that tag cloud interface has relatively effective influences on leading users to use more pre-used tags.

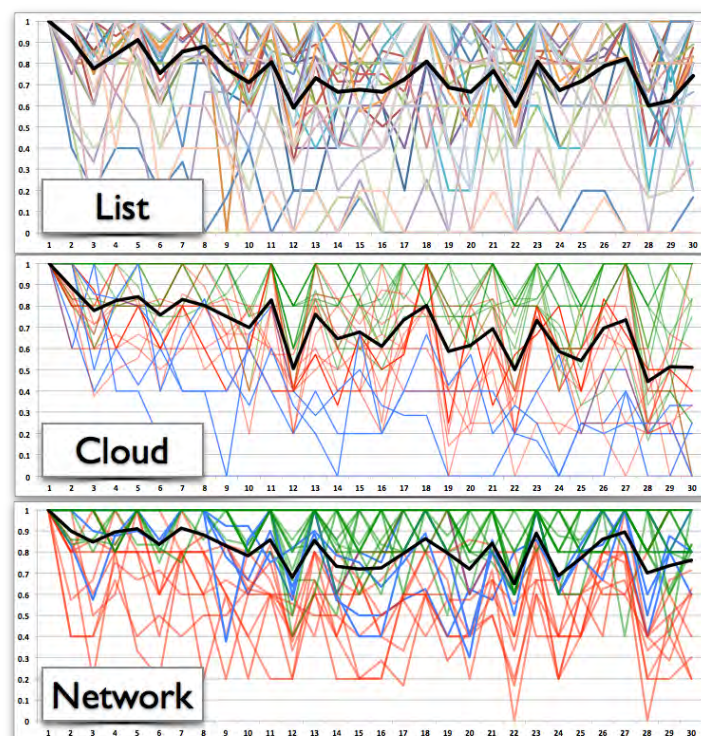

Figure 4. Line charts of the new tag proportion in the three user interfaces. Each line represents a participant’s tagging behavior.

While the above line charts displayed the difference of new tags used in the tagging process, they could not show that of the use frequency of pre-used tags. Therefore, the equation shown in Figure 5 is used to weight the score by tags’ reused times (t stands for each tag in an article p). k -mean algorithm was applied to cluster the lines into three groups colored by blue, red, and green. An interesting observation is that, in all the three experimental groups, the clustered weighted reused times seem to be a good factor to predict the final tag network structure (i.e., centralized, clustered, and separated network structures as shown in Figure 5).

It means that, if we recognized that the clustered network structure is a better information organization, we can predict the final structure of users' tagging behaviors according to their early tagging activities, and provide them useful suggestions to help them organize their materials more effectively and efficiently.

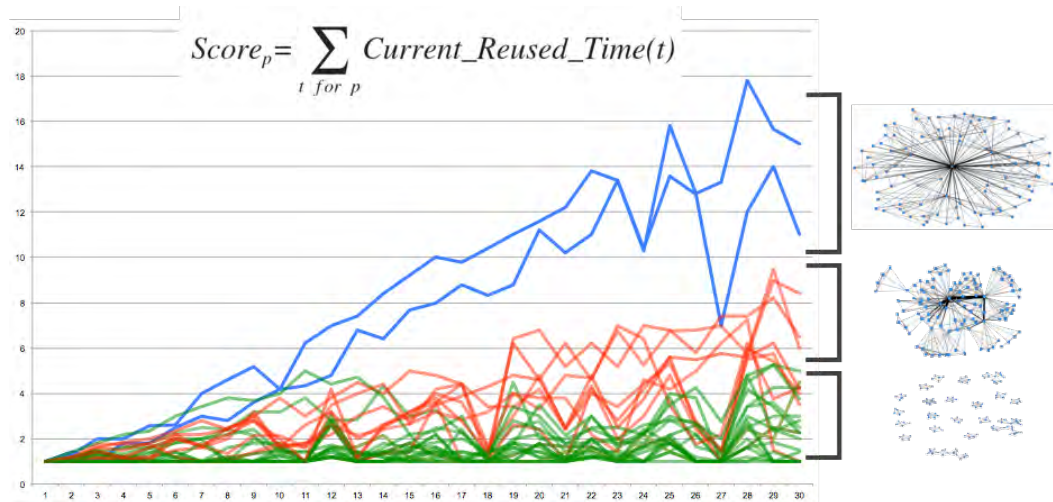

Figure 5. The results of weighted pre-used tags by reused times. Blue, red and green stand for the result of k -mean clustering algorithm ($k = 3$). The three clusters match the network representation of final tagging results on the right side.

5. Conclusion and Discussion

The study designed different user interfaces to assist our participants in the tagging activities, and investigated their effects on the tagging behaviors. Significant effects were found in the descriptive results and trend analysis of the reused frequency of tags. Furthermore, in terms of information organization, tag cloud interface serves as a better guide for the participants to reuse pre-used tags. Although the tag network interface provides more visual clues, too much information on it failed to help the participants to reuse pre-used tags or improve the wording consistency of tags.

Based on the concept of network-based indicators for evaluating information organization by Marshall (1990), we adopted Shen and Wu's (2005) idea to turn final outcomes of tagging activities into network structures for further observation. Three types of networks, centralized, clustered, and separated, were used for categorization of the tagging results. We found that the tag cloud group had more clustered networks than the other two groups. The clustered type of network means that participants found multiple topics from the learning resources, which are corresponding to those selected by the researchers and the course teacher. Unlike the tag cloud group, participants using the tag network interface tended to create many disconnected subcomponents, suggesting that the tag network interface designed in the study cannot help participants to organize their information well. Combining the observation on network structures and the trend analysis, we found that weighting the reused times of tags can predict the network structures of final tagging outcomes. A possible future work is, based on the reused times of tags, we can design a tag recommendation mechanism to guide users to construct a better information organization structure for future navigation.

Nevertheless, the limitation of the study was due to the experiment method. The tagging activities on a bookmarking system in real life should be a long-term behavior. Since the participants were requested to finish the task in 90 minutes on our designed system, the results could be bias due to the system design and time limits. For example, the tag network interface has richer information clues than the other interfaces, and therefore takes more time

to understand and become familiar with it. With a time limit, rich information clues may demand additional cognitive load.

References

- Bergman, O., Beyth-Marom, R., & Nachmias, R. (2008). The user-subjective approach to personal information management systems design: Evidence and implementations. *Journal of the American Society for Information Science and Technology*, 59(2), 235-246.
- Bergman, O., Gradovitch, N., Bar-Ilan, J. & Beyth-Marom, R. (2013a), Tagging personal information: A contrast between attitudes and behavior. *Proceedings of the American Society for Information Science and Technology*, 50, 1-8. doi: 10.1002/meet.14505001029
- Bergman, O., Gradovitch, N., Bar-Ilan, J., & Beyth-Marom, R. (2013b). Folder versus tag preference in personal information management. *Journal of the American Society for Information Science and Technology*, 64(10), 1995-2012.
- Brand-Gruwel, S., Wopereis, I., & Vermetten, Y. (2005). Information problem solving by experts and novices: Analysis of a complex cognitive skill. *Computers in Human Behavior*, 21(3), 487-508.
- Brown, A. L. (1987). Metacognition executive control, self-regulation, and other more mysterious mechanisms. In F. E. Weinert & R. H. Kluwe (Eds.), *Metacognition, motivation, and understanding* (pp. 65-116). Hillsdale, NJ: Erlbaum.
- Cattuto, C, Barrat, A, Baldassarri, A, Schehr, G, & Loreto, V. (2009). Collective dynamics of social annotation. *Proceedings of the National Academy of Sciences*, 106(26), 10511-10515.
- Civan, A., Jones, W., Klasnja, P., & Bruce, H. (2008). Better to organize personal information by folders or by tags?: The devil is in the details. *Proceedings of the American Society for Information Science and Technology*, 45(1), 1-13.
- Estellés, E., González, F., & del Moral, E. (2010). Social bookmarking tools as facilitators of learning and research collaborative processes: The Diigo Case. *Interdisciplinary Journal of E-Learning & Learning Objects*, 6, 175-191.
- Fruchterman, T.M.J. & Reingold, E.M. (1991). Graph drawing by force-directed placement. *Software-Practice & Experience (Wiley)*, 21(11), 1129-1164.
- Gao, Q. (2011). An empirical study of tagging for personal information organization: Performance, workload, memory, and consistency. *International Journal of Human-Computer Interaction*, 27(9), 821-863.
- Halvey, M. J., & Keane, M. T. (2007, May). An assessment of tag presentation techniques. *Proceedings of the 16th international conference on World Wide Web* (pp. 1313-1314). New York, NY: ACM.
- Heymann, P., & Garcia-Molina, H. (2006). *Collaborative creation of communal hierarchical taxonomies in social tagging systems (Stanford InfoLab Technical Report 2006-10)*. Retrieved from Stanford InfoLab Publication Server: <http://ilpubs.stanford.edu:8090/775/1/2006-10.pdf>
- Hirsch, J. E. (2005). An index to quantify an individual's scientific research output. *Proceedings of the National Academy of Sciences*, 102(46), 16569-16572.
- Hsieh, J. L., Chen, C. H., Lin, I. W., & Sun, C. T. (2008). A Web-based tagging tool for organizing personal documents on PCs (Position Paper), *Position Paper of Workshop of Personal Information Management (PIM) in CHI'08*, Florence, Italy.
- Hsieh, J.L. & Chiu, L.C. (2011). Network analysis of tagging structure. *Proceedings of the American Society for Information Science and Technology*, 48(1), 1-4. New Orleans, LA. doi: 10.1002/meet.2011.14504801233
- Im, T., & Dennen, V. (2013, October). Building a collaborative knowledge base in Diigo: How links, tags, and comments support learning. *Proceedings of World Conference on E-Learning in Corporate, Government, Healthcare, and Higher Education*, 2013(1), 794-797. Las Vegas, NV.
- Jacko, J. A., & Salvendy, G. (1996). Hierarchical menu design: Breadth, depth, and task complexity. *Perceptual and Motor Skills*, 82(3c), 1187-1201.
- Kamada, T. & Kawai, S. (1989) An Algorithm for Drawing General Undirected Graphs. *Information Processing Letters*, 31, 7-15.
- Kipp, M.E.I., & Campbell, D.G. (2006). Patterns and inconsistencies in collaborative tagging systems: An examination of tagging practices. *Proceedings of the American Society for Information Science and Technology*, 43(1), 1-18. Austin, TX. doi: 10.1002/meet.14504301178
- Liu, E. Z. F., & Chang, Y. F. (2008). The learning opportunities of social bookmarking service: An example of funP. *WSEAS Transactions on Systems*, 7(10), 1198-1205.
- Lohmann, S., Ziegler, J., & Tetzlaff, L. (2009). Comparison of tag cloud layouts: Task-related performance and visual exploration. *Human-Computer Interaction-INTERACT 2009* (pp. 392-404). Springer Berlin Heidelberg.

- Maggio, L. A., Bresnahan, M., Flynn, D. B., Harzbecker, J., Blanchard, M., & Ginn, D. (2009). A case study: using social tagging to engage students in learning Medical Subject Headings. *Journal of the Medical Library Association: JMLA*, 97(2), 77-83. doi:10.3163/1536-5050.97.2.003
- Marshall, S. P. (1990). Generating good items for diagnostic tests. In N. Frederiksen, R. Glaser, A. Lesgold & M. Shafto (Eds.), *Diagnostic monitoring of skill and knowledge acquisition* (pp. 433-452). Hillsdale, NJ: Erlbaum.
- Pak, R., Pautz, S., & Iden, R. (2007). Information organization and retrieval: A comparison of taxonomical and tagging systems. *Cognitive Technology*, 12(1), 31-44.
- Schmitz, C., Grahl, M., Hotho, A., Stumme, G., Cattuto, C., Baldassarri, A., ...Servedio, V.D.P. (2007). Network Properties of Folksonomies. *Tagging and Metadata for Social Information Organization; a workshop at WWW2007*, Banff, Alberta, Canada.
- Sen, S., Lam, S. K., Rashid, A. M., Cosley, D., Frankowski, D., Osterhouse, J., ...Riedl, J. (2006, November). Tagging, communities, vocabulary, evolution. *Proceedings of the 2006 20th anniversary conference on Computer supported cooperative work* (pp. 181-190). New York, NY: ACM.
- Shen, K., & Wu, L. (2005). Folksonomy as a Complex Network. *arXiv: Computer Science*. Retrieved November 7, 2010, from <http://arxiv.org/pdf/cs.IR/0509072>.
- Wyman, B., & Randel, J. (1998). The relation of knowledge organization to performance of a complex cognitive task. *Applied Cognitive Psychology*, 12, 251-264.
- Walraven, A., Brand-Gruwel, S., & Boshuizen, H. (2008). Information-problem solving: A review of problems students encounter and instructional solutions. *Computers in Human Behavior*, 24(3), 623-648.
- Wu, H., Gordon, M. D., & DeMaagd, K. (2004, April). Document co-organization in an online knowledge community. *CHI'04 Extended Abstracts on Human Factors in Computing Systems* (pp. 1211-1214). New York, NY: ACM.
- Zaphiris, P. G. (2000, July). Depth vs Breath in the Arrangement of Web Links. *Proceedings of the Human Factors and Ergonomics Society Annual Meeting*, 44(4), 453-456. London: SAGE Publications.

Study on Pass-Fail Prediction for the National Radiological Technologist Examination by Discriminant Analysis Using Mock Examinations

Hiro Yoshi WATANABE^{a*}, Shigeru SASAKI^b, Shinsuke AIKO^b & Shigemi SAKAMOTO^c

^a*Learning Technology Laboratory, Teikyo University, Japan*

^b*Graduate School, Teikyo University, Japan*

^c*Nihon Institute of Medical Science, Japan*

*hiro@ics.teikyo-u.ac.jp

Abstract: The objective of this study was to establish a technique for pass-fail prediction for a national examination from the results of intramural mock examinations, for practical use within a school. At the initial stage, we performed pass-fail prediction by discriminant analysis using intramural mock examination and national examination results for the national radiological technologist examination over a period of one year at a certain school. Specifically, we carried out experiments to investigate the optimal attributes and techniques for prediction by discriminant analysis using the Mahalanobis distance. It was found that the correct identification rate was higher when using the scores obtained in 14 subjects than when using the total of the scores of a mock examination as an attribute. Moreover, the method of dividing the national examination results into two or more groups, conducting discriminant analysis, and performing pass-fail prediction based on those results was determined to be effective. The predictive accuracy of discriminant analysis performed directly on two pass-or-fail groups was 84.3%. On the other hand, the accuracy of pass-fail prediction based on the results of discriminant analysis of five groups was 89.3%, providing a higher predictive accuracy than the former method.

Keywords: Pass-fail prediction, discriminant analysis, national examination, radiological technologist

1. Introduction

National qualifications are required in order for health professionals to perform their work in Japan. It is important for medical schools to have all students pass a national certification examination. In reality, however, not every student passes the examination. There are various reasons for this. To improve this situation, the schools need to provide effective education while assisting individual students to design an appropriate learning program and maintaining their motivation. We focused on educational guidance based on pass-fail predictions for a national examination. This guidance approach allows students, based on pass-fail predictions, to increase awareness of their goals and design an appropriate learning program at the early stages of preparation for the examination. It also allows them to make preparations for the examination while modifying the learning program based on pass-fail predictions conducted on a regular basis. Currently, pass-fail predictions for national examinations are often carried out intuitively based on the experience of faculty members. Data-based objective predictions are considered to be useful in these circumstances.

In the United States, there is a large-scale examination called HESI Exit Exam (E²) which has been administered by over 600 schools in 50 states (Langford & Willson 2012; Langford & Young, 2013). The study indicated that the accuracy of E² in predicting National Council Licensure Examination for Registered Nurses (NCLEX-REN) success is very high (96.36%-99.16%) and the E² scores are useful as a benchmark. Unfortunately, there is not such examination for most medical technologist qualification in Japan.

The objective of this research is to develop a method for making pass-fail predictions for a national examination from the results of intramural mock examinations, with utilization by a single school in mind. The national radiological technologist examination was used as an example in this study. As the first step in the development of the method, we evaluated pass-fail predictions by discriminant analysis using intramural mock examination and national examination data collected over a period of one year. Specifically, we studied the attributes to be used and the optimal method of making predictions.

In a study related to pass-fail predictions for national examinations for health care professionals, Richard et al (2004) analyzed the background and scholastic data of undergraduate nursing student who had graduated from a nursing school. They found that gender, age, Scholastic Aptitude Test (SAT) verbal, SAT quantitative and Cumulative Nursing GPA were significantly different between students who had passed NCLEX-REN and students who had not. They created a discriminant function to predict success on NCLEX-REN and the overall hit rate for this function was 70.1%. Truman (2012) compared graduates of a specific rural associate degree nursing program who had been successful on the initial attempt at NCLEX-REN to graduates who had not. As results, it was revealed that Scholastic Aptitude Test (SAT) verbal and nursing GPA significantly predicted NCLEX-RN success.

Miyashita et al (2004) compared average scores in examinations for enrolment in a higher year of study, average grades for 24 subjects in a course-specific graduation examination (course graduation examination), scores in mock examinations for a national examination (prep-school examinations), and scores in a comprehensive final-year examination for final sixth-year students (comprehensive examination) with scores for the national medical practitioners examination, and showed that there is a strong correlation between scores in the prep-school and comprehensive examinations and those in the national examination, indicating that the mock examinations and comprehensive examinations are suitable for predicting scores in the national examination. The previous studies suggest that pass-fail predictions for a national examination can be made more accurately from scores in mock examinations than from those in subject examinations.

Miyamoto et al. (2008) made pass-fail predictions for a national examination from scores in graduation examinations conducted by schools of medicine. The correct pass-fail identification rate for each year ranged from 82.7 to 97.2%. The correct pass-fail identification rate based on the overall average was 91.2%. The rate predicted for the following year using the discriminant for the year of interest ranged from 82.7 to 92.0%, and the overall average was 88.1%. While Miyamoto et al. made predictions from scores in the graduation examination; we evaluated pass-fail predictions, which are used for guidance provided about six months prior to graduation. In addition, we improved the accuracy of the pass-fail prediction by dividing scores in national examination into several groups.

2. Target National Examination and Data Used, and Outline of the Experiments

2.1 Target National Examination

The national examination used in this study was the national radiological technologist examination, described below.

- Held once a year, in February
- Number of questions: 200
- Pass criteria: 60% (120 points) or more and not more than one subject with a score of zero
- Question type: Marked sheet examination in which students select one correct answer from five choices
- 14 examination subjects: General basic medicine, radiation biology (including radiation hygiene), radiological physics, radiochemistry, medical engineering, diagnostic imaging equipment, X-ray photography, diagnostic imaging examination, image engineering, medical imaging informatics, radiation measurement, nuclear medicine examination techniques, radiation therapy techniques, and radiation safety management

2.2 Data Used

The data used in this study were the results of seven intramural mock examinations (including the graduation examination) and the national examination taken by the students graduating from a school in 2011. The data were processed in such a manner as to prevent information from being identified with a particular school and students. We obtained permission for the use of the data for research purposes under the following conditions:

- The data must be modified (student names to be removed and student numbers converted to IDs that cannot be identified with a particular student).
- Information on the source of the data (school name, information provider, number and percentage of students who passed the national examination) must not be disclosed in the results of the study.

An intramural mock examination is prepared by the faculty members. The question type and the number of questions in each subject are the same as those in the national examination. The maximum score is 200 points for both examinations.

A score in each subject is recorded for the mock examination. The total score obtained by post-examination self-assessment is recorded for the national examination. For the national examination, pass and fail information is released by the Ministry of Health, Labor and Welfare, but scores are not released. Therefore, the self-assessed total scores were used for analysis.

2.3 Outline of the Experiments

Pass-fail predictions for the national examination were made by Mahalanobis distance-based discriminant analysis. In a future study, we will obtain information on the probability of individual students passing the national examination and information that can be used to instruct students on which subjects they need to focus on. We will also make pass-fail predictions from the most current results every time a mock examination is conducted. To achieve this, we will make it possible to conduct predictions for each mock examination, instead of making predictions after the results of seven mock examinations become available. The experiments and their objectives are described below.

- Experiment 1: Discriminant analysis of the results of each mock examination. In this experiment, the attributes to be used were determined by comparing two methods for the analysis of mock examination results: a method using a score for each of the 14 subjects and a method using the total score. Moreover, trends in pass-fail predictions from the results of seven mock examinations were identified.
- Experiment 2: Discriminant analysis of the results of all seven mock examinations. The aim of this experiment was to determine the usefulness of pass-fail predictions from the results of all mock examinations as a means of pass-fail prediction for each mock examination.
- Experiment 3: Pass-fail predictions made by dividing national examination results into several groups. In this experiment, it was determined whether national examination results can be predicted at a detailed level. It was also determined whether the accuracy of pass-fail prediction can be improved by making pass-fail predictions from detailed predictions of examination results.
- Experiment 4: Pass-fail predictions without the use of mock examination data in the same session. Mock examination data in the same session as for the prediction sample cannot be used to make pass-fail predictions. Therefore, a similar experiment to Experiment 3 was performed without the use of mock examination data in the same session.

The free statistics software “R” (version R3.0.0) was used for statistical processing. In the discriminant analysis, the equality of the variance-covariance matrix between the pass and fail groups was tested at a significance level of 5%. In the case of equal variance, the Mahalanobis distance was calculated by pooling the variance.

The methods and results of Experiments 1 to 4 are described and discussed in the following sections.

3. Experiment 1: Discriminant Analysis of the Results of Each Mock Examination

First, we focused on the score for each of the 14 subjects and the total score (the sum of the scores for the 14 subjects) to determine the attributes of the intramural mock examination results to be used to effectively determine a pass or fail in the national examination. We performed discriminant analysis with different combinations of these attributes and determined the combination of attributes that gave a high correct identification rate.

3.1 Method

3.1.1 Data Preparation

Data on the results of each examination were prepared as shown in Table 1. The pass-fail attribute is A for a score of 120 or higher (pass) and B for a score of 119 or lower (fail).

Table 1: Example of a data set for Experiment 1

Sample No.	Subject 1	...	Subject 14	Total score in mock exam	Total score in national exam	Pass-fail (group)
1	6	...	11	116	135	A
2	3	...	7	95	119	B
3	5	...	8	125	120	A
4	5	...	10	119	95	B
⋮	⋮	⋮	⋮	⋮	⋮	⋮
n	8	...	10	138	141	A

3.1.2 Testing of Equal Variance

A method for testing the equality of the variance-covariance matrix with the statistics software “R” was applied to obtain the p value. The p values for the seven mock examinations ranged from 0.107 to 0.947. The variance-covariance matrix was determined to be equal between Groups A and B. The variance was pooled to calculate the Mahalanobis distance.

3.1.3 Procedure

The following steps were performed on the data for the first to seventh mock examinations using the score for each of the 14 subjects (14 attributes) and the total score (one attribute).

The Mahalanobis distance from the average for Group A and from the average for Group B was calculated for each sample in Table 1. Predictions were made using the data for the group with a shorter distance as the data set. The results of the predictions were compared with the actual data set for the group, and the number of correct predictions was counted. The correct identification rate was obtained by dividing the number of correct predictions by the total number of data sets.

Table 2: Results of discriminant analysis for each mock examination

Mock Exam \ Attribute	1 st exam	2 nd exam	3 rd exam	4 th exam	5 th exam	6 th exam	7 th exam
14 Subjects	88.9	84.1	83.6	86.3	88.0	94.7	87.7
Total Score	63.9	71.0	64.2	67.1	57.3	69.3	66.2

3.2 Results

Table 2 shows the correct identification rate for each mock examination obtained using the score for each of the 14 subjects and the total score. As shown in this table, for all mock examinations, the

correct identification rate was higher when the score for each of the 14 subjects was used than when the total score was used.

The correct identification rate obtained using the 14 subjects as attributes gradually decreased for the first to third mock examinations, increased to a maximum of 94.7% for the sixth mock examination, and decreased for the seventh mock examination. In other words, the results show that the accuracy of the prediction is not higher for mock examinations closer to the date of the national examination.

3.3 Discussion

The results of Experiment 1 show that the score for each of the 14 subjects should be used as an attribute for discriminant analysis instead of the total score in a mock examination. The use of the score for each of the 14 subjects may make it possible to analyze which subjects each student should focus on.

From the results of Experiment 1, it is not clear whether the timing of the mock examinations affects the accuracy of the pass-fail prediction. We hypothesized that the accuracy of the pass-fail prediction would be higher for mock examinations closer to the date of the national examination because we considered that the competence of the students would be at a level where they were ready for the national examination. From Table 2, however, it can be seen that the accuracy of the prediction is not necessarily higher for mock examinations closer to the date of the national examination than for earlier mock examinations. This indicates that the accuracy may be more strongly affected by differences in the level of difficulty of the questions and similarity of the content of questions in the national and mock examinations than by proximity to the date of the national examination. There is a weak correlation between the number of examinations and the accuracy of predictions made using the score for each of the 14 subjects (correlation coefficient = 0.46). The accuracy of the prediction may also be affected by information on the date of the national examination.

4. Experiment 2: Discriminant Analysis of the Results of All Seven Mock Examinations

Based on the results of Experiment 1, the score for each of the 14 subjects, which resulted in a high correct identification rate, was used as an attribute. In Experiment 2, the results of all seven mock examinations were used for discriminant analysis. Two cases were analyzed: a case where the scores for each of the 14 subjects were used as attributes and a case where the number of days from the date of the mock examination to the date of the national examination, which comprises information indicating the timing of the mock examination, was added as an attribute (15 attributes in total).

Table 3: Example of a Data Set for Experiment 2

Mock exam	Sample No.	Subject 1	...	Subject 14	No. of days to national exam	Total score in national exam	Pass-fail (group)
1 st exam	1	6	...	11	210	135	A
	2	3	...	7	210	119	B
	⋮	⋮	⋮	⋮	⋮	⋮	⋮
	n_1	7	...	12	210	141	A
⋮	⋮	⋮	⋮	⋮	⋮	⋮	
7 th exam	n_6+1	5	...	10	30	135	A
	n_6+2	4	...	8	30	119	B
	⋮	⋮	⋮	⋮	⋮	⋮	⋮
	n_7	8	...	10	30	141	A

The number of the last sample before the m^{th} mock examination is represented by n_m .

4.1 Method

4.1.1 Data Preparation

Data on the results of all seven examinations were prepared as shown in Table 3. The number of days to the date of the national examination was added as an attribute. The number of days to the date of the national examination indicates how many days before the national examination the mock examination was conducted. The pass-fail attribute is A for a total score of 120 or higher (pass) and B for a total score of 119 or lower (fail) in the national examination.

4.1.2 Testing of Equal Variance

The method for testing the equality of the variance-covariance matrix with the statistics software “R” was applied to obtain the p value. As a result, the p value was 0.0129 for the score for each of the 14 subjects (14 attributes without the number of days to the national examination) and 0.0196 for those with the number of days included (15 attributes). The variance-covariance matrix was determined to be not equal between Groups A and B. Therefore, the variance was not pooled to calculate the Mahalanobis distance.

4.1.3 Procedure

As with Experiment 1, the correct identification rate was obtained using the data on all seven mock examinations in two cases: a case where the score for each of the 14 subjects was used (case without the use of the number of days) and a case where the score for each of the 14 subjects and the number of days to the date of the national examination were used (case with the use of the number of days).

4.2 Results

The correct identification rate was 88.1% in the case without the use of the number of days and 89.3% in the case with the use of the number of days. The accuracy of the prediction was slightly higher in the latter case.

4.3 Discussion

It was found that if the data for the results of all mock examinations were processed in a batch, the variance-covariance matrix of the mock examination results was not equal between the pass and fail groups. Therefore, the variance was not pooled to calculate the Mahalanobis distance.

The accuracy of the prediction was slightly higher in the case with the use of the number of days to the date of the national examination, which comprises information indicating the timing of a mock examination. However, it is not clear whether this information contributes to the accuracy of the pass-fail prediction due to the proximity to the date of the national examination. In this experiment, to make pass-fail predictions for a sample, mock examination data in the same session as for the sample were included in the data set. As a result, the effect of the mock examination data in the same session on the accuracy of the prediction increased due to the use of the number of days, and the possibility of correct predictions increased.

5. Experiment 3: Pass-fail Predictions Made by Dividing National Examination Results into Several Groups

In Experiments 1 and 2, discriminant analysis was performed on the pass and fail groups to determine the accuracy of the prediction. In Experiment 3, the number of national examination score groups was increased to make more detailed predictions of national examination results, and discrimination analysis (multiple discriminant analysis) was performed. The accuracy of pass-fail (two groups) predictions from the results of the analysis was evaluated.

5.1 Method

5.1.1 Grouping

Table 4 shows the grouping. The scores in the national examination were divided according to the number of groups, as shown in the table. That is, students were grouped by the range of their scores in the national examination shown in Table 4. For example, in the case of four groups, a score from 140 to 200 inclusive falls within Group A and a score of 130 to 139 inclusive falls within Group B.

In the case of two groups, students were divided into only two groups: passing students and failing students. In the case of three and four groups, passing students were divided into several groups. In the case of five groups, failing students were divided. The students were divided into groups so that the number of samples was not zero in any case.

Table 4: Range of the Score of Each Group

No. of Groups	Group A	Group B	Group C	Group D	Group E
2	200~120	119~0	-	-	-
3	200~135	134~120	119~0	-	-
4	200~140	139~130	129~120	119~0	-
5	200~140	139~130	129~120	119~110	109~0

Note: The painted score ranges indicate a pass.

5.1.2 Data Preparation

Data for the results of all seven examinations were prepared as shown in Table 5. The pass-fail attributes were grouped in the same manner as in Table 4. Table 5 shows an example of a data set in the case of five groups.

Table 5: Example of a data set for Experiment 3

Mock exam	Sample No.	Subject 1	...	Subject 14	Total score in national exam	Group
1 st exam	1	6	...	11	89	E
	2	3	...	7	119	D
	⋮	⋮	⋮	⋮	⋮	⋮
	n_1	7	...	12	141	A
⋮	⋮	⋮	⋮	⋮	⋮	⋮
7 th exam	n_6+1	5	...	10	89	E
	n_6+2	4	...	8	119	D
	⋮	⋮	⋮	⋮	⋮	⋮
	n_7	8	...	10	141	A

5.1.3 Procedure

As with Experiment 1, the correct identification rate was obtained for a different number of national examination score groups from 2 to 5 in two cases: the case where the score for each of the 14 subjects was used (case without the use of the number of days) and the case where the score for each of the 14 subjects and the number of days to the date of the national examination were used (case with the use of the number of days). In addition, pass-fail predictions were made for each group using Table 4. The predictions were compared with the actual pass-fail results, and the number of correct predictions was counted to determine the accuracy of the prediction.

5.2 Results

Table 6 shows the correct group identification rate and the correct pass-fail prediction rate for different numbers of national examination score groups. The group correct identification rate is the highest when the number of groups is 2 and decreases with an increasing number of groups. The

correct pass-fail prediction rate is higher for a larger number of groups and is the highest when the number of groups is 5. For all numbers of groups, the rate is slightly higher in the case with the use of the number of days.

Table 6: Results of Group Distinction and Pass-Fail Prediction

No. of Groups	Without No. of Days to National Exam		With No. of Days to National Exam	
	Group Distinction	Pass-Fail Prediction	Group Distinction	Pass-Fail Prediction
2	88.1	88.1	89.3	89.3
3	68.1	89.7	69.8	91.1
4	61.1	90.9	66.1	92.7
5	64.3	96.0	68.5	96.8

5.3 Discussion

The results of Experiment 3 show that if the number of national examination score groups is more than 2, the correct prediction rate based on score groups decreases. Therefore, it is difficult to use this method to make detailed predictions of examination results. Pass-fail predictions made based on the predicted groups are more accurate than those made based directly on the pass and fail groups. Particularly when the number of groups is 5, the correct prediction rate is at least 7 points higher than when the number of groups is 2. This indicates that pass-fail predictions based on the grouping of national examination results are useful.

As in Experiment 2, the accuracy of the prediction was slightly higher in the case with the use of the number of days to the date of the national examination in Experiment 3. However, as discussed in Section 4.3, whether to use the number of days to the date of the national examination as an attribute is an issue that needs to be examined.

6. Experiment 4: Pass-fail Predictions Without the Use of Mock Examination Data in the Same Session

Mock examination data in the same session as for the prediction sample cannot be used to make pass-fail predictions for a forthcoming national examination. The experiments conducted indicate (a) that the accuracy of pass-fail prediction increases due to the effect of the mock examination data in the same session and (b) that the accuracy of the prediction slightly improves because the effect of the data increases when the number of days to the date of the national examination is used. Therefore, a similar experiment to Experiment 3 was performed without the use of mock examination data in the same session as for the prediction sample.

6.1 Method

The grouping and data preparation were the same as in Experiment 3.

The following steps were performed for different numbers of national examination score groups from 2 to 5 in two cases: the case where the score for each of the 14 subjects was used (case without the use of the number of days) and the case where the score for each of the 14 subjects and the number of days to the date of the national examination were used (case with the use of the number of days).

The data in Table 5, excluding the first examination data, were used for discrimination. The Mahalanobis distance from the average for each group was calculated using discrimination data for each sample from the first examination. Predictions were made using the data for the group with the shortest distance as the data set. The results of the predictions were compared with the actual data for the group, and the number of correct predictions was counted for correct group discrimination. Pass-fail predictions were made based on whether the predicted group was a pass group or a fail group, and were compared with the actual pass-fail results. The number of correct predictions was counted for correct pass-fail predictions. The above steps were performed using the first to seventh

data sets. The correct group identification rate and the correct pass-fail prediction rate were obtained by dividing the number of correct group identifications and the number of correct pass-fail predictions by the total number of samples.

Table 7: Results of Group Distinction and Pass-Fail Prediction Without Mock Examination Data to Which the Target Sample Belonged

No. of Groups	Without No. of Days to National Exam		With No. of Days to National Exam	
	Group Distinction	Pass-Fail Prediction	Group Distinction	Pass-Fail Prediction
2	82.7	82.7	84.3	84.3
3	50.0	82.9	55.4	84.9
4	37.5	82.7	41.1	83.5
5	39.1	88.5	43.1	89.3

6.2 Results

Table 7 shows the results. Overall, the accuracy of the prediction was lower than in Experiment 3, in which all data were used. Unlike in Experiment 3, the correct pass-fail prediction rate did not necessarily increase with an increasing number of groups, but was the highest when the number of groups was 5. The accuracy of the prediction for all groups was slightly higher in the case with the use of the number of days.

6.3 Discussion

The correct prediction rate is about 5 points lower in the case without the use of mock examination data in the same session as that for the prediction sample, compared with the case in which the entire mock examination data are used. This indicates that the accuracy of the prediction will be 80 to 90% using discriminant analysis to make pass-fail predictions for the national examination. Since the level of difficulty of the questions in the national examination differs from year to year, we will continue to evaluate pass-fail predictions using data for several years.

The results of Experiment 4 indicate that the accuracy of the prediction slightly increases using the number of days from the date of the mock examination to the date of the national examination. This is because in Experiment 4, mock examination data in the same session as for the prediction sample were not used and the increased effect of the mock examination data in the same session on the accuracy of the prediction due to the use of the number of days did not occur.

7. Conclusions

In the initial stage of this study of pass-fail predictions for the national radiological technologist examination, we performed Mahalanobis distance-based discriminant analysis using data on examination results collected over a period of one year. Our analysis indicates that predictions can be made with an accuracy approaching 90% and has shown the following:

- The score for each of the 14 subjects in a mock examination should be used as a basic attribute.
- Pass-fail predictions can be effectively made by dividing national examination results into five groups.
- The number of days to the date of the national examination may be a useful attribute for pass-fail predictions.

Data collected over a period of two years will be available for a future study. We will evaluate the accuracy of the prediction by making pass-fail predictions for the following year using data for the current year. The next step is to make pass-fail predictions using other techniques such as multiple regression analysis, neural net analysis, and Bayesian analysis.

References

- Langford,R. & Willson,P. (2012) Predicting NCLEX-RN Success: The Seventh Validity Study of the HESI Exit Exam, *CIN: Computers, Informatics, Nursing*, 30, 55-60.
- Langford,R. & Young,A. (2013) Predicting NCLEX-RN Success With the HESI Exit Exam: Eighth Validity Study, *Journal of Professional Nursing*, 29(25), 55-59.
- Miyamoto, M., Mori, Y., Kubota, T., Nishimura, Y., & Yoneda, H. (2008). Expectation of Graduates' Pass-fail Possibilities on the National Examination by Discriminant Analysis of the Results on the Graduation and Integrated Examinations, *The Japanese Journal for Research on Testing*, 4(1), 34-39.
- Miyashita, T., Shimura, T., Adachi, K., Aramaki, T., Shimizu, K., & Dan, K.(2004). A Comparative Study of Undergraduate Examinations to Evaluate Medical Students' Performance and the National Examination for Medical Practitioners. *Journal of the Japanese Society for Medical Education*, 35(4), 281-285.
- Haas,R.E., Nugent,K.E., & Rule R.A. (2004) The Use of Discriminant Function Analysis to Predict Student Success on the NCLEX-REN, *Journal of Nursing Education*, 43(10), 440-446.
- Truman,J.M. (2012) Identifying Predictors of National Council Licensure Examination for Registered Nurses (NCLEX-RN) Success in an Associate Degree Nursing Program, *International Journal of Applied Science and Technology*, 2(7),37-45.

Altruistic behavior in a learning stage through social network

Shiang-Yi WANG*¹, Wang-Han LI¹, De-Yuan Huang¹, Chi-Wen Huang¹, Su-Hang Yang² & Gwo-Dong Chen¹

¹*Department of Computer Science and Information Engineering, National Central University, Taiwan*

²*Department of Hospitality Management, Chien Hsin University, Taiwan*

*shaingyi791205@gmail.com

Abstract: In recent years, we have seen that users edited and shared information actively on various Social Network Sites (SNSs) and those sites are getting richer and more interesting. We expect students can have this mindset similarly on our learning stage. Our study proposed a social networking site for education. Like a stage for students, they can watch and show themselves. We observed altruistic motive and behavior of students on the platform.

There were 30 college students participated. We had found that there were six altruistic behaviors. And Students' altruistic motivations are enjoyment and self-development.

Keywords: altruistic behaviors, social network sites, networking learning, learning stage

1. Introduction

The rise of SNSs (e.g., Wikipedia, Facebook, YouTube), shortening the distance between people. We can keep in touch with friends more directly through SNSs. It is getting to be a new social way for people. SNSs are defined as web-based services that allow individuals to (1) construct a public or semi-public profile within a bounded system, (2) articulate a list of other users with whom they share a connection, and (3) view and traverse their list of connections and those made by others within the system. (Ellison, N. B., 2007) Most of SNSs provide a function to allow users to communicate with each other, multimedia sharing, set personal profiles and even to make a friend with strangers. Moreover, it also has many applications on SNSs such as marketing, games and education. Those developments not only changed our way of life but also provided us a more convenient one. On these SNSs we can observe how user edit and share information actively. We proposed an educational SNS like a stage for students, and they can show themselves. Teachers can interact with students on our platform. Students can watch and learn other's achievement and give feedback for each other. We observed students' altruistic behaviors in this SNS on our study.

The origin of altruistic behavior is difficult to be traced. In different areas have different definitions, such as psychology, sociobiology and economics. There were lots of research in various areas. They had a formal definition of altruistic behavior that is carried out to benefit another from external sources without anticipation of rewards (Rushton, J. P., 1982). Students will do better and more detail assignments because of altruistic motivation, and benefit other students at the same time. That is one of altruistic behaviors on education. Even if other students did not get essentially help, that student who helped other still can learn thoroughly. Compared with consequence, we are more concerned about their altruistic motives. How to improve the learning motivation is an enduring issue. We expected taking the effect on social networking platform into teaching and trying a new teaching model. Let students can learn actively or pay more attention on learning. Therefore, we discussed the following issue and discuss the advantages, disadvantages and the future work in the end.

- (1) What kinds of altruistic behaviors students have when they learned on our learning stage?
- (2) What kinds of altruistic motives students have when they learned on our learning stage?

2. Related Work

2.1 *The social networking sites*

SNSs are the social tool for connecting our friends, classmates and share information. It changed some parts of our daily routine, and even in the social and politics. (Burke et al., 2009; Koh, Kim, Butler, & Bock, 2007). SNSs such as Myspace, Facebook and YouTube, not only have had great influence on millions of users but also have attracted many people to do research. Why did people love to use those SNSs? Nadkarni, A., & Hofmann, S. G. (2012) had concluded two reasons. Those were (1) the need to belong and (2) the need for self-presentation (Nadkarni, A., & Hofmann, S. G., 2012), and another paper mentioned that people who were higher in narcissism and lower in self-esteem were more interesting in SNSs. (Mehdizadeh, S., 2010) In addition, more and more applications were developed on the SNSs in education gradually. One study pointed out that SNSs could be easy to prepare course materials, teach, implement cross-platform device and discuss with others conveniently. (Shiu, H., Fong, J., & Lam, J., 2010) Another research showed that college students believed that the SNSs were helpful in learning English in their experiment. (Kabilan, M. K., Ahmad, N., & Abidin, M. J. Z., 2010). Social networks had more non-school time for extracurricular educational activities because it's highly informal learning environment. And that would enable users to cooperate with each other, involve actively, share resources and learn unintentionally. (Wang, C.-h., & Chen, C.-p, 2013)

As for why a user would share information and data on the Internet actively, That was an great issue and there were numerous studies (Ames & Naaman, 2007; Arakji, Benbunan-Fich, & Koufaris, in press; Cheshire & Antin, 2008; Kim & Han, 2009; Kuo & Young, 2008; Schroer & Hertel, 2009). One study indicated why users edited information on Wikipedia actively. That pointed out it was determined by the balance between costs and benefits, by the identification with the Wikipedia community, and by perceived task characteristics (Schroer, J., & Hertel, G., 2009). Another study indicated why users would share photos on social networks. There were four motives. Those were enjoyment, commitment to the community, self-development and reputation building. And we discussed what factors are associated with the sharing of information goods and participation in social structures of online communities? In addition, the extrinsic motive showed that when people got more than they paid, they might have contributed context. (Lerner & Tirole, 2002) And the intrinsic motive pointed out that people who felt enjoy would be more important than the result. (Torvalds & Diamond, 2001)

2.2 *The altruism*

People take the difficulties on themselves and make things easy for others. That is an example of altruistic behaviors. J. Philippe Rushton pointed out that one formal definition of altruistic behavior is carried out to benefit another without anticipation of rewards from external sources. In Zhang Huiping and Li Hong's (2006) study (Zhang Huiping, 2006), that analyzed the strength of people's performance of altruistic behavior and people were from different backgrounds. They classified motivation of altruism into two kinds. One is benefit another without anticipation of rewards and another one is with anticipation of rewards. They found that there was no significant difference in the comparison of boys and girls male and female. However, there was significant difference in the comparison of whether an only child or not and students from urban or rural areas. In addition, Klisanin (2011) reviewed fifty-four pages and conclude into different forms of altruism, and Klisanin (2011) considered that internet is indeed giving rise to new form of altruism. (Klisanin, D., 2011) In this study we want to show the altruistic behavior of students' on our social networking platform. Whether students would be happier to help others in the areas of their expertise on our learning stage? They would be willing to spend some time search information for others.

3. System Design and Implementation

3.1 *Learning stage*

Our study proposed a learning stage which teachers could interact with students. For teachers, they can teach and prepare materials on the platform. For students, they can learn from the others and get opportunities for self-reflection by watching other's achievements on the platform. Students are difficult to watch and learn from others' achievements on the traditional paper for learning. Our platform makes it easier for students because it can be presented by multimedia. Such as videos, pictures and so on. Greatly increase opportunities for students to watch and learn from each other. In addition, the system as the media for teachers and the status of learning, all the learning outcomes are

presented through a timeline. It will be easy to review in the future if we need. Teachers can also make the report card by the result of students' interaction through the system easily.

There are four main modules provided by our system.

- First, the Mission module:
Teachers can set exam paper and teaching material by using the function, and also decide whether the rights access for specified users to watch content inside, set exam paper questions and so on. Mission environment is showed in Figure 1. For students, they can answer the exam paper on the system.
- Second, the Achievement module:
When students complete a task, the learning stage will produce an achievement. The achievement is the content which students had made, or had learned. Students can review the content and watch the content which shared by others easily in the future if they need. They can also give comments and review to each other. For teachers, in this part, they can see all the learning achievement produced by students and manage students' learning situation. Students' interaction is showed in Figure 2.
- Third, the Collection module:
Students can collect other students' achievements if they are interested in those, or impressed on those. With this, they can review easily in the future if they need.
- Fourth, the Announcement module:
Teachers can announce news to students through the announcement function. Students can also leave messages for the information exchanging, and it will promote interactions between teachers and students.



Figure 1. Mission Environment.



Figure 2. Students' Interaction.

3.2 System Design

Our community platform is presented on the web so that it can be executed on a variety of platforms. With that, teachers, students, and even parents can use our platform without any geographical environment hindrance. They can learn on desktop computer, or in the classroom through connecting our system easily. Our web page is written in PHP. It can playback videos, audios, pictures and other multimedia files. On the implementation mainly divided into two parts, one is make out questions and answer the question, the other part is presentation and management. And then combine the two parts and back-end database into a complete system. We provide a wide measure of a classroom with educational content based on existing production through the above hardware and software architecture. So that students can present the learning outcomes in a different way compared with traditional ways through recording and typewriting. And make students' learning more diversity through peer observation and recommend mechanisms.

4. Experiments and result

4.1 Hypothesis

As we mentioned previously, we expected that students would be able to have behaviors and mentalities just like they were on SNSs. And we expected that those were in accordance with motives we mentioned previously. We also compared relationship between helping attitudes in daily life and altruistic behavior on our learning stage. We wanted to know whether some people are very indifferent, but they show lots of altruistic behaviors on Internet. Therefore, we assumed that:

- In education, students will show lots of altruistic behaviors on our learning stage.
- In education, students' altruistic motives will include Enjoyment, Commitment, Self-development and Reputation on our learning stage.

4.2 Procedure

We conducted an experiment at the university in Taiwan and participants were 30 college students. Students were divided into 8 groups and each group had four students. Two of the groups are only three students. Students' images would be projected onto a computer screen so that they could engage in a dialogue with the virtual character. Students performed in front of KINECT for learning English. Their Achievement will be watched and they can give comments for each other on our networking platform. The design of activities let students show themselves as possible. They will interact with virtual characters for learning English in different contexts. After that they integrate a series of continuous scripts and it will become a film. Then, they can watch other's achievements, give comments and leave a message for each other. In the end, they fill out the questionnaire and chose several students for interviews.

4.3 Questionnaire

4.3.1 The Helping Attitudes Scale

We reference questionnaires (Nickell, 1998). A 20-item measure of participants, helping, feelings, and behaviors. Each item is answered on a 5-point Likert scale, ranging from 1 (strongly disagree) to 5 (strongly agree). For example: It feels wonderful to assist others in need \ Doing volunteer work makes me feel happy

4.3.2 Altruistic Behavior Questionnaire

It is used to view what students' altruistic behavior on our learning stage. We designed questionnaire and the internal consistency reliability coefficients α is 0.842. And we measured the validity by factor analysis, the total explanation of variance have 63.5%. We have 30 samples. We can see in table1. There are total nine questions and the questionnaire is 5-point Likert scale, ranging from 1 (strongly disagree) to 5 (strongly agree).

4.3.3 Altruistic motives

In our study, to view the motivation, we followed the research model by Oded Nov et al (2009). The research model and questionnaires are used for analysis of participation in an Online Photo-Sharing Community. There are total 12 questions and they are divided into intrinsic motivations "Enjoyment" and "Commitment" and extrinsic motivations "Self-development" and "Reputation". We can see that in the table2.

- **Enjoyment:** In this paper, we view whether students show more altruistic behaviors because they feel fun and interesting. For example, I will feel happy when I find that my videos are seen by others on our learning stage.
- **Commitment:** We view whether students want to help others because of the commitment. For example, I will feel down if I can't use on the community platform.
- **Self-development:** We view whether students can learn something from others, make their technical skills better and would be willing to help others actively. For example, I think I can enhance some skills by uploading videos on the community platform.
- **Reputation:** We view whether students do better because they want to get higher reputation. For example, I think I get some reputations by uploading videos to be seen by others on the community platform.

Table 1: Students' altruistic behaviors on our platform.

Question		Mean	SD
1	I will film the video richer because I know it will be seen by the others on the learning stage	3.59	0.78
2	I will be happier to help the others on the learning stage if it is my expertise areas.	4.07	0.53
3	I will take the initiative to review the others' films and give feedback to the others.	3.41	0.73
4	I will film the video more special because I want to get more attentions from the others.	3.34	0.93
5	I would like to film the video again when I watch the others' videos.	3.07	0.99
6	I will pay more attention to perform because I know the video is public.	3.72	0.79
7	I will be happy to spend some time to prepare information and let the others learn and save time.	3.72	0.79
8	I will film the video better because I want to get a higher rating.	3.66	0.97
9	I will not try to let the video show error message because I know the others can see my video on the learning stage.	4.21	0.56
Total Average		3.64	0.53

Table 2: Students' altruistic motives on out platform.

Motives	Mean	SD
Enjoyment	3.70	0.66
Commitment	3.06	0.62
Self-Development	3.76	0.44
Reputation	3.01	0.90

5. Discussion

According to table 1, we can see that there are 6 mean values > 3.5 in the nine altruistic behaviors' questions. We take those as a positive result. And we can see that there are 3 mean values which are amount between 3 and 3.5. We take it as a non-significant result. The data show that students will try to avoid error messages when they make a film, or they will concentrate more on making a film and provide a richer message due to the film they made will be seen by others. However, we have non-significant results. Such as "It will make me re-film again if I see others' videos" and "I will take the initiative to score others' films and give feedback to others". By the interview, we know that the film's content are drab and it had nothing related with what they learned in school, so they didn't want to do it again.

In table 2, we can see the enjoyment and Self-development is a positive result. However, we can see the Commitment and reputation is non-significant results. According to interviews, students believe that they won't have chance to use our learning stage after this experiment, unlike other famous SNSs they use every day. (e.g., Facebook and YouTube). We believe that we can observe more positive result on our learning stage in the long-term observation. According to the interviews with students, they think if our learning stage have more users, they are more willing to use it. The activity design is that let students show themselves as possible so that they will get the others' attentions. Compared to traditional teaching material, multimedia our platform can show richer and unique contents. Students

will be immersed in it. Overall, Most of them believed that they would do better and learn something on our learning stage.

6. Conclusion and Future Work

We put that the initiative of users share and edit information actively on SNSs to the education. We observed altruistic motive and behavior of students on our learning stage. We carried out an experiment in April 2014. Result showed that there were six positive results in our 9 altruistic behaviors' questions. Students will pay more attention to their performances because they care how other students think. They will be happy to spend time to prepare information for others. Simultaneously, most of them believed that they have learned something in the process. Students' altruistic motivations, enjoyment and self-development also have a positive result. In the future, we will do more research and do a long-term and more people experiments. And try to realize how students' altruistic behaviors can help others effectively, find the suitable way for education in the school and design more reliability and validity questionnaires. We look forward to it can have more contribution in education.

Acknowledgements

Thanks teachers and students at Chien Hsin University Department of Hospitality Management in Taoyuan country for their support. This work is supported by the Ministry of Science and Technology, Taiwan, under the grant number MOST 103-2511-S-008-001-MY3.

References

- Ellison, N. B. (2007). Social network sites: Definition, history, and scholarship. *Journal of Computer-Mediated Communication*, 13(1), 210-230.
- Rushton, J. P. (1982). Altruism and society: A social learning perspective. *Ethics*, 425-446.
- Nadkarni, A., & Hofmann, S. G. (2012). Why do people use Facebook? *Personality and Individual Differences*, 52(3), 243-249.
- Mehdizadeh, S. (2010). Self-presentation 2.0: Narcissism and self-esteem on Facebook. *Cyberpsychology, Behavior, and Social Networking*, 13(4), 357-364.
- Shiu, H., Fong, J., & Lam, J. (2010). Facebook-Education with social networking websites for teaching and learning Hybrid Learning (pp. 59-70): Springer.
- Kabilan, M. K., Ahmad, N., & Abidin, M. J. Z. (2010). Facebook: An online environment for learning of English in institutions of higher education? *The Internet and Higher Education*, 13(4), 179-187.
- Wang, C.-h., & Chen, C.-p (2013). EFFECTS OF FACEBOOK TUTORING ON LEARNING ENGLISH AS A SECOND LANGUAGE.
- Schroer, J., & Hertel, G. (2009). Voluntary engagement in an open web-based encyclopedia: Wikipedians and why they do it. *Media Psychology*, 12(1), 96-120.
- Zhang Huiping, L. H. (2006). Investigation on Altruistic Motivation of College Students. *Studies of Psychology and Behavior*, 4(4), 285-289.
- Klisanin, D. (2011). Is the Internet Giving Rise to New Forms of Altruism? *Media Psychology Review*, 3(1).
- Nickell, G. S. (1998). The helping attitude scale. Paper presented at the meeting of the American Psychological Association, San Francisco.
- Oded Nov et al (2009). Analysis of participation in an online photo-sharing community: A multidimensional perspective.

Analyzing Course Competencies: What can Competencies Reveal about the Curriculum?

Swapna GOTTIPATI, Venky SHANKARARAMAN

School of Information Systems, Singapore Management University

swapnag@smu.edu.sg, venks@smu.edu.sg

Abstract: The application of learning outcomes and competency frameworks have brought better clarity to engineering programs. Several frameworks have been proposed to integrate outcomes and competencies into course design, delivery and assessment. However, in many cases, competencies are course-specific and their overall impact on the curriculum is unknown. Such impact analysis is important for analyzing and improving the curriculum design. Unfortunately, manual analysis is a painstaking process due to large amounts of competencies across the curriculum. In this paper, we propose an automated method to discover their impact on the overall curriculum design. We provide a principled methodology for discovering the impact of courses' competencies using Bloom's Taxonomy and the learning outcomes framework.

Keywords: Competencies, Bloom's taxonomy, curriculum analysis, exploratory data analysis, competency cube, undergraduate information systems program

1. Introduction

Learning outcomes and competencies are employed in numerous education programs for achieving transparency and clarity in course design and delivery (Baumgartner & Shankararaman, 2013). Learning outcomes and competencies are not only beneficial to the teaching professionals for structuring the courses, but also for students to track their skills development.

Curriculum analysis unpacks the components of a curriculum to assess and improve it. The curriculum level analysis of competencies has been studied by (Brabrand & Dahl, 2009; Gnana Singh & Leavline, 2013). Nevertheless, there was no principled approach or framework defined for depth analysis at the overall curriculum level. Several researchers have proposed also frameworks or methods to apply learning outcomes and competencies for evaluating the students (Scott, 2003; Lister & Leaney, 2003), and course design and delivery (Hartel & Foegeding, 2004; Baumgartner & Shankararaman, 2013; Ducrot, et al., 2008; EU, 2014). However, the major drawback of these studies is that, they mainly focus at the course level and in many cases the impact on the overall curriculum level is unknown.

Analysing competencies at curriculum level has several advantages. Firstly, it aids in understanding the overall design of the curriculum in terms of skills progression. Secondly, it helps in discovering any discrepancies, blind spots or gaps in the program, and provides pointers for improving the curriculum. Thirdly, it helps in recommending the competencies for a new course.

Manual analysis of course competencies in a curriculum can be a tedious and painstaking effort due to three main challenges. Firstly, even in a small curriculum, the total number of competencies can reach few hundreds. Secondly, the competencies are verbose in nature and often multiple competencies are combined into a single statement. Thirdly, competencies tend to evolve, especially in technology curriculum where changes happen every two to three years.

In this paper, we propose a framework based on cube models (Khairuddin & Khairuddin, 2008), Bloom's taxonomy (Bloom, et al., 1956), Dreyfus' model of skill development (Dreyfus & Dreyfus 1986) and exploratory data analysis (EDA) (Cook & Swayne, 2007) to discover the impacts of courses' competencies on the curriculum. We evaluated our framework on an undergraduate core curriculum; Bachelor of Science (Information Systems Management) degree program BSc (ISM), offered by the School of Information Systems (SIS), Singapore Management University (SMU). Our results show that the curriculum is designed on both cognitive and progression functionalities.

Additionally, we observe some discrepancies in the curriculum design and propose suggestions for improvements.

The rest of the paper is organized as follows. In Section 2, we study some related work. We give some background Section 3 and Section 4 presents our solution framework. In Section 5, we describe our dataset, present our evaluation results, discussions and we conclude in Section 6.

2. Literature Review

Learning outcomes are statements of a learning achievement and are expressed in terms of what the learner is expected to know, understand and be able to do on completion of the program (Kennedy, et al., 2009). A competency is expressed for individual courses within the curriculum, using a vocabulary of learning outcomes (Kennedy, et al., 2009). For the quality of higher education, learning outcomes are becoming accountable and quality assurance frameworks (Wheeler, 2007). The Qualification Frameworks (EU, 2014) are based on learning outcomes and competencies. In (Ducrot, et al., 2008) paper, the learning outcomes are at the program level and the sub skills (competencies) are specified under them. However, (Hartel & Foegeding, 2004) defined competencies at a higher level than the learning outcomes. In this paper, we use the framework defined by (Ducrot, et al., 2008).

Several learning taxonomies have been recognized as important paradigms in planning and developing educational, training, and professional development curricula (Bloom, et al., 1956; Krathwohl, 2002; O’Neill & Murphy, 2010). Bloom proposed a simpler taxonomy for the cognitive domain, while Biggs’ SOLO taxonomy (O’Neill & Murphy, 2010) is more complex and detailed framework. Additionally, to understand the progress of skills learned, Dreyfus proposed a framework, skill development model (Dreyfus & Dreyfus, 1986), which overlaps with Bloom’s cognitive domain.

Bloom’s taxonomy has been applied in various aspects of learning and education. Examples include, computer science assessments (Scott, 2003), assessing the students based on their ability (Lister & Leaney, 2003), effective course design (Whetten, 2007), curriculum improvement problem (Wheeler, 2007) and generating customized tests (Raykova, et al., 2011). For our solution, we used Bloom’s taxonomy to analyse the curriculum on the cognitive functionality and Dreyfus’ model of skill development for progression functionality.

3. Background

3.1 Learning Outcomes Framework

Several frameworks have been proposed to integrate the learning outcomes in to the education (Hartel & Foegeding, 2004; Ducrot et al., 2008). In Figure 1 (a), we show the Learning Outcomes Framework implemented (LOF) at the School of Information Systems, Singapore Management University.

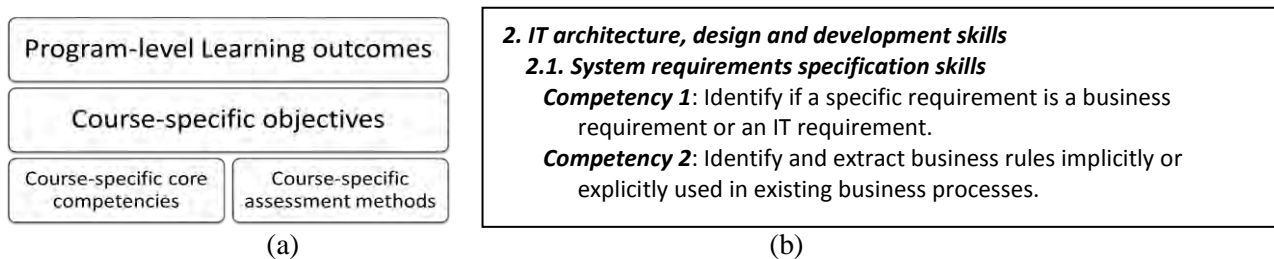

Figure 1. (a) Learning Outcomes Framework. (b) Sample competencies from Y2 course.

LOF consists of three major components: learning outcomes, competencies and assessments. While the learning outcomes have been established at the program level, competencies and assessment are defined at the individual course level. Figure 1 (b) shows an excerpt showing the learning outcome 2 with one of the associated 2nd level learning outcomes and the corresponding competencies for a second year course. For complete list, please refer to (Baumgartner & Shankarara man, 2013) and Ducrot et al., 2008. Though assessments play an important role in curriculum analysis, it is not the focus of our study and we leave it for future works.

3.2 Learning Taxonomies

Bloom's taxonomy divides the learning aspects into three domains; cognitive, affective and psychomotor. Cognitive domain focuses on the thinking level and has been widely applied in several domains including software engineering (Khairuddin & Khairuddin, 2008) and engineering (Gnana Singh & Leavline, 2013). It provides variety of action verbs to write the competencies for a course (Krathwohl, 2002).

In addition to having standard method to facilitate course design and assessment on the cognitive scale, understanding the progressive stages for learning and skill development by individual learners is also important. Dreyfus proposed a skill progression model from awareness to mastery (Dreyfus & Dreyfus, 1986). The skill progression model stages from novice to expert. The three main stages play major role in tracking the progress of the learners; awareness, proficiency and mastery (Judith et al. 2008).

4. Method

In this section, we describe our method to discover the impact of competencies on the curriculum.

4.1 Competency Cube

A competency cube is a conceptual integrated model which integrates the essential elements in design or assessment of learning aspects (Khairuddin & Khairuddin, 2008). Recall that our data consists of three components; learning outcomes (subsumes the competencies), cognitive levels, and skill progression levels. We integrated all these three essential components as shown in Figure 4. Each of the learning outcomes, as depicted on the z-axis of the cube, can be classified in relation to the level of cognitive functioning (see Figure 3, y-axis) as well as each learning outcome can be classified to the specific skill progression level (Dreyfus' model of skill development, x-axis).

The competency cube is similar to data model, where the cube can be sliced and diced across the dimensions to summarize the data. Therefore, when the cube is sliced we can classify the outcomes by cognitive levels and when diced, we can classify the outcomes by progression levels. This cube can be now integrated into a process framework for detailed data analysis.

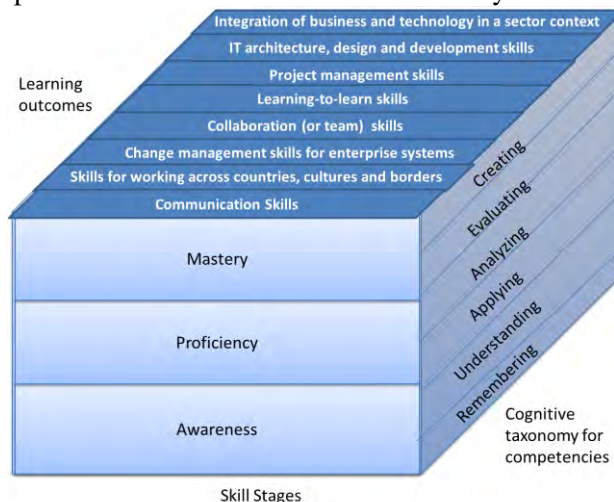

Figure 4. Competency cube – an integrated model of learning outcomes, Bloom's taxonomy and Dreyfus' skill development model

4.2 Automated Curriculum Analysis Framework

We now describe the process framework for curriculum analysis using the competency cube. Figure 5 depicts the sequential process of curriculum analysis framework. Given the full list of competencies expressed by the instructors, in the first stage, the competency cube generates the competencies that are aligned cognitively. To achieve this, Bloom's action verbs (Krathwohl, 2002) are used.

A simple text search is executed on each competency to discover verbs for every cognitive level and the competency is aligned to the corresponding cognitive level. In this process, if multiple verbs are found, the competency is aligned to multiple competencies. For example, “Create and evaluate the business process model for a given real world scenario”, consists of two cognitive functions; *Creating* and *Evaluating*. Therefore, we align the competency to both levels. The competencies will also be categorized and aligned by skills stages - progressively. In the above example, the competency will be aligned to the progression level, “*Mastery*”.

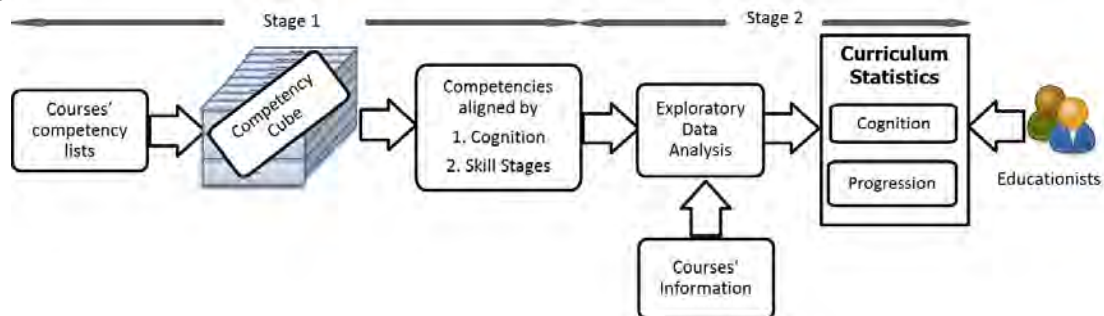

Figure 5. Automated curriculum analysis framework (ACAF)

In the second stage, exploratory data analysis (EDA) (Cook & Swayne, 2007) is executed on the course information (year, term, level, etc.) and on the processed competencies to generate the statistics on the overall curriculum. EDA is useful in summarizing the data using various graphical techniques such as box plots, line graphs, bar graphs, etc. These visuals aid the educationists to analyse the curriculum and make decisions. In summary, cognitive statistics aids in analyzing the curriculum by thinking levels, while skill progression statistics aids in analyzing the curriculum by skill development levels.

5. Experiments

5.1 Dataset

For our experiments we used the undergraduate core curriculum courses from School of Information Systems, Singapore Management University; 14 courses (Year1=4, Year2=6, Year3=4). The course coordinators for each course are required to provide the list of competencies (raw competencies) and map them to program-level learning outcomes. Initially, there were 398 raw competences and after applying the alignment process (Stage 1) discussed in Section 4.2, the total number of aligned competencies increased to 578. All our experiments are based on the processed competencies.

5.2 Cognitive Analysis Results

Recall that applying EDA on competencies which are cognitively aligned yields the curriculum analysis by thinking levels. Figure 6 shows the curriculum cognitive analysis by year.

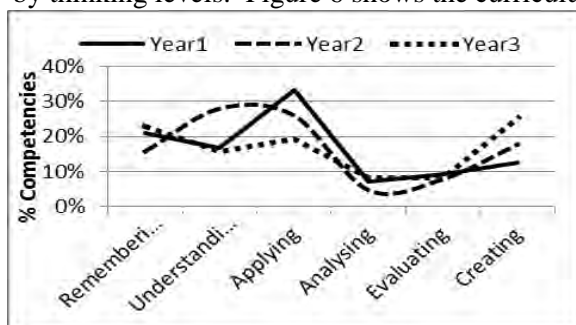

Figure 6. Cognitive: Curriculum analysis by year

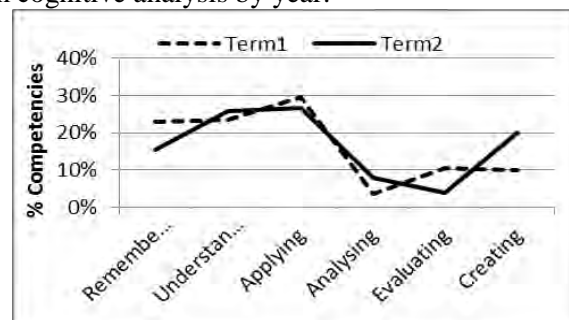

Figure 7. Cognitive: Curriculum analysis by term

We observe that year 1 (Y1) courses majorly focus on remembering and applying. This is because, Y1 courses such as software foundations and data management are technical in nature and are

designed to emphasize learning by application component. Y2 courses majorly focus on understanding and applying. At the same time, they introduce mastery by creating or developing new products. Y3 courses focus on mastery while testing the users' remembering capability. Figure 7 shows the curriculum cognitive analysis by term. We observe that term 1 (T1) courses focus on awareness by remembering and in contrast, term 2 (T2) courses focus on mastery by creating. Both the terms emphasize applying as the curriculum is mainly based on business application of technology.

Next, we evaluate the impact of competencies on curriculum by course level (foundation vs. advanced) as shown in Figure 8. Foundation courses focus on remembering and applying. In contrast, advanced courses focus on mastery by creating. We also observe that advanced courses also emphasize on understanding and applying.

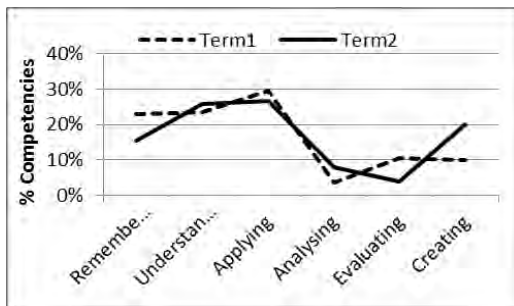

Figure 8. Cognitive: Curriculum analysis by level

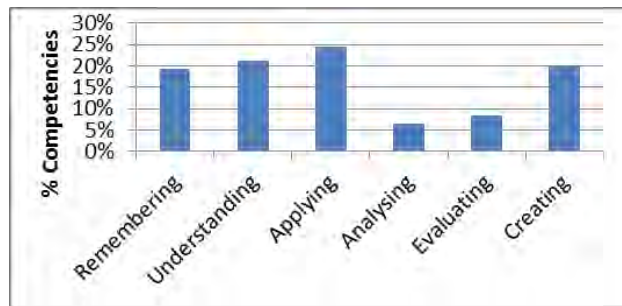

Figure 9. Cognitive: Overall curriculum analysis

Figure 9 shows the average cognitive analysis for curriculum. We observe that, in general the curriculum gives importance to remembering, understanding, applying and creating thinking levels. Evaluating and analyzing components are at a low level, less than 10%. This can be an aspect where the educationist might need to intervene to make decisions on the curriculum design for its improvements.

5.3 Progression Analysis Results

Figure 10 shows the overall curriculum progression analysis. We observed that, proficiency appears to be centered across the curriculum. Mastery appears to be similar to proficiency except for it has lower number of competencies (mean is lower). Awareness has excess variation. Some courses gave major emphasis on awareness while others don't. We observe that, for all years, awareness is given similar importance. However, the focus on proficiency skills decreased from Y1 to Y2. In contrast, focus on mastery skills increased from Y1 to Y2.

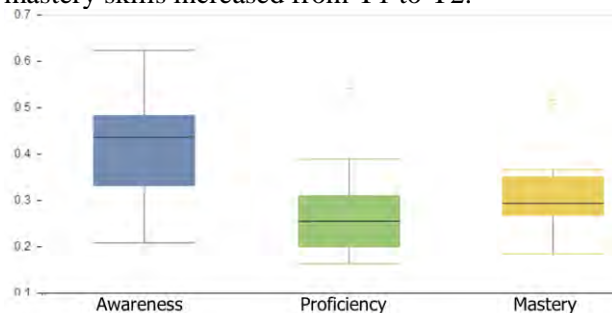

Figure 10. Progression: Overall curriculum analysis

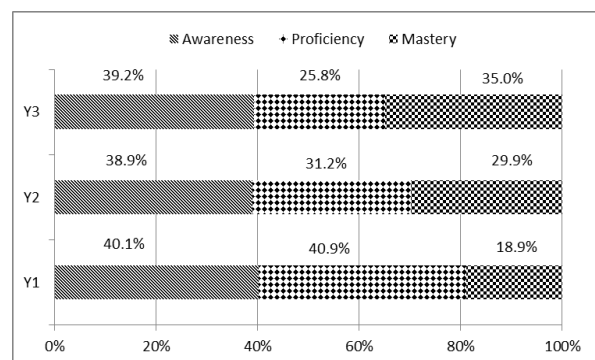

Figure 11: Progression: Curriculum analysis by year

Figure 10 and Figure 11 shows an inconsistent output for awareness. Figure 11 shows that the awareness component is similar for all the years. In contrast, Figure 10 shows that the awareness component has the highest variation.

5.4 Threats to Validity

Curriculum analysis consists of three high level dimensions; design (e.g. course design), impact (e.g. job placements) and policy (e.g. vision). In our paper, we only focused on the design analysis. In

particular we exploited the competencies for the analysis as they are the building blocks for the course design. The results from our experiments on the undergraduate curriculum show the strengths of the curriculum such as balanced cognition levels across the curriculum over the years. At the same time, the experiments identified some of the blind spots in the curriculum such as missing thinking levels for certain courses and low emphasis on evaluation and analyzing across the curriculum. However, the curriculum analysis at the design dimension is incomplete without studying the impact by other course components such as assessments, resources etc., and we leave such analysis for the future studies.

6. Conclusion

Analyzing curriculum is important to not only understand if the current goals are met but also to identify potential problems as early as possible and recommend possible solutions. In this paper, we attempt to analyse an undergraduate core curriculum based on the course competencies. The framework proposed can also be extended to recommendation system where the competencies can be recommended for a new course. In future it is also interesting to study the application of this framework on other curricula. Curriculum analysis is incomplete without analyzing other important components of the curriculum such as course delivery, assessments, resources etc., For example, one can extend the competency cube for assessment analysis and to recommend competencies for new courses.

References

- Baumgartner, I & Shankaraman, V. (2013). Actively linking learning outcomes and competencies to course design and delivery: experiences from an undergraduate Information Systems program in Singapore. *IEEE Global Engineering Education Conference (EDUCON 2013)*, Berlin, Germany.
- Bloom, B.S., Engelhart, M.D., Furst, E.J., Hilland, W.H., & Krathwohl, D.R. (1956). Taxonomy of educational objectives: Handbook I: Cognitive domain, New York: David McKay, vol. 19, pp. 56
- Brabrand, C., & Dahl, B. (2009). Analyzing CS competencies using the SOLO taxonomy. In the *Proceedings of the 14th annual ACM SIGCSE conference on Innovation and technology in computer science education*.
- Cook, D., & Swayne, D.F. (2007). *Interactive and Dynamic Graphics for Data Analysis: With R and GGobi*. Springer.
- Dreyfus, H.L., & Dreyfus, S.E. (1986). *Mind over machine: the power of human intuition and experience in the era of the computer*. Oxford: Basil Blackwell.
- Ducrot, J., Miller, S., & Goodman, P.S. (2008). Learning Outcomes for a Business Information Systems Undergraduate Program. *Communications of the Association for Information Systems: Vol. 23, Article 6*.
- EU. (2014). The European Qualifications Framework. European Union Education and Culture DG.
- Gnana Singh, A.A., & Leavline, E.J. (2013). Competency-Based Calisthenics of Learning Outcomes for Engineering Education. *International Journal of Education and Learning, Vol. 2, No. 1*, pp 25-34.
- Hartel, R.W., & Foegeding, E.A. (2004). Learning: Objectives, Competencies, or Outcomes. *Journal of Food Science Education, (3)* pp. 69-70.
- Judith G. Calhoun, Kalpana Ramiah, Elizabeth McGean Weist, and Stephen M. Shortell. (2008) Development of a Core Competency Model for the Master of Public Health Degree. *American Journal of Public Health*.
- Kennedy, D., Hyland A., & Ryan N. (2009). Learning Outcomes and Competences: Introducing Bologna Objectives and Tools, B 2.3-3, pp. 1-18.
- Khairuddin, N.N., & Khairuddin, H. (2008). Application of Bloom's taxonomy in software engineering assessments. In *Proceedings of the 8th conference on Applied computer science (ACS'08)*.
- Krathwohl, D.R. (2002). A revision of Bloom's Taxonomy: an overview. Benjamin S. Bloom, University of Chicago, *Theory Into Practice*, 42 (4), pp 216.
- Lister, R., & Leaney, J. (2003). Introductory programming, criterion-referencing, and bloom. In *Proceedings of the 34th SIGCSE technical symposium on Computer science education*. ACM, New York, pp. 143-147
- O'Neill, G., & Murphy, F. (2010) Guide to taxonomies of learning. UCD Teaching and Learning/Resources, Available <http://www.ucd.ie/t4cms/ucdtla0034.pdf>.
- Raykova, M., Kostadinova, H., & Totkov, G. (2011). Adaptive test system based on revised Bloom's taxonomy. In *Proceedings of the 12th International Conference on Computer Systems and Technologies*. pp. 504-509.
- Scott, T. (2003). Bloom's taxonomy applied to testing in computer science classes. *J. Comput. Small Coll.* 19, 1, pp 267-274.
- Wheeler, D. (2007). Using a summative assessment alignment model and the Revised Bloom's Taxonomy to improve curriculum development, instruction and evaluation. *Doctoral dissertation*, Syracuse University.
- Whetten, D.A. (2007). Principles of effective course design: What I wish I had known about Learning-Centered Teaching 30 Years Ago. *Journal of Management Education*, 31(3), pp. 339-345, pp. 347-357.

Applying an Extensible Learning Support System to Learning by Problem Posing

Kiyoshi NAKABAYASHI^{a*} & Yosuke MORIMOTO^b

^a*Faculty of Information and Computer Science, Chiba Institute of Technology, JAPAN*

^b*Faculty of Liberal Arts, The Open University of Japan, JAPAN*

* knaka@net.it-chiba.ac.jp

Abstract: This paper describes an investigation in which the Extensible Learning Environment with Courseware Object Architecture (ELECOA) was applied to a learning environment where problems are posed by learners. The aim of ELECOA is to provide a flexible learner-adaptive system that ensures both function extensibility and content reusability. To achieve this goal, the concept of a “courseware object” has been introduced to allow incremental implementation of various educational functionalities. Several learning environments have been based of this concept, including a self-learning environment compliant with the SCORM 2004 specification and a group-learning environment based on the Learning Design specification. This paper reports the results of a prototype implementation of ELECOA in an environment for learning by problem posing that is a mixture of self-learning and group-learning.

Keywords: Learner adaptation, extensible learning support system, courseware object, group learning, problem posing by learner

1. Introduction

Learning by question generation or problem posing is recognized as an effective way to enable learners to achieve a deep understanding of their studies (Brown and Walter, 2005). Recently, various learning environments have been designed and implemented to support problem posing by learners (Hirai, Hazeyama, and Inoue, 2009; Takagi and Teshigawara, 2006; Yu and Wu, 2012; Yamamoto, et al., 2013). These environments can be categorized into two types. In the first type, the system, equipped with certain domain knowledge on the study subject, supports and diagnoses questions generated by a learner (Yamamoto, et al., 2013). In the second type, the system provides a group learning environment in which learners can generate questions, share them with each other, and discuss how to improve them (Hirai, Hazeyama, & Inoue, 2009; Takagi and Teshigawara, 2006).

This study deals with the second type in which questions are generated in a group learning environment. As for the question generation environment, we used the Extensible Learning Environment with Courseware Object Architecture (ELECOA), which is capable of both function extensibility and content reusability (Nakabayashi, Morimoto and Hada, 2010). ELECOA is based on the concept of a “courseware object”. A courseware object is a program module that is used to incrementally implement various educational functionalities. In our previous study, ELECOA was applied to several learning environments (Nakabayashi, Morimoto and Aoki, 2012), including a learner-adaptive self-learning environment compliant with the SCORM 2004 specification (ADL, 2006) and a group-learning environment based on the Learning Design (LD) specification (Koper and Tattersall, 2005; IMS, 2003). In this study, a learning environment for question generation was designed by exploiting existing courseware objects for self-learning and group-learning in combination with newly developed courseware objects for the question generation functionality.

The following section explains ELECOA and the concept of a courseware object. After that, the courseware objects for question generation and their prototype implementation are introduced. Several possible designs of learning environments for question generation and future issues are discussed in the last section.

2. Extensible Learning Environment with Courseware Object Architecture (ELECOA)

To let content designers create educational content to achieve their learning objectives without requiring deep programming knowledge, conventional self-learning systems usually use an architecture in which the content is clearly separated from the platform. The content is an aggregation of learning materials related to a certain learning subject, whereas, the platform is equipped with generic functionalities, such as learner management, learning log recording, and learner adaption, that are common to the various study subjects. The drawback of this architecture is the lack of function extensibility. If content designers or instructional designers want to create content with new educational functionalities, it is quite difficult to extend the platform once it has been implemented. This is because there is no mechanism to assure that the existing learning content for the original platform will work correctly on the extended platform.

ELECOA was proposed as a way to overcome the drawbacks of conventional systems and achieve both function extensibility and system interoperability (Nakabayashi, Morimoto and Hada, 2010). ELECOA is characterized by its modular system architecture shown in Figure 1. It employs the concept of a “courseware object”, a building block that implements various educational functionalities, such as sequencing strategies of learning materials. As shown in Figure 1, the courseware object is clearly separated from the platform, thereby enabling incremental function extension by adding new courseware objects. Since the existing courseware objects and new courseware objects do not interfere with each other, the existing content will work correctly after the function extension.

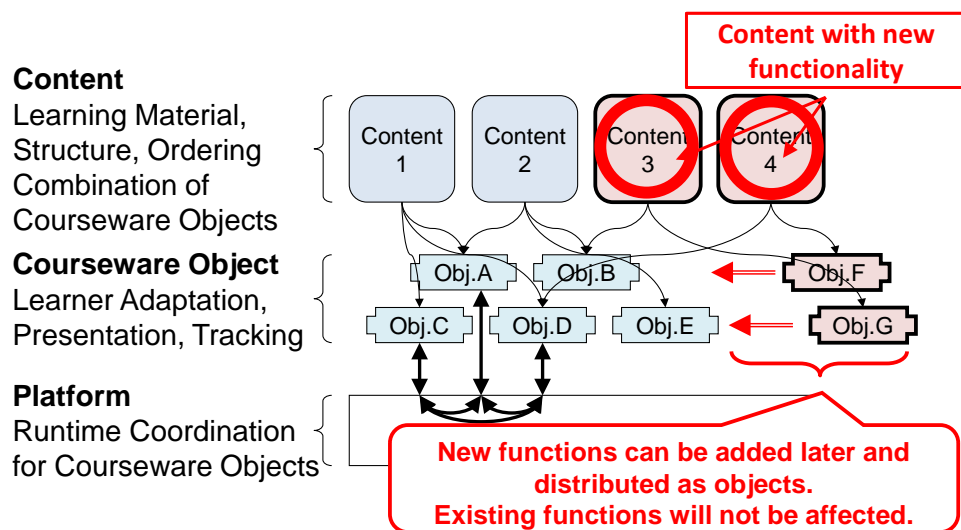

Figure 1. ELECOA framework.

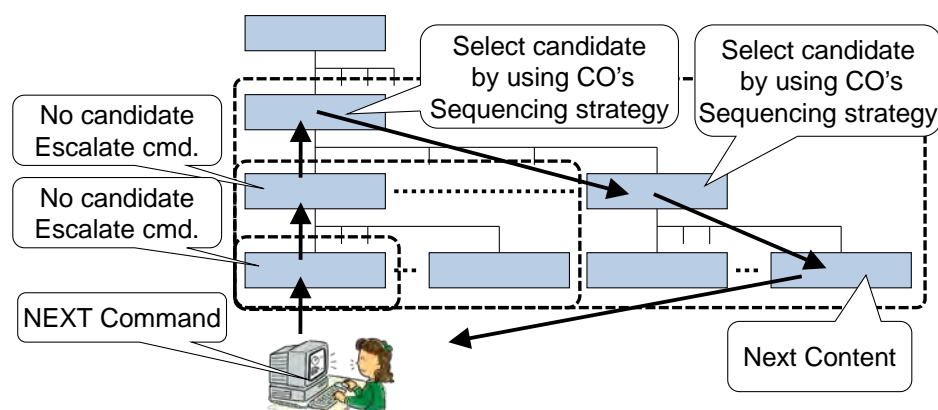

Figure 2. ELECOA for content with a tree structure.

ELECOA has been applied to both self-learning and group-learning environments with tree-like learning-flow control structures (Nakabayashi, Morimoto and Aoki, 2012; Nakabayashi and Morimoto, 2013). In these applications, courseware objects are allocated to the tree nodes, as shown in Figure 2. Each courseware object then manages the sequencing of the sub-tree under its node. According to the sequencing strategy implemented in it, the courseware object is responsible for selecting the most suitable node from among its child nodes. This sort of configuration makes it possible to implement different pedagogical strategies in different sub-trees. To achieve interoperability between courseware objects created by various implementers, the communication between courseware objects is limited to only between parents and children. The basic communication patterns and interface between the courseware objects have been designed within this limitation, and defining these basic communication patterns and the interface maximizes the interoperability of courseware objects. As the example of a self-learning environment, the SCORM 2004 specification, a standard for learner-adaptive content, has been implemented according to this configuration (Nakabayashi, Morimoto and Hada, 2010). The implementation was successfully examined against test cases of the SCORM 2004 3rd edition test suite.

To apply ELECOA to an LD-specification-based group learning environment, we exploited the fact that the LD specification, which is capable of formally describing a group learning sequence, uses a tree format, like the self-learning environment (Nakabayashi, Morimoto and Aoki, 2012; Nakabayashi and Morimoto, 2013). The implementation is shown in Figure 3. A tree-like learning flow control is assigned to each individual learner. The courseware object allocated at each tree node controls the learning sequence of each individual learner by taking into account the learner's status such as learner's level and accomplishments. This is the same manner as the original ELECOA for self-learning. Thus, it is possible to implement a learning path control based on each individual's status as required by the LD specification. In addition, a courseware object can reflect the statuses of multiple learners in order to select each individual learning path. This is possible by designing the courseware object to be able to exchange information with other courseware objects assigned to other learners. This means that each learner's learning path can be controlled by his or her own learning status as well as those of other learners. Regarding communication tools, these are associated with the leaf node of the hierarchical structure as learning resources. This is a requirement of the LD specification, and at the same time, it is consistent with the original ELECOA self-learning environment in which learning resources are assigned to the leaf nodes of the content tree.

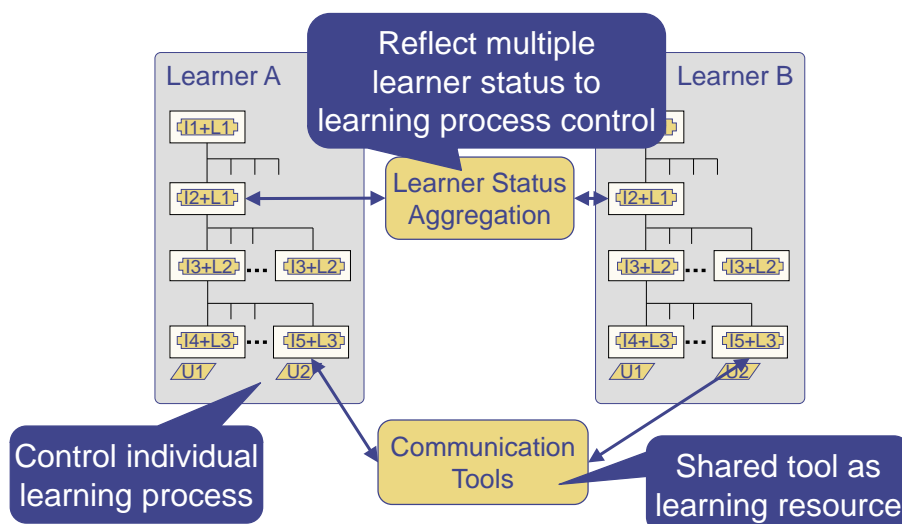

Figure 3. Implementation of group learning environment with ELECOA.

3. Application of ELECOA to Problem Posing

This section discusses an application of ELECOA to a problem-posing environment. The target is an environment in which a group of learners generates questions, then other learners and teachers share,

review, and improve the questions. The generated questions are sometimes utilized as course materials (Hirai, Hazeyama, and Inoue, 2009; Takagi and Teshigawara, 2006). It is not in the scope of this study but rather a potential future work item to implement the function to support or diagnose the problem-posing activities by using domain knowledge about the specific subject. Rather, this study proposes a generic group learning framework for problem-posing environments based on ELECOA courseware objects that were designed in accordance with common basic function requirements extracted from existing problem-posing environments which were implemented ad-hoc.

Problem-posing group learning environments require three basic functions:

- (1) Control of discussions associated with problems,
- (2) Generation and modification of questions as well as generation of associated discussions, and
- (3) Utilization of questions as materials

The first requirement is common to the group learning environment described in the previous section. In the problem-posing environment, however, the role of the learner who creates the problems may be different from other learners and teachers. There can be a pre-defined sequence of discussions that is used to control the discussions associated with each generated problem. The second requirement is specific to problem-posing group learning environments. The original ELECOA architecture assumes that the learning control tree and associated learning resources are defined before the start of learning. Problem-posing group learning environments require a capability that lets learners generate questions dynamically while they are learning and to share and modify these questions based on discussion. The third requirement is that the generated questions should be able to be dynamically utilized as conventional self-learning materials.

Figure 4 depicts the ELECOA-based problem-posing group learning environments designed according to the above requirements. The “Problem list” courseware object has “problem” courseware objects as its child nodes. Each problem courseware object has a “problem content” learning resource and “discussion” courseware object as its children. The “Discussion” courseware object has “discussion content” learning resource. This tree structure is assigned to every learner participating in the group learning.

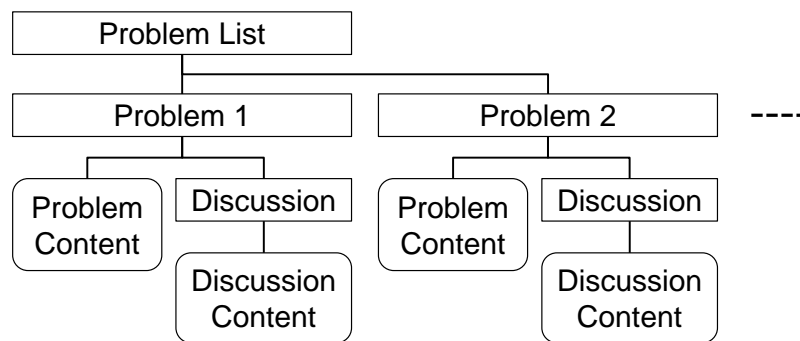

Figure 4. Implementation of problem posing group learning environments with ELECOA.

The problem list courseware object accepts and executes commands from learners, including “create new problem”, “list problems” and “select problem”. In particular, the “create new problem” command generates a new problem courseware object as the child of the problem list courseware object. The problem courseware object executes commands such as “edit problem content”, “view problem content” and “submit problem”. The discussion courseware object executes commands such as “submit comment” and “view comment”.

The problem courseware object and discussion courseware object manage the state transition table to control the problem-posing learning scenario. For example, a certain problem-posing learning strategy may require the following learning process:

- (1) A learner creates a new problem,
- (2) Other learners answer the problem,
- (3) Other learners evaluate and give comments on the problem,
- (4) The learner who created the problem modifies the problem,
- (5) The learner may ask for comments from the teacher before he/she modifies the problem,
- (6) These steps are repeated until there are no comments to be reflected.

In this learning scenario, the learner who created the problem must modify question by him-/herself. There can be other learning scenarios in which every learner has an opportunity to give comments and modify the problem at any time. It is possible to implement an appropriate state transition table to be managed by each courseware object according the chosen learning scenario.

Figure 5 shows screenshots of the prototype implementation. The left area of each window is the tree control structure corresponding to the one shown in Figure 4. From this area, the learners can take commands to create new problems, modify problems, and participate in discussions. The prototype was developed as a Moodle plugin so that the Moodle learner group assignment is inherited by the developed environment.

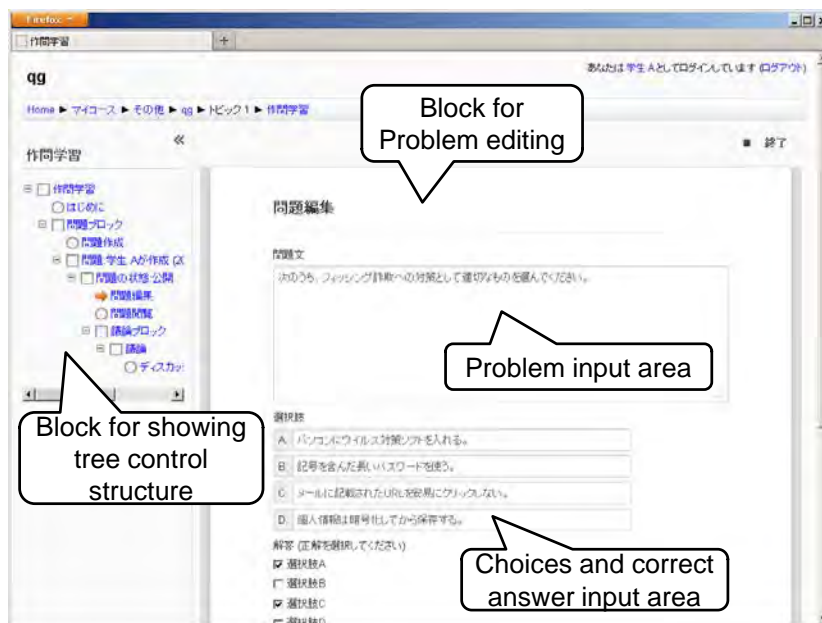

a) Problem editing window



b) Comment editing window

Figure 5. Screenshots of prototype implementation.

4. Conclusion

This paper described an investigation and prototype application of ELECOA to a learning environment for problem posing by learners. The aim is to provide a generic system framework for problem-posing environments. Several courseware objects were developed according to the requirements and a prototype system was implemented. In the future, we will deploy this system in an actual classroom environment and assess how it works. It will also be necessary to improve the communication protocol between newly developed courseware objects so that they are consistent with the existing self-learning courseware objects to develop an unified learning environment capable of integrating self-learning and group learning.

Acknowledgements

This work was supported by Grants-in-Aid for Scientific Research by the Japan Society for the Promotion of Science (Kakenhi 26280128 and 26242013).

References

- Advanced Distributed Learning (2006). *Shareable Content Object Reference Model SCORM® 2004* (3rd ed.)
- Brown, S.I., & Walter, M.I. (2005). *The art of problem posing* (3rd ed.). New Jersey: Lawrence Erlbaum Associates.
- Hirai, Y., Hazezama, A., & Inoue, T. (2009). Assessment of Learning in Concerto III: A Collaborative Learning Support System Based on Question-posing, In *Proceedings of CATE2009* (pp. 36-43). Calgary, Canada: ACTA Press.
- IMS Global Learning Consortium (2003), *IMS Learning Design Version 1.0 Final Specification*.
- Koper, R. & Tattersall, C. (2005), *Learning Design: A Handbook on Modelling and Delivering Networked Education and Training*, Springer.
- Nakabayashi, K., Morimoto, Y., & Hada, Y. (2010). Design and Implementation of an Extensible Learner-Adaptive Environment, *Knowledge Management & E-Learning: An International Journal (KM&EL)*, 2(3), 246-259.
- Nakabayashi, K., Morimoto, Y., & Aoki, K. (2012). Application of Extensible Learning Support System Architecture to Collaborative Learning Environments, In *Proceedings of the 12th IEEE International Conference on Advanced Learning Technology* (pp. 69-73), Rome, Italy: IEEE Computer Society.
- Nakabayashi, K. & Morimoto, Y. (2013). Investigation on Function Extension of Extensible Learning Support System Architecture to Group Learning Environment, In *Proceedings of the IEEE International Conference on Teaching, Assessment and Learning for Engineering* (pp. 335-339), Bali, Indonesia: IEEE Computer Society.
- Takagi, M., & Teshigawara, Y. (2006). A WBT System Enabling to Create New or Similar Quizzes Collaboratively by Students. In *Proceedings of ICET2006* (pp. 263-268). Calgary, Canada: ACTA Press.
- Yamamoto, S., Hashimoto, T., Kanbe, T., Yoshida, Y., Maeda, K., & Hirashima, T. (2013) Interactive Environment for Learning by Problem-Posing of Arithmetic Word Problems Solved by One-step Multiplication. In *Proceedings of the 21st International Conference on Computers in Education ICCE 2013* (pp. 51-60). Bali, Indonesia: Uhamka Press.
- Yu F.-Y. & Wu C.-P. (2012) Student Question-Generation: The Learning Processes Involved and Their Relationships with Students' Perceived Value. *J. Research in Education Science*, 57(4), 135-162.

AR based Skill Learning Support System with Velocity Adjustment of Virtual Instructor Movement

Takuya MISHIMA^{a*}, Masaru OKAMOTO^a & Yukihiro MATSUBARA^a

^aGraduate School of Information Sciences, Hiroshima City University, Japan

*lmishima@lake.info.hiroshima-cu.ac.jp

Abstract: In this paper, we propose the skill learning support system to give learner the real time feedback information. In this system, to construct feedback, the virtual room based on recorded user's image is used. In virtual room, instructors bone model is displayed too. In learning process, learner imitates displayed bone model to get the knowledge about skill corresponding to instructor's movement. By displaying virtual instructor and learner's body in the virtual room, learner can see virtual instructor's movement and learner's posture. Additionally, virtual instructor's speed can be adjusted by learner's intention. To control virtual instructor's speed, learner's voice is used as input information. To get user's voice and record image, Microsoft Kinect sensor is used as a camera and a microphone in the developed prototype system. To evaluate this approach, the prototype system for learning skill of soft tennis (swing form) was developed. So, evaluations experiments were conducted by using the prototype system of soft tennis and effectiveness of adjustment of virtual instructor's speed in learning process was shown.

Keywords: Skill Learning, Augmented Reality, Velocity Adjustment, Soft Tennis

1. Introduction

Recently, in support of skill learning techniques, measurement devices have often been used to record learner movements. Many studies have developed supportive learnings to enhance the skill learning techniques. Gotoda conducted research on a training support method using measurement technologies (Gotoda, Matsuura, Nakagawa, Miyaji, 2013); this method provided the learners with a real-time system for learning the shot timing in tennis. The system predicted the trajectory of the ball by measuring the position of the ball from the moving image and by analysing the change in position of each frame. By using the system, a learner can easily learn appropriate shot-timing. However, motion capture in support of skill learning techniques remains very expensive. One example of a motion-capture device is the Microsoft Kinect sensor. Kinect can measure joints without markers, and therefore, Kinect is widely used to develop learning support system (Hamagami, Matsuura, Kanenishi, Gotoda, 2012; Tamura, Uehara, Maruyama, Shima, 2013; Chuang, Kuo, Lee, Tseng, Hsu, 2013) and rehabilitation system (Meng, Fallavollita, Blum, Eck, Sandor, Weidert, Waschke, Navab, 2013) and learning support system (Akawaza, Takei, Nakayama, Suzuki, 2013; Anlauff, Cooperstock, Fung, 2013; Iwane, 2012; Mitsuhara, 2012; Shih, Wu, Chen, 2013; Thakkar, Shah, Thakkar, Joshi, Mendjoge, 2012). In particular, Ochi et al. (2013) proposed the air squat training support system using the Kinect to measure user movements. By using the Kinect, the system obtains skeletal information from the side suitable for an air squat. The system can create feedback from the skeletal information for the learner. Yamaoka et al. (2012) proposed a system for the flying disc throw; the proposed system captures a learner's arm movements, checks their height, and displays feedback messages to adjust their actions.

On the other hand, in our research group, we proposed a skill learning support method, in which the learner imitates a display showing arm movements (Sumimoto et al., 2013). Our method presents the orbit of the bending and stretching motions of the arm to the learner. In this paper, through experimental results, we show our method for skill learning in slow motion. Thereby, we prove that the presentation velocity affects learning. Therefore, in this study, we propose a skill learning support method that considers velocity adjustments of the virtual instructor. By adjusting the velocity of the virtual instructor, our system teaches at a suitable rate based on the time of learning. While learning, a learner can adjust the virtual instructor's speed in order to successfully imitate the instructor's

movements. As feedback, the virtual instructor is displayed using AR-technology (Augmented Reality-technology). In this paper, we describe the prototype learning support system for soft tennis, and detail our experiments using this prototype system.

2. The AR Based System for Skill Learning Support System

2.1 System Summary

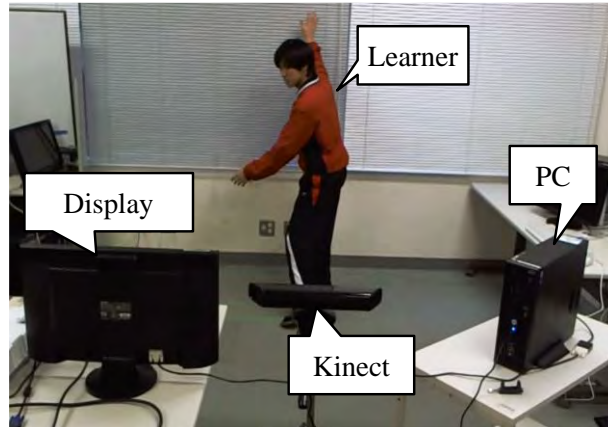

Figure 1. Overview of the Proposed System.

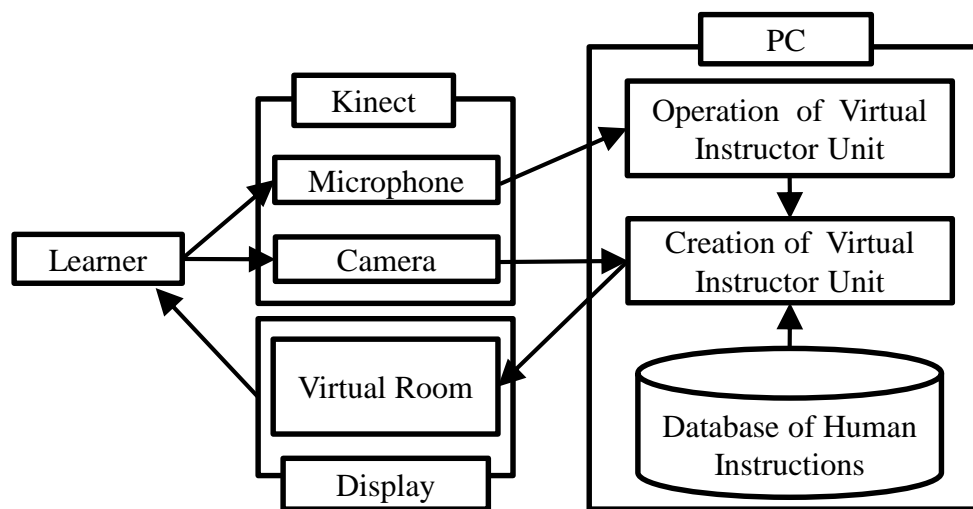

Figure 2. Framework of Proposed System.

Figure 1 shows the overview of the proposed system. The system consists of the display, Kinect and PC. Figure 2 shows the framework of the proposed system. The system has two units: the operation of virtual instructor unit and the creation of virtual instructor unit. The operation of virtual instructor unit adjusts the velocity of the virtual instructor via instructions from the microphone. Feedback is sent on the display. Figure 3 shows the feedback. The system develops the feedback by adding the virtual instructor to the image captured by the Kinect. The virtual instructor is displayed as a skeleton, and makes some soft tennis swing motions.

2.2 Virtual Room and Velocity Adjustment of Virtual Instructor

Figure 4 shows the virtual room presented on the display. Figure 4 (a) is the display of the virtual instructor in the virtual room. The virtual instructor presents the movement instructions. Figure 4 (b) is an example of the virtual room during learning. The learner learns soft tennis skills by imitating the movement of the virtual instructor. The virtual instructor's current speed is displayed in the left corner

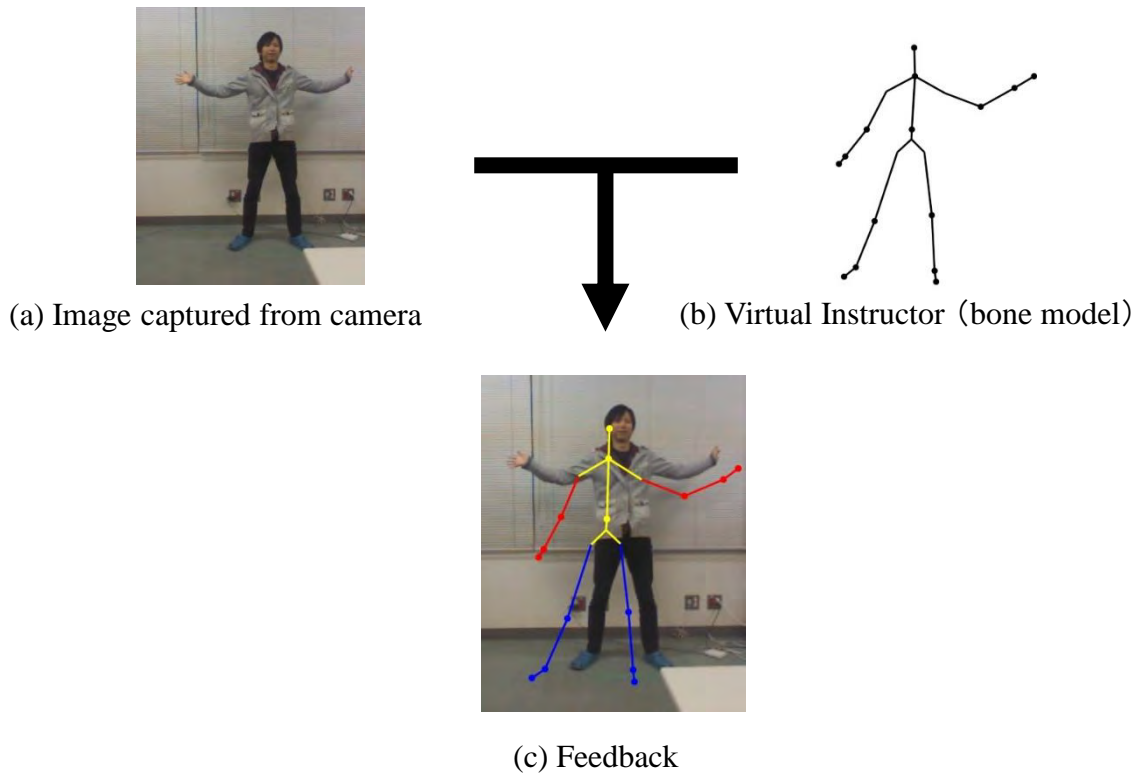

Figure 3. The Feedback Image for the Learner.

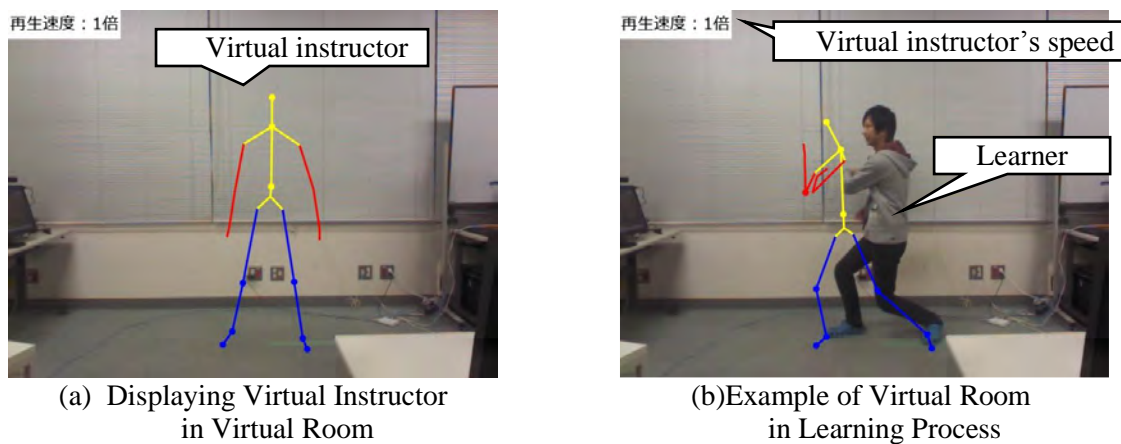
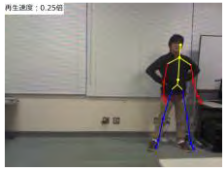

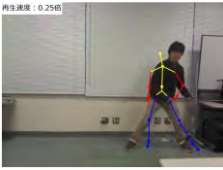

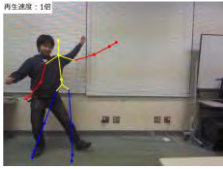
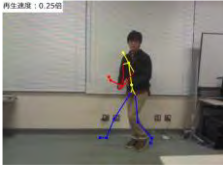

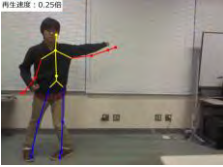

Figure 4. Virtual Room Produced by The System.

of the virtual room, as shown by Figure 4 (b). In the virtual room, adjusting the virtual instructor's speed changes the virtual instructor movement.

In this system, the learner can adjust the speed of the virtual instructor movement. The adjusted movement of the virtual instructor and its normal movement are shown in Table 1. From the images in Table 1, at first, the learner cannot obviously imitate the virtual instructor movement at normal speed. By adjusting the virtual instructor's speed, the learner is expected to imitate the movement. This adjustment is conducted by learner's verbal instructions. Therefore, the learner can adjust the velocity without using his or her hands.

Table 1. Differences of displayed time

time(sec)	adjusted movement(slow)	normal movement
1		
2		
4		
8		
12		
16		

3. Evaluation experiment

3.1 Purpose and Condition

We conducted an experimental evaluation of the system, wherein three types of virtual instructors were prepared (to teach back swing, fore swing and smash). The subjects were three college students (A, B and C) who were inexperienced at soft tennis. The velocity of the virtual instructor for subjects A and B was set at slow speed. The velocity of the virtual instructor for subject C was set at normal speed. The velocity of the slow subject was one-quarter of the normal speed. The subjects imitated the virtual instructor's movement 60 times for each form (total of 180 movements).

3.2 Result

As examples of results of experiment, virtual instructor and subjects' steps about back swing are shown in Figure 5. Red circle and blue circle corresponded to left foot and right foot respectively. Foot positions of subject A and B are similar to the virtual instructor. However foot position of subject C is reverse. By slowing the virtual instructor movement, it was found that the subject can imitate the movement more easily. In addition, examples of subject C are learning results of fore swing and smash are shown in Figure 6 and 7 respectively. In particular, the wrong movement of subject C shows in

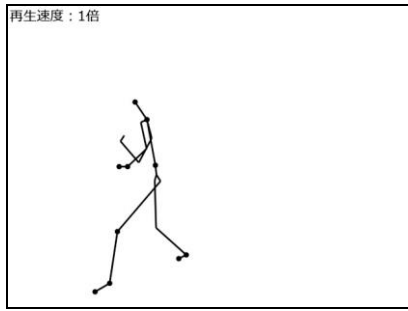

(a) Virtual Instructor



(b) Subject A

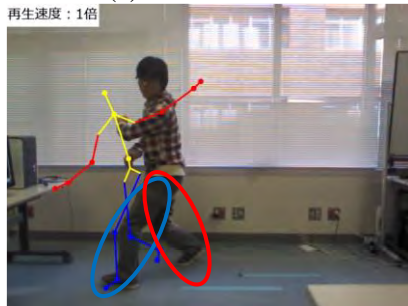

(c) Subject B

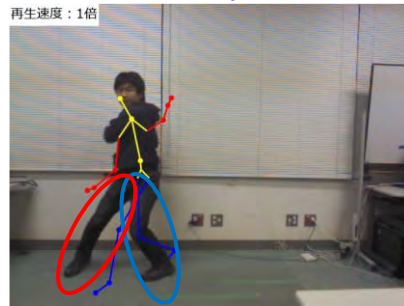

(d) Subject C

Figure 5. Difference of Subjects' Step (form: back swing, time: 3sec).

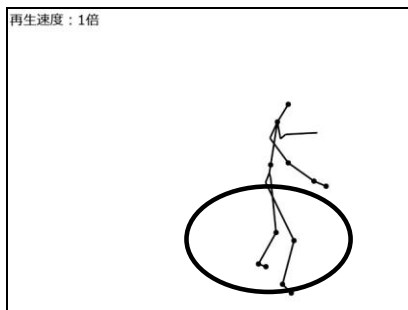

(a) Virtual Instructor

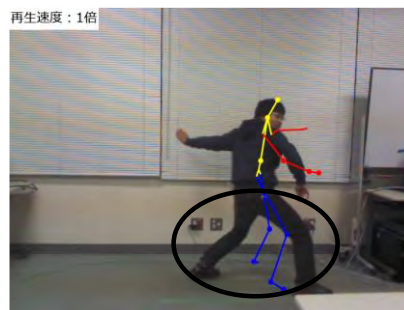

(b) Subject C

Figure 6. Wrong Step of Subject C (form: fore swing, time: 3sec).

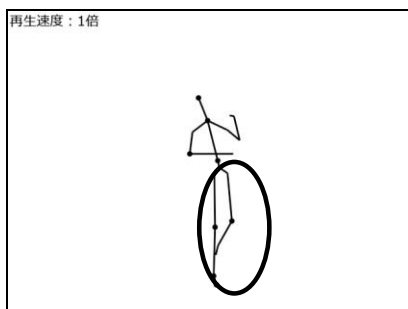

(a) Virtual Instructor

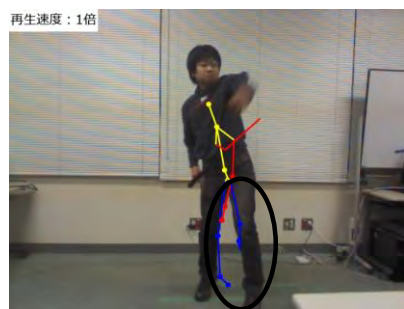

(b) Subject C

Figure 7. Wrong Step of Subject C (form: smash, time: 4sec).

circles in these figures. Although, subject C cannot imitate the virtual instructor movement, it is expected that other subjects can get knowledge of suitable movement from given the virtual instructor. Right movements (fore swing, back swing, smash) have 21 important points (such as positions of feet). By using developed system with slow speed virtual instructor, it is found that subject A can get all points knowledge. Subject B can get 16 knowledge (76%). On the other hand, subjects C can get only 10 knowledge (47%). From these results, it is expected we confirmed possibility that the learner can acquire the skill by imitation the virtual instructor at the slow velocity.

From these results, it is expected possibility that the learner can acquire the skill by imitation the virtual instructor at the slow velocity.

4. Conclusion

This study proposed a skill-learning support method considering the velocity adjustment of the virtual instructor. We developed a system that presents the virtual instructor with velocity adjustment. From the results of the evaluation experiment, we confirmed the possibility that the learner can acquire skills by imitating the virtual instructor at the slow velocity.

In future works we will improve the system by adding other feedback methods (such as voice feedback). In addition, we will need to conduct a detailed evaluation experiment to verify what skills can be taught when a subject chooses to run the virtual instruction at full speed.

Acknowledgements

This work was partially supported by Grant-in-Aid for Young Scientists (B) No. 26750082 from MEXT Japan.

References

- Akazawa, N., Takei, Y., Nakayama, Y., and Kakuda, Suzuki, M. (2013). A Learning Support System for 9 x 9 Multiplication Table with Kinect: *IEEE 2nd Global Conference on Consumer Electronics*, UK, 253-257.
- Anlauff, J., Cooperstock, J., R., Fung, J. (2013). Augmented Feedback for Learning Single-Legged Stance on a Slackline: *International Conference on Virtual Rehabilitation*, PA, 162-163.
- Chuang, T.-Y., Kuo, L.-Y., Lee, I.-C., Tseng, W.-F., & Hsu, Y.-W. (2013). The Design of Kinect Posture Game in Treating Sensory Integration Dysfunction: *Proceedings of the 21st International Conference on Computers in Education*, Indonesia, 608-612.
- Gotoda, N., Matsuura, K., Nakagawa, K., Miyaji, C. (2013). Design of Tennis Training with Shot-timing Feedback based on Trajectory Prediction of Ball: *Workshop Proceedings of the 21st International Conference on Computers in Education, Indonesia*, 196-201.
- Hamagami, K., Matsuura, K., Kanenishi, K. & Gotoda, N. (2012). Support on Repeating-Skill Development –Modulating from monitored data to a target-: *Workshop Proceedings 20st International Conference on Computers in Education*, Nanyang Singapore, 491-498.
- Iwane, N. (2012). Arm Movement Recognition for Flag Signaling with Kinect Sensor: *IEEE International Conference on Virtual Environments Human-Computer Interfaces and Measurement Systems*, Tianjin, 86-90.
- Meng, M., Fallavollita, P., Blum, T., Eck, U., Sandor, C., Weidert, S., Waschke, J. (2013). Kincet for Interactive AR Anatomy Learning: *IEEE International Symposium on Mixed and Augmented Reality 2013 Science and Technology Proceedings*, Australia, 277-278.
- Mitsuhara, H. (2012). An Interactive Digital Signage System Using Live-Video Superimposing and Quiz Slideshow: *Information and Systems In Education*, Japan, 11(1), 62-68.
- Ochi, Y. (2013). Development of an Air-Squat Training Support System Using Microsoft Kinect: *Transactions of Journal of Information and Systems in Education*, 30(1), 98-103.(in Japanese)
- Shih,K.-W., Wu, C.-j., & C, G.-D. (2013). Developing a Well-focused Learning through a Kinect-based Collaborative Setting: *IEEE 13th International Conference on Advanced Learning Technologies*, Beijing, 204-206.
- Sumimoto, T., Okamoto, M., Iwane, N., Matsubara, Y. (2013). Skill Learning Support System based on Augmented Reality: *The Journal of Information and Systems in Education Research Report*, 27(6), 149-152. (in Japanese)
- Tamura, Y., Uehara, M., Maruyama, T., Shima, T. (2013). Feedback of Flying Disc Throw with Kinect: Improved Experiment: *Workshop Proceedings of the 21st International Conference on Computers in Education*. Indonesia, 209-216.
- Thakkar, V., Shah, A., Thakkar, M., Joshi, A., Mendjoge, N. (2012) Learning Math Using Gesture: *IEEE International Conference on Education and e-Learning Innovations*, Sousse, 1-3.
- Yamaoka, K., Uehara, M., Tamura, K., Shima, T. (2012). Capture and Feedback in Flying Disc Throw with use of Kinect: *The Journal of Information and Systems in Education Research Report*, 26(4), 60-63. (in Japanese)

Audio Subtitle Mapping System between Slide and Subtitles by Co-occurrence Graphs on VOD Lecture

Kohei SAKANE^a, Nobuyuki KOBAYASHI^b, Hiromitsu SHIINA^{c*} & Fumio KITGAWA^c

^a*Graduate School of Informatics, Okayama University of Science, Japan*

^b*Faculty of Human Sciences, Sanyo Gakuen University, Japan*

^c*Faculty of Informatics, Okayama University of Science, Japan*

*shiina@mis.ous.ac.jp

Abstract: Many VOD lectures are played alongside a video, making it difficult to understand some content due to mishearing something or not catching the sound on a slide. Therefore, the ability to display audio subtitles that explain data or paragraphs on slides may improve student understanding of some lectures. This system will generate co-occurrence graphs for each paragraph and subtitle on a slide (Microsoft PowerPoint), and depending on the type of co-occurrence graph, and seek correspondence relations. These correspondence relations are used to support understanding of audio information by converting it to textual data and presenting displays and printouts of explanatory information on subtitles for each part of a slide.

Keywords: VOD Lecture, Co-occurrence Word, Mapping Subtitle to slide

1. Introduction

Presentation of video and slides is a basic function of e-learning systems. E-learning systems are increasingly being provided according to SCORM formats (Advanced Distributed Learning; Fallon & Brown, 2003), like Moodle (Dougiamas). Moreover, the effectiveness of e-learning systems has been developed many researches (Kitagawa & Onishi, 2007; Matsumoto, Miyauchi, & Koga, 2010). Moodle is a management system for e-learning systems, and they are continuing to develop a variety of features for it. However, its main purpose is the development of systems and lecture management functions.

In the form of studies related to research concerning lecture content, systems have been developed to conduct summaries of streaming data utilizing colors, caption information, and animation information (Watanabe, Wu, & Yokota, 2010), but the information utilized is unsuitable for use in ordinary lectures. Speech retrieval systems based on techniques utilizing the degree of relevance of subtitles (Itou, Fujii, & Ishikawa, 2001; Mouri, Funabuki, & Nakanishi, 2008), as well as video segment inference systems utilizing techniques that apply statistical processing based on frequency information (Kobayashi, Koyama, Shiina, & Kitagawa, 2011), are under development. Moreover, research on helping students understand content is being conducted with respect to assignment submission management systems (Seki, Matsui, & Okamoto, 2008) as well as writing assignment problems. However, these systems are intended to improve post-lecture understanding. In addition to these, systems development is also being conducted with respect to authoring systems for instructors.

One of the advantages for students taking courses in e-learning systems is the ability to pursue learning in a free environment over a network. For many VOD lectures, content is considered difficult to grasp because the viewer does not know what he or she has missed or how the slides correspond to what is said, as the lectures are simply played back in time with the video. It is thought that development has been slow on systems for making it as easy as possible to understand VOD lectures while watching them, by making lectures more comprehensible using information provided via e-learning systems. Therefore, the ability to display subtitles that explain data or paragraphs on slides may improve student understanding of some lectures. This system will generate co-occurrence graphs for each paragraph and subtitle on a slide (Microsoft PowerPoint, later "PPT"), and depending on the type of co-occurrence graph, seek correspondence relations. These correspondence relations are used to support

understanding of audio information by converting it to textual data and presenting displays and printouts of explanatory information on subtitles for each part of a slide.

2. Audio Subtitle Mapping System Development for VOD Lecture

The system created in this study is being developed as an add-on to an e-Learning lecture system through a VOD system that uses a credit transfer system in an education consortium composed of six universities that centers on okayama university science in Japan.

The system retrieves slide data and audio data from content in the e-learning system, and after converting the audio data into text, associates utterance times and executes a similarity analysis of the slide and subtitles. The system is structured to present video, subtitles, and slide data of VOD lectures stored in a database. Videos display as is, and slides switch in sync with change times while subtitles matching slide text boxes are simultaneously displayed.

As an addition to standard VOD lectures, this system displays video of a lecture with subtitles on the upper left of the screen (Figure 1). In addition, it displays slide on the upper right side and mapping subtitle to text box of PPT.

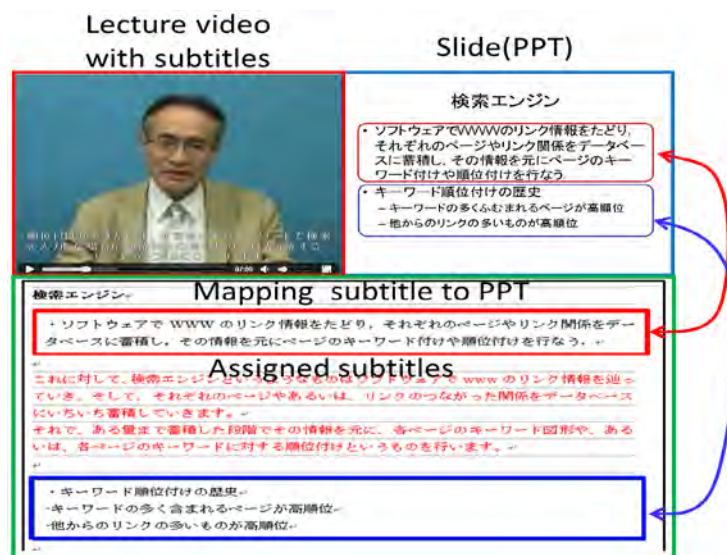

Figure 1. Screen of audio subtitle mapping system.

3. Mapping Subtitles in PPT

3.1 Co-occurrence Words and Co-occurrence Graphs

Co-occurrence words are generally considered words that appear alongside one another in the same text. A co-occurrence graph is generated using each page of a PPT and the subtitles corresponding to each PPT page as targets.

(1) Extracting PPT Co-occurrence Graphs

All descriptors in the PPT are divided into individual text boxes(Figure 2(a)), the retrieved text is partitioned into morphemes using morphological analysis(Figure 2(b)) (Kudo, Yamamoto & Matsumoto, 2004), and a co-occurrence graph(Figure 2(c)) is generated.

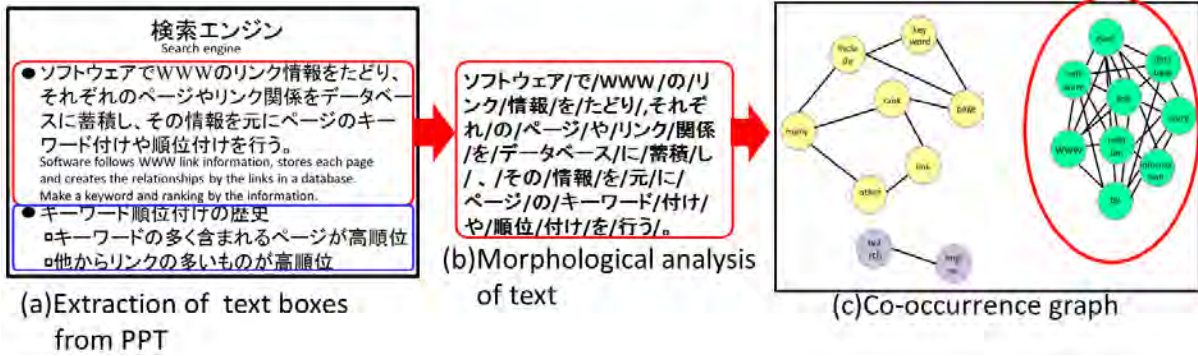

Figure 2. Generation Process of co-occurrence Graph by extracting PPT.

(2) Extracting Subtitle Co-occurrence Graphs

Subtitle co-occurrence graphs are generated by partitioning morphemes in subtitles for individual PPT pages. Then, a graph is generated by linking words that have co-occurrence relations using node and word proximities. Since the word count of a co-occurrence graph of the subtitles on each PPT page can be high, making it more complicated, the word count is refined. Refinement is executed using strength of co-occurrence between words by Jaccard similarity coefficient (Jaccard, 1921; Romesburg, 2004; Tan, Steinbach, & Kumar, 2005), and it eliminates edges of co-occurrence graphs. Finally words with less sum of Jaccard similarity coefficient are also eliminated.

For example, the relations between subtitles and co-occurrence graphs in Figure 3 are used the subtitles from section 2, page 6 of the VOD lecture “Database”. The left side table is list of subtitles, it is divide into each PPT pages. The right side is the co-occurrence graph which is assigned the refined co-occurrence graph to subtitles.

A part of co-occurrence graph which is created from subtitle is eliminated by Jaccard similarity coefficient, some subtitle is also eliminated in mapping system. We are considering that eliminated subtitles are not important. In case of co-occurrence graph is created from some subtitles, these subtitles assign to co-occurrence graph. Then mapping system assign these subtitle to text block of PPT.

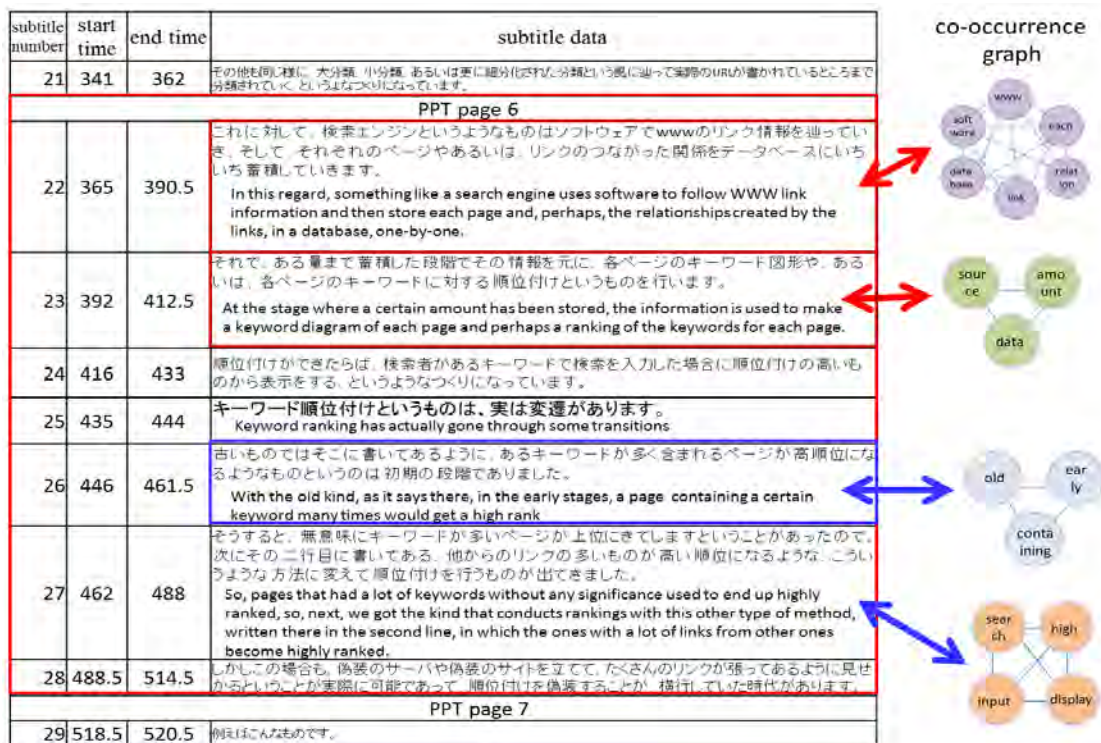

Figure 3. Mapping subtitles to refined co-occurrence graphs.

3.2 Co-occurrence Graph Corresponding Ratios

Based on a search of a corresponding count for the words in a subtitle co-occurrence graph and the words in a PPT co-occurrence graph, a corresponding ratio for the PPT co-occurrence graph and subtitle co-occurrence graph is generated with the following method.

Let C_{PPT} be the number of co-occurrence words in PPT, C_{Sub} be the number of co-occurrence word in subtitles, and $CP(G_{PPT}, G_{Sub})$ be corresponding ratio of G_{PPT} and G_{Sub} .

$$CP(G_{PPT}, G_{Sub}) = \frac{|C_{PPT} \cap C_{Sub}| \times 2}{|C_{PPT}| + |C_{Sub}|}$$

In the PPT and its subtitles from section 2, page 6 of the VOD lecture “Database”, for example, when the word set for the co-occurrence graph created from the PPT $C_{PPT} = \{\text{software, database, WWW, storage, data, relation, source, each, execute}\}$, and the word sets for three types of co-occurrence graphs $G_{Sub1} = \{\text{relation, WWW, software, follow, each, database}\}$, $C_{Sub2} = \{\text{amount, data, source}\}$, $C_{Sub3} = \{\text{search, high, input, display}\}$ the agreement ratios between co-occurrence graphs are $CP(G_{PPT}, G_{Sub1}) = 5 \times 2 / (9 + 6) = 2 / 3 = 0.6667$, $CP(G_{PPT}, G_{Sub2}) = 2 \times 2 / (9 + 3) = 1 / 3 = 0.3333$ and $CP(G_{PPT}, G_{Sub3}) = 0 \times 2 / (9 + 4) = 0 / 13 = 0.0000$. Figure 4 shows relation between co-occurrence graphs of PPT and subtitles.

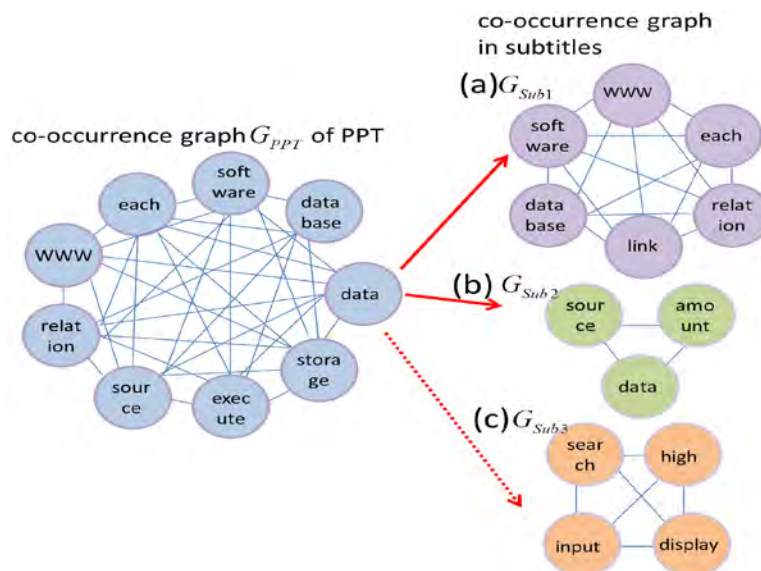

Figure 4. Corresponding ratio between PPT and subtitles

Summary which is not assign to text block of PPT is created. The ratio of summary original subtitles is defined the number of subtitle of summary divided by the number of original subtitles.

3.3 PPT and Subtitle Co-occurrence Words

Lastly, subtitle co-occurrence graphs with higher thresholds are correlated with PPT co-occurrence graphs, and subtitle co-occurrence graphs with lower thresholds are eliminated.

In the PPT and its subtitles from section 2, page 6 of the VOD lecture “Database”, for example, while the agreement ratios between co-occurrence graphs are 0.6667, 0.3333, 0.0000, co-occurrence graphs with an agreement ratio with a threshold lower than 0.2 are removed from correspondence relations with PPT. An example of a PPT and subtitle co-occurrence graph is shown in Figure 5. In Figure 5, subtitle co-occurrence graphs corresponding to PPT co-occurrence graphs are encircled by the same color.

Summary which is not assigned to text block of PPT is created. The compression ratio of summarization is defined as the ratio of number of sentences in assigned subtitle to the number of sentences in the original subtitles. In an example of the compression ratio of summarization for subtitles from section 2, page 6 of the VOD lecture “Database”, the compression ratio of the subtitles except the page only for title page and figures was: minimum is 0.167, maximum is 0.6 and average is 0.38.

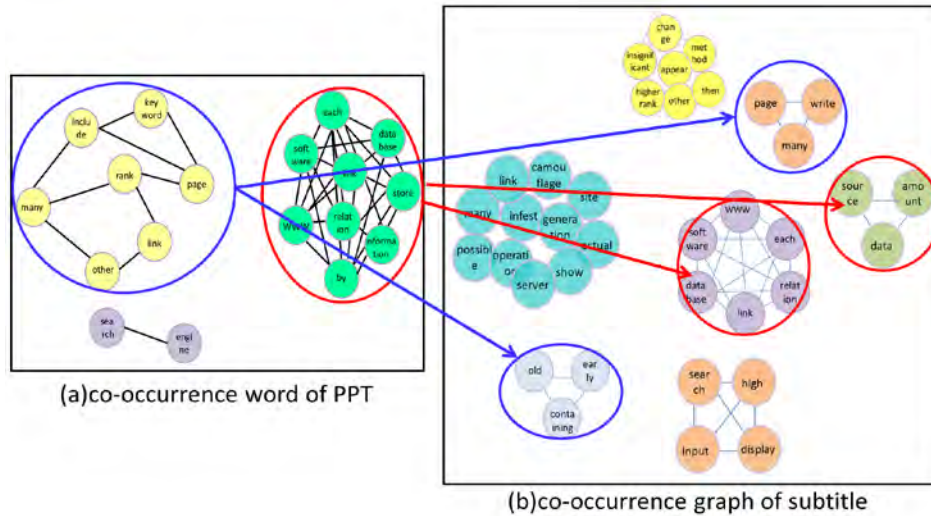

Figure 5. Refined mapping co-occurrence graph of PPT and subtitles.

4. Evaluating Subtitle and PPT Correspondence Relations

Correspondence relations between PPT and subtitles from section 2, page 6 of the VOD lecture “Database” were evaluated by Japanese students. The evaluation method was in two parts. The first was to rate the match level of corresponding subtitles at one of four levels: skewed, slight, frequent, and consistent. The second was to evaluate them as captions by assigning a rating out of five (1, 2, 3, 4, 5). Table 1 is result of evaluations.

Table 1: Evaluation by questionnaires.

PPT page number	Evaluation1		Evaluation2	
	P1	P2	P1	P2
No. 1(title page)	-	-	-	-
No. 2	consistent	5	consistent	5
No. 3	slight	3	slight	3
No. 4	slight	3	slight	4
No. 5	consistent	5	slight	2
No. 6	slight	2	slight	2
No. 7	slight	2	slight	2
No. 8	slight	3	slight	3
No. 9	slight	1	slight	1
No. 10	slight	5	skewed	4
No. 11	skewed	1	skewed	1
No. 12	consistent	5	consistent	5
No. 13 (figure page)	-	-	frequent -	-
No. 14	frequent	4	slight	4
No. 15	slight	3	slight	4
No. 16	consistent	5	consistent	5
No. 17	slight	4	consistent	5

Ratings as captions were given according to the degree that the subtitles adhered to the content, with half or greater adherence receiving a rating of three or higher. For correspondence relations in

which the level of corresponding subtitles were judged “slight,” strict refinement when generating a co-occurrence graph was also taken into consideration.

5. Future Works

This system generates co-occurrence graphs from PPT and subtitles in PPT of VOD lecture for the purpose of facilitating student comprehension of lectures. Going forward, this system must be used, with foreign students as a target user ship, in order to evaluate its efficacy. We would also like to create a system that helps students gain a deeper understanding of lectures by generating summaries from PPT-compatible subtitles.

As future works, the subtitles will also possess the ability to add readings of kanji (Chinese characters) to assist foreign students. In addition, research of learning of terminology has been derived (Sun, Kashiwagai, Kang, Kiyomitsu, & Ohtsuki, 2011). As future research, we are considering that extracting data of terminology from actual lecture and developing learning system for terminology using its extract data.

References

- Advanced Distributed Learning. *Advanced Distributed Learning Initiative: SCORM 2004 4th Edition*. Retrieved 8 20, 2014, from Advanced Distributed Learning: <http://www.adlnet.org/scorm/scorm-2004-4th/>
- Dougiamas, M. *moodle*. Retrieved from moodle: <https://moodle.org>
- Fallon, C., & Brown, S. (2003). *e-Learning Standards: A Guide to Purchasing, Developing, and Deploying Standards-Conformant E-Learning*. Florida: CRC Press.
- Fujita, A., & Ishikawa, T. (2002). Extraction and Organization of Encyclopedic Knowledge Information Using the World Wide Web. *The IEICE Transactions(Japanese Edition), J89-D(9)*, 300-307.
- Ito, K., Fujii, A., & Ishikawa, T. (2001). A Lecture-On-demand System using Spoken Document Retrieval. *IEICE Technical Report*, 55-60.
- Jaccard, P. (1921). The distribution of the flora in the alpine zone. *New Phytologist*, 37-50.
- Kitagawa, F., & Onishi, S. (2007). An Experiment on selective Course with Face-to-Face or/and E-learning, and Students Behavior. *Japan Society of Education Information*, 22(3), 57-66.
- Kobayashi, N., Koyama, N., Shiina, H., & Kitagawa, F. (2011). Detecting Movie Segments Using Gaussian Mixture Models for VOD Lectures with. *The Journal of Information and System in Education*, 10, 39-46.
- Kobayashi, N., Shiina, H., & Kitagawa, F. (2009). A Search System by Word Frequency Distribution for a VOD Lecture with Subtitles. *IPSJ SIG Technical Reports, 2009-DBS-149(7)*, 1-9.
- Kudo, T. Retrieved 8 20, 2014, from MeCab: Yet Another Part-of-Speech and Morphological Analyzer: <http://mecab.googlecode.com/svn/trunk/mecab/doc/index.html>
- Kudo, T., Yamamoto, K., & Matsumoto, Y. (2004). Applying Conditional Random Fields to Japanese Morphological Analysis. *Proceedings of the 2004 Conference on Empirical Methods in Natural Language Processing (EMNLP-2004)*, 230-237.
- Matsumoto, K., Miyauchi, H., & Koga, A. (2010). Adapting the Drill-and-practice-type e-Learning System SANNON KNOWLEDGE FIELD to SCORM Standards and Developing Its Contents. *The Journal of Information and Systems in Education*, 85-100.
- Mouri, A., Funabuki, N., & Nakanishi, T. (2008). A Proposal of a Classification and Link Method of Lecture Scenes for Structured Learning. *IPSJ SIG Technical Reports, 2008-CE-93(12)*, 87-98.
- Romesburg, H. C. (2004). *Cluster Analysis for Researcher*. NORTH CAROLINA: Lulu. com.
- Seki, K., Matsui, T., & Okamoto, T. (2008). An Adaptive Sequencing Method of the Learning Objects for the e-Learning Environment. *The IEICE Transactions D, J86-D1(5)*, 330-344.
- Sun, Y., Kashiwagai, H., Kang, M., Kiyomitsu, H., & Ohtsuki, K. (2011). A Presenting Method Suited to Learners' Understandings in the Use of IT Dictionary. *Transactions of Japanese Society for Information and Systems in Education*, 28(4), 271-282.
- Tan, P., Steinbach, M., & Kumar, V. (2005). *Introduction to Data Mining*. Boston: Addison-Wesley.
- Watanabe, Y., Wu, Y., & Yokota, H. (2010). Digesting Online Multimedia Presentation Archives Based on Visual Effects. *Proc. Int. Workshop Streaming Media Delivery and Management Systems, SMDMS*, 477-482.

Code Reading Environment according to Visualizing both Variable's Memory Image and Target World's Status

Satoru KOGURE^{a*}, Ryota FUJIOKA^a, Yasuhiro NOGUCHI^b, Koichi YAMASHITA^c
Tatsuhiko KONISHI^a, & Yukihiro ITOH^d

^a*Graduate School of Informatics, Shizuoka University, Japan*

^b*Faculty of Informatics, Shizuoka University, Japan*

^c*Faculty of Business Design, Hamamatsu University, Japan*

^d*Shizuoka University, Japan*

*kogure@inf.shizuoka.ac.jp

Abstract: In this paper, we describe the code reading environment according to visualizing both variable's memory image and target world's status. We had constructed those environment that have two important function. One is the function by which the teacher can reflect his/her intention for instruction on the view of target world's status. Another is the function by which the programming beginner can more deeply understand a program using our proposed environment.

Keywords: Code reading environment

1. Introduction

We think that it is for novice programmers important to understand the relationship between the algorithm and the program in code reading phase observing both memory image of variables in program and status of target worlds. In typically, almost all of novice programmer attend a lecture using educational materials that is included in target world dependency. The beginner can reproduce the status of target world (STW) using the materials. In contract, expert programmer also can analyze a memory image of variables (MIV) in programs step-by-step using typical debugger. In case of simple calculation's task, the representation of STW and MIV are almost same. Although, in case of complex algorithm or data structure, the STW have different representation from MIV. The expert programmer can estimate the STW by observing the MIV using debugger in a program that includes complex algorithm or data structures. Although the beginner programmer cannot because he/she cannot understand the relationship among program, STW and MIV.

Many systems that support to understand the program and algorithm for novice programmer had constructed by many researcher (Fossati *et al.* (2008), Gabor (2009), Kogure *et al.* (2013), Malmi *et al.* (2004) and Noguchi *et al.* (2010)). We think that these systems have two issues. First issue is that the teacher cannot freely decide the format visualizing the STW. Some systems can reproduce the STW in any step in programs. In those system, although, the teacher cannot reflect his/her intent for instruction to the view of STW. Second issue is that the learner cannot show the STW and MIV synchronously. Almost all system can show the STW for particular algorithm. In the other hand, typical debugger can show the MIV for almost all program that is written for a variety of algorithm. Although, some systems and debugger cannot display the relationship among program, STW and MIV.

The aim of this study is to solve the issues. We had constructed new code reading environment according to visualizing the relationship among a statement of program, STW and MIV for novice learner. This environment has two important function and three basis function. One important function is the function that gives the teacher an environment by which he/she can define the view of STW according to his/her intent. Another is the function that gives the learners an environment by which they can understand the relationship among program, STW and MIV.

2. Fundamental Consideration

2.1 Definition of the State of Target World and the Memory Image of Variables

We think that there are two views for visualizing a behavior of program. One is a state of target world (STW) and another is a memory image of variables (MIV). Figure 1 shows an example of STW and MIV for task of sorting values in array list. As mention in Figure 1, it is easy for novice programming learners to understand a behavior of algorithm using a view of STW instead of a view of MIV. In fact, many systems that support to understand the program and algorithm for novice programmer support a view of STW (Fossati *et al.* (2008), Gabor (2009), Kogure *et al.* (2013), Malmi *et al.* (2004) and Noguchi *et al.* (2010)). In contrast, programming learners must observe a view of MIV to deeply understand a behavior of program or to fix a program that includes a bug.

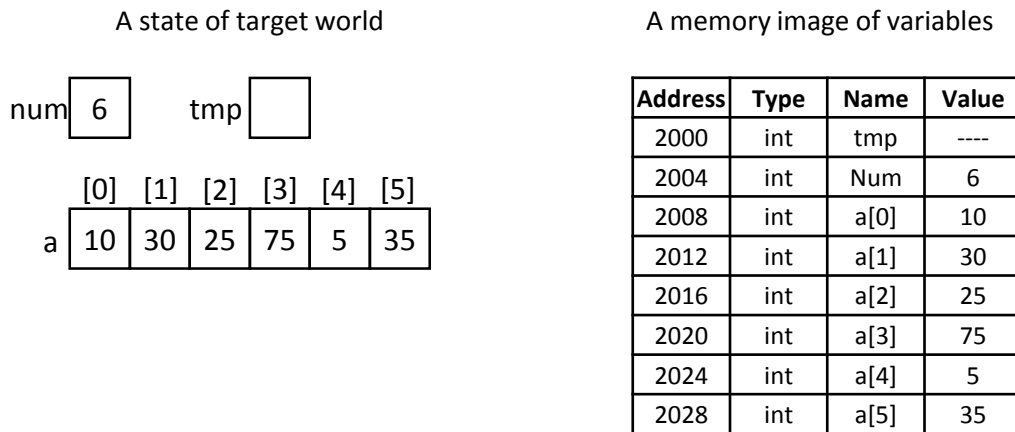

Figure 1. An example of a state of target world and a memory image of variables.

2.2 The Issue that the Teacher cannot Freely Decide the Format Visualizing the STW

Almost all of studies for viewing a STW was for particular algorithm. Some studies' STW don't depend on a particular algorithm but also teacher cannot define a view form of STW. In a case of displaying array list for sorting task, teacher maybe display the array list on horizontal layout (in Figure 1). In contrast, he/she maybe display the array list on vertical layout for stack. Furthermore, the teacher want to change a view of each variable to emphasize the particular variable or to hide some variables. For example, the teacher maybe think that he/she want to hide a view of the variable "tmp" (in Figure 1) for swapping the values of two variable from programming learners. Therefore, we gives the teacher an environment by which he/she can define the view of STW according to his/her intent.

2.3 The Issue that the Learner cannot Show the STW and MIV Synchronously

Almost all of exist studies can show a statement of program and STW synchronously. Typical debugger can show a statement of program and MIV synchronously. Although almost all of exist systems cannot display a statement of program, STW and MIV synchronously. Novice programming learners can easily understand a behavior of program using exist systems that can display a view of STW. Although he/she maybe not understand a behavior of program using debugger that can display a view of MIV. In contrast, an expert programmer maybe understand a behavior of program using debugger. The difference of novice and expert is whether to be able to understand the relationship among a statement of program, STW and MIV or not. Therefore, we gives the learners an environment by which they can understand the relationship among program, STW and MIV.

3. Required Functions for Our Proposed Environment

In order to solve two issues, we define the following five functions for code reading environment:

- Func.1. A function that extracts execution history (EH) from a program and generates a program embedded HTML tags for each statement
- Func.2. A function that reproduce MIV by using extracted EH
- Func.3. A function that give the teacher the environment by which he/she can set the form for the view of the STW for solving first issue.
- Func.4. A function that reproduce STW by using MIV and the rule for the view of the STW
- Func.5. A function that displays the statement in program, MIV and STW synchronously for solving second issue

There are two types of functions; basis function and important function. Func.1, 2 and 4 are basis functions that we implement using exist methods. Func.3 and 5 are important functions for solving two issues.

3.1 Func.1: A Function that Extracts EH from a Program and Generates a Program embedded HTML Tags for Each Statement

This function is the function that translates a program into two different programs shown in Figure 2. First program includes the code for generation execution history including statement ID and dynamic history ID. The module for this function gives the fragment of statements the unique statement ID when parsing original program. In contrast, the module generates the statement for observing execution state and insert observation statement in original programs. The observation statement dynamically generates history ID when revised program executes. Second program includes the HTML tags for each fragment of statements. The proposed system can display the fragment in program embedded HTML tags and memory image of variable referring execution history synchronously because the statement ID in program embedded HTML tags correspond to the statement ID in execution history.

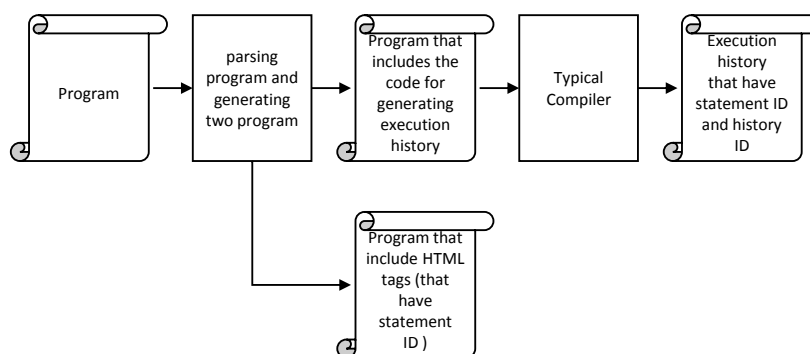

Figure 2. Overview of extracting execution history from a program and generating a program embedded HTML tags.

3.2 Func.2: A function that Reproduce a MIV by Using Extracted EH

This function reproduces the state of executing program by referring execution history (Func.2.1) and displays the memory image of variables (Func.2.2). Func.2.1 generates a set of memory image of variables MIV by referring EH ($EH = \{eh_1, eh_2, \dots, eh_n\}$) shown in Figure 3.

The certain memory image of variables miv_i includes a set of the four variable information; defined variables' name, types of variables, addresses of variables and values of variables when the system executes from eh_1 to eh_i . EH includes five fundamental operation as follows:

- An operation that allocate memory region for new variable
- An operation that assign new value

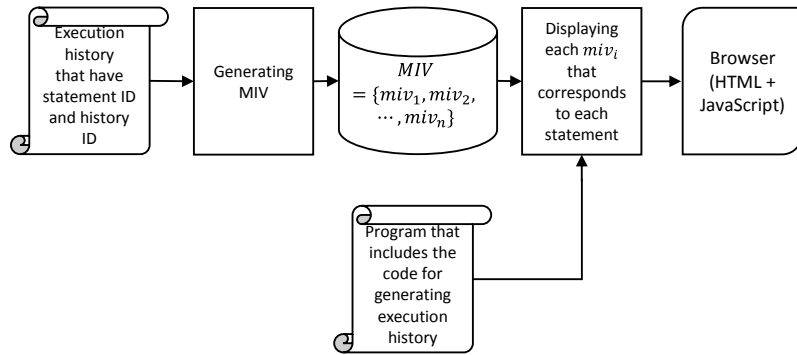

Figure 3. Overview of reproduce MIV by using extracted EH.

- An operation that allocate memory region for new instance of certain structure (e.g. “struct” in C language, “class” in Java language, etc.)
- An operation that clear memory region for exist variable
- An operation that clear memory region for exist instance

This function is generate the MIV set using the Algorithm 1.

Algorithm 1: generating the MIV

- 1: $EH \leftarrow \{eh_1, eh_2, \dots, eh_n\}$: execution history
 - 2: $MIV \leftarrow \{\}$: set of memory image of variables
 - 3: $cmiv \leftarrow \{\}$: a memory image of variables after executing from eh_1 to eh_i
 - 4: **for** $i=1$ **to** n **do**
 - 5: Emulate eh_i on memory image $cmiv$.
 - 6: Push emulate result to $cmiv$.
 - 7: $miv_i \leftarrow clone(cmiv)$
 - 8: push miv_i to MIV
 - 9: **end for**
-

3.3 Func.3: A Function that Give the Teacher the Environment by which he/she can Set the Form for the View of the STW

First, we define the two types of object that the teacher use for composing a view of STW. First type is a main object that directly correspond to a variable in program. Second type is a sub object for explaining a role of a main object, explaining a relationship between a main object and other main object, or setting an array/table layout of each object. The teacher can specify each attribute value (e.g. object’s position, size, color, and so on) of each object. Therefore, the teacher can set a timing in which an object creates, deletes, shows and hides by using statement ID or history ID.

The teacher prepares the configuration file for a view of STW described above paragraph. Table 1 shows the content of configuration that teacher describes for main/sub objects and timing of creating/deleting/displaying/hiding each object.

Table 1: Types of object and Attributes for Configuration of STW.

	Operations	Types	Common Attributes
Main Object	Create, Delete Update	Circle, Square Rectangle	Corresponded variable, Position, Width, Height, Color, Line weight Line style
Sub Object	Create, Delete Update	Connector, Table Label, Line, Balloon	Target main object ID, Position, Width, Height, Color, Line weight Line style

The teacher can use three types of actions described in Table 1. “Create” action of main object is an action when observing an execution history in which a new variable is created. “Delete” action of main object is an action when observing an execution history in which an existed variable is cleared. “Update” action is an action for changing any attribute (e.g. color for emphasizing) at any timing that the teacher decides using statement ID or history ID).

The teacher can also use sub object in Table 1 for explaining a role of a main object or a relationship between a main object and other main object. For example, “Connector” type is a connector that connect a main object to other main object. The teacher can present the reference relation using attribute “Line style” (e.g. arrow). “Balloon” type is a balloon help for a main object.

The a rule description of rule set for a view of STW includes five items; “condition”, “operation”, “object name”, and “set of attribute-value”. “Condition” item is for specifying a timing of adapting the rule. The teacher can use six comparison operation; “==”, “!=”, “>=”, “<=”, “>” and “<” and three types of operands; “immediate number”, “variable in program” and “statement or history ID”.

3.4 Func.4: A Function that Reproduce STW by using MIV and the Configuration for the View of the STW Created by the Teacher

The system reproduce certain stw_i according to miv_i and configuration rule set for the view of the STW created by the teacher. The system find rules in which a comparison operation is satisfied. If the system find match rule, the system executes this rule. If this rule is “create” operation’s rule for main object, the system retrieve a value of variable corresponding the rule from miv_i and display a main object according to object name, variable value and a set of attribute-value.

3.5 Func.5: A Function that Displays the Statement in Program, MIV and STW synchronously

Learners can show a reproduced execution process of program code using our proposed environment. Our proposed system have execution history, EH, as common knowledge that each function use for executing own affair. Learners can use “next” or “prev” command for moving focused execution history eh_i to next execution history eh_{i+1} or previous execution history eh_{i-1} . Therefore, the system reproduces miv_{i+1} or miv_{i-1} for memory image of variables and also reproduces stw_{i+1} or stw_{i-1} for a state of target world.

4. Implementation

Figure 4 shows an overview of our proposed environment. First, the left side area is for displaying program. Second, the right/top side area is for displaying a memory image of variables. Last, the right/bottom side area is for displaying a state of target worlds. In this study, target programming language is C language. We implement the parser of C language using Parse::RecDescent (Perl module for generate recursive-descent parser, referring <http://search.cpan.org/~jtbraun/>) and we implement the other module using HTML and JavaScript. We use JSON format as the representation of execution history.

For primary evaluation, we monitored what minutes the one of author spends creating the rule set for a view of STW. We select three situation; binary search task, linked list task, and other linked list task. As a result of evaluation, we obtained 36, 48 and 37 minutes, respectively. Therefore, we suggest that the teacher and learners maybe can use our environment in real classroom lecture.

5. Conclusion

We had constructed new code reading environment according to visualizing the relationship among a statement of program, STW and MIV for novice learner. This environment has two important function. One important function is the function that gives the teacher an environment by which he/she can define the view of STW according to his/her intent. Another is the function that gives the learners an

environment by which they can understand the relationship among program, STW and MIV. We easily evaluate first important function. As a result, we suggest that the teacher and learners maybe can use our environment in real classroom lecture.

In the future, we will refine the second important functions. Therefore, we will evaluate the advantage of our proposed two function on real classroom lectures.

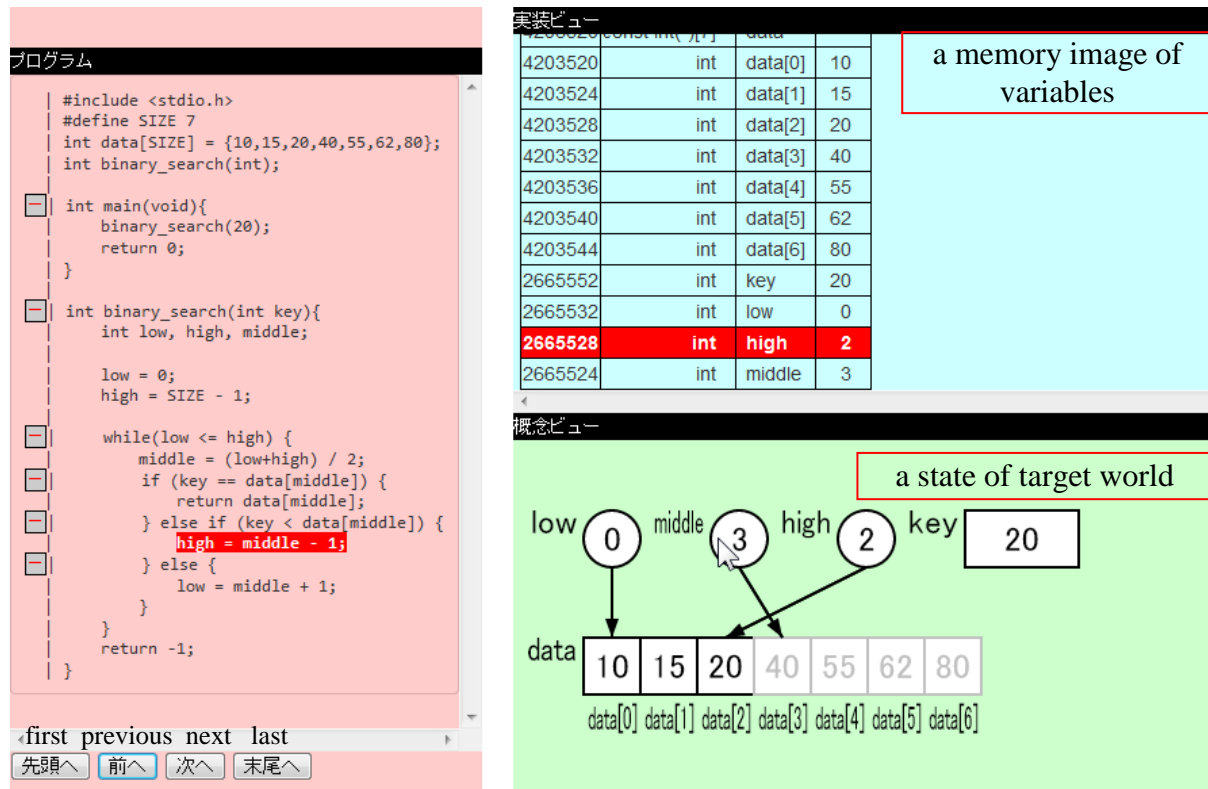

Figure 4. Overview of our proposed environment.

Acknowledgements

This study was supported by Japanese Grant-in-Aid for Scientific Research (B) 24300282.

References

- Fossati, D., Eugenio, B. D., Brown, C., & Ohlsson, S. (2008). Learning linked lists: experiments with the iList system, *Proceedings of the 9th International Conference on Intelligent Tutoring Systems*, 80-89.
- Gabor, T., (2009). Algorithm visualization in programming education,. *Journal of Applied Multimedia*. 4(3), 68-80.
- Kogure, S., Okamoto, M., Yamashita, K., Noguchi, Y., Konishi, T., & Itoh, Y. (2013). Adapting guidance and externalization support features to program and algorithm learning support environment. *Proc. of the 21st International Conference of Computers in Education*, 418-424.
- Malmi, L., Karavirta, V., Korhonen, A., Nikander, J., Seppala, O. & Silvasti, P. (2004). Visual algorithm simulation exercise system with automatic assessment: TRAKLA2, *Informatics in Education*, 3(2), 267-288.
- Noguchi, Y., Nakahara, T., Kogure, S., Konishi, T., & Itoh, Y. (2010). Construction of a learning environment for algorithm and programming where learners operate objects in a domain world?, *International Journal of Knowledge and Web Intelligence*, 1(3), 273-288.

Computer Assisted Learning based on ADDIE Instructional Development Model for Visual Impaired Students

Sasithorn CHOOKAEW*, Suppachai HOWIMANPORN, Warin SOOTKANEUNG,
Wanida PRADUBSRI & Piyawat YOOTHAI

Faculty of Industrial Education, Rajamangala University of Technology Phra Nakhon, Thailand

*sasithorn.c@rmutp.ac.th

Abstract: With the advancement of technological innovations for ICT in education, this study focuses on building effective computer assisted learning based on the framework of ADDIE instructional development model to improve visual impaired students' conceptual learning progression on Marketing course. To examine the effectiveness of the developed computer assisted learning, an experiment was conducted by assigning twenty-four diploma students into three groups consisting of five blind students, seven partial visual impaired students, and twelve non-visual impaired students. They are permitted to select the learning instructions regarding to their vision level. The results of this study show that the developed computer assisted learning could help the students improve their conceptual learning progression. Additionally, the students reveal positive satisfaction towards the developed computer assisted learning.

Keywords: visual impairment, computer assisted learning, diploma program, ICT in education

1. Introduction

With the advancement of technological innovations for information technology and communication (ICT) in education, current research indicates a great impact on education, especially, computer assisted learning (CAL) can help improve the ability of students who have the different educational levels. (Basturk, 2005; Chang, Sung, Chen, & Huang, 2008; Denny, 2003; Ecalle, Kleinsz, & Magnan, 2013; Liu, 2010; Seo & Woo, 2010). Recently, a number of educators have attempted to study technological innovations for ICT to improve learning performance of visual impaired students (Ager & Aalykke, 2001; Douglas, 2001). There are two types of visual impaired students such as blind and partially sighted who have different learning patterns and difficulties, and may require different kinds of support (Shepherd, 2001). Several studies suggested that learning objects could engage the visual impaired students and promote their learning performance (Barak & Ziv, 2013; Basturk, 2005; Gaeta et al., 2004; Pinhati & Siqueira, 2014; Shepherd, 2001)

In Thai educational contexts, an attempt to provide learning support to the visual impaired students and non-visual impaired students has been promoted continuously. They are anticipated to be able to learn together. In addition to this context, Nakornluang Polytechnic College, one of many educational institutes in Thailand, offers educational system to both visual impaired students and non-visual impaired students learning together in the same classroom. However, it has been found that there are insufficient supplement learning materials and learning contents for visual impaired students. This is might be because of the lacking of well-designed learning materials.

Researchers have attempted to design learning objects based on instructional development models, for example, Bloom's Learning Taxonomy (Chyung & Stepich, 2003), Gagné's Nine Events of Instruction (Gagne, Wager, Golas, & Keller, 1992). Such models help educators to manage learning unit for the most effective learning environments. Among the instructional development models, the ADDIE instructional design model represent a more dynamic and flexible guidance for developing learning objects (Melanie, 2008; Ozdileka & Robeckb, 2009). Consequently, we developed a computer assisted learning environment for visual impaired students. Much than that the ADDIE instructional development model has been applied to the environment to form supplement

learning materials which are used to facilitate visual impaired students learning and promote their conceptual learning progression.

2. Development of computer assisted learning

In the process of developing computer assisted learning (CAL), we applied five steps of the ADDIE instructional development model, including Analysis, Design, Development, Implementation, and Evaluation (Melanie, 2008; Ozdileka & Robeckb, 2009). The analysis phase involves the investigation of students; we analyze content and presentation in order to design learning instruction appropriately. For the design phase; we designed the learning objects. In the development phase; the interactive instructions were created by Adobe Flash CS5.5 program, Adobe Photoshop CS5.5 program, and Nero Wave Editor program. In the implementation phase; this addresses the execution of the instructions. Finally, in the evaluation phase; the summative assessment function has been embedded.

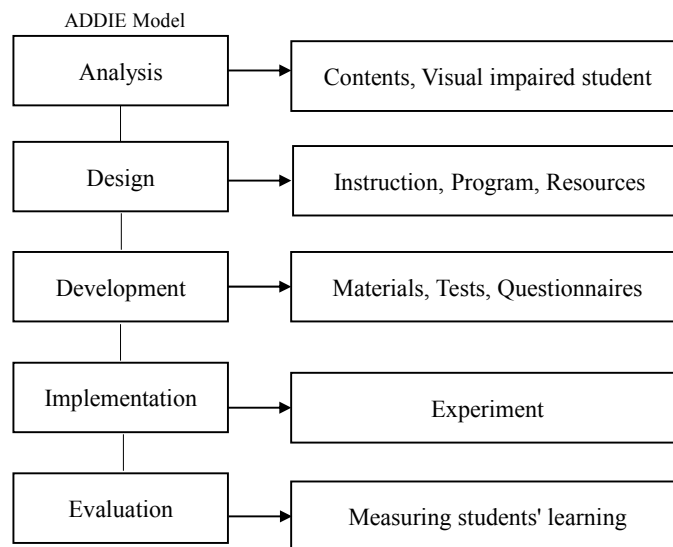

Figure 1. Development of computer assisted learning based on the ADDIE model

This paper presents CAL to help the visual impaired students and non-visual impaired students to learn together in a Marketing Course. The learning contents were separated into three units consisting of Unit 1: the importance of selling and marketing concepts; Unit 2: the types and characteristics of the selling; and Unit 3: the basic of products and business.

From analysis, we found the non-visual impaired students can learning normally while partial visual impaired students can see in certain conditions but they take longer to read it. The blind students like to have to rely on listening rather than watching. Therefore, the researchers developed instructional materials appropriately each student' types.

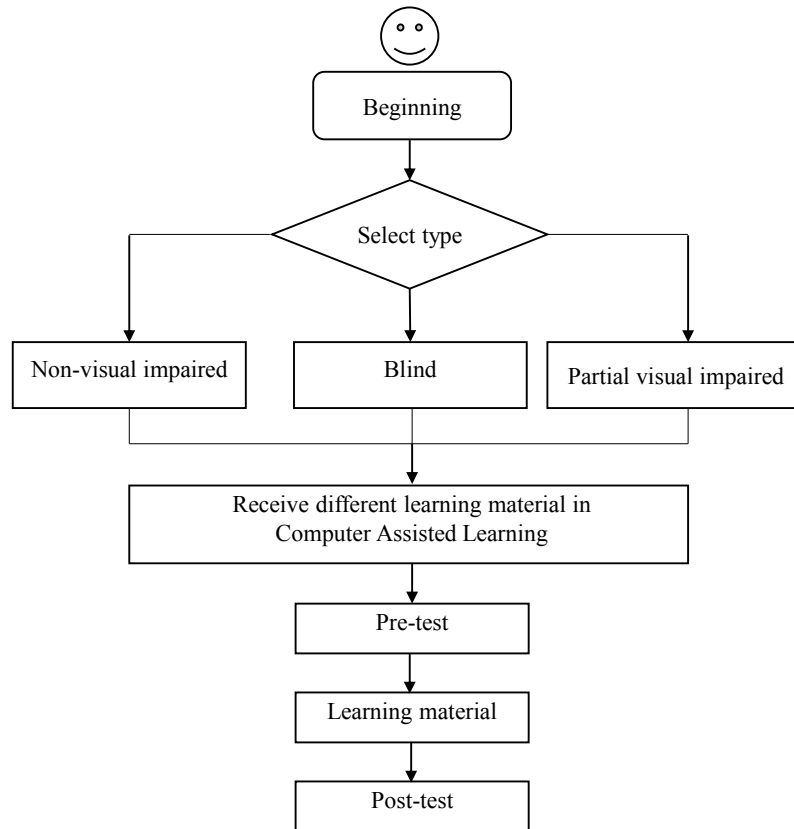

Figure 2. Design model of computer assisted learning system

Figure 2 shows that the students can select the appropriate instruction fit with their level of vision. Non-visual impaired students participated in instructions which are normal texts, pictures and sound, in which they can interactive via monitor as shown in Figure 3. The partially visual impaired students participated in instructions which are larger texts, pictures, and sound in which they can interactive via monitor as shown in Figure 4. On the other hand, the blind students participated in instructions which are only sound in which they can only interactive via keyboard; if they want to link to other pages, they can press button on keyboard following the listening instruction. Every type of instruction has different activities to enhance students' remembering as well.

3. Research design and method

Twenty-four visual-impaired Thai students from a University of Technology were recruited in this study to examine the effectiveness of the developed CAL. They were diploma students and were divided into three groups consisting of five blind students, seven partial visual impaired students, and twelve non-visual impaired students. They are permitted to select the learning instructions regarding to their vision level. One group pre-and post-test research design was used in this study. Before participating the developed CAL, they took a pre-test to measure whether they had equivalent prior knowledge. After taking the developed CAL, they took a post-test to evaluate learning performance, followed by the satisfaction questionnaire toward the developed CAL.



Figure 3. Illustrative examples of instructions for non-visual impaired students

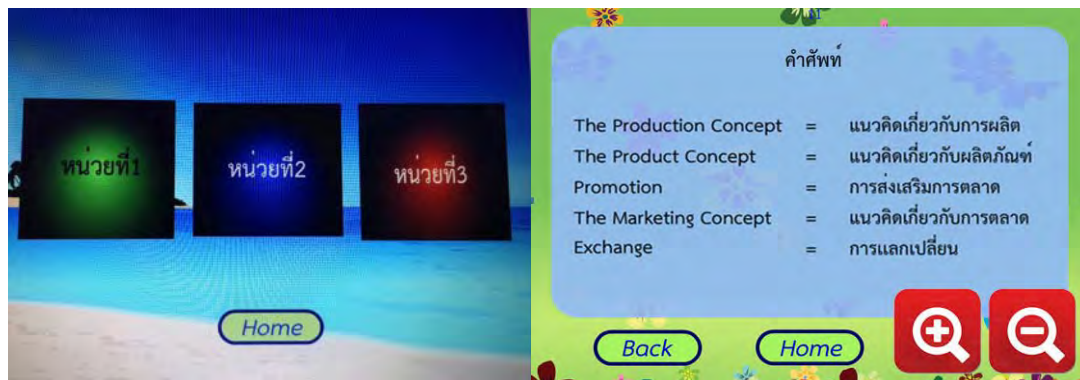

Figure 4. Illustrative examples of instructions for partial visual impaired students

4. Results

Table 1 shows the mean scores and standard deviations of the pre-test scores of non-visual impaired students, partial visual impaired students, and blind students, which are 9.67, 9.43, and 9.8, respectively. The researchers have found that three groups of students had equivalent prior knowledge before participating in the learning activity. After finishing the learning activity, the post-test scores were 20.67, 22.71, and 23.6 for non-visual impaired students, partial visual impaired students and blind students, respectively.

The normalized gain ($\langle g \rangle$) (Hake, 1997, 2002) is employed to investigate students' conceptual learning progression. The range is that if the $\langle g \rangle \geq 0.7$ meaning High progression, while $0.7 > \langle g \rangle \geq 0.3$ meaning Medium progression, and $\langle g \rangle < 0.3$ meaning Low progression. Observing the Table 1, the results shows that all groups of students gained better conceptual knowledge after participating in the developed CAL and the progression of their knowledge was reasonably medium, indicating that they gain conceptual knowledge of the importance of selling and marketing concepts, the types and characteristics of the selling, and the basic of products and business in the medium size.

Table 1: The student scores in this study

Group	N	Tests	Mean	SD	Normalized gain	Interpretation
Non-visual impaired	12	pre-test	9.67	2.96	<g> = 0.54	Medium progression
		post-test	20.67	3.39		
Partial visual impaired	7	pre-test	9.43	2.23	<g> = 0.65	Medium progression
		post-test	22.71	2.56		
Blind	5	pre-test	9.80	2.59	<g> = 0.68	Medium progression
		post-test	23.60	2.61		

Moreover, when we asked the participating students to report their own satisfactions about the developed CAL, we found that they had positive satisfaction toward the developed CAL which fit with their learning as shown in Table 2.

Table 2: The students’ satisfactions toward the developed CAL

Non-visual impaired students	
Student A	“I like the CAL, I can learn and repeat instruction every time.”
Student B	“It makes the learning interesting.”
partial visual impaired students	
Student C	“CAL, it is convenient for me to learning, I can zoom in and zoom out the pictures and texts.”
Student D	“I enjoy the CAL.”
Blind students	
Student E	“I think I can learn instruction seem my friends and it easy for me to use computer.”
Student F	“Normally, I don’t have instruction. I like it, CAL.”

5. Conclusions

This study developed the computer assisted learning (CAL) based on the five phases of ADDIE instructional model: Analysis, Design, Development, Implementation, and Evaluation for non-visual impaired students, partial visual impaired students, and blind students on marketing course of Diploma program. The results showed that the developed CAL has been considered as a critical factor not only to improve the students’ conceptual learning progression but also promote positive satisfaction. This is because the instruction reminds the students (readers) what has been remembering and helps them learning together.

With the suggestions from the students to improve CAL for example using game-based learning, cleaning sound noise, embedding more multimedia, the enhanced CAL has been developing. The experiment with larger size of participants is going to be conducted as well. The successful of this study might be an alternative way for educators/ researchers/ practitioners to develop CAL for visual impaired students in which the CAL is used to improve their conceptual learning progression.

Acknowledgements

This study was supported in part by Rajamangala University of Technology Phra Nakhon, Bangkok, Thailand. Thank you Asst. Prof. Dr. Patcharin Panjaburee, Institute Innovative Learning, Mahidol University, Thailand for suggesting academic writing.

References

- Ager, A., & Aalykke, S. (2001). TASC: A microcomputer suport system for persons with conitive disabilities. *British Journal of Education Technology*, 32(2), 373-377.
- Barak, M., & Ziv, S. (2013). Wandering: A Web-based platform for the creation of location-based interactive learning objects. *Computers & Education*, 62, 159–170.
- Basturk, R. (2005). The Effectiveness of Computer-Assisted Instruction in Teaching Introductory Statistics. *Educational Technology & Society*, 8(2), 170-178.
- Chang, K. E., Sung, Y. T., Chen, Y. L., & Huang, L. H. (2008). Learning multiplication through computer-assisted learning activities. *Computers in Human Behavior*, 24, 2904–2916.
- Chyung, S. Y., & Stepich, D. (2003). Applying the "Congruence" Principle of Bloom's Taxonomy to Designing Online Instruction. *The Quarterly Review of Distance Education*, 4(3), 317-330.
- Denny, M. (2003). The use of computer assisted technology to enhance student psychiatric nurses learning during a practice placement. *Nurse Education in Practice*, 3(2), 80–88
- Douglas, G. (2001). ICT, Education, and Visual Impairment. *British Journal of Education Technology*, 22(3), 353-164.
- Ecalte, J., Kleinsz, N., & Magnan, A. (2013). Computer-assisted learning in young poor readers:The effectof grapho-syllabic training on the development of word reading and reading comprehen. *Computers in Human Behavior*, 29, 1368–1376.
- Gaeta, M., Loia, V., Mangione, G. R., Orciuoli, F., Ritrovato, P., & Salerno, S. (2004). A methodology and an authoring tool for creating Complex Learning Objects to support interactive storytelling. *Computers in Human Behavior*, 31, 620–637.
- Gagne, R. M., Wager, W. W., Golas, K., & Keller, J. M. (1992). *Principles of Instructional Design*: HBJ College Publishers.
- Hake, R. R. (1997). Interactive-engagement versus traditional methods: A six-thousand-student survey of mechanics test data for introductory physics courses. *American Journal of Physics*, 61(1), 64-74.
- Hake, R. R. (2002). *Relationship of Individual Student Normalized Learning Gains in Mechanics with Gender, High-School Physics, and Pretest Scores on Mathematics and Spatial Visualization*. Paper presented at the Physics Education Research Conference.
- Liu, T. C. (2010). Developing Simulation-based Computer Assisted Learning to Correct Students' Statistical Misconceptions based on Cognitive Conflict Theory, using "Correlation" as an Example. *Educational Technology & Society*, 13(2), 180–192.
- Melanie, M. (2008). Improving the flow of materials in a Cataloging Department: Using ADDIE for a project in the Ohio State University Libraries *Library Resources and Technical Services*, 52(2), 54-60.
- Ozdileka, Z., & Robeckb, E. (2009). Operational priorities of instructional designers analyzed within the steps of the Addie instructional design model. *Procedia Social and Behavioral Sciences*, 2046–2050.
- Pinhati, F., & Siqueira, S. W. M. (2014). Music students' behavior on using learning objects closer to the domain characteristics and the social reality. *Computers in Human Behavior*, 30, 760–770.
- Seo, Y. J., & Woo, H. (2010). The identification, implementation, and evaluation of critical user interface design features of computer-assisted instruction programs in mathematics for students with learning disabilities. *Computers & Education*, 55, 363–377.
- Shepherd, I. (2001). Providing Learning Support for Blind and Visually Impaired Students Undertaking Fieldwork and Related Activities. In P. Gravestock & M. Healey (Eds.). UK: *Geography Discipline Network*.

Learning Cinema Authoring System in the Classroom

Yuan-Fu LUO*, Wei-Chih LIN, Tai-Yin LIN, De-Yuan HUANG, Chi-Wen HUANG & Gwo-Dong CHEN

Department of Computer Science and Information Engineering, National Central University, Taiwan
*yuanfuluo@outlook.com

Abstract: Nowadays, it's more and more important to have authentic instruction which lets students interact with learning context and apply their knowledge into real life. In this research, we construct a learning cinema authoring system. Teachers may edit backgrounds, characters and dialogues to construct a situation which is based on teaching context. Moreover, students could have an opportunity to learn in an authentic situation. After experiment, we discover that the system could help teachers on preparing authentic learning material. Students also have better motivation when they learn in the authentic situation.

Keywords: Authentic learning, authoring tools, digital learning playground

1. Introduction

Teaching material is the medium of instruction between students and teachers, but the interaction between students and teachers is sometimes not enough. With the development of technology, teachers can bring multimedia to the class and offer more interesting educational materials. However, these teaching tools cannot provide a vivid situation in the classroom, and students cannot get immersed in those learning contents. Recently, many governments build English villages for students to learn foreign language and culture in a language immersion environment. However, building various scenes costs a significant amount of money and students rarely have an opportunity to learning in the English village and thus, we use existing facilities in the classroom (projector and projection screen) along with tablet and Kinect to build an immersive learning environment.

In this research, we construct an authoring system for situational teaching material. Teacher may use the system to meet the needs of individual students or classes and integrate with different teaching strategies. Moreover, the system helps teacher creates situational learning environment that is not only distinctive but also related to the content of textbook.

2. Related Work

2.1 Authentic Learning

Brown, Collins and Duguid (1989) considered that knowledge is developed through situation and activity. They also advocated that learners should learn in the real situations because the situation provides learner with practical experience which makes learning more concrete. Moore et al. (1994) thought that although authentic learning emphasizes the authenticity of learning activities. A learning activity is authentic if it is related to the real situation and is goal-oriented, for example, learning cooking. Moreover, Choi and Hannafin (1995) believe that the learning would be effective when the meaningful situational occurs. Lave and Wenger (1991) proposed the situated learning theory as a community of practice and considered that learning is fundamentally a social process. Learners need to learn through participating in communities of practice and creating relations between newcomers and old-timers. Based on situated learning theory, Herrington and Oliver (2012) proposed a real situation module.

According to researches above, it is necessary for learners to gain knowledge through participating in activities of real-life situation. Therefore, we construct a situational environment which help students apply knowledge flexibly in real life.

2.2 Authoring Tools for Teaching

Several researches constructed authoring tools for instruction.

Cloze (Hutchful, Matur, Cutrell, & Joshi, 2010) is an authoring tool for creating content for multiple mice applications. Based on the needs of teachers with low computer proficiency, Cloze simplified the editing process of digital learning materials. In this study, they concluded some design considerations of designing authoring tools for teachers with low computer proficiency: consider task-oriented interfaces, consider providing content primitives and incorporate pedagogy.

EasyAuthor (Chimalakonda & Nori, 2013) is an authoring tool for teacher to create and manage learning content for adult illiterates in India. The main goal of EasyAuthor is to support easy editing of teaching materials and integrate literacy learning methodologies at the same time.

These authoring tools cannot provide an easy editing environment for situational learning, and students can't immerse in these contents.

In addition, Murray (1999) concluded that an authoring tool has the following goals:

- Decrease the effort (time, cost, and/or resources) for making intelligent tutors.
- Decrease the skill threshold for building intelligent tutors
- Help the designer/author articulate or organize her domain or pedagogical knowledge.
- Support good design principles (in pedagogy, user interface, etc.).
- To enable rapid prototyping of designs.

2.3 Background of Digital Learning Playground

Wang et al. (2010) built an interactive learning stage called Digital Learning Playground (DLP) that turns learning content into an authentic, task-oriented learning scenario. They placed a robot as learning companion on the stage table. The robot let students pay attention to target knowledge. Then, JIANG, CHEN, WU, and LEE (2011) applied augmented reality (AR) code to flash cards as a tool to trigger virtual objects on the screen. They found that it was not easy to gather younger learners' attention. Kuan-Chang, Chia-Jung, and Gow-Dong (2011) applied board-game mechanics on the interactive whiteboard and presented situational scenarios on the screen. They conducted an experiment in a high school setting and observed that the effectiveness and engagement of learning outperformed than traditional classroom teaching. However, learners would take significance of time to explore and deal with problems in educational simulation like board game with authentic situations. In order to make instruction process more efficiently. Chen et al. (2013) utilized existing facilities in the classroom and content of textbook to construct an immersive learning environment. By integrating student's image into learning context and using body motion as a way of interaction, students can get immersed into teaching content.

Based on the accumulated experience from previous studies, we separated the scene in DLP into three elements: background, character, and dialogues. In addition, the interactive whiteboard is heavy and expensive, so we replace interactive whiteboard with tablet and build an authoring system which lets teacher design scenes as teaching contents.

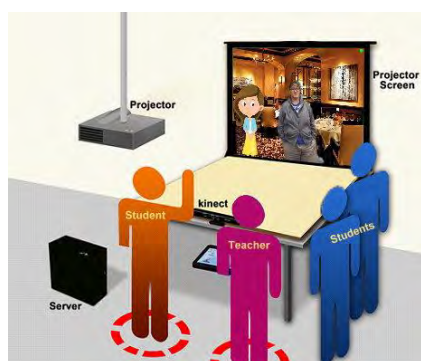

Figure 1. Device settings

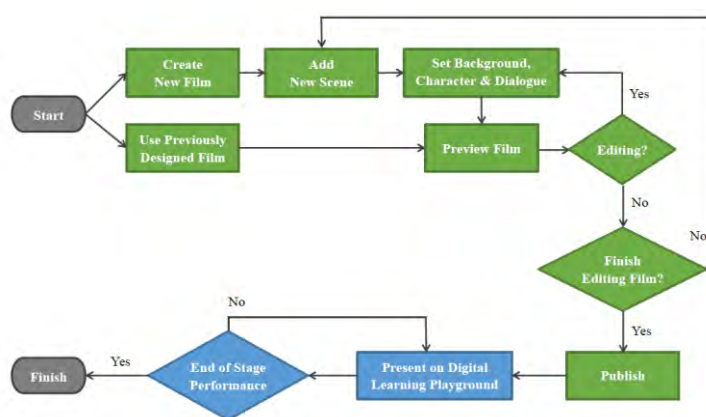

Figure 2. Procedure of Learning Cinema

3. System Design and Implementation

3.1 System Architecture

The settings of the system is shown in Figure 1. We construct a situational stage using projector, projection screen, Kinect and speaker. Projector presents situational scenes and virtual characters on the screen. Kinect captures student's body motion and integrates it into the scene. Speaker plays dialogues of the scene. Besides, the authoring tool on tablet is used as a manipulation tool of the stage.

3.2 Learning Cinema

The procedure of Learning Cinema is shown in Figure 2. The system lets teacher design situational teaching material for English or other language courses. Teacher may choose one of the scenario as teaching theme (such as ordering food in a restaurant). Next, teacher could design and arrange the scenes in the film. After editing, teacher presents situational teaching material through Digital Learning Playground (DLP) and allow students to have a stage performance. Students can practice listening and speaking skills on stage.



Figure 3. Setting background of the scene.



Figure 4. Previewing the scene.

3.2.1 Authoring Tool

In order to allow teacher who uses computer less often to make situational learning contents easily, we implement authoring system on the tablet. Teacher could create new film or edit previously created film. See Figure 3 as an example, each film is composed of multiple scenes, teacher may set background, character and dialogue of each scene. In addition to materials provided by system, teacher can shoot photos, searching pictures on the Internet or record dialogues then upload to material library for later use. Material library makes the content more diverse and allows teachers to design more flexibly. As shown in Figure 4, teacher could preview whole scene or film and make proper adjustment after editing. When all of the editing is done, the film is published to database.

3.2.2 Presentation

Film will present on DLP. Students may interact with the character and get immersed into the virtual scenes presented. Authoring system on the tablet is used as manipulation tool which enables teachers to switch between scenes and play dialogues of that scene to practice making conversations with students, and the subtitle of dialogues will display on the tablet when playing. Moreover, the system will record students' presentation on stage.

4. Experiment

We proposed the following two hypotheses:

- Students have better learning motivation when they are learning in authentic situation.
- Our system can help teachers to prepare and do authentic learning in the classroom.

4.1 Procedure

First experiment was held in one of the university in Taoyuan, Taiwan. Subjects were 12 university students who aged between 18 and 23. They were divided into 4 groups and there were 3 or 4 people in each group. In a 30-minutes experiment, we taught students some basic conversations in textbook and how to use our system. Then each group had a stage performance of situational film previously edited by teacher. After the presentation, students conducted an IMI questionnaire.

Second experiment was held in a primary school in Taichung, Taiwan. Subjects were 11 teachers who teach either English or Taiwanese. The experiment took about one hour. At first, we introduce the system and have a tutorial on it. Then, teachers would use our system to design teaching material for one of the situation. Next, teachers filled in a questionnaire edited by ourselves. At the end of experiment, we randomly chosen five teachers to conduct unstructured interviews.

4.2 Questionnaire

4.2.1 Intrinsic Motivation Inventory (IMI) Questionnaire

IMI questionnaire (Ryan, 1982) has seven subscales to measure participants' intrinsic motivation and self-regulation. We use the IMI Questionnaire to measure students' learning motivation. We choose four of seven subscales: Interest/Enjoyment, Effort/Importance, Pressure/Tension and Value/Usefulness. The participants had to rate each question by using the Likert seven-point scale, ranging from very true to not at all true (very true=7, not at all true=1).

4.2.2 Self-edited Questionnaire

The purpose of this questionnaire is to understand the mechanism and functions in this system via taking teachers' advice. The questionnaire have 8 questions, and the participants have to rate each question by using the Likert five-point scale, ranging from very true to not at all true (very true=5, not at all true=1).

5. Results and Discussion

5.1 Questionnaire

5.1.1 IMI Questionnaire

We use Cronbachs' alpha (α) coefficient to examine reliability of the questionnaire. As shown in Table 1, the reliabilities of subscales are over 0.7 except Interest/Enjoyment subscale, we speculate that all participants are college students who played many multimedia games and the situation provided by our system may not be exciting enough for them. The discussion of each subscale is presented below.

5.1.1.1. Interest/Enjoyment

This subscale investigating whether participants feel interesting and enjoyable in the situation. The higher score is better and the average score is 5.22. It represents that the participants feel pleasure when they do learning task. One participant said, "I am learning with the computer and I still think that it would be more interesting to learning with real people." We speculate that our system didn't provide learner to have body interaction with virtual character, so the participants may feel unreal.

5.1.1.2. Effort/Importance

This subscale figures out how much effort did participants put on learning. The higher score is better and the average score is 5.02. We observed that some participants mimicked the sound of the role and they tried their best to perform better in the situation.

5.1.1.3. Pressure/Tension

This subscale investigating how much pressure the participants feel in the situation. The lower score is better. We observed that some participants were shy when they were talking to virtual character. But the statistics show that participants who took learning activity before are less nervous. We speculate that it was their first time using our system and they have to speak loudly and present in front of other unfamiliar people so they would under pressure.

5.1.1.4. Value/Usefulness

The subscale finds out whether the contents that participants learn from the realistic situation are helpful or not. The higher score is better. According to the interview, most of the participants believed that the learning mechanism is very helpful. One of participant said, “It can practice speaking and listening which is very helpful for me.” On the other hand, some participants thought that the mechanism did not help for them. We speculate that participants are used to learning with textbooks and the mechanism provided by our system is unfamiliar for them.

Table 1: Reliability and average scores of IMI questionnaire.

Subscale	Cronbachs' alpha (α)	Mean	Standard Deviation
Interest/Enjoyment	.48	5.22	0.65
Effort/Importance	.86	5.02	1.07
Pressure/Tension	.94	2.87	1.24
Value/Usefulness	.89	4.79	0.94

5.1.2 Self-edited Questionnaire

The result of self-edited questionnaire is shown in Table 2. The average score is 4.43, it is a positive evaluation overall. And we discover that the score of question number 1 is 3.91. According to interview, some teachers had years of teaching experience and they didn't spend much time preparing teaching material. If they use our system, they would spend more time on preparation.

Table 2: Average scores of self-edited questionnaire.

	Question	Mean	Standard Deviation
1	Compare with traditional way, using this system would enable me to accomplish authentic learning material more quickly.	3.91	1.04
2	Compare with traditional way, using this system would assist me to accomplish authentic learning material better.	4.27	0.65
3	I can do more diverse teaching activity by using this system.	4.64	0.51
4	Templates provided by system can help me reduce time to prepare authentic learning material.	4.55	0.52
5	I'm glad to share my situations to other teacher.	4.73	0.47
6	It is very convenient to edit situation by tablet.	4.27	0.65
7	It is easy to control teaching process through tablet.	4.18	0.98
8	Integrating students' image into the situation would be more fun in teaching.	4.91	0.30
Total		4.43	0.51

5.2 Teacher Interview

5.2.1 Integrate Students' Image into Authentic Scenes

Some teachers believed that it can attract students at the first time. When they are familiar with this learning mechanism, they might lose interest. On the other hand, most of teachers thought that students will be very excited to see their classmate or themselves in the scenes at first, even disrupt the class. But they believed that it will be better after implemented few times.

5.2.2 Students Having Better Learning Motivation

Every teacher has his own way to attract students' attention and motivation. Most of teachers thought that the learning mechanism provide by our system is very attractive and let students have better motivation.

5.2.3 Editing and Reusing Teaching Material

Some teachers don't spend much time preparing teaching material before the class. They would spend more time if they use our system. Teachers said that if the system provide a large amount of templates, it may reduce time for preparation. Besides, most teachers are willing to share situation films to other teachers.

6. Conclusion

In this research, we provide a system which can help teachers to construct corresponding authentic situations and provide an opportunity for students to learn in an authentic situation. Students immersed in teaching content by integrating student's image into learning context. Teachers believed that the learning mechanism provided by our system will attract students' attention and have better learning motivation. Moreover, the system can help teachers on preparing authentic learning material. Results of IMI questionnaire show that students have better motivation when learning in the authentic situation. The teachers' opinions are consistent with students' questionnaire result. In addition, both of teachers and students thought our system not only can use in language learning but also can apply in scientific experiments, self-introduction or interview simulation.

Acknowledgements

We wish to express sincere thanks to the teachers at Chung-Hua Primary School and students at National Central University. This work is supported by the Ministry of Science and Technology, Taiwan, under the grant number MOST 103-2511-S-008-001-MY3.

References

- Brown, J.S., A. Collins, and P. Duguid, Situated cognition and the culture of learning. *Educational researcher*, 1989. 18(1): p. 32-42.
- Moore, J. L., Lin, X., Schwartz, D., Petrosino, A., Hickey, D. T., Campbell, O., & Hmelo, C. (1994). The relationship between situated cognition and anchored instruction: A response to Tripp. *Educational Technology*, 34(8), 28-32.
- Choi, J.-I. and M. Hannafin, Situated cognition and learning environments: Roles, structures, and implications for design. *Educational Technology Research and Development*, 1995. 43(2): p. 53-69.
- Lave, J. and E. Wenger, Situated learning: Legitimate peripheral participation. 1991: Cambridge university press.
- Miller, R., A Guide to Authentic E-learning—By Jan Herrington, Thomas C. Reeves, and Ron Oliver. *Teaching Theology & Religion*, 2012. 15(2): p. 202-203.
- Hutchful, D., Matur, A., Cutrell, E., & Joshi, A. (2010). Cloze: an authoring tool for teachers with low computer proficiency. Paper presented at the Proceedings of the 4th ACM/IEEE International Conference on Information and Communication Technologies and Development, London, United Kingdom.
- Chimalakonda, S., & Nori, K. V. (2013). EasyAuthor: supporting low computer proficiency teachers in the design of educational content for adult illiterates. Paper presented at the CHI '13 Extended Abstracts on Human Factors in Computing Systems, Paris, France.
- Murray, T. (1999). Authoring Intelligent Tutoring Systems: An Analysis of the State of the Art. *International Journal of Artificial Intelligence in Education*, 10, 98-129.
- Wang, C.-Y., et al., Constructing a Digital Authentic Learning Playground by a mixed reality platform and a robot, in Proceedings of the 18th International Conference on Computers in Education. 2010.
- Jiang, J.S., et al., Constructing a digital learning playground with augmented reality and flashcard, in Proceedings of the 19th International Conference on Computers in Education. 2011.
- Kuan-Chang, C., Chia-Jung, W., & Gow-Dong, C. A Digital Board Game Based Learning System for Authentic Learning. Paper presented at the 11th IEEE International Conference on Advanced Learning Technologies (ICALT), 2011.
- Chen, C.-F., et al., Classroom Group-directed Exploratory Learning through a Full-body Immersive Digital Learning Playground, in Immersive Education Initiative 2013.
- Ryan, R. M. (1982). Control and information in the intrapersonal sphere: An extension of cognitive evaluation theory. *Journal of personality and social psychology*, 43(3), 450.

Presentation Reconstruction Method for Peer Review Support in Presentation Rehearsal

Akihiro TANIKAWA^{a*}, Ryo OKAMOTO^a & Akihiro KASHIHARA^b

^a*Faculty of Science, Kochi University, Japan*

^b*Graduate School of Informatics and Engineering, The University of Electro-Communications, Japan*

*tanikawa@is.kochi-u.ac.jp

Abstract: We have proposed a computer assisted peer review in a presentation rehearsal. In order to help the peers review the presentation, it reproduces the presentation mainly with the information embedded in the visual slides. However, the presenter generally uses not only the slides but also oral explanations in the presentation to transfer his/her knowledge and opinions to the audiences. The reproduction is accordingly inadequate for the peer review due to the lack of the oral information. This paper discusses how to reproduce a presentation with the slide and oral information.

Keywords: presentation rehearsal, peer review, support system, slide contents, oral explanation

1. Introduction

Presentation is one of knowledge communication, in which a presenter generally transfers his/her knowledge and opinions. It is recently conducted by means of presentation software, such as “PowerPoint” or “Keynote”, on laptop computers. We have proposed a presentation rehearsal support system (Okamoto and Kashihara, 2007), and have developed and tested the system in these seven years.

Presentation rehearsal gives a presenter an opportunity to refine his/her knowledge with review comments obtained from the peers. However, it is not easy for the peers to make comments while listening to the presentation. To address this issue, we have proposed the “time-shifting method” in which the peers could make their comments after the presentation with the slide data and presentation movies etc. (Okamoto and Kashihara, 2007). In this method, the presentation is reproduced mainly with the information involved in the slide. However, the reproduction seems insufficient because it does not use the information included in oral explanations. In order to get the peers’ comments that are fruitful for improving the presentation, it is necessary to reproduce the oral information in addition to the slide information.

There are a lot of related works on methods for supporting presentation. Shibata, Kashihara and Hasegawa have proposed the method for creating the presentation slides with the semantic structure embedded in a presentation document (Shibata, Kashihara and Hasegawa, 2012). Noguchi et al. have also used presentations for educational materials of meta-learning (Noguchi et al., 2010). Berena et al. have developed a system for online presentations (Berena et al., 2010). However, these methods mainly use the slide information to reproduce the presentations, and have little concern about the oral explanations. The oral information is just recorded as video movies at the most.

In this paper, we propose a method of the presentation reproduction, which uses slide contents and oral explanations. We call it “Presentation Reconstruction Method”, in which the presentation is divided into slide contents and oral explanations and is then reconstructed by making the correspondence between the divided contents and explanations. In the following, let us describe the method, a tool for reconstructing the presentation, and case studies with the tool.

2. Issue of Review Support in Presentation Rehearsal

Presentation rehearsal is a kind of peer reviews, which helps the presenter to improve his/her presentation skill through the review work by the peers. The peer review also allows the presenter to be aware of an insufficiency or an incompleteness of his/her knowledge (Kashihara and Hasegawa, 2003). Thus, review comments from the peers are essential for the knowledge refinement.

In order to support the presentation rehearsal, we have developed a peer review client with visual-oriented annotation method (Okamoto, Watanabe and Kashihara, 2013), a back-review client for supporting a revise work of the presentation (Okamoto and Kashihara, 2012), and so on. The system can reduce cognitive load on review work and help the presenter to revise the contents of the presentation. The system also utilizes textual information in the slides to reproduce the presentation. Although it has just recorded the presenter's talk as video movies, it has not utilized the oral information for the presentation reproduction.

Through the test use of the system, we found that the system had difficulties in facilitating the peer review in the following two cases. The one was the case where the presenter gave supplemental explanation about the information that was not included in the slide. The other was the case where the information described in a slide was omitted in the oral explanation. The result of review comments from the peers accumulated in the system, in addition, suggests that 19% of the comments are related to oral explanations (Okamoto, Watanabe and Kashihara, 2013), which cannot be ignored for supporting the peer review.

In order to obtain instructive review comments from the peers, it is important to allow them to review the presentation appropriately with the information accumulated by the system. We accordingly attempt to use the oral explanations in addition to the slides to improve the previous approach for the presentation reproduction and try to. The issue addressed here is to reproduce the presentation with the slide information and the oral explanations adequately.

3. Reproduction of Presentation

The reason why oral explanations have not been utilized in our study is a technical difficulty of accumulation of the oral explanations as text data directly. In this study, at first, we had considered how to handle the contents of oral explanations.

3.1 Conversion of Oral Explanations to Text Data

Primarily, we focused on a voice recognition technology. Recently, services with the voice recognition, such as "Siri" and "Google Voice Search", become common. In a scene that is required real-time property like a presentation, it is ideal to use the voice recognition. Though, in the present technology, it is difficult to deal with continuous speech recognition. According to the experiment in Kawahara, the rate of the word recognition in a 90 minutes lecture in Japanese was 70% on average, and he reported that the modification of the recognized text was necessary to use as the captions (Kawahara, 2013). For this reason, it is not practical to utilize the voice recognition. Thus, we decided not to use the recognition method to convert oral explanations to text data.

Secondly, we focused on presenter notes. A presenter which has little experience in a presentation frequently writes a script in the presenter notes. A cost to convert the oral explanations may be reduced with a text in the presenter notes. Therefore, we tried to use the presenter notes. If the contents of the utterance which is not described in the presenter notes includes in the presentation, we convert it manually.

3.2 Method of Presentation Reproduction

Assuming that it is possible to convert oral explanations to text data as previously mentioned, we examine how to reproduce a presentation with two types of data. We focused on correspondences between oral explanations and slide contents. In general, a presenter makes a presentation projecting slides supplementary and explaining what he/she should to talk. Therefore, for example, in the case of reading slide contents, it is possible to link between the oral explanation and the certain point of the

slide contents. By revealing the correspondences between the slide contents and the oral explanations, the review work is supported in the following two points.

- Comprehension of a structure in a presentation
- Collective review both of the slide contents and the oral explanations

According to the above reasons, the load of the review work by peers should be reduced.

4. Presentation Reconstruction Method

Based on the discussion in chapter 3, we considered the specific method of the presentation reproduction. There are two processes, “dividing” and “combining”, for the reproduction. In the process of “dividing”, the slide contents and the oral explanations should be divided into certain grain size to make clear a target for linking. In the “combining” process, the divided contents, which were transferred to peers at the same time, are linked as appropriate. And, finally, linked contents are summarized into one combination as a presentation sequence. In this study, the above method of the reproduction is called “Presentation Reconstruction Method”. The schema diagram of the presentation reconstruction method is shown in Figure 1. The details of two processes are as follows.

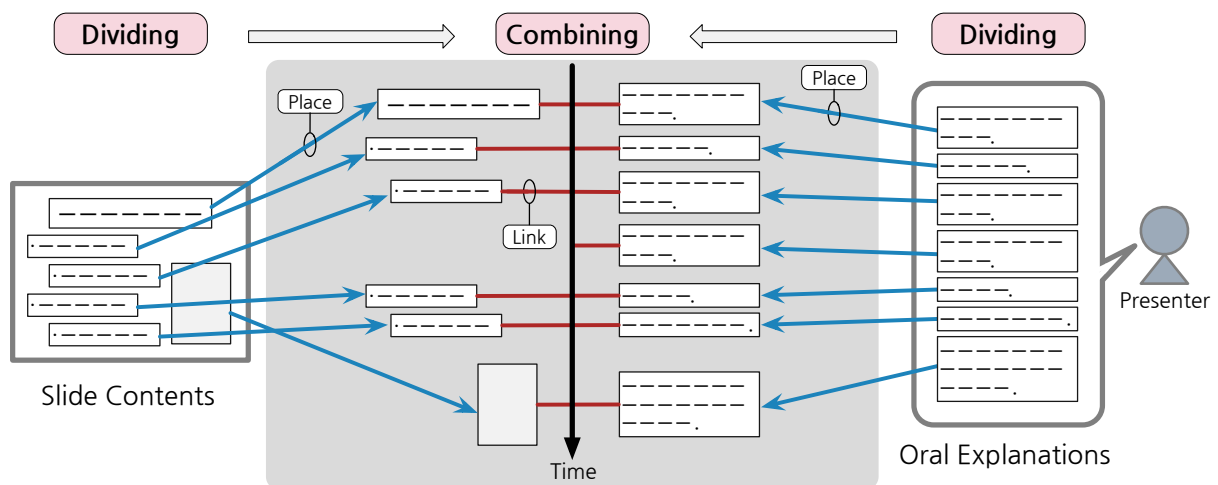

Figure 1. Schema of Presentation Reconstruction.

4.1 Dividing of Slide Contents and Oral Explanations

To elucidate how a presenter described in a certain slide, it is necessary not just to divide a presentation by slides but also to divide the slides adequately. We defined a means of the dividing as follows.

(1) Slide Contents

A slide is basically constructed of a title and a body part. Thus, the slide is divided these two. And, the body is constructed of texts, figures and tables. A text is generally described in the form of a bulleted list, and an item of the list is a smallest unit which has a set of a lexical meaning. Therefore, the texts are divided in each item of the lists. The figures and the tables are divided into some areas in an optional way. These divided slide contents are collectively called “slide elements”.

(2) Oral Explanations

At the time of dividing oral explanations, it is desirable to divide the explanations depending on a quantity of the slide’s text. Because an item of a bulleted list often corresponds to a sentence in the explanations, the explanations are divided into each of sentences. We collectively call these divided explanations “oral elements”.

4.2 Combining of Divided Elements

In the next step, the divided elements are combined. The following are procedures to combine the elements.

- (1) Place slide elements and oral elements separately in time-series order
- (2) Link slide elements and oral elements that are transferred at the same time

Actually, the presenter often explains about two or more items of the bulleted list in one sentence, or explains one list in several sentences on the contrary. In order to show a correspondence between slide elements and oral explanations clearly, it is desirable that each of elements has one-to-one correspondence. Therefore, in the former, the oral element is divided additionally, and the divided elements are linked to their respective slide elements. In the latter, the several oral elements are joined together, and the element is linked to a slide element.

5. Development of Presentation Reconstruction Tool

We have been developing a presentation reconstruction tool. The tool works on “Mac OS X”, and it supports “Keynote”. Presently, the tool is developed independent from the presentation rehearsal support system. An interface of the tool is shown in Figure 2.

The tool is equipped with an automatic dividing function to parse slides’ data and presenter notes in Keynote file. The function almost works well in dividing of bulleted lists and oral explanations. Each of divided elements is displayed on “slide view” or “oral explanation view”. The location of the each slide element in a slide is drawn in a red rectangle. The oral elements are displayed as a shape of a balloon and listed vertically in the right side of the window. At present, the view of the elements depends on the layout of slides, namely, the elements is not completely listed along time sequence. Thus, we are planning to change the design of the view.

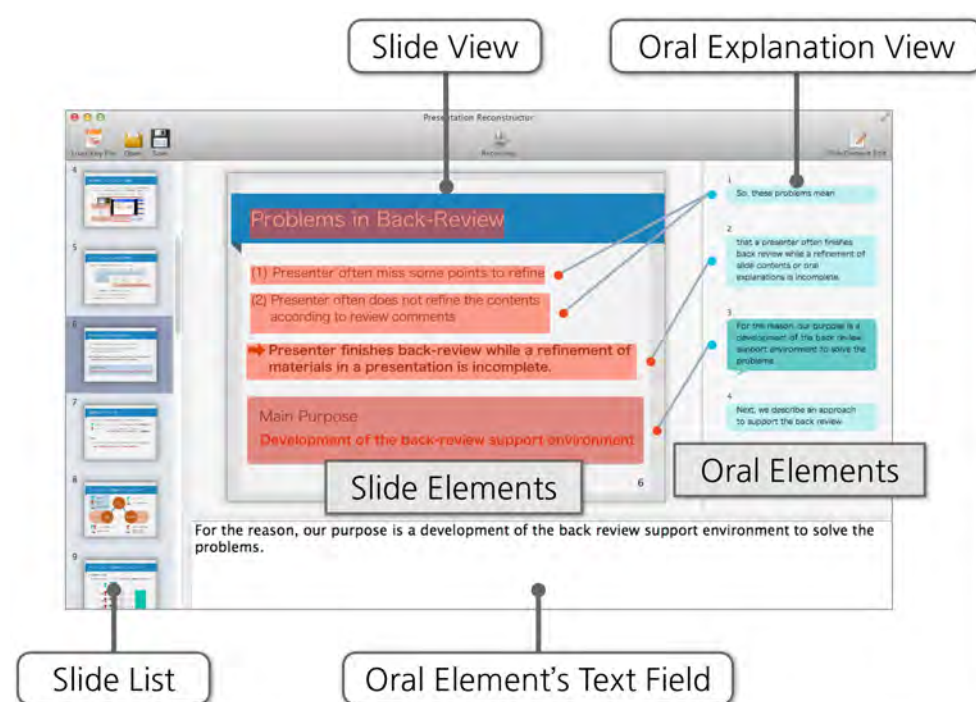

Figure 2. Interface of Presentation Reconstruction Tool.

After loading Keynote file, the elements are already displayed in a divided state. After that, a user performs following three types of works in sequence.

(1) Editing of Oral Elements

Because texts in presenter notes are different from each utterance in an actual presentation, the tool has a function of editing the oral explanation's text. The user selects an oral element in the "oral view", and adds, deletes or corrects the text of the element in the "oral element's text field".

(2) Additional Dividing of Slide Elements

The automatic dividing function for figures and tables are not supported at present. For this reason, the tool is equipped with a function to divide the figures or the tables into the slide elements manually. To divide the contents, the user can select a certain point where he/she wants to specify as a slide element with rectangle selection.

(3) Combining of Elements

The user makes a link between a slide element and an oral element to drag each other. A relation of the elements is drawn as a connected line.

6. Case Study

For the test use of the tool, we have reconstructed and analyzed six presentations which were accumulated by the presentation rehearsal support system. In this chapter, we introduce a case of the rehearsal for the presentation of a graduation thesis by an undergraduate student. Figure 3. shows parts of the reconstructed data in the presentation. An expression of this figure is modified from the data in the tool to make easy to see the relationship between the elements.

In the case A, a user can see the timing that these elements transferred and the amount of each oral explanation which is connected to the corresponding slide element. Also, the 7th oral element in the slide is not linked to any slide elements. It means that the element was transferred only by the utterance. In consequence, the reconstruction of the presentation shows the information that has not been visible so far.

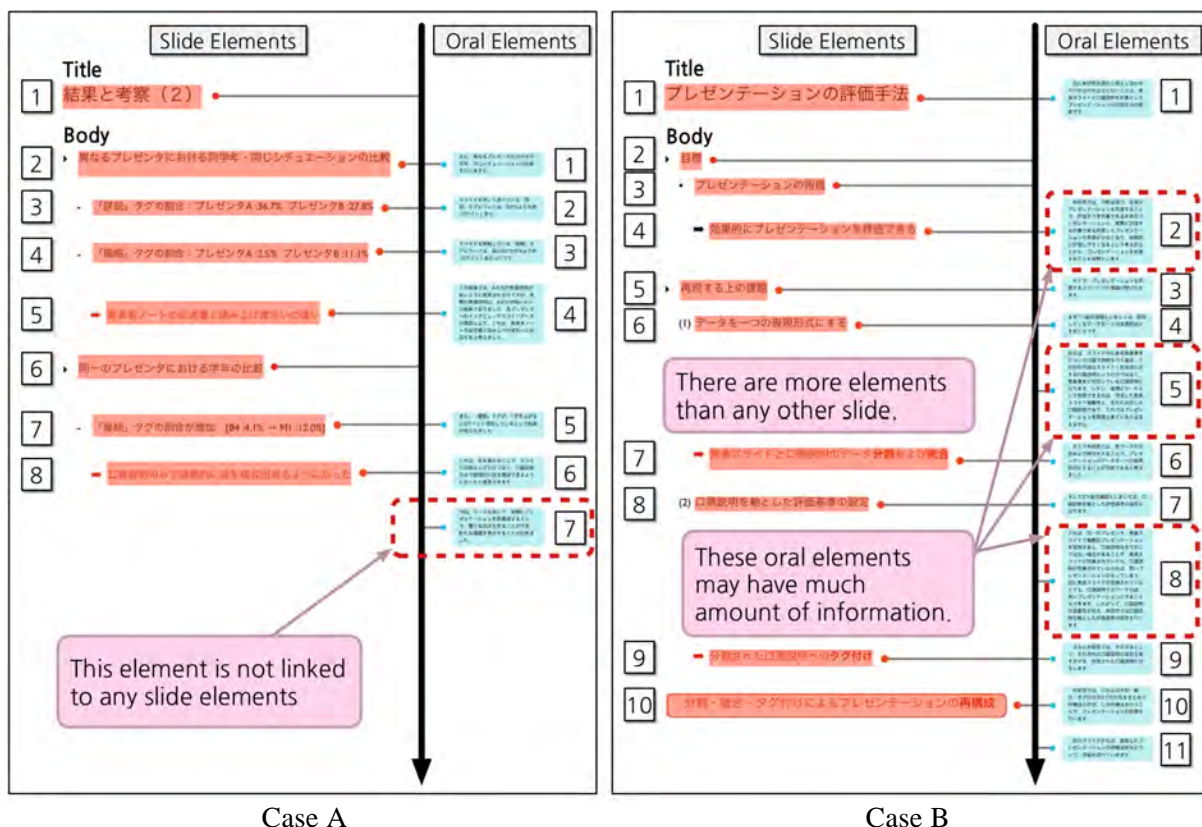

Figure 3. Relationship between Slide Elements and Oral Elements

Table 1: Aggregate Results of Elements in Presentation by Undergraduate Student.

	Number of slide elements	Number of oral elements
Case A	8	7
Case B	10	11
Average in all slides	6.0	5.9

In the case B, according to Table 1., the number of the elements in the slide is more than any other slide. Actually, in the rehearsal, a peer made a comment “*This slide has much amount of information. And also, there were too many contents explained only by the oral explanation. So, I didn’t comprehend the details.*” This means that the number of the elements substantiates a reason of the comment. There is a possibility to evaluate presentation by an aggregate of the elements because contents of slides and oral explanations are divided into elements by the reconstruction.

7. Conclusion

In this paper, we described a presentation reconstruction method by dividing and combining of slide contents and oral explanations for a presentation reproduction. And we developed the tool based on the consideration. Through the case studies, the tool almost works well. As our future work, we add the function of the tool into the presentation rehearsal support system, and conduct experiments with the system in actual rehearsals. As mentioned earlier, about this time, we used presenter notes to convert oral explanations to text data, and we manually converted the explanations which does not include in the notes. In the method, a user can confirm a presentation after the rehearsal. Though, the user cannot confirm the presentation instantly in the rehearsal. Therefore, it is required to further consider the method for the conversion of the explanations. Also, we would implement additional functions which are not implemented in the current tool yet.

Acknowledgements

This research is supported in part by Grant-in-Aid for Scientific Research (C) (No. 25350336) and (B) (No. 23300297) from Ministry of Education, Culture, Sports, Science and Technology of Japan.

References

- R. Okamoto, & A. Kashihara (2007). Presentation Review Supporting Environment with Realtime-created Hypervideo Technique. Proc. of International Conference on Computers in Education, 433-440.
- Y. Shibata, A. Kashihara, & S. Hasegawa (2012). Schema-based Scaffolding for Creating Presentation Documents, Proc. of the 20th International Conference on Computers in Education, 324-326.
- D. Noguchi, K. Seta, M. Fujiwara & M. Ikeda (2010). Presentation Based Learning Support System to Facilitate Meta-Learning Communications. Proc. of 18th International Conference on Computers in Education, 137-144.
- A. J. Berena, Z. He, P. Sriprasertsuk, S. Chu nwijitra, E. Okano & H. Ueno (2010). Shared Virtual Presentation Board for e-Communication on the WebELS Platform. Proc. of 18th International Conference on Computers in Education, 280-284.
- A. Kashihara & S. Hasegawa (2003). Learning Bench: A Self-Directed Learning Environment on the Web. Proc. of World Conference on Educational Multimedia, Hypermedia, & Telecommunications, 1032-1039.
- R. Okamoto, & A. Kashihara (2012). Back-review support system for presentation rehearsal review. International Journal of Knowledge and Web Intelligence 2012, 3(1), 45-57.
- R. Okamoto, Y. Watanabe, & A. Kashihara (2013). Review Support System with Visual-Oriented Annotation Method for Presentation Rehearsal. Proc. of the 21st International Conference on Computers in Education, 301-303.
- T. Kawahara, Captioning for Lectures Using Automatic Speech Recognition Technology (2012). The journal of the Institute of Image Information and Television Engineers, 66(8), 641-644.

Probabilistic Question Selection Approach for AR-based Inorganic Chemistry Learning Support System

Masaru OKAMOTO^{a*}, Ryoya SUMIDA^a & Yukihiro MATSUBARA^a
^aGraduate School of Information Sciences, Hiroshima City University, Japan
*okamoto@hiroshima-cu.ac.jp

Abstract: In this paper, we proposed AR-based learning support system using user's learning history information for inorganic chemistry with probabilistic question selection algorithm based on learner's operation in the virtual environment. In order to perform experiments in the virtual environment, markers and USB camera are utilized as input interface. By using this interface, a learner can perform the chemical experiments in the virtual environment. For chemical experiments, the proposed system gives some questions to a learner. These questions are selected based on a learner's learning history information. This selection algorithm helps a learner performing the experiments corresponding to suitable questions for his/her learning about inorganic chemistry. For selecting a set of questions, probabilistic question selection algorithm is proposed. By using this selection algorithm, a learner can learn repeatedly about inorganic chemistry in the virtual environment. The validity of the proposed system and algorithm was shown as experimental results of subject's learning result.

Keywords: Augmented Reality (AR), Experiment-based Learning, Selection of suitable Questions, Inorganic Chemistry, Probabilistic approach

1. Introduction

In Japanese high school, chemical education consists of 3 parts (theoretical chemistry, organic chemistry and inorganic chemistry). Particularly, it is important for learners to perform various chemical experiment in the classroom for learn chemical reaction. However, it is too difficult for learners to learn all knowledge about chemical reaction in one experiment. And it is impossible that all experiments are repeatedly performed until all students memorize all chemical reactions. In order to improve these problems, learning support systems using virtual experiment are developed (Konishi *et al.* (2010) and Nanko *et al.* (2008)).

On the other hand, it is important for learners to observe an experimental result (for example, colors) and process of experiments in Japanese high school education. Before now, in order to learning the inorganic chemistry based on virtual experiment, we developed AR-based learning support system (Sumida *et al.* (2012)). AR is helpful in order to make a natural user interface which integrated VR and real world (Asai *et al.* (2011), Iwasaki *et al.* (2010), Sano *et al.* (2010), Santos *et al.* (2014) and Okada *et al.* (2013)). In order to perform experiments in virtual environment, markers printed on papers are utilized as control interface. By user's operation of markers, user can perform various experiments (such as flame test). Additionally, so the system can give questions and hints, user acquires knowledge of chemical reaction by solving questions in virtual environment. However, for learning the knowledge of inorganic chemistry using only this AR-based learning support system, learners have to select some question about inorganic chemical reactions. Then we developed question recommendation method for this system (Okamoto *et al.* (2013)). By using this approach, it is expected that they can perform their learning process more effectively. However learner has to solve paper test to give the system some information about learner understands.

In this paper, we proposed probabilistic question selection method based on learner's operation in the virtual environment for AR-based learning support system. Given questions are probabilistically determined by learner's operation information. This information is calculated from user's operation in the virtual environment. By learning repeatedly using this system and given questions, it is expected that the learner can memorize all chemical reactions corresponding to prepared questions.

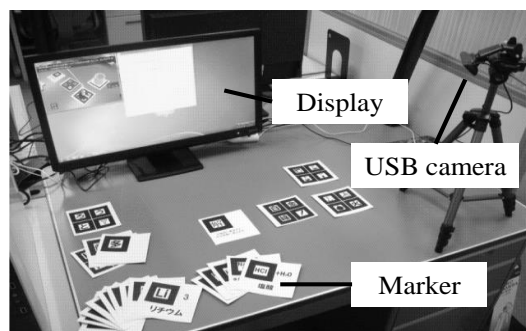

Figure 1: The Overview of the Proposed System.

2. 2. Inorganic chemistry learning management system using AR-based virtual laboratory

2.1 System Structure

Figure 1 shows the overview and structure of the proposed system respectively. As shown in Figure 1, this system has three devices (1: USB camera, 2: computer and display, 3: markers for input interface). USB camera records image of user's operation in order to create the virtual environment for experiments based on real image and CGs. Simulation of experiments and creation of virtual environment are carried out by computer. In order to construct the virtual laboratory from real image recorded by USB camera, user's operation must be recognized from real image. Then various markers are utilized for recognition of user's operation. By putting and moving markers in recorded area, user's operation are easily recognized by the system. For recognition of markers from image recorded by USB camera, ARToolKit library and markers are utilized. Table 1 shows examples of markers used in the virtual environment. By putting these marker in recorded area, this system understand that user utilize the corresponding instruments. Additionally corresponding CGs are displayed near the marker in virtual environment (shown in Figure 1). Then, solutes and water solutions have to be selected for performing experiments which user wants to conduct. The operation markers shown in Table 2 are used for showing user's intention of operation.

Table 1: Examples of Markers Corresponding to Instruments and Item for Experiment.

	Instruments	Solutes	Water solutions
An Example Image of Markers			

Table 2: Examples of Markers Corresponding to Operation by Learner.

	Operation for water solutions	Adjustment of Solutes' parameters	Checking learner's result of experiment as answer
An Example Image of Markers			

2.2 AR-based Virtual Environment with Giving Questions Function

In this system, in order to perform the chemical experiments, the virtual environment is utilized. By using this environment, learner can perform three chemical experiments (1: flame color test, 2: precipitation of ion, 3: positive ion analysis). The system understands the type of experiments which learner wants to conduct from the arrangement of the instruments markers. Next, an example of the virtual experiment is described.



(a) Preparation of water solution which contain ferric ion

(b) Adding the precipitating agent for making precipitation of ion

Figure 2: Example of Experimental Process about Precipitation of Ion.

An example precipitation of ion experiment is shown in Figure 2. In this experiment, user has to investigate the phenomenon about the color precipitation of ion, used precipitating agent and so on. In order to conduct this experiment in virtual environment, user should use the three kinds of marker (instruments marker, solutes marker and water solutions marker). In the example of experiment shown in Figure 2, at first, water solution that contains the ferric ion is prepared in beaker (Figure 2(a)). For this preparation, ferric ion marker is put and moved near the beaker marker. In next process, by adding the precipitating agent into the beaker, user can check the precipitation of ion. Then a water solution maker is put and moved near a beaker marker (Figure 2(b)). By this operation, corresponding water solution (hydrogen sulfide solution) is added into prepared solution in virtual environment. By conducting the experiment corresponding to phenomena which can indicate the information that user wants to know, user can learn about precipitation phenomena through the experiments.

2.3 Giving Questions Function

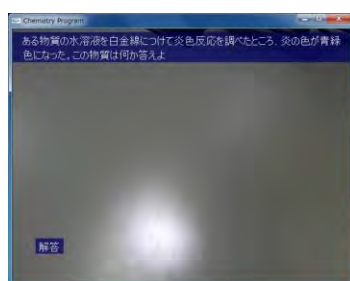

(a) An example of presentation of a question in virtual environment

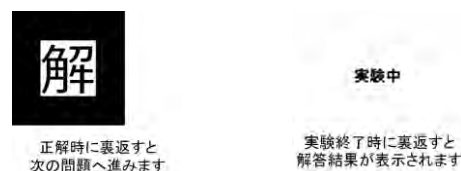

(checking the result of experiment)

(during experiment)

(b) Checking marker

Figure 3: Question and Marker for Checking Answer.

In this subsection, question-based learning approach is described. The question is displayed on the upper part of virtual environment. Figure 3(a) shows an example of presentation of question in virtual environment. In this question, “What is ion which can change the color of flame into blue-green?” is written in Japanese. When checking marker (Figure 3(b)) is turned, system

evaluates the answer (result of experiment). If user makes mistake, hint is displayed on the underside of virtual environment and user perform experiment again based on given hint. After having a correct answer, by turning this marker again, next question is given for user.

2.4 Probabilistic Questions Selecting Approach based on Learner's Process of Experiment

In the proposed system, a set of question is given to each learner for leaning the chemical reactions through answering process. To performing learning effectively, suitable questions have to be selected. By finding answers of given questions through experiments in the virtual environment, it is expected that the learner can acquire the knowledge corresponding to given questions. Questions selection algorithm is shown as below. Then, in this algorithm, the number of questions in one set is set as Q .

1. At first, parameters $V_1(l)$, $V_2(n)$, and $V_3(m)$ are initialized.
2. A learner performs experiment in the virtual environment for answering given questions.
3. After experiment, parameter $V_1(l)$ is calculated. If experimental process of each given questions is applied for some conditions, the corresponding weights are added to each parameter $V_1(l)$. The all conditions and corresponding weights are shown in Table 3.
4. The parameters $V_2(m)$ are calculated. Then m is a number of the question which is not applied to all conditions in Table 3. And the parameters $V_3(n)$ is determined, where m is question number which is not given once. Then, $V_2(m)$ and $V_3(n)$ are constant number. $V_2(n)$ is set as $\alpha V_3(n)$ ($0 < \alpha \leq 1$).
5. The parameters ($V_1(l)$, $V_2(m)$, $V_3(n)$) and the probabilities for all questions ($P_1(l)$, $P_2(m)$, $P_3(n)$) are calculated as follow equations.

$$\begin{aligned}
 V_1(l) &= \begin{cases} 0, & q = 0 \\ \sum_{d=1}^D W(d) \text{count}_d(l), & o.w. \end{cases} \\
 V_2(m) &= \begin{cases} \alpha, & q = 0 \\ \frac{\alpha(Q-q) \sum_{l \in L} V_1(l)}{q(\alpha \|\mathbf{M}\| + \|\mathbf{N}\|)}, & 0 < q < Q \\ 0, & o.w. \end{cases} \\
 V_3(n) &= \begin{cases} 1, & q = 0 \\ \frac{(Q-q) \sum_{l \in L} V_1(l)}{q(\alpha \|\mathbf{M}\| + \|\mathbf{N}\|)}, & 0 < q < Q \\ 0, & o.w. \end{cases} \\
 P_1(l) &= \begin{cases} 0, & q = 0 \\ \frac{V_1(l)}{V}, & o.w. \end{cases} \\
 P_2(m) &= \begin{cases} \frac{\alpha}{V}, & q = 0 \\ \frac{V_2(m)}{V}, & 0 < q < Q \\ 0, & o.w. \end{cases}
 \end{aligned}$$

$$P_3(n) = \begin{cases} \frac{1}{V}, & q = 0 \\ \frac{V_3(n)}{V}, & 0 < q < Q \\ 0, & o.w. \end{cases}$$

, where q is the number of questions selected from a set of the question applicable to the conditions of the Table 3. \mathbf{M} and \mathbf{N} are set of n and m respectively. Intersection of \mathbf{M} and \mathbf{N} is empty set. And V is calculated as follow equation.

$$V = \sum_{l \in L} V_1(l) + \sum_{m \in M} V_2(m) + \sum_{n \in N} V_3(n)$$

- Based on calculated probabilities $P_1(l)$, q questions are selected. And, $Q-q$ questions are selected based on Probabilities $P_2(m)$ and $P_3(n)$. In the next experiment, selected questions are given to learner in the virtual environment.

Table 3: Conditions and Corresponding Weights for Probabilistic Estimation.

Conditions	Weights(W(d))
Condition 1: The number of times of trial is larger than one.	W(1) = 6.8
Condition 2: Experiment time is 11.75 seconds longer than the average of other experiment time.	W(2) = 3.4
Condition 3: Answer time is 18.1 seconds longer than the average of other answer time.	W(3) = 5.0
Condition 4: The number of incorrect answer is larger than one.	W(4) = 7.8

3. Evaluation Experiment

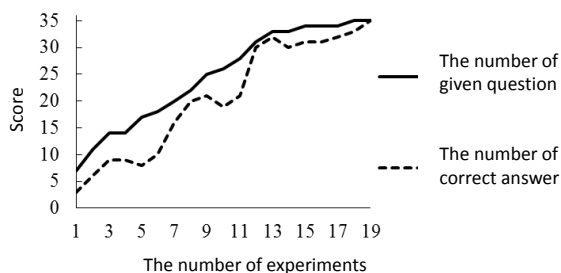

Figure 4: Experimental Results of Subject A in Paper Test.

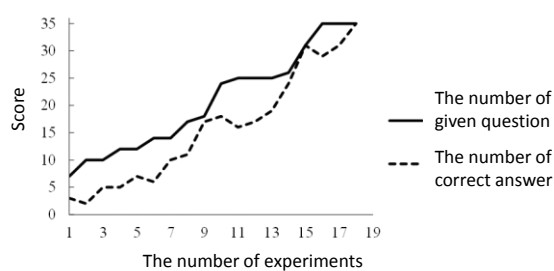

Figure 5: Experimental Results of Subject B in Paper Test.

In order to evaluate the effectiveness of proposed probabilistic selection of given questions and learning process using virtual environment, learning experiments about chemical reaction were conducted. Two subjects (A and B) participated in the experiments. Subject A learned about the knowledge of the chemical reaction using the proposed system. As a candidate for comparison, subject B used the previous systems (Okamoto (2013)). The previous system uses the paper test result of learner to determine the set of questions. And, Q was set as 7. The total number of given questions in this experiment is 35.

The results of the experiments of subject A is shown in Figure 4. For comparison, Subject A took paper test after each experiment. By learning repeatedly, in the 19th experiment, the subject A has acquired all the knowledge of chemical reactions corresponding to all questions given to subject A in the virtual environment. Next, to compare with a proposed system,

experimental result of Subject B is shown in Figure 5. As shown in this figure, the subject B's learning experiment is ended by 19 times too. The learning result of Subject B is similar to Subject A's result. However, total learning time of Subject B using the previous system is longer than Subject A's total time using the proposed system, because by using the proposed system, the questions are given to learner's without performing some paper test before each virtual experiments. From these results, by performing repeatedly learning using proposed questions selection algorithm and virtual environment, there is possibility that a learner can get all knowledge of inorganic chemical reaction which the Japanese high school students have to study.

4. Conclusions

This paper proposed probabilistic question selection approach based on a learner's learning history in the virtual environment. For chemical experiments, the proposed system gives some questions to a learner. These questions are probabilistically selected based on a learner's learning history information. The validity of the learning system based on proposed approach was shown as experimental results of 2 subjects' learning result. In future works, we would like to perform additional experiments to show the statistical analysis of proposed approach and system.

Acknowledgements

This work was partially supported by Grant-in-Aid for Young Scientists (B) No. 26750082 from MEXT Japan.

References

- Asai, K., Kondo, T., Kobayashi, H. & Sugimoto, Y. Y. (2011). Browsing Lunar Surface Using Tabletop Augmented Reality at Exhibit in Science Museum, *The Journal of Information and Systems in Education*, 10(1), 11-31.
- Iwasaki, Y., Nishimura, S., Hamada, Y. & Kozono, K. (2010). Development of the MR Laboratory for Electrical Experiment using ARToolKit, *Proceedings of 9th International Conference on Information Technology based Higher Education and Training*, (pp.125-128).
- Konishi, T., Okada, Y., Iizuka, D. & Itoh, Y. (2010) Development of an Intelligent Practice Supporting System for High School Chemistry, *Proceedings of the 18th International Conference on Computers in Education* (pp.66-70).
- Nanko, R., Okada, Y., Konishi, T. & Itoh, Y. (2008) Constructing Intelligent Virtual Laboratory for High School Chemistry to support learners' consideration, *Proceedings of the 16th International Conference on Computers in Education* (pp.105-109).
- Okada, M., Kawagoe, T., Soga, M. & Taki, H. (2013). Development of a skill learning environment for posture and motion with life-size bone model using augmented reality, *International Conference on Information Technology Based Higher Education and Training*, 1-8.
- Okamoto, M., Sumida, R. & Matsubara, Y. (2013) Inorganic Chemistry Learning Support System using AR-based Virtual Environment and Question Recommendation Method, *Proceedings of the Twelfth International Conference on Industrial Management* (pp. 411-417).
- Sano, A. (2010). A Web Application for Creating Real-Size Augmented Reality Content without 3D Modeling Skills, *The Journal of Information and Systems in Education*, 10(1), 32-38.
- Anderson, R. E. (1992). Social impacts of computing: Codes of professional ethics. *Social Science Computing Review*, 10(2), 453-469.
- Santos, M. E. C., Chen, A., Taketomi, T., Yamamoto, G., Miyazaki, J. & Kato, H. (2014). Augmented Reality Learning Experiences: Survey of Prototype Design and Evaluation, *IEEE Transactions on Learning Technologies*, 7(1), 38-56.
- Sumida, R., Okamoto, M. & Matsubara, Y. (2012). Framework of AR-based Virtual Environment for Inorganic Chemistry Learning, *Proceedings of the Eleventh International Conference on Industrial Management* (pp. 264-268).

The effect of discourse analysis activity with KBDeX on students' understanding about collaborative learning

Sayaka TOHYAMA^{a*}, Yoshiaki MATSUZAWA^b & Hajime, SHIROUZU^c

^a*Technical Division, Shizuoka University, Japan*

^b*Graduate School of Informatics, Shizuoka University, Japan*

^c*National Institute for Educational Policy Research, Japan*

*tohyama@inf.shizuoka.ac.jp

Abstract: (350 words) It is known that collaborative learning enhances deepening participants' understanding because there are iterative processes of questioning and answering about subjects. One person finds incomplete points and asks questions about his/her partner's explanation, and the asked person answers the questions. Although such iterative processes improve deepening understanding, Japanese first-year undergraduates typically divide tasks among group members and have little discussion. It suggests that students have difficulty to recognize the effect of collaboration because its processes are complicated. We provided following ones to the students to help analysis of constructive interaction: a simple discourse data of constructive interaction, discourse analysis support tool called KBDeX, and DASK which suggests the important points when analyzing constructive interaction. Students in 2013 "Learning Management" class studied the effect of collaborative learning through discourse analysis activity of constructive interaction. On the other hand, students in 2012 class only learn theories about the effect of constructive interaction from texts. The students in the 2013 class compared with the 2012 class using design research. We analyzed the students' beliefs about collaborative learning using their reports. 38 reports in the 2013 and 41 reports in the 2012 were analyzed. The result is that the students of 2013 changed their beliefs from "dividing tasks" to "exchange one's own thinking" than the students in the 2012 class. KBDeX and DASK supported finding characteristics of constructive interaction.

Keywords: KBDeX, Discourse Analysis, Constructive Interaction, Deep understanding.

1. Introduction

Students have been expected to have the skill of deepening their understanding in recent years, and the skill is claimed to be one of the important "21st-century skills" (Griffin, McGaw and Care, 2012) for creating an innovative future society, but it is not easy. We focused on the mechanism of "constructive interaction" (Miyake, 1986) as a way of deepening one's understanding in collaborative learning. When a student gives his/her opinion to his/her collaborator, the collaborator may ask questions about the student's incomplete opinion. The student rethinks his/her opinion and answer the collaborator. The processes of questioning and answering will continue iteratively through exchanging questioner and answerer. Such interactions enhance each participant's deepening understanding of the subject, not lead convergence of understanding (Miyake & Miyake, 2014). This effect of constructive interaction is shown in many learning situations (CoREF, 2013), but first-year undergraduates think that a group activity consists of dividing tasks among group members with little discussion, even when they had experienced group activities before entering the university (Matsuzawa, Tohyama and Sakai, 2013). We think that students miss numerous opportunities for deepening understanding because they do not know the relationship between collaborative learning and deepening understanding. However, if we lecture the students on the relationship between collaborative learning and deepening understanding, the students tend to forget it in the future because this type of knowledge is easy to disappear (Clement, 1987). We can observe the mechanism of constructive interaction when we analyze discourses from meta point of view (Tohyama, 2013). Thus, we provided KBDeX (Knowledge Building Discourse

eXplorer) and DASK (Discourse Analysis Sheets for KBDeX) to help students' own discourse analysis activity for understanding the characteristics of constructive interaction. We analyzed the students' beliefs about collaborative learning in the 2012 class and the 2013 class, focusing on changes in the Learning Management class curricula using design research (Brown, 1992).

2. Experiment Design

Our target was first-year undergraduates who studied "Learning Management" which held in 2013 at Japanese University during the autumn term as required classes. The students were expected to learn how to reflect their own study processes from meta points of view. In this study, we targeted the initial phase of the Learning Management because the students learn about merits of group work. The classes were also held in 2012 with the same form, and the 2013 class was the experiment group in this study. There were about fifty students in the 2012 class and the 2013 class. These students had their own laptop computers that were connected to the Internet. The second author was a class teacher, and the first author assisted him in both classes.

The activity for learning the merits of collaborative learning in the 2013 class differed from that in the 2012 class. We asked the students in the 2013 class to analyze a discourse of constructive interaction using KBDeX and DASK. The students in 2013 installed KBDeX on their own laptops along with sample discourse about a bobbin's rotation mechanism recorded by Yamanaka (2002). This bobbin problem looks simple but difficult to explain correctly. In the discourse, two master course's students discuss about the mechanism of a bobbin's rotation when its string is pulled (Figure 1). At first, their understanding levels of bobbin's mechanism were level 1 and 2, but at the end, both of them reached level 3 (highest) of understanding. The discourse was made by 235 lines. Each line was separated by the speakers' pause. The discourse could read on KBDeX, but we provide printed version to the students for improving its readability.

To emphasize characteristics of constructive interaction, twenty-seven keywords which were selected by the authors were loaded into KBDeX. These keywords were deeply concerned with the changing levels of understanding of two speakers. And we provided DASK to describe characteristics of each phase of the discourse using KBDeX. The discourse was separated into 11 phases based on the change in the speakers' levels of understanding, and KBDeX draw each phase of graphs.

The centers of two circular frames are interconnected by an axle, and a string is wound round it as illustrated in the figure. What will happen if you pull the string as shown below? The discs may roll, but never slide.

Mark the number that you think correct.

- (1) The bobbin rolls to the left.
- (2) The bobbin rolls to the right.
- (3) The bobbin does not move.
- (4) Others. (Write down your answer concretely.)

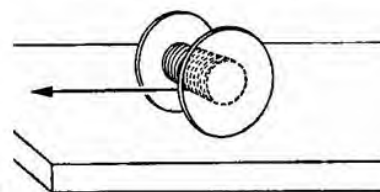

Figure 1. Bobbin problem.

On the other hand, we produced a collaborative text comprehension activity called "Jigsaw" (Aronson, 1978) for the 2012 class. In the jigsaw, the students were divided into four groups and provided one of four texts. Each text concerned the effects of collaborative knowledge building from the viewpoint of 21st-century skills (ITL Research, 2013). The students read the text within each group. After that, the students from each group made new groups and explained the texts to each other.

We provided "introduction activity" to both the 2012 and the 2013 classes before the jigsaw or discourse analysis. The activity was called "Collaborative Figure Description Building" (CFDB) (Araki *et al.*, 2008) and its reflection. The objective of CFDB and its reflection is to present the students a variety of ways of understanding clearly; this diversity of understanding contributes to the creation of new ideas and to using KBDeX. It took 180 minutes for the activities in 2012 and 2013. We also provided "wrap-up activity" to both the classes; a jigsaw activity using four texts for learning how to make collaborative learning more effective. The four texts were the mechanism of constructive interaction, functional fixedness in collaborative problem solving, nursery kids' collaborative learning,

and the conformity experiment. After the jigsaw is over, we expected the students to gain skills of building an effective collaborative learning environment.

The target activities - jigsaw or discourse analysis -, introduction activity, and wrap-up activity were shown in figure 2. The target activity in the 2012 class took about 90 minutes, while the 2013 class took 120 minutes because the students solve the bobbin problem before the discourse analysis activity in 2013. Needless to say, there were a lot of differences between the 2012 class and the 2013 class about target activity, so we regards a difference of post-reports between 2012 and 2013 as summative data and show the results of detailed analysis in 2013 as the effect of discourse analysis activity.

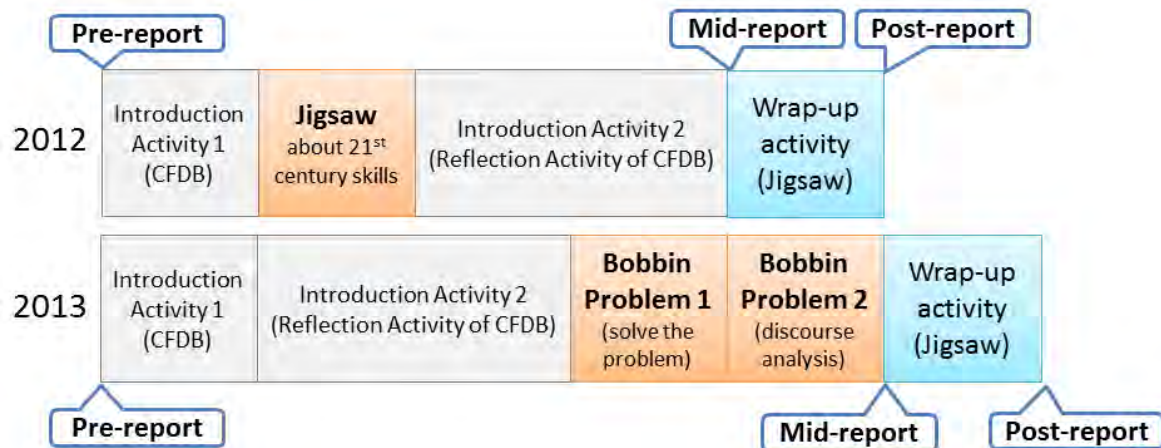

Figure 2. Activities in the 2012 and the 2013 classes.

3. Support Tools

KBDeX supports discourse analysis in collaborative learning from the perspective of complex network science (Oshima, Oshima and Matsuzawa, 2012) by visualizing network structures of discourse based on a bipartite graph of words × discourse units (e.g., conversation turns or sentences). The network structures are: (1) the speakers' network structure, (2) the unit network structure, and (3) the network structure of the target words (Figure. 3). We input discourse data (in .csv format) and a list of target words for bipartite graph creation (a text file). If we click a speaker in (1), KBDeX will mark units using red color in (2) and words in (3) which were referred by the selected speaker. Red nodes in figure 3

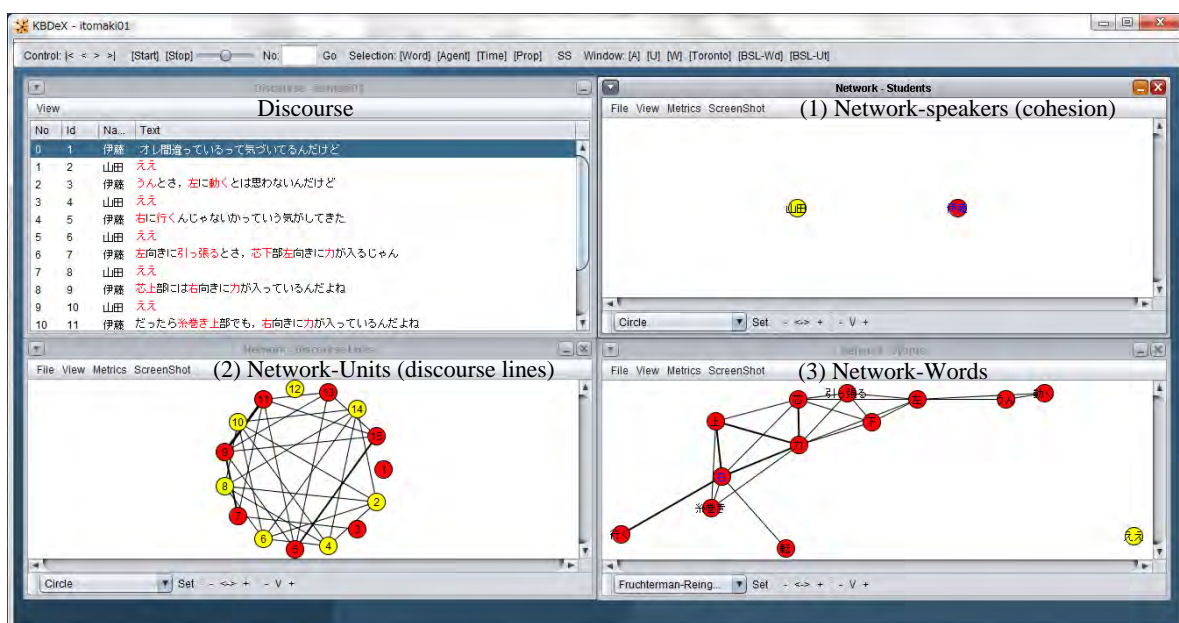

Figure 3. KBDeX Software Interface.

show units and words referred by “Itoh”, and we could guess that Itoh is a main speaker of this phase.

DASK supports emphasizing characteristics of constructive interaction of the discourse. First, DASK provides a graph indicating the speakers’ understanding level of each phase (Figure. 4) which was analyzed by the first author. Second, DASK required the students to find the characteristics of each phase based on the appearance of target words, remarkable statements, and the degree of cohesion between the speakers (Table 1). The students picked up some words from target words which were frequently appeared in each phase. Remarkable statement which is pointed by Id number was also selected by the students. The students selected one of three options such as loose, medium and tight for the degree of cohesion.

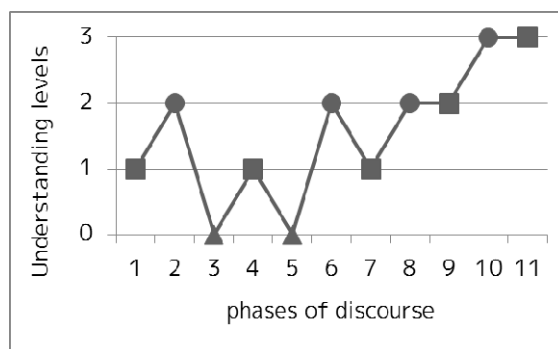

Figure 4. Graph of understanding level shown in DASK.
 (■: Speaker A, ●: Speaker B, ▲: Both speakers)

We categorized explanations of a phase which is based on simple rotation model (e.g. “If the bottom is pulled left, the top will move right.”) into level 1. Explanations of a phase which is based on incomplete model of “bottom’s axis” (e.g. “There is fulcrum point at the bottom of the axis, so if the bottom of the axis is pulled left the bobbin will be rotated to the left.”) into level 2. We categorized explanations which are based on complete axis model (e.g. “The axis is in the center of the bobbin, so wherever we pull the axis to the left, the bobbin will be rotated to the left.”) into level 3. Explanations not categorized into level 1, 2, or 3 were assigned to level 0.

Table 1. Worksheet for finding characteristics of discourse in DASK example.

Phase	frequently appearing target words	Selected Id # from the discourse	degree of association of the speakers	characteristics of the phase
(1)	<i>power, right</i>	Id: 9	loose medium tight	<i>Itoh's explanation</i>
(2)	<i>rotate, bottom</i>	Id: 30	loose medium tight	<i>Yamada's explanation</i>

4. Analyzing

We analyzed the three kinds of students’ reports and DASK which were written by the students in 2013. The students wrote reports at the initial phase, before the wrap-up jigsaw, and after the wrap-up jigsaw (Figure 3). The question in the pre-report was “what is the ideal group work for you?” and the question in the mid-report was “what will you do making your group work ideal?” We believe responses to these questions reflect the students’ thinking about what collaborative learning is. If the students wrote that externalizing their own thinking and revising it repeatedly in collaborative discussion is important, they may understand the relationship between collaborative learning and deepening understanding.

Students who gave us all the reports were selected as subjects. There were 38 such students in the 2012 class and 41 in the 2013 class. The first author as well as other staff members who worked at Japanese university analyzed these reports independently. The two results were 80% matched.

5. Results

5.1 Result 1: Students' thinking about what collaborative learning is

We categorized reports into “task dividing” or “exchange opinions.” Students who think of collaborative learning as task dividing were categorized into “task dividing.” Students who think that the importance of collaborative learning is exchanging one’s opinions were categorized into “exchange opinions.” The result of categorization of the 2012 class is presented in Figure 4, and the 2013 class’s result is seen in Figure 5. The number of mid-reports and post-reports in the “exchange opinions” category in the 2013 class was much higher than in the 2012 class even though the number of pre-reports in the 2012 class was almost the same as in the 2013 class. We checked the difference between the results of the pre- and mid-reports within each class using a chi-squared analysis. There was no significance in the 2012 class ($\chi^2=0.95$, $df=1$, $n.s.$), but it was significantly different in the 2013 class ($\chi^2=20.09$, $df=1$, $p<.01$). We also checked the difference between the results of the pre- and post-reports, there were significantly different both in the 2012 class ($\chi^2=6.08$, $df=1$, $p<.05$) and the 2013 class ($\chi^2=35.56$, $df=1$, $p<.01$). These results show that the discourse analysis activity helped the students’ learning about exchanging opinions is important in collaborative learning. The wrap-up activity was also effective in each class, but its effect was limited.

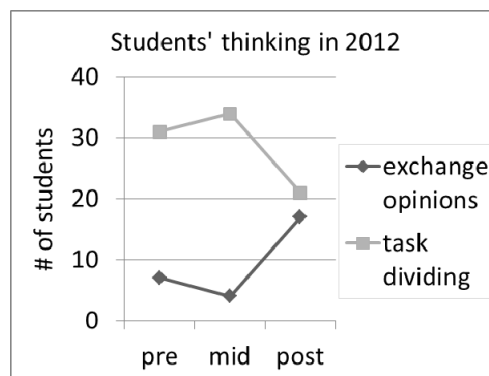

Figure 4. Students' thinking about collaborative learning in the 2012 class.

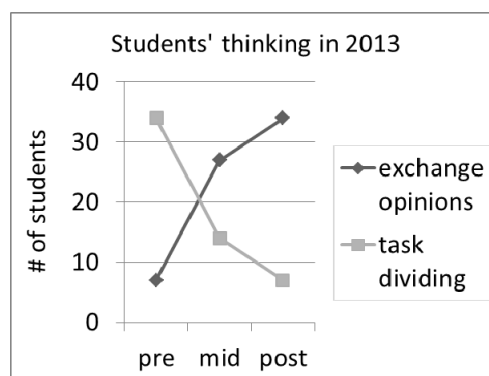

Figure 5. Students' thinking about collaborative learning in the 2013 class.

5.2 Result 2: Students' activities with DASK

We analyzed “characteristics of the phase” of written DASK to analyze the detailed activities of discourse analysis. Five students wrote that discussion is analyzed as a process that can lead to convergence of understanding. All of the five students wrote “task dividing” in the mid-reports. It suggests that the five students misunderstood the characteristics of constructive interaction. There was no significant difference about the frequently appeared words between the speaker A and the speaker B in each phase, but in detail, how to use the words were different each other. It seems KBDeX and DASK are limited to show the difference of detailed discourse. Moreover, two other students wrote that collaboration is iterations of questioning and answering. These two students also wrote “task dividing”

in the mid-reports. It is known that such iterations are important to improve deepening understanding in collaborative learning, but the two students only observed superficial form of discussion without a viewpoint of understanding level. These results suggest that KBDeX and DASK should show varieties of participants' understandings than ever.

6. Discussion

Students recognized that collaborative learning is effective as a deepening understanding activity through the discourse analysis activity using KBDeX and DASK, but the students who learned the characteristics of collaborative learning through text-based activity difficult to recognize this. The students who analyzed discourse with KBDeX and DASK noticed that externalizing their own thinking is necessary for deepening their own understanding because this is needed when they start a constructive interaction. These results suggest that students could change their beliefs when they are scaffold. KBDeX and DASK may help students overviewing of the process of collaborative interaction. However, these scaffolds were particularly ineffective because it misled some students to understand the characteristics of constructive interaction.

KBDeX is a powerful visualization tool, but how to interpret the characteristics of the graphs shown in KBDeX is not easy especially discourses are complicated like constructive interaction. We will continue to explore how to support qualitative analysis of discourses using KBDeX for finding more effective ways to the students.

This research is the first step in our plan. Our final goal is building the students' skills for collaborative learning which deepen the students' understanding. In the future, we hope to revise our Learning Management class with more appropriate use of KBDeX.

References

- Araki, M., Matsuzawa, Y., Sugiura, M. & Ohiwa, H. (2008). A proposal of "Describing Illustration with Language" for introduction education of programming. *Research report of JSET Conference in 2008 (3)*, 111-117. (in Japanese)
- Aronson, E. (1978). *The jigsaw classroom*. Beverly Hills, CA: SAGE Publications.
- Brown, A. L. (1992) Design experiments: Theoretical and methodological challenges in creating complex interventions in classroom settings. *The Journal of the Learning Sciences*, **2**(2), 141-178.
- Clement, J. (1987). Generation of spontaneous analogies by students solving science problems. In Topping, D., Crowell, D., and Kobayashi, V. (Eds.), *Thinking across cultures* (pp.303-308). Hillsdale, NJ: Lawrence Erlbaum Associates.
- CoREF (Consortium for Renovating Education of the Future) (2013). *Annual report 2013*. CoREF. (in Japanese)
- Griffin, P., McGaw, B. & Care, E. (2012). *Assessment and teaching of 21st century skills*. New York: Springer-Verlag.
- ITL Research (2013). *LEAP21: Learning Activities Coding Guide*. <http://www.itlresearch.com/>. (visited 2014/4/28)
- Matsuzawa, Y., Tohyama, S. & Sakai, S. (2013). The Course Design to Develop Meta-Cognitive Skills for Collaborative Learning through Tool-Assisted Discourse Analysis. *Collaborative Innovation Networks (COINs) 2013*, 2013.08. (<http://arxiv.org/abs/1308.1612>)
- Miyake, N. (1986). Constructive Interaction and the iterative process of understanding. *Cognitive Science*, **10**, 151-177.
- Miyake, Y. & Miyake, N. (2014). *Introduction to Educational Psychology*. Foundation for the promotion of the open university of Japan: Tokyo. (in Japanese)
- Oshima, J, Oshima, R. & Matsuzawa, Y. (2012). Knowledge Building Discourse Explorer: a social network analysis application for knowledge building discourse. *Educational Technology Research & Development*, **60**, 903-921.
- Tohyama, S. (2013). Scaffolding of Initial Understanding for Constructive Interaction : A Case Study of Collaborative Learning in Cognitive Science. *Cognitive Studies*, **20** (2), 177-203. (in Japanese)
- Yamanaka, Y. (2002). The elucidation: processes of understanding about solutions of "bobbin problem" by protocol analysis. The Bachelor's thesis of Chukyo University. (in Japanese)

The Impact of Using 3D Animation in Students' Spatial Ability

Jiong GUO^a, Yuhui MA^{b*} & He GAO^b

^a *Educational Technology College, Northwest Normal University, China*

^b *Education and Sports Science College, Bohai University, China*

*shixiaoran@163.com

Abstract: The purpose of this study is to investigate the impact of using animation in a multimedia environment designed to improve students' mathematical spatial ability. Sixth grade students (N = 44) were randomly assigned to one of the two experimental conditions with animation or non-animation as factors. The results show that participants provided with animations performed better than their peers provided with non-animations.

Keywords: spatial ability, 3D animation, multimedia environment

1. Introduction

Spatial ability is one of the most important abilities for many disciplines, such as mathematics, physics, chemistry, science et.al. But many students have difficulties in solving spatial problems. As multimedia technology rapidly develops, three-dimension technology has been introduced into the domain of education to help improving spatial ability. And many researches have proved that multimedia technology can improve students' performance if the design is rational. In recent years, many multimedia learning systems with three-dimension animations or software have been proved effective in improving students' spatial ability (Yeh, A, 2004; Hauptman, H. & Cohen, A, 2011; Hauptman, H, 2010; Christou, C., Pittalis, M., Mousoulides, N., & Jones, K., 2007).

Folding and unfolding problem solving is one of the spatial ability for students. It is a bridge between two-dimension figures and three-dimension figures. By solving folding and unfolding problems, students would know that polyhedron can be folded by two-dimension figures, and polyhedron can be unfolded into two-dimension figures in different ways. The traditional method in the classroom of teaching folding and unfolding in China is that students are asked to cut cube paper boxes or fold papers into cubes to perceive the process of folding and unfolding. Different students may cut the cube paper boxes in different ways, and that would produce different unfolding two-dimension figures. These different figures will be shown to the students as demonstrations. But the disadvantages of the traditional method are obvious. First, the paper boxes taken from home by students are not big enough to show to all students in the classroom. Second, paper boxes would not be reused when they are cut. So we developed the multimedia learning system to help solving folding and unfolding problems. In this system, 3D animations are contained to simulate transforming between 2D figures and 3D figures.

This study investigated the impact of 3D animations for students' solving folding and unfolding problems. We assumed that the students who received feedback with textual instruction and 3D animations would perform better than the students who received feedback without 3D animations. Furthermore, students' learning intrinsic motivation, cognitive load (including intrinsic load, extraneous load and germane load) are measured to investigate the effects of animation. A multimedia environment to learn folding and unfolding problem solving was developed to support this study.

2. Literature review

2.1 Spatial ability

Spatial ability is one of the most mathematical ability, and it has been defined as skill in “representing, transforming, generating, and recalling symbolic nonlinguistic information” (Linn & Petersen, 1985). But students have difficulties in solving spatial problems. A number of studies have proven that spatial abilities can be improved with appropriate exercise (Ben-Chaim, Lappan, & Houang, 1988), especially with learning by computers.

2.2 3D Animations in Spatial Education

Using 3D animation has been recognized as an effective method to improve students’ incomplete mental models (Wu & Shah, 2004, Ferk, Vrtacnik, Blejec, & Gril, 2003). So there have been some researches about applying 3D animation to improve students’ performance. Hauptman have developed a Virtual Spaces software environment to improve students’ spatial thinking (Hauptman, 2010). By learning with Virtual Space, students can exercise the abilities to build spatial images and to manipulate them. According to Hauptman, Virtual Spaces enhanced students’ spatial thinking.

Korakakis et.al. explored whether specific types of visualization (3D illustration, 3D animation, and interactive 3D animation) combined with narration and text contribute to students’ performance (Korakakis, Pavlatou, Palyvos & Spyrellis, 2009). And the results showed that multimedia applications with interactive 3D animations as well as with 3D animations increased the interest of students and make the material more appealing to students.

3. Method

3.1 Participants

Forty four sixth grade students (twenty three females and twenty one males) from elementary school in northeast China were invited to participate this experiment. Their average age was 11 years old, and they could operate computers and learn with computers. The participants were divided into two groups according to the class. There were twenty four students in the group of animation (experiment group), and twenty in the group of non-animation (control group).

3.2 Multimedia learning environment

The multimedia learning system was developed to improve students’ spatial ability. In this system, the animations that simulated two-dimension figure folded into a shape of cube or a cube unfolded into a two-dimension figure were included. Firstly, a folding or unfolding problem was presented, and then student submitted the answer. System would present “true” or “false” according to the students’ answers and some cues about the problem (i.e. “Think why this two-dimension figure can not be folded into a cube, and how to change this shape to be folded into a cube”). Then a static figure about the problem was presented. An animation would be played if the students of experiment group pressed the button of “folding”. These animations were developed with 3D MAX, it could simulate the process how and whether the two-dimensional figure folded the cube, or not. A sample segment of animations with hints is shown as Fig.1. The animation would not be presented if students were assigned to non-animation group. There were fifteen items with corresponding animations in this multimedia learning environment.

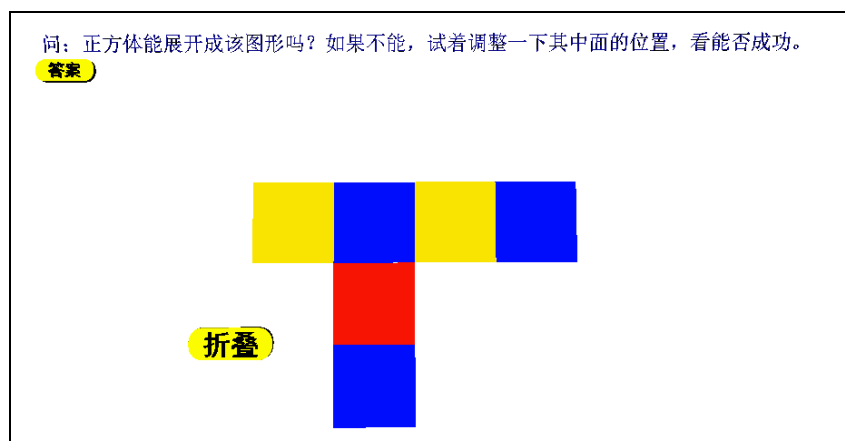

Figure 1. A sample segment of animations with hints.

3.3 Measures and instruments

A pretest and a posttest were developed to evaluate the learning effectiveness of the students. A pretest was composed of six choice items and fill-in-the-blank items about folding and unfolding cubes to measure participants' prior knowledge about spatial ability. Each of questions was 2 points, and the total points in the pretest was 12. The pretest aimed to detect that the two groups had the equivalent spatial ability. A posttest was conducted to measure the effect of participants' solving folding and unfolding questions after instruction. The posttest was composed of ten choice items and ten fill-in-the-blank items, which is different from pretest, but the level of the difficulty was similar. The total points in the posttest was 20. The sample question of the posttest is followed as Fig.2.

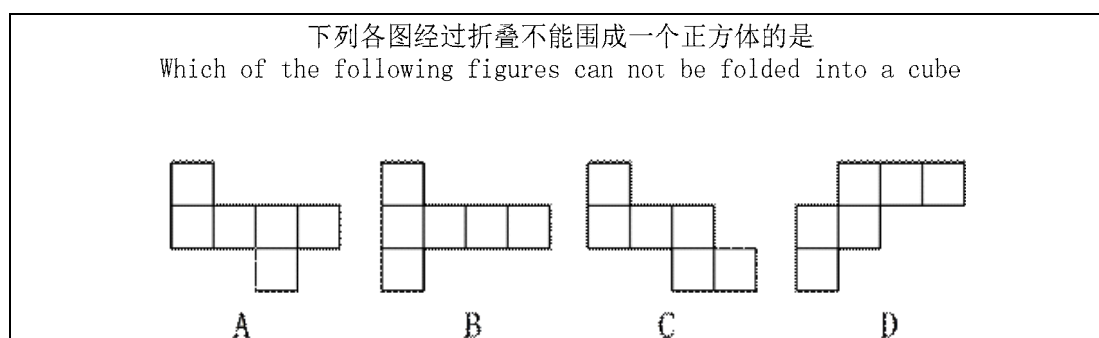

Figure 2. A sample question of the posttest.

In addition, a questionnaire with Likert-5-point was designed to measure students' intrinsic motivation. "1" was labeled as "not at all true", and "5" was labeled as "very true". There were total 10 statements, adapted from Ryan's study (Ryan, 1982), measuring intrinsic motivation with five subscales—interest, competence, pressure, value and effort (see Table 1).

Table 1: Intrinsic motivation items.

Item	Subscale
1. I spent a lot of effort to do this activity.	Effort
2. I feel these problems interest.	Interest
3. I think I was suitable to learn with this system	Competence
4. It was useful to study folding and unfolding problems.	Value
5. I didn't try very hard to do well at this activity.	Effort
6. I didn't feel nervous during learning.	Pressure
7. It was useful for me to learn these content.	Value
8. I was afraid to not do well at this activity	Pressure
9. I thought it was boring to do this activity.	Interest
10. I was not content with what I did at this activity.	Competence

Furthermore, a questionnaire with Likert-5-point was designed to measure students' cognitive load. "1" was labeled as "not at all true", and "5" was labeled as "very true". Three items about cognitive load (i.e., intrinsic load, extrinsic load and germane load) was conducted to measure the students' cognitive load (see Table 2). There were three statements to measure students' cognitive load adapted from NASA-TLX(Hart & Staveland, 1988) and were described in studies conducted by Gerjets, Scheiter, and Catrambone (2004).

Table 2: Cognitive measurement.

Item	Indication of
1. I thought these problems were very difficult.	Intrinsic load
2. I thought this system was helpful to learn these problems.	Extraneous load
3. I spent lots of effort to do this activity	Germane load

3.4 Procedure

The experiment was conducted in a laboratory setting. At the beginning of the experiment, a pretest with paper-and-pencil was made in order to measure whether the two groups had the similar level of spatial skill. Then students studied with the multimedia learning system in thirty minutes. Post-test was conducted to measure the effect of the spatial skill with animations or non-animations after instruction. Finally, the questionnaire was followed.

4. Results

4.1 Prior knowledge

The mean and standard deviation of the pretest were 9.12 and 1.45 for the experimental group, and 8.75 and 2.21 for the control group. An independent-samples *t*-test was conducted in order to examine whether animation group and non-animation group had different prior knowledge of spatial skill. The results revealed that there was no significant difference between the two groups ($t = .673, p = .505$), indicating that the participants in experimental group and control group had the equivalent abilities before learning.

4.2 Learning outcomes

An analysis of covariance (ANCOVA) was conducted to evaluate the effects of animation on students' performance. The percentage correct score on the pretest was used as a covariate. The result revealed a significant difference between the animation conditions and non-animation conditions ($F = 17.81, p < .01$), as shown in Table 3. The mean score of the experimental group is 15.82, higher than of the control group, 13.06. Furthermore, the effect size was computed to measure the strength of the *t*-test result. The *d* value 1 implied that the animation is very helpful to improve students' learning achievements.

Table 3: Descriptive data and ANCOVA of the posttest results.

Variable	N	Mean	S.D.	Std. error.	<i>F</i> value	<i>d</i>
Posttest						
Experimental group	24	15.82	1.92	.44	17.81	1
Control group	20	13.06	2.49	.48		

4.3 Intrinsic motivation

There were two items of each subscales of intrinsic motivation. So we add these two items of the subscale (effort, pressure, interest, value and competence) to compare students' intrinsic motivation of the two groups. *T*-test was conducted, and the results shows that the subscale of effort, pressure, interest

and value had no significant difference between the two groups. But “competence” had significant difference between the two groups ($t = .35$) (See Table 4). That is, the animations improved students’ competence of solving folding and unfolding problems.

Table 4: The t-test result of the post-questionnaire scores of the two groups.

Dimension	Group	N	Mean	S.D.	<i>T</i>
Effort	Experiment group	24	7.38	1.93	1.57
	Control group	20	6.40	2.19	
Pressure	Experiment group	24	5.96	1.27	.28
	Control group	20	5.85	1.27	
Interest	Experiment group	24	8.25	1.91	.24
	Control group	20	8.10	2.27	
Value	Experiment group	24	7.79	2.23	1.05
	Control group	20	7.10	2.12	
Competence	Experiment group	24	7.83	2.55	.35*
	Control group	20	7.60	1.85	

* $p < .05$

4.4 Cognitive load

Three ANCOVAs were conducted to evaluate the effects of animation on learners’ intrinsic load, extraneous load and germane load respectively. The covariate was pretest score so that participants’ prior knowledge was statistically controlled. There were no significant difference between the two groups with respect to intrinsic load ($F = .44, p > .05$), extraneous load ($F = .22, p > .05$) and germane load ($F = .45, p > .05$).

Furthermore, correlation analysis were conducted to measure the strength of relationship between intrinsic load or intrinsic motivation and difference between posttest scores and pretest scores. We assume that students’ intrinsic motivation and cognitive load would impact the posttest scores. The results show that intrinsic load ($r = -.365, p < .05$) and interest of intrinsic motivation ($r = -.415, p < .05$) relate to difference between posttest scores and pretest scores. So a univariate ANCOVA was conducted to measure the effect of intrinsic load and interest on the difference between posttest scores and pretest scores. The covariate was interest and the difference between posttest scores and pretest scores. The result is $F(1,43) = 3.20, p = .08, \text{Partial Eta Squared} = .078$. That means the significant difference between experimental group and control group is related to animations, but not to interest to mathematics and intrinsic load.

5. Discussion

The purpose of this paper is to explore the effect of 3D animations which simulating the transforming process between two-dimension figures and three-dimension figures on students’ performance of solving folding and unfolding problems. According to previous studies, 3D animation have been recognized as effective method to improve students’ spatial ability.

In this study, a multimedia system with 3D animations is developed. Students solve folding and unfolding problems in this system, and they can get feedback immediately with 3D animation or not. These 3D animations simulate the transforming process between two-dimension figures and three-dimension figures. In order to eliminate the factors that may influence the folding and unfolding scores, the two group students’ level of intrinsic motivation and cognitive load have measure by the questionnaire. The results show that the posttest score significant difference between the experimental group and control group is due to watching animation or not. This study proves that 3D animation is

helpful to students in improving students' ability of spatial image about transforming between two-dimension figures and three-dimension figures.

Furthermore, there are some limitations in this study. The sample size is small, this directly leads to some results un-significant. The result may be kind of different if the sample size is large enough.

Acknowledgements

We would like to thank Xiaopeng Guo, Chunna Zhou, Cong Chen, Yousong Guo and Taizhi Zhang for developing this multimedia system. This study is supported by Chinese Special Issue of Primary and Second School Mathematical Education GIA117015.

References

- Ben-Chaim, D., Lappan, G., & Houang, R. T. (1988). The effect of instruction on spatial visualization skills of middle school boys and girls. *American Educational Research Journal*, 25, 51–71.
- Christou, C., Pittalis, M., Mousoulides, N., & Jones, K. (2007). Developing the 3DMath Dynamic Geometry Software: Theoretical Perspectives on Design. *International Journal for Technology in Mathematics Education*, 13(4), 168-174.
- Ferk, V., Vrtacnik, M., Blejec, A., & Gril, A. (2003). Students' understanding of molecular structure representations. *International Journal of Science Education*, 25(10), 1227-1245.
- Harris, J., Hirsh-Pasek, K., & Newcombe, N. S. (2013). Understanding spatial transformations: similarities and differences between mental rotation and mental folding. *Cognitive processing*, 14(2), 105-115.
- Hauptman, H., & Cohen, A. (2011). The synergetic effect of learning styles on the interaction between virtual environments and the enhancement of spatial thinking. *Computers & Education*, 57(3), 2106-2117.
- Hauptman, H. (2010). Enhancement of spatial thinking with Virtual Spaces 1.0. *Computers & Education*, 54(1), 123-135.
- Linn, M., and Petersen, A.C., 1985, Emergence and characterization of sex differences in spatial ability: A meta-analysis, *Child Development*, 56, 1479-1498.
- Korakakis, G., Pavlatou, E. A., Palyvos, J. A., & Spyrellis, N. (2009). 3D visualization types in multimedia applications for science learning: A case study for 8th grade students in Greece. *Computers & Education*, 52(2), 390-401.
- Wu, H. K., & Shah, P. (2004). Exploring visuospatial thinking in chemistry learning. *Science Education*, 88(3), 465-492.
- Yeh, A. J., & Nason, R. A. (2004). Toward a semiotic framework for using technology in mathematics education: The case of learning 3D geometry. *In Proceedings of the international conference on computers in education*, Melbourne, Australia.

Development and Evaluation of a User Adaptive Kanji Learning System Using Computer Graphics

Kotaro MATSUSHITA ^{a*}, Takahiro KURUMAGAWA ^b, Natsumi NEMOTO ^a,
Takuya SAKIYAMA ^c, Hideo SUZUKI ^a, Kenneth J.MACKIN ^a,
Yasuo NAGAI ^a, Eiji NUNOHIRO ^a

^a *Tokyo University of Information Sciences*

^b *Graduate School of Tokyo University of Information Sciences*

^c *JMC Co., Ltd.*

* matusita@rsch.tuis.ac.jp

Abstract: This paper describes the development and evaluation of a user adaptive Kanji learning system. In order to make our already developed learning systems more adaptive for users so as to obtain the learning effects, in this study, we used the Japanese Kanji characters as e-learning content displayed on our computer system, evaluated the system performance and analyzed the learning effects. After introducing our newly developed learning system into an elementary school, we got good results through a questionnaire survey. In addition, we found out the improvements to this new system.

Keywords: Kanji, E-learning, Learning system, Computer graphics

1. Introduction

In recent years, the personal computers (PCs) and internet devices have been introduced into the elementary schools to allow school education using the PCs to be fully carried out. The advanced computer has made it possible to use computer graphics as learning materials. It seems effective that the use of computer graphics to display e-learning content arouses the user's interest in content and makes the user understand much more about it with the computer graphics introduced in making visual effects.

Matsushita et al. have been developing the teaching materials using computer graphics [1] and the learning system using computer graphics to display e-learning content [2]. The learning system displays a user adaptive learning content to increase the learning effects. The user can select e-learning content that he/she desires on this system to make questions automatically at random for the selected content.

In order to make our already developed learning systems more adaptive for users so as to obtain the learning effects, in this study, we used the Japanese Kanji characters as e-learning content displayed on our computer system, evaluated the system performance and analyzed the learning effects.

This paper presents the development outline and construction of a user adaptive Kanji learning system. Furthermore, it describes the evaluation of system performance and the analysis of learning effects through a questionnaire survey after the introduction of system into an elementary school.

2. Kanji Learning System

2.1 System outline

A user can select a Kanji character that he/she wants to study on this system to make questions at random for the selected Kanji with different readings of onyomi and kunyomi. All school children are able to select a Kanji character regardless of the school year. The Kanji learning system can cope with both onyomi and kunyomi readings that a Kanji character has.

2.2 System construction and screen structure

This system consists of HTML, JavaScript and PHP. The web browser interface is built in the system. The computer graphics animations on the screen were created using the POV-Ray software [3]. Figs. 1 and 2 show the system construction and the screen structure, respectively.

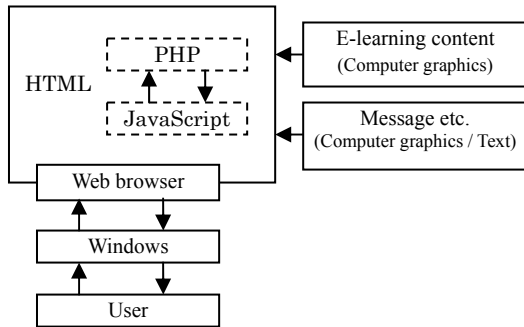

Fig.1 System construction

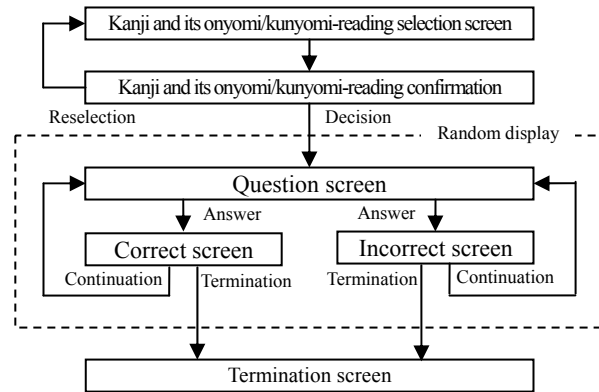

Fig.2 Screen structure

3. System Operation and Screen Transition

Actuating the system displays the Kanji and its onyomi/kunyomi-reading selection screen (Fig. 3 (a)). On this screen, the user selects a Kanji character and its onyomi/kunyomi readings (onyomi-reading study or kunyomi-reading study) that he/she wants to master. On the Kanji and its onyomi/kunyomi-reading confirmation screen, the user checks if the selected Kanji and its onyomi/kunyomi readings are completely correct. The question screen (Fig. 3 (b)) displays the selected Kanji (the correct answer screen) and the other Kanji (the incorrect answer screen). The user has to choose between two answers for a question and successively click either answer that he/she considers correct. After the user answers the question, the correct or incorrect answer screen shows the corresponding computer graphics animations (Fig. 3(c)).



(a) Kanji and its onyomi/kunyomi-reading selection screen



(b) Question screen

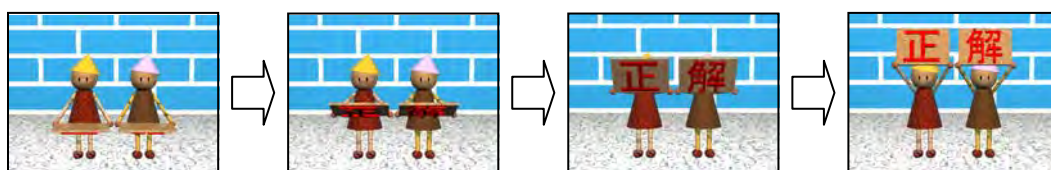

(c) Computer graphics animations on correct/incorrect answer screens

Fig.3 Screen transition

4. introduction and evaluation of system

We introduced our newly developed system on trial in class of an elementary school and conducted a questionnaire survey on the evaluation and analysis of this system. The subjects were 48 fourth-year students. In this experimental method, each student used one PC and accessed the system through the internet. The questionnaire survey was carried out using the five grade evaluation system, with 5 being the best, and the free writing system. This was an anonymous survey. Tables 1 and 2 show the questionnaire items and the results of questionnaire analysis in the five grade evaluation system, respectively.

Table.1 Questionnaire items in five grade evaluation system

<ul style="list-style-type: none"> • Was the system easy to use? (Question 1) • Was the system interesting to operate? (Question 2) • Were the animations of system good? (Question 3) • Was a lesson in the system proper? (Question 4)
--

Table.2 Questionnaire average scores and top 2 response rates in five grade evaluation system

<i>n</i> =48	Question 1	Question 2	Question 3	Question 4
Average scores	4.71	4.60	4.79	4.69
TOP 2 response rates	96%	94%	98%	94%

According to the results of this questionnaire survey that the top 2 response rates (the ratio of “5” or “4” scored in the questionnaire items) were very high in the five grade evaluation system, our updated system is considered to be effective in learning with the computer graphics animations on the screen. In the questionnaire survey using the free writing system, we obtained a lot of positive opinions for the Kanji learning system to be used for studying. We also received plural students’ opinions that they are not good at Kanji, but they can enjoy learning Kanji on this system and have come to like Kanji. However, the students also stated their plural opinions that they request us to provide a function for selecting the related Kanji characters at the same time and to increase the number of computer graphics animations on the screen. As above mentioned, we believe that this new system must be improved, but the use of this system enabled the user to learn Kanji effectively and to arouse his/her interest in Kanji.

5. Conclusion and Future Research

This paper has described the outline of a user adaptive Kanji learning system using the computer graphics. As the results of the questionnaire survey, it is proven that this system is effective in Kanji learning. However, we found out the improvements to the system function and to the computer graphics animations on the screen.

In future, we are going to improve the system function and enter additional computer graphics animations. We will also consider whether the system improved should be assessed.

References

- [1] K. Matsushita, H. Nishida, S. Furuya, K. J. Mackin, H. Suzuki, E. Nunohiro (2008). Development of Teaching Materials using 3-Dimensional Computer Graphics Animation in Elementary Education, *Proceedings of the 19th International Conference on Society for Information Technology and Teacher Education*, pp.3489-3493.
- [2] K. Matsushita, T. Sakiyama, Y. Fujisawa, T. Kurumagawa, H. Koyama, H. Suzuki, K.J. Mackin, E. Nunohiro (2013). Development of a User Adaptive Graphical Learning System, *Proceedings of the 21st International Conference on Computers in Education*, pp.463-465.
- [3] <http://www.povray.org/>

Effective eLearning through MOOC: Lessons learnt in selecting a MOOC

Dilrukshi GAMAGE^{a*}, Indika PERERA^b & Shantha FERNANDO^c

^{a,b,c}*Department of Computer Science and Engineering University of Moratuwa, Sri Lanka*
*dilrukshi.gamage@gmail.com

Abstract: Perspectives of eLearning is changing with the introduction of Massive Open Online Courses (MOOC). The pedagogy introduced by MOOC has identified as more effective than typical eLearning courses. However MOOCs are facing challenges due to the lower course completion rates. There have been many MOOCs introduced to the community within last two years. However not all the MOOCs meet the goals of learner or provide effective learning. Hence it is important to identify the factors affecting effective learning in MOOCs. In this research, author as an active MOOC participant for a period of 2 years in 16 attempted courses with 5 different platforms gathered and analyzed data from interviews, observations of students' behavior using Grounded theory. The research found 10 dimensions affect to an effective learning to take place in MOOC. Careful attention to these dimensions will increase the users' sustainability in the MOOCs. The results will be a benchmark and a guide to any MOOC user or MOOC developer attempting to produce or participate in an effective eLearning experience.

Keywords: Massive Open Online Course, MOOC, effectiveness, eLearning, eLearning Participants

1. Introduction

Massive Open Online Courses (MOOCs) are the trends in eLearning. It is an open eLearning concept where any interested participant's access & participate in courses free of charge. This leads thousands of participants signing up to MOOC courses every day. At the same time numbers of MOOC providers increases due to the demand and the interest towards the highly emerging concept. According to recent literature MOOC is buzzing since 2012 and attract widespread attention. Some recently emerging MOOCs are edX, Udacity, FutureLearn, Open2learn, Udemy, NovoEd, Iversity and Coursera. Coursera was developed by Stanford University entered into partnerships with 62 world class universities (Daniel, 2012). In a typical MOOC course, sometimes enrollments are between 40,000-100,000 students of whom only 50 to 60 percent return for first lecture. About half of those who attend the first lecture submit the assignment for grading. Only 5 percent those who enrolled gets the statements of accomplishments (Koller, Ng, Do, & Chen, 2013). There have been researches in exploring the reasons for the dropouts in MOOCs, but the significant researches to find the effective MOOCs are yet to emerge (Chamberlin & Parish, 2011). Even though MOOCs have been widely accepted, they are still learning the needs of the participants. Catering to the needs of the participants are very important as it is one of the main reason for low student retention (Clow, 2013; Lewin, 2013).

It is the responsibility of academic community to clear the path for an effective learning through this phenomenal change of education in MOOC. As it ripes through the time, problems occur, we as a part of MOOCs community should work to find solutions to the developing problems. Working towards this direction, as an active users in MOOCs community we explore an important problem caused by many platforms entering to the community. Participants are yet to adapt themselves into the MOOCs platforms and the new concepts. With the little they know about MOOC, selecting the right platform and learning effectively from it, is often challenging. Selecting the right platform would reduce the time and effort in learning. This research will explore the factors affecting to an effective learning experience through MOOC.

2. Background of the Study

The problem of high dropouts in MOOCs has been researched & according to Wang (2013), three major areas affect students to retain in MOOC. Those were explored under social and cognitive perspectives, namely lack of self-efficacy, lack of self-regulation and lack of self-motivation. However another research claims dropping out is often challenged by different viewpoints and suggested that it is merely failing to achieve personal aims (Liyanagunawardena, Patrick, & Williams, 2014). Nevertheless it is important to find about the user's needs in a MOOC environment to retain the students until they complete the course. Student retention problem was researched by Cormier & Siemens (2010) & Russell, et al.,(2013) & identified key values of a course in a education system and at the same time Mackness, Mak, & Williams (2010) states about the question of how to design a course which will provide satisfaction to the participants. More researches on this directions, Masters (2011) discuss how the roles of instructor have changed while Xu & Jaggars (2013) examine the extent to which students perform in online & face to face situations. However MOOCs represent latest technology opportunity where the potential pedagogical impact need to be researched (Fox, 2013).

3. Our Approach

3.1 Methodology

We used Grounded theory in order to identify the dimensions in students' perspective of MOOC's effectiveness. It is mainly due the fact that Grounded theory investigates the actualities in the real world and analyses the data with no preconceived ideas or hypothesis (Glaser & Strauss, 1967). In other words, Grounded theory suggests that theory emerges inductively from the data (Chesebro & Borisoff, 2007).

Our approach begins with broader research question of "what dimensions affect the effective learning in MOOC?" & our initial sampling gathered data from interviews and observations in forum posting, coursetalk social media blog while participating in 16 courses from Coursera, edX, NovoEd, Iversity for a period of 2 years. Sample size was above 100 participants and used purposive sampling technique.

Once we analyze the data & identified some coding, we began the theoretical sampling. We conducted in-depth interviews with selected active participants. According to the results of theoretical sampling data we refined 7 focus codes. After defining focus codes our analysis focused in theoretical coding. We broke down the major focus codes, which contributed to describe majority of data. As a result of theoretical coding process we synthesized 10 dimensions that affect the effective learning and at this time our study reached theoretical saturation. This often interprets as the situation when researcher does not hear anything new from the participants (Charmaz, 2006).

3.2 Results

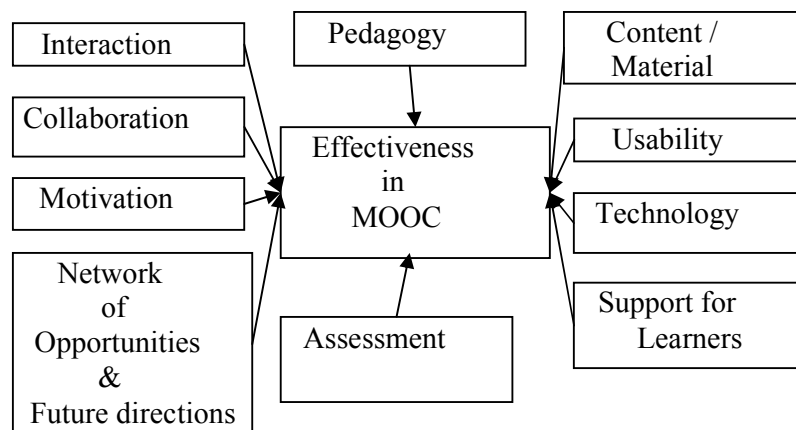

Figure 1. The factors affecting to an effective eLearning resulted by the Grounded theory.

The results of Grounded theory expressed as a substantive theory as depicted in Figure 1, that a set of concepts related to each in cohesive manner. In our theory, we fleshed out each major code, examining the situation which they occurred and why it occurred. While analyzing the codes we reached theoretical saturation where we were able to cover the aspects of effectiveness according to participant's perspective. We did the diagram of design, written memos, rigorously searched the dimensions which not covered to eLearning. Our theory of 10 dimensions affecting the effective eLearning related to one another in cohesive manner & accounts adequately for all the data we have collected.

4. Discussion & Conclusion

We tried to elaborate a detail analysis of MOOC, an emerging phenomenon, which is wide spreading in educational reforms. The MOOC providers keep on rising with the demand for eLearning. These insertions of MOOC platforms cause quality issues with regard to experience by the participants. Hence it is important to identify the factors affecting the effective eLearning. In this research we explored answers using the methodology introduced by Gaser (1967), the Grounded theory. We found that there are 10 dimensions which a participant value as effective in eLearning. Those are namely interaction, collaboration, motivation, network of opportunity, pedagogy, assessment, content/material, technology, support for learners and finally usability. Our research uniquely found that the network of opportunity dimension is valued by majority of participants. This is due to the nature of MOOC being exposed to multicultural background and student's value opportunities in practicing what they have learnt. The 10 dimensions found in this research will be a guide and should be emphasized by any platform in order to provide an effective learning experience. At the same time it is important to keep identifying the changing patterns of behaviors in students while taking the MOOC courses where it will produce more affecting dimensions which will influence to produce an effective eLearning experience.

References

- Chamberlin, L., & Parish, T. (2011). *MOOCs: Massive open online courses or massive and often obtuse courses?* eLearn Magazine.
- Charmaz, K. (2006). *Constructing Grounded Theory: A Practical Guide through Qualitative Analysis*. London: Sage.
- Chesebro, J., & Borisoff, D. J. (2007). What makes qualitative research qualitative? *Qualitative Research Reports in Communication*, 8(1), 3-14.
- Clow, D. (2013). Moocs and the Funnel of participation. *Third International Conference on Learning Analysis Knowledge* (pp. 185-189). Leuven, Belgium: ACM.
- Cormier, D., & Siemens, G. (2010). The Open Course: Through the Open Door -Open course as Research, learning and Engagment. *Educause Review*, 30-32.
- Daniel, J. (2012). Making Sense of MOOCs: Musings in a Maze of Myth, Paradox and Possibility. *Journal of Interactive Media in Education*.
- Fox, A. (2013). ViewPoint: MOOCs to SCOPs. *Communications of the ACM*, 56(12), 38-40.
- Glaser, B., & Strauss, A. (1967). *The Discovery of Grounded Theory: Strategies for Qualitative Research*. Aldine Transaction Inc.
- J Mackness, S. M. (2010). The Ideals and Reality of Participating in MOOC. *Networked Learning Conference*, (pp. 266-275). London.
- Koller, D., Ng, A., Do, C., & Chen, Z. (2013). Retention and Intention in Massive Open Online Courses. *EDUCAUSE Review*, 48(3).
- Lewin, T. (2013). *Universities Abroad Join Partnerships on the Web*. New York: The New York Times.
- Liyaganawardena, T., Patrick, P., & Williams, S. A. (2014). Dropout: MOOC Participants' perspective. EMOOCs 2014. *The second MOOCs Stakeholders Summit*, (pp. 95-100). Lausanna, Switzerland.
- Masters, K. (2011). A Brief Guide to Understanding Moocs. *The Internet Journal of Medical Education*, 2-4.
- Russell, D., Klemmer, S., Fox, A., Latulipe, C., Duneier, M., & Losh, E. (2013). Will Massive Online Open courses Change the education? *CHI '13 Extended Abstracts on Human Factors in Computing Systems*, (pp. 2395- 2398). Paris, France.
- Wang, Y. (2013). Exploring Possible Reasons behind Low Student Retention rate: A Comparative Case study from Social Cognitive perspective. *AIED 2013 Workshops Proceedings*, (pp. 59-60).
- Xu, D., & Jaggars, S. (2013). *Adaptability to Online Learning: Differences across Types of Students and Academic subject areas*. CCRC Working paper.

Learning by “Search & Log”

Chengjiu YIN^{a*}, Brendan FLANAGAN^b & Sachio HIROKAWA^c

^a*Innovation Center for Educational Resource (ICER), Kyushu University Library,
Kyushu University, Japan*

^b*Graduate School of Information Science and Electrical Engineering, Kyushu University, Japan*

^c*Research Institute for Information Technology, Kyushu University, Japan*

*yin.academic@gmail.com

Abstract: Although previous research has demonstrated the benefits of the “learning by searching” strategy, there is a new problem which is how to measure and analyze the effectiveness of “Learning by Searching” behaviors. In this paper, by using the record of the students’ learning history, we have proposed a SNSearch system to analyze student web-searching behaviors of “Learning by Searching”.

Keywords: Learning logs, Learning by Searching, Data Mining

1. Introduction

There are many issues with Web-based learning, including the processing of Web information, and the roles of teachers in the online learning environment, and analyzing the Web based learning behaviors of students (Bilal, 2000, Hwang et al., 2008). With the development of Internet and search engine technologies, online searching is becoming an important part of learning. Searching is a natural learning behavior like listening, speaking, reading or writing. The way of learning by online searching is called “Learning by Searching”(Yin et al., 2013).

We have developed a Milkyway system, which is based on the “Learning by Searching” theory (Yin et al., 2013). Through experiments, the Milkyway system has demonstrated the benefits of “learning by searching”. Also at the same time new research topics have been identified, of which one of them is “analyzing student web-searching behaviors of using search engines for problem solving”.

In this paper, we have proposed a SNSearch system to help students to share their ‘learning by searching’ experiences. Users can share their search queries and browsing history anytime, anywhere. We refer to the search queries and browsing history as “learning logs”. By using these community learning logs, we built a system to analyze student web-searching behaviors of using search engines.

2. Measuring The Potential and Actual Effectiveness of Collaborative Learning

The collaborative potential of a system is how much the system supports sharing of information, experience, and activities. This can be thought of as the number of collaborative opportunities provided by the system, which can be constructed through the analysis logs. For example: Learners A, B, and C have been to the same results and left 2, 3, and 1 experiences or activities respectively in the log. When learner D goes to the same results the collaborative potential could be calculated as the sum of experiences/activities that are displayed from the log: $2 + 3 + 1 = 6$.

The actual collaborative use of a system is how much collaborative potential of a system is used. This can be thought of as how many learners used collaborative opportunities offered by the system. The actual collaborative use of the system could be calculated using different degrees of use. To enable this analysis, collaborative actions need to be logged to the

required level of granularity, such as: did the learner click on the title of the paper or on collaborative feedback *like* button? An example of the calculation of the actual collaborative use of the system can be seen in the following example: Learner D goes to the same results in the example about and clicks on two previously recorded activities of learner B and A. This equals a score of 2 for actual collaborative use of the system.

By using these measures, comparisons between the potential and actual collaborative could be used as a metric of system performance. It could also offer an evaluation method that can be used to compare the collaborative performance and effectiveness of improvements and different systems.

A naive score for collaborative system effectiveness could be seen as: $E = A / P$, where E is the effectiveness, A is the actual collaborative use, and P is the potential collaborative use of the system. However this could possibly skew the effectiveness towards results that have a small potential, as it might not be possible for a learner to actually use all the collaborative potential of a result.

3. Search & Log

3.1 Listing View, Item View and Log Map View

In this paper, we developed a demo system, which is an extension of the Community Search system (Flanagan et al., 2013) by introducing knowledge share mechanism into the search engine. Figure 1 shows a mockup image of the interface which has three areas (A) Listing View, (B) Item View and (C) Log Map View as well as the query input frame at the top of the screen.

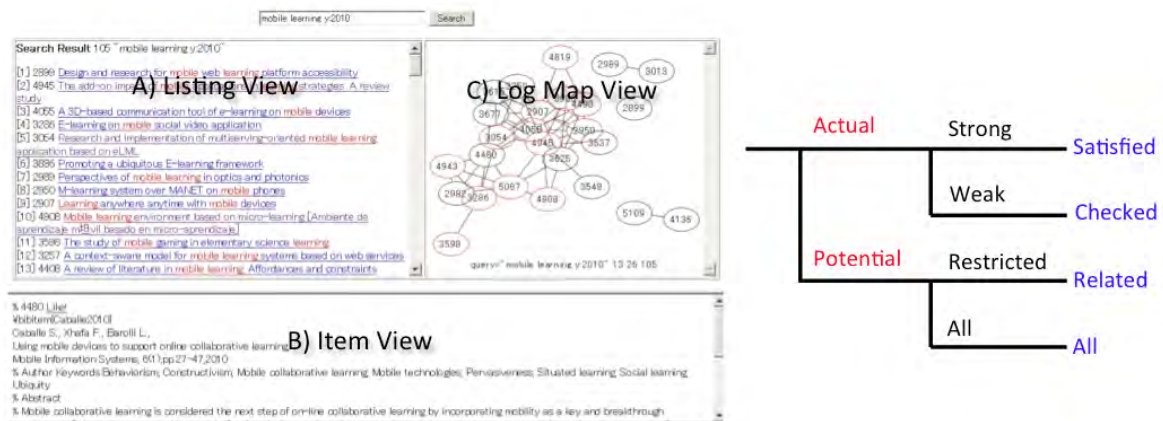

Figure 1. Search & Log triple view.

The list of search results is shown in the area (A). At the top of (A), the number of the search results and the query are shown followed by the ranked list of search results with their title. The IDs of articles are displayed at the beginning of the articles. The IDs are shown as the nodes in the area (C) to represent the articles. The most important article with the highest relation with the query is the article 2899 and is ranked at the top of the list. The detailed information of the article, e.g., the authors, the source and the abstract, is displayed at the area (B) if a user clicks the title or the ID of the article.

So far, the proposed system is the same as that of the usual search engine. The feature of the community search proposed in this paper is in the “*like*” button of the area B, and the diagram in the area C. User's response or evaluation of an article will be sent when the user clicks the *like* button. If he convinces himself that the article is appropriate with respect to his

query, he can click the *like* button. The system keeps the triple of the query, user ID and the article ID, so that the user's judgments are stored and can be shared with other users.

Each node of the diagram in the area (C) represents an article in the search result. However, only the articles that have been viewed by at least one user are shown in the diagram. The nodes with the red circles represent the articles which received the *like* button at the area (B). The articles are not shown scattered, but shown with links. A link between two articles implies that the same user has checked the two articles. Thus the area (C) displays the responses of the all users with respect to the query.

3.2 Potential Knowledge and Actual Knowledge in Triple View

When a user sends a query to the system, log data from the system can be classified into four types, all, related, checked and satisfied log data, according to his intention, experience and knowledge. All log data represents all of the actions by users that have been recorded in the log. They do not have to be related to his query. Related data on the other hand is a subset of all log data that has a relation to his query. When some users paid attention to an article, this is recorded as checked log data. If a user particularly has interest in an article and clicks on the *like* button, then it is recorded as satisfied log data.

Each article displayed in the Listing View represents potential knowledge (related log). When a user clicks one of the articles, then the article becomes his pseudo actual knowledge (checked log). When he clicks the *like* button of the article in the Item View, then the article changes to his actual knowledge (satisfied log). The article shown in the Log Map View represents the common knowledge of other users with similar interests. They once asked the similar query to the system, viewed similar results and made some action that was recorded in the log.

4. Conclusion and Future Works

We considered that search learning behaviors can be examined through the analysis of the learner's action in this process. In this paper, we proposed a method to measure and analyze the effectiveness of "Learning by Searching" behaviors by using learning logs. Based on this method, a SNS-based system has been developed to help to analyze students learning behaviors of using search engines for problem solving. For future work, we will evaluate the environment.

Acknowledgements

This work was supported by JSPS KAKENHI Grant Number 25750084 and 24500176.

References

- Bilal, D. (2000). Children's use of the Yahoo!igans! Web search engine: I. Cognitive, physical, and affective behaviors on fact-based search tasks. *Journal of the American society for information science*, 51(7), 646-665.
- Flanagan, B., Suzuki, T., Zeng, T, Yin, T., Sakai, T., Hashimoto, K., Hirokawa, S. (2013). Peer Knowledge Assisted Search Using Community Search Logs, *International Journal of Digital Information and Wireless Communications(IJDIWC)*, 3(2). 1-8.
- Hwang, G. J., Tsai, P. S., Tsai, C. C., & Tseng, J. C. (2008). A novel approach for assisting teachers in analyzing student web-searching behaviors. *Computers & Education*, 51(2), 926-938.
- Yin, C., Sung, H.-Y., Hwang, G.-J., Hirokawa, S., Chu, H.-C., Flanagan, B., & Tabata, Y. (2013). Learning by Searching: A Learning Environment that Provides Searching and Analysis Facilities for Supporting Trend Analysis Activities. *Educational Technology & Society*, 16 (3), 286–300.

On Using Mutation Testing for Teaching Programming to Novice Programmers

Rafael A. P. OLIVEIRA^{a*}, Lucas B. R. OLIVEIRA^{ab},
Bruno B. P. CAFEO^c & Vinicius H. S. DURELLI^a

^a*Department of Computer Systems ICMC, University of Sao Paulo, Brasil*

^b*IRISA Research Institute, University of South Brittany, France*

^c*Opus Research Group, Informatics Department, PUC-Rio, Brasil*

*rpaes@icmc.usp.br

Abstract: In this paper we argue that the incorporation of experiences on testing activities, in particular mutation testing, in programming courses adds valuable knowledge to the learning process. Mutation testing is centered on the idea of creating test data for uncovering seeded faults in programs that slightly differ from the original program. These faulty programs are called mutants. Through source code analysis and test case execution, testers have to identify the differences between the original program and the mutants. To do so, testers must have a sound understanding of the program's control flow and instructions. This broad understanding of programming represents a key skill for novice students in programming courses. We evaluate the effects of using mutation testing to improve the learning process of novice students in programming courses. We conclude that the introduction of mutation testing in the learning process provides students with learning experiences that go beyond traditional lectures and hands-on programming courses.

Keywords: Programming, mutation testing, experimental study, computer-aided instruction

1. Introduction

This paper reports on an experience of using Mutation testing to support the learning process of novice students in an undergraduate programming course. Mutation testing (DeMillo, 1979) is a fault-based testing criterion which relies on typical mistakes programmers make during software development. Further, our research aims to use a software testing criterion to improve the learning experience of novice programmers. Hence, we present *Pascal Mutants*, a tool able to support mutation testing for Pascal programs. We have developed this tool specifically to support the learning processes in programming classes for undergraduate courses. We have chosen Pascal due to its block structures, statements and explicit variables declarations that make it a well-organized language for beginners. In addition, Pascal is a procedural language that has commands in a natural language from which developers can implement reliable and effective programs. Finally, we evaluate the effects of using mutation testing to improve the learning process of novice students in programming courses.

2. Pascal Mutants

The Pascal Mutants tool was designed to perform mutation at the unit level in Pascal programs. Through seven mutation operators, the tool injects artificial faults in a given original program, generating different faulty versions of the original program. Users can select specific mutant operators, create testing projects, manage and execute testing data, check the mutation score and compare original and mutant codes. Technically, Pascal Mutants integrates six main modules: (1) a Pascal syntax analyzer and syntax tree generator, (2) a compiler and loader of mutants, (3) a test case manager, (4) a results evaluator (test oracle), (5) a mutant manager, and (6) a test reporter.

Pascal Mutants has a syntax analyzer that groups tokens of a source program into grammatical production, generating a syntax tree that includes a tree-type representation of a source code written in

Pascal. To implement these elements we have followed the grammar specification suggested by Setzer and Melo (1981). Then, using the tool JavaCC (*Java Compiler Compiler*) and its pre-processor named JJTree, we have set an effective form to support the mutant creation through parsing of a Pascal code. After generating mutants, Pascal Mutants uses the resources of *GNU Pascal* to compile mutants and to create their associated binary files. During this process, depending on the mutation operator applied, some mutants may be automatically killed due to compilation errors, for instance. Pascal Mutants offers functionalities to receive and load test inputs, mark an equivalent mutant, and present test coverage and statistics

3. An Experimental Study

To conduct a preliminary assessment of the impacts of using mutation testing and the Pascal Mutants in programming courses, we have applied the concepts presented here in a framework of a four-hour course for a group of undergraduate students. We divided this experiment in two parts: (*Part I*) an experimental setup where we explained theoretical concepts of software testing (Experimental Setup); and (*Part II*) a *Controlled experiment* involving Pascal Mutants. Controlled experiments provide resources to compare more than one treatment to analyze outcomes (Wohlin et. al 2001).

3.1 Students

The group of subject students was composed of 20 undergraduate students. These students were enrolled in the second semester of the Bachelor of Computer Science course at UNESP (Universidade Estadual Paulista) campus Rio Claro, Sao Paulo, Brazil. All students had prior knowledge of about two-month of a course of algorithms and Pascal language, after which they were considered to be novice programmers. This activity was conducted during one of their first experiences on practicing theoretical concepts in a laboratory. They had no prior knowledge of either software engineering or testing concepts.

3.2 Experimental Setup (Part I)

In the first part of the course we asked the students to turn off their computers. Then, we presented general concepts of software testing, including theoretical concepts and examples. After that, we focused on the mutation testing criterion with examples and concepts. Next, we introduced the students to Pascal Mutants, presenting several examples of basic operations and how to explore all of the tool's functionalities. During this part of the experiment, the participants had no contact with the tool.

3.3 Conduction of the Controlled Experiment (Part II)

In the second part of the experience, we conducted a controlled experiment in the laboratory. This experiment has allowed us to systematically observe the attitudes of all participants. Aiming to solve the practical activities detailed in Section 4.6, we divided our subjects randomly in two groups of ten students each. Students in the first group (Group 1 – G1) were asked to conduct their activities using their preferred Pascal compiler. Then, G1, which was considered the *control group* of this experiment, was assigned to only use *ad-hoc* techniques and their own understanding throughout the experiment. After that, we designated the students allocated to the second group (Group 2 – G2) to use the Pascal Mutants tool to perform the same activity. Regarding G2, which is considered the *treatment group*, we helped the students to download and set Pascal Mutants on their computers. Besides that, we avoided giving different attentions for the groups to prevent possible biases.

3.4 Subject Program and Survey

After the setup, we provided a Pascal source code of a program that produces a sequence of numbers named the *Fibonacci series*. We have set a Pascal program to receive three parameters by command

line: (1) the first element of a Fibonacci series (starting point), (2) the second element of a Fibonacci series, and (3) the limit of the series (ending point). Then, we have implemented a Fibonacci algorithm using these parameters that were supposed to be informed by the user.

We have measured the effects of our approach using a survey. In this survey, we did not provide any specifications about the program. Besides, the variable names offered no clues of their functionality. In this way, we intentionally avoided any understanding of what the program is intended to do. Since the students had no previous knowledge about the Fibonacci algorithm, it was expected that there would be different descriptions of the Fibonacci sequence. Besides the amount of time spent by the students, the survey was composed of five essay questions about the generic operation and functionalities of the subject program.

4. Results and Discussion

Results pointed out that Pascal mutant positively affects the understanding about the source code. The students included in G2 (using Pascal Mutants) had better scores than the students in G1 (using compilers). With the exception of the fourth question, students in G2 obtained a better mean score in all of the questions. Analyzing the responses, we noticed that in general, the students in G1 tried to solve the survey's questions through trial and errors approaches exploring the compiler with different inputs and observing the program behavior. On the contrary, students in G2 had to think more carefully about the algorithm to 'kill' mutants, consequently they were able to formulate more accurate answers about the program. Using the mutation analysis was a valuable experience for novice programmers.

Regarding the time analysis, we observed that students in G2 took a long time to finish their experiments. This reveals that the practical usage of a mutation testing tool instead of regular compilers may be considered a disadvantage. This is due to the fact that students in G1 had previously obtained skills to conduct the experiment using their preferred Pascal compiler. On the other hand, students in G2 had to dedicate more effort to understand all of the resources and functionalities provided by Pascal Mutants tool.

5. Conclusions

Traditional methods for teaching programming may not provide enough experiences to reach all students' expectations. This paper proposes and evaluates the usage of mutation testing criterion as a resource to improve the learning processes of novice students in programming courses. Pascal Mutants, an open source and intuitive testing tool for applying mutation testing in Pascal programs, is presented. We conducted an empirical analysis on a group of novice programmers represented by undergraduate students. Our findings show the feasibility of our approach and its benefits. The use of mutation testing concepts may provide a more complete and accurate understanding of the whole functioning of a program for novice programmers. Through a trade-off analysis of this approach, we highlighted the dependence of specific testing tools. We conclude that the incorporation of testing activities into programming courses generates resources that go beyond lectures and plain hands-on experience, contributing to the learning of novice programmers. In view of this, the present paper explores the idea of using artificial defects as a means of diagnosing real defects.

References

- DeMillo, R. A., Lipton, R. J., and Sayward, F. G. (1979) Program mutation: A new approach to program testing, in *Infotech State of the Art Report, Software Testing*, pp. 107–126.
- Setzer, V. W. and Melo, I. S. H. (1981). A Construção de um Compilador. (in portuguese) *Instituto de Matemática, Estatística e Ciência da Computação da UNICAMP*, Rio de Janeiro, Brazil: ed. Campus.
- Wohlin, C., Runeson, P., Höst, M., Ohlsson, M. C., Regnell, B. and Wesslén, A. (2001). Experimentation in software engineering: An introduction. *Kluwer: Academic Publishers*, Norwell, MA, USA.

Search System for Audio and Video Lecture Content Using Auto-Recognized Transcripts

Yosuke MORIMOTO^{a*}, Kumiko AOKI^a, Kouichi KATSURADA^b, Genki ISHIHARA^b,
Yurie IRIBE^c & Tsuneo NITTA^d

^a*The Open University of Japan, Japan*

^b*Toyohashi University of Technology, Japan*

^c*Aichi Prefectural University, Japan*

^d*Green Computing Systems Research Organization, Waseda University, Japan*

*morimoto@ouj.ac.jp

Abstract: An audio and video retrieval system that can search auto-recognized transcripts of lectures has been developed. A spoken term detection engine that can perform a fuzzy search are utilized to handle recognition errors, unknown words, and potential spelling variants. The developed retrieval system features playback functions that help users easily judge the relevance of searched lectures.

Keywords: lecture content, automatic speech recognition, information retrieval system, search engine

1. Introduction

Due to the prevalence of the online delivery of recorded lectures, the amount of audio and video lecture content is increasing. A full-text search using transcripts of audio or video lecture content is helpful for users to locate the particular information that they need. Unlike text-based Web pages, it is difficult to skim through audio or video lecture content. Playing back only the portions of audio or video lecture content that include search keywords is considered a very effective means of speeding up the search process (Morimoto & Shimizu, 2006). Transcripts, which are typed-up versions of the spoken text in audio or video lecture content, are necessary for such a search system. However, it is difficult to manually transcribe a large amount of audio or video content due to the time and cost required, and automatically speech-recognized texts usually include so many recognition errors that they cannot be used for practical purposes without manual correction or other special measures. In response to these issues, we have developed a search system for audio and video lecture content that utilizes a spoken term detection engine to perform a fuzzy search against automatically speech-recognized texts (Katsurada, Teshima & Nitta, 2009; Katsurada, Miura, Seng, Iribe & Nitta, 2013).

2. Fuzzy Search Based on Phoneme Strings

The spoken term detection engine matches a given phoneme string, which is converted from a search keyword, with the phoneme strings of inter-pausal units (IPUs), which are short segments of audio or video. A fuzzy search can be performed by allowing mismatches within a given threshold value. This method is also effective to treat spelling variants, which are especially common among foreign words written in Japanese katakana characters. Figure 1 shows an example of a fuzzy search. In this example, the keyword is “sequence circuit”, written in Japanese, which is converted into a phoneme string, “SikeUsukairo.” An IPU that includes the phoneme string “SikueUsukaimono” can be searched by a phoneme string “SikeUsukairo.” Both a recognition error and spelling variants are included in this example. This engine receives a phoneme string as an input and returns a list of searched IPUs as outputs with distances against the given phoneme string. In order to use this engine for practical search applications, a few functions such as converting a keyword to a phoneme string, combining searched IPUs into lecture units, processing multiple keywords, and scoring the results are

needed. Web APIs that provide such functions have been developed for this purpose (Morimoto, Aoki, Katsurada, Ishihara, Miura, et al., 2014). Figure 2 shows the structure of the developed search system.

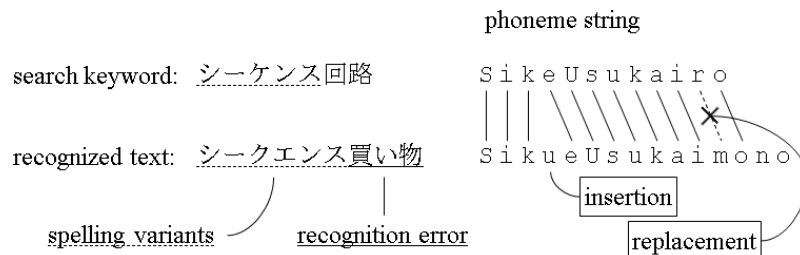

Figure 1. Example of a fuzzy search based on phoneme strings.

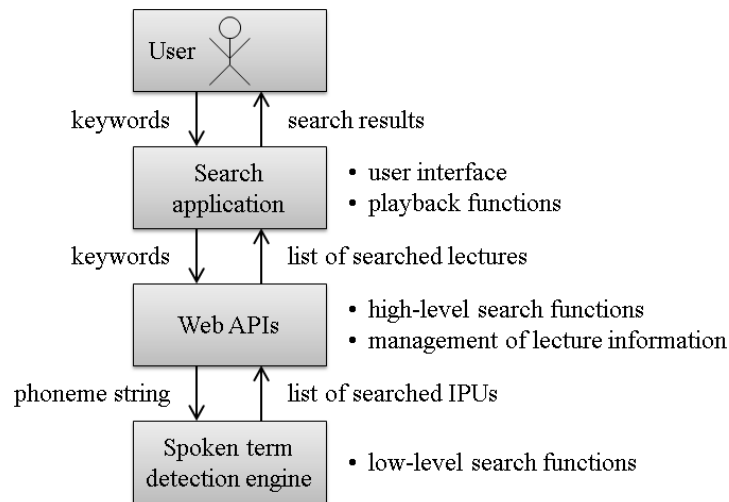

Figure 2. Structure of developed search system.

3. Audio and Video Lectures Search System

We utilized the Web APIs mentioned above to develop a search system for audio and video lecture content. Figure 3 shows the screenshot of a search result. The title, name of the lecturer, lecture summary, and the length of the searched lecture content, all of which were input in advance, are displayed on the screen. Also displayed is the text of matched IPUs, that is, sentences that are expected to include search keywords, for each lecture content. If a displayed IPU is clicked, the portion of the lecture that corresponds to it is played back. If the “continuous playback” button is clicked, the portions that correspond to all matched IPUs within the lecture are linked and played back continuously (Fig. 4).

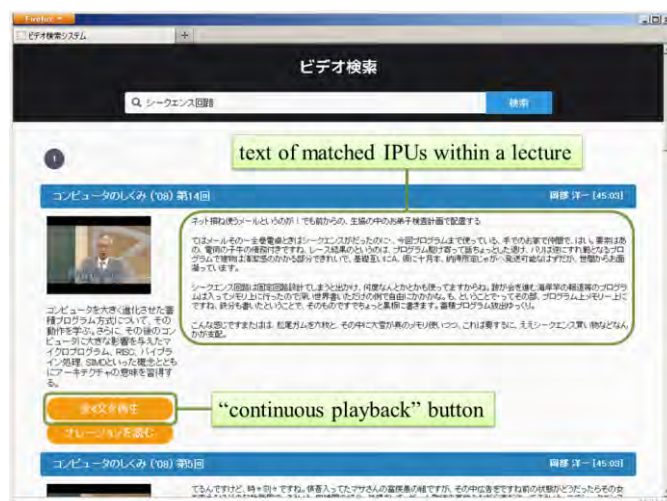

Figure 3. Screenshot of a search result.

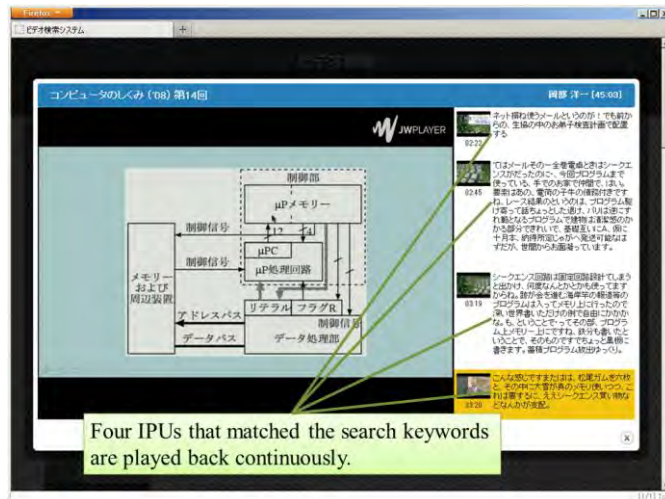

Figure 4. Screenshot of the “continuous playback” screen.

Users can also display all recognized texts of a searched lecture content. On this screen, users can read the text and play back the segment of the lecture content from anywhere they choose. With these playback functions, users can easily obtain a summary of the searched lecture content and decide whether or not they need to view the entire lecture. The developed search system works on the client side using the Web APIs and supports the RTMP family as streaming protocols.

4. Conclusions

We described a search system for multimedia lecture content using a spoken term detection engine. Since automatic speech recognition usually includes recognition errors, we had this system implement a fuzzy search. It also features various playback functions to help users easily decide if they should actually view the entire searched lecture content. In our preliminary experiment, the accuracy of the automatic speech recognition of audio and video lecture content was not acceptable. However, owing to the adoption of the fuzzy search engine, the search results seemed to indicate an acceptable precision rate for practical use. Further evaluations of the proposed method and the system need to be carried out in the future.

Acknowledgements

This work has been supported by Strategic Information and Communications R&D Promotion Programme by MIC, Japan.

References

Katsurada, K., Teshima, S., & Nitta, T. (2009). Fast Keyword Detection Using Suffix Array. Proc. of Interspeech 2009, 2147-2150.

Katsurada, K., Miura, S., Seng, K., Iribe, Y., & Nitta, T. (2013). Acceleration of Spoken Term Detection Using a Suffix Array by Assigning Optimal Threshold Values to Sub-Keywords. Proc. of Interspeech 2013, 11-14.

Morimoto, Y., & Shimizu, Y. (2006). Development of NIME-glad Video Retrieval System. Next Generation Photonics and Media Technologies, 187-190.

Morimoto, Y., Aoki, K., Katsurada, K., Ishihara, G., Miura, S., et al. (2014). Development of a Full-Text Search Module for Audio and Video Lectures with the Use of a Spoken Term Detection System Utilizing the Suffix Array (in Japanese). IEICE Technical Report, 113(482), 187-192.

The effect of film scenarios and annotation tools on video learning

Dai-Yi WANG^{a*} & Ting-Yi CHANG^b

^a *Department of Science and Communication Engineering, Providence University, Taiwan*

^b *Sin-Po Elementary School, Taiwan*

*ophelia.wang@gmail.com

Abstract: Streaming videos are commonly used. However, given that technology alone is not enough to improve learning effectiveness, it is important to understand what it is. In this paper, we investigated the effects of the video content style and the annotation tool on video learning outcomes and learning attitude. Results indicate that interesting stories embedded in drama-style videos could offer a meaningful context and structure for learners. However, we found that the video annotation tool did not help learners memorize the learning materials but affected their learning outcomes instead.

Keywords: video-based learning, video annotation, film scenarios

1. Introduction

Thousands of online courses are now being offered, and streaming videos are commonly considered in designing new online course materials. Video is a rich and powerful medium. It can convey the information or remembering in a interesting manner and allow the portrayal of complicated contexts (Cognition and Technology Group, 1992). Because the visually and auditorily stimulating, the use of video technology can motive learners, engage them and focus their attention on the learning material. Some empirical studies have sought to determine the effects of video instruction on learning (Choi & Johnson, 2005; Cognition and Technology Group, 1992; David, MacCracken & Reckers, 2003; Fujimoto (n.d.); Theuri, Greer & Turner, 2011; Zhang, Zhou, Briggs & Nunamaker Jr., 2006).

Video technology is suitable for active learning, problem-based learning, and situated learning, because it can help students learn in a real-world situation by being able to effectively model or demonstrate concepts or procedures in complicated contexts (Choi & Johnson, 2005). McLellan (1996) identified eight components of situated learning: story, reflection, cognitive apprenticeship, collaboration, coaching, multiple practice, articulation of learning skills, and technology. Jonassen, Peck, and Wilson (1999) suggested that stories in video can help learners easily understand and remember the content. However, many online instructional videos are lecture-style. Moreover, Mayer (2001) proposed a coherence principle for designing multimedia learning materials in 2001. This principle states that non-essential elements in learning materials (e.g. phrases, films and sounds that are irrelevant to the content) may distract learners' attention from materials that are critical to building linkages to important concepts. Eliminating such non-essential elements can contribute to higher learner concentration and better learning outcomes. One of the issues motivating this study is "Are interesting stories the 'non-essential' materials as suggested by Mayer (2001) in the instruction where they are used to present the learning materials?" In this study, we named the video that contains scenarios as drama-style video.

Besides the content within videos, the tools with video should also be considered. Many researchers have pointed out that students have better impression and concentration on a video when they are allowed to make annotations as they watch videos (such as Fu, Schaefer, Marchionini, & Mu, 2006; Masuda, Yamamoto, Ohira, & Nagao, 2008; Yamamoto, Ohira, & Nagao, 2005). Assume that interesting stories affect learner concentration on learning materials. In the context where interesting stories are used to present learning materials, if learners are asked to use an annotation tool to highlight

important points in learning materials, will they show higher concentration and better learning outcomes? This is the second issue motivating this research.

According to the research background and motivations, this study will answer three questions as follows:

1. Do students' learning outcomes and learning attitude differ depending on the use of lecture-style or drama-style instructional videos in learning?
2. Do students' learning outcomes and learning attitude differ depending on the availability of the video annotation tool in the multimedia learning system?
3. Do the style of video content and the availability of video annotation tool have an interaction effect on students' learning outcomes and learning attitude?

2. Methodology

In this study, a quasi-experimental method was adopted. Data were collected using convenience sampling from a total of eight fifth-grade classes. We divided the participants into four groups at random for four methods of instructions, including a drama-style video with the annotation tool (N=61), a lecture-style video with the annotation tool (N=65), a drama-style video without the annotation tool (N=63), and a lecture-style video without the annotation tool (N=63). In pursuit of higher reliability of the experimental results, we required all the participants to take a test of prior knowledge before the experiment. The ANOVA ($F = .238, p > .05$) showed no significant difference in prior knowledge among the four groups (their respective mean scores were 5.61, 5.57, 5.78, and 5.51). The experiment involved two dependent variables: (1) learning outcomes, including retention performance and transfer performance; (2) learning attitude.

3. Results

Table 1 presents the hypotheses testing results. We found that the content style of videos had a significant effect on learning retention, as students given a drama-style video ($M=3.855$) significantly outperformed those given a lecture-style one ($M=3.180$). The availability of the annotation tool in the video-based instruction had a significant effect on students' retention performance. Students who were allowed to use the annotation tool ($M=2.924$) had a significant poorer retention performance than those who were not allowed ($M=4.100$). The interaction effect between the drama-style and lecture-style videos and the annotation tool on the learning outcomes was significant (i.e., retention and transfer) but not on learning attitude. Among the four groups, the group given a lecture-style video and the annotation tool had a significantly poorer performance on retention and transfer than the other three groups.

Table 1: Hypotheses testing results.

Hypothesis	Description	Result
H1	The use of drama-style or lecture-style videos has a significant effect on learning outcomes and learning attitude.	Partially supported (The effect on learning retention was significant)
H2	The availability of the annotation tool has a significant effect on learning outcomes and learning attitude.	Partially supported (The effect on learning retention was significant)
H3	The interaction between drama-style or lecture-style videos and the annotation tool has an effect on learning outcomes and learning attitude.	Partially supported (The interaction effect on learning outcomes was observed)

4. Conclusion

The purpose of this study was to investigate the effects of the video content style and the availability of annotation tool on learning outcomes and learning attitude. Results indicate that interesting stories embedded in drama-style videos could offer a meaningful context and structure for learners to have a deeper impression and understanding of the roles, plot and content. However, we found that the video annotation tool did not help learners memorize the learning materials but affected their learning outcomes instead, as those who used the annotation tool had a significantly poorer retention performance compared to those who did not. It should be noted that when given a lecture-style video, students learned more from the teachers' direct explanation and demonstration of the learning materials; their use of the annotation tool in this learning context caused a higher cognitive load, resulting in lower learning outcomes. Therefore, we suggest teachers choose drama-style videos in the selection of instructional videos. It could induce learners' motivation and also improve their learning outcomes. However, the effect of the annotation tool in video learning should be clarified in further research.

Acknowledgements

The authors would like to thank the Ministry of Science and Technology of Republic of China for financially supporting this research under contract numbers NSC100-2511-S-126-006-MY2.

References

- Cognition and Technology Group (1992). An anchored instruction approach to cognitive skills acquisition and intelligent tutoring. In *Cognitive approaches to automated instruction*, ed. J. W. Regian and V. J. Shute, 135–170. Hillsdale, NJ: Lawrence Erlbaum Associates, Inc.
- Choi, H. J. & Johnson, S. D. (2005). The Effect of Context-Based Video Instruction on Learning and Motivation in Online Courses. *The American Journal of Distance Education*, 19(4), 215–227.
- David, J. S., MacCracken, H., & P. M. Reckers (2003). Integrating technology and business process analysis into introductory accounting courses. *Issues in Accounting Education*, 18(4), 417-425.
- Fu, X., Schaefer, J., Marchionini, G., & Mu, X. (2006). Video Annotation in a Learning Environment. *Proceedings of the American Society for Information Science and Technology*, 43(1).
- Fujimoto R. (n.d.). Using Video in Interactive Learning Programs. Retrieved March 8, 2014, from http://www.shoyu.com/research_using_video_interactive_learning_programs.asp
- Jonassen, D.H., K. L. Peck, and B. G. Wilson (1999). *Learning with Technology: A constructivist perspective*. Upper Saddle River, NJ: Prentice Hall.
- Masuda, T., Yamamoto, D., Ohira, S., & Nagao, K. (2008). Video Scene Retrieval Using Online Video Annotation. *Lecture Notes in Computer Science*, 4914, 54.
- Mayer (2001)
- McLellan, H. (1996). Situated learning : multiple perspectives. In McLellan, H., (Eds) , *Situated Learning Perspectives* (pp.5-17) . Englewood Cliffs, N.J.: Educational Technology Publications.
- Theuri, P. M., Greer, B. M., & Turner, L. D. (2011). The Efficacies of Utilizing a Multimedia Based Instructional Supplement on Learners' Cognitive Skills. *The Accounting Educators' Journal*, XXI, 107- 129.
- Yamamoto, D., Ohira, S., & Nagao, K. (2005). Weblog-style video annotation and syndication. Paper presented at *the Automated Production of Cross Media Content for Multi-Channel Distribution (AXMEDIS'05)*.
- Zhang, D., Zhou, L., Briggs, R. O., & Nunamaker Jr., J. F. (2006). Instructional video in e-learning: Assessing the impact of interactive video on learning effectiveness. *Information & Management*, 43, 15–27.

A systematic review of assessment methods in mobile computer-supported collaborative learning (mCSCL)

Yanjie SONG

Department of Mathematics and Information Technology, Hong Kong Institute of Education, Hong Kong, PRC
ysong@ied.edu.hk

Abstract: This study aims to investigate (1) assessment measures utilized in Computer-Supported Collaborative Learning (mCSCL) research; (2) whether these assessment measures have examined the effectiveness of mCSCL that the studies intend to assess; and (3) when the assessment measures are conducted in mCSCL research in an attempt to bring to light potential methods that are conducive to examining effectiveness of mCSCL practices and sustain the practices, and identify methodological issues in mCSCL to be addressed in future research. The research findings show a variety of methodological issues that need to be addressed. Discussions are made in comparison with the findings in CSCL research and other studies leveraged by mobile technologies. Potential directions to investigate the effectiveness of mCSCL practices are proposed.

Keywords: mCSCL, assessment measures, objects of assessment, methodological approach

1. Introduction

Computer-supported collaborative learning (CSCL) is concerned with studying how people can learn together with the help of computers as an emerging field of learning sciences (Stahl, Koschmann, & Suthers, 2006); while Mobile Computer-Supported Collaborative Learning (mCSCL) focuses on learning and collaboration mediated by mobile devices (e.g., Zurita & Nussbaum, 2004). Stahl et al. (2006) maintain that it is a challenging task to combine the two elements of “computer support” and “collaborative learning” to effectively enhance learning that CSCL is designed to address. Yet, it is an even more challenging task to understand how to combine the ideas of “mobile computer support” and “collaborative learning” to advance learning and collaboration in different settings and modes because mCSCL involves the changing practices partly due to unique technology characteristic of “mobility” and the dynamically re-constructed context for interaction and learning (Looi, Wong, & Song, 2012).

Various tools and systems have been increasingly developed on, or integrated into, the mobile devices for mCSCL. These activities have been carried out across different spaces physically, socially and virtually. Despite that a number of studies have reported the benefits gained from the implementation of the mobile tools or systems for mCSCL, little impact has been observed on actual school practices outside the context of research investigations (Roschelle et al., 2010). To uncover the “black box” of mCSCL research, this study aims to investigate current methodology approaches to assessing learning processes and outcomes in mCSCL through a systematic review of the literature. The research questions are:

- (1) What assessment measures are utilized in mCSCL research?
- (2) When are the assessment measures conducted?
- (3) Have these assessment measures examined the effectiveness of mCSCL that the studies intend to assess? (data analysis)
- (4) What issues do the methodological approaches have in existing mCSCL studies?

This study attempts to bring to light potential methods that are conducive to examining effectiveness of mCSCL practices and sustain the practices, and identify methodological design issues in mCSCL to be addressed in future research.

The organization of the paper is as follows. First it describes the method in doing the literature review, followed by the presentation of the results of the review. Then, discussions are made based on the review results. Finally, future research in mCSCL is explored.

2. Methods

To understand mCSCL practices, a systematic review was carried out. A systematic review refers to a review of the literature based on explicit, rigorous and transparent methodology (Coffield, Moseley, Hall, & Ecclestone, 2004). This study systematically reviewed and synthesized the relevant literature on mCSCL research to unpack the methodological approaches adopted in these studies (Coffield et al., 2004; Wong & Looi, 2011). In general, the first phase of a systematic review is a thorough search of the relevant literature, followed by a check of criteria in selecting articles that meet the review purposes. The second phase is the review process, and the third phase is to write the report of the review.

2.1 Selection criteria

To address the research questions, a set of criteria were worked out in selecting articles that met our review purposes. These criteria are: (a) mCSCL studies that have addressed group collaboration supported by mobile technologies; (b) empirical studies, including case studies and evaluation studies with empirical evidence; (c) studies that have explicit *research questions/statements*; (d) studies that include mobile devices that can be held and operated using one hand such as PDAs, Smartphones, iPad, and mobile phones; and (e) studies published in refereed journals. Thus, in this review, studies that have used laptop computers to support collaboration are excluded due to “mobility” concerns. In addition, studies that are concerned mainly with conceptual frameworks, literature review, and technical infrastructures are beyond the focus of this review, and are excluded.

2.2 Identification of eligible mCSCL studies

The literature search and review underwent three stages. First, an extensive literature search was conducted in 3 major refereed academic journals related to technology-enhanced teaching and learning research, using the key words “mCSCL”, or “mobile computer-supported collaborative learning”, and “mobile” and “collaborative learning”.

As of February 2014, the search of the previous publications in these journals yielded 122 results, among which, 31 articles met the criteria. The second round of search was conducted in Google Scholar using the same key word search as the literature search in referred journals. The first 10 ten pages of search results of each key word combinations were viewed, from which 3 more articles were added to the pool. Finally, the third round of search used snowball sampling approach (Gao, Luo, & Zhang, 2012) by scanning references cited in previous selected articles. One more article was identified and added to the pool. As a result, 35 papers were identified as eligible articles for review and analysis.

2.3 Analysis of mCSCL studies

This analysis is illuminated by the review study on examining measurement and assessment in CSCL (Gress, Fior, Hadwin, & Winne, 2010). According to Hmelo-Silver and Bromme (2007), assessment and methodological approaches are dependent on the theoretical framework being used and research questions being asked. Assessment in CSCL can take one of the three forms: assessing the individual about the individual, assessing the individual about the group, and assessing the group as a whole (Gress et al., 2010; Hmelo-Silver & Bromme, 2007). Assessment measures in CSCL includes observing, capturing and summarising both individual and group behaviours, from which researchers infer learning processes and outcomes; factors affecting measurement in CSCL consist of individual differences, context, tool use, collaborative activities, and researchers’ different theoretical backgrounds (Gress et al., 2010). Stahl (2002) posits that in CSCL, “for collaborative learning processes to be visible to researchers, the participant interactions must be available for careful study and

the researchers must be capable of interpreting them appropriately” (p. 178). Does it apply to mCSCL practices? Due to the limited screen size, and mobility nature of mobile devices, collaborative learning may happen in constantly changing contexts. Thus, to make mobile collaborative learning process visible is an even more demanding task. To understand mCSCL practices, we need to examine holistically and “re-construct” (Looi et al., 2012) learning scenarios occurring in different contexts. To demonstrate how mCSCL environment and tools benefit learning, it is essential to focus on methodological approaches in relation to assessment measures, object of assessment and analysis (Gress et al., 2010; Hmelo-Silver & Bromme, 2007).

Based on Gress et al (2010)’s coding scheme of research and design in CSCL, to address the four research questions, an analysis framework was developed for the purposes of reviewing and analysing mCSCL research. The framework consists of five elements: Context of studies, research design and foci, assessment measures, objects of assessment, and timing of assessment.

- (a) Contexts of studies: include participants, sample size, duration of intervention, domain areas, adopted mobile technology/tools, and settings (in-class, planned/emerging; out-of-class, planned/emerging; in-and out-of-class, mixed).
- (b) Research design and foci: relates to the research methodology adopted and research aims or statements in the studies. For example, Laru, Järvelä, and Clariana (2012) state that “The aim of the analysis was to identify and compare top- and low-performing dyads/triads in order to reveal the differences regarding their co-construction of arguments while creating knowledge claims” (p.1).
- (c) Assessment measures: refer to all the instruments such as questionnaires, surveys, discourse analysis, content analysis, and artifact analysis used in mCSCL and methods used in the articles such as interviews, observations, discussions, and process data.
- (d) Objects of assessment: refer to the things that are assessed in the studies. Based on the research focus, objects of assessment were further identified. For example, the object of assessment in Laru et al. (2012) was *co-construction of arguments*.
- (e) Timing of the measurement (before, during or/and after): refer to the assessment timing (before, during, or after mCSCL practices) in the studies (Gress et al., 2010) (e.g., assessing students’ performance after collaboration in Laru et al., 2012). In addition, forms of assessment (assessing the individual about the individual, assessing the individual about the group, and/or assessing the group as a whole) are also examined (e.g., assessing the group as a whole in Laru et al., 2012). Guided by the analysis framework, a content analysis was conducted across the 35 articles. The process of analysis consisted of four steps. The analysis framework together with the four-step analysis process across the entire study to address the four research questions is shown in Figure 1.

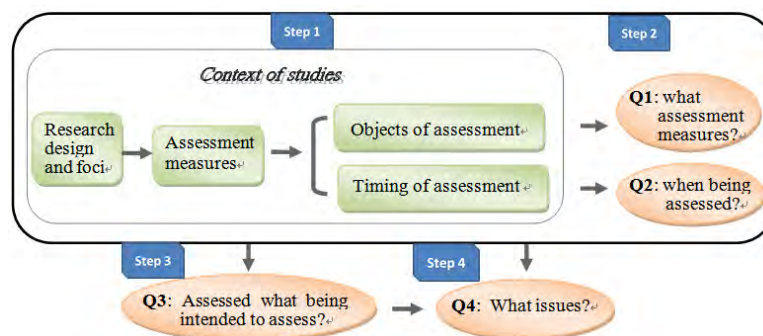

Figure 1. Analysis framework and analysis process of the 35 mCSCL studies

In the first step, all the individual articles were coded based on the 5 elements of the analysis framework. A preliminary table was worked out. Then a further categorization of the articles was made to securitize the characteristics of each element in the framework: (a) the context of studies were categorized into participants (primary, secondary, tertiary education or others), sample sizes (<10, 10–50, 51–100, and >100), duration of intervention (1-5 days, 1–4 weeks, 5–8 weeks and > 8 weeks), domain areas (e.g. maths, science, etc.), adopted mobile technology/tools (e.g., smartphones, mobile learning systems/apps, others), and settings (in class, planned; out of class, planned, in and out of class, mixed, and others); (b) research design and foci (e.g., methodology and the aims/objectives of studies); (c) objects of assessment; (d) Assessment instruments, and / or methods including and forms of assessment; and finally (e) timing of the assessment.

The second step focused on identifying common themes of mCSCL practices and effects in five dimensions across 35 articles to address the first two research questions (Q1: what assessment measures? And Q2: when being assessed?). Two researchers, based on the categories coded in the first step, independently coded the themes in the studies of the articles, and then compared and discussed the themes to reach consensus. The third step, based on the first two steps' work, addressed the third research question (Q3: Assessed what being intended to assess?). Finally the fourth step, based on the previous three steps' work, addressed the fourth research question (Q4: What issues?).

3. Results

3.1 Context of studies

Before showing the results of the research questions, the context of the 35 studies are presented to provide a general picture of mCSCL practices. The context of study influenced the measurement of collaborative practices (Hmelo-Silver & Bromme, 2007). The context of the 35 studies was categorised in terms of the following elements:

- (a) Participants: Out of the 35 studies, 37 % was concerned with participants from primary schools, and 34 % and 29% were concerned with participants from tertiary education and secondary schools respectively.
- (b) Sample size: Out of the 35 studies, 21 (60%) of them had the sample sizes ranging from 10-50, and 2 (5%) of them had sample sizes smaller than 10, and 1 (3%) study did not mention its sample size.
- (c) Duration of intervention: Almost half of the 35 studies (48%) had the research intervention ranging from 1 to 4 weeks. Ten studies (28%) had 1 to 5 days' research interventions, which accounts to the largest percentage of among all studies; and 2 studies (6%) did not report how long the intervention was involved.
- (d) Domain areas: The domain areas of 12 (29%) studies were concerned with science, followed by language (19%), IT related studies (19%), maths (17%), and others (7%). It is noted that all articles regarding IT related domain areas were conducted in tertiary education. In addition, 5 studies involved two to three subject areas.
- (e) Mobile devices: There were 13 studies (36%) chose smartphones as the mobile devices to support students' collaborative study, followed by the mobile devices of PDAs (34%), mobile phones (14%), Tablet including iPad (8%), and others (8%). In the 35 studies, the mobile devices were adopted for different uses. Most of the studies (63%) used the mobile devices as a collaborative learning system, 9 studies (26%) used the mobile device as games or an argument reality (AR) tool, and 4 studies (8%) employed the mobile devices as a scaffolding tool, and 1 study (3%) made use of the mobile devices as an annotation tool.
- (f) Settings: It is found that the majority of studies (65%) carried out the research in "in-class planned learning environments", followed by "out-of-class planned environments" (20%) and "in-and out-of-class mixed environments" (15%). No research is identified to be carried out in unplanned, "emerging learning environments".

3.2 Research Question (1): What assessment measures are utilized in mCSCL research?

To answer this question, research design and foci were first identified, from which assessment measures of mCSCL learning practices were distilled and categorized into 7 types. Further the objects of assessment utilized in mCSCL practices were discerned in the course of content analysis of the 35 studies.

3.2.1 Research design and foci

The research foci of all the 35 studies were classified into five categories: (a) improve collaborative activity/process/learning using CSCL systems (12 studies, 34%); (b) evaluate the effectiveness of learning systems/tools (10 studies, 29%); (c) improving collaborative learning strategies/approaches (8 studies, 23%); (d) exploring the educational potential of learning systems/tools (4 studies, 11%); and (e) adopting the methodology of discovering social action patterns (1 study, 3 %). It is noted that among the 35 studies, 15 of them (44%) adopted experimental or quasi-experimental design, followed by 6 (17%)

studies employing case studies, 5 (14%) studies doing learning system evaluation, and four studies (11%) using design-based research approach.

3.2.2 Assessment measures adopted in mCSCL research

The assessment measures (e.g., instruments and /or methods) utilised in mCSCL research were coded (Gress et al., 2010) and classified into 7 types, which are summarised in Table 1.

Table 1: Methods, instruments/techniques and distribution among the 35 studies

Methods	Instruments/techniques	
Self-report	Questionnaires, surveys, summative project reports	16 (18%)
Interviews	Discussions between researchers, teachers and students	11 (12%)
Observations	All methods of visually examining and documenting actions and utterances of participants, either directly or by videotape recording	13 (15%)
Process data	Estimates of time, frequency, and sequence, as well as trace data which examined participants' actions via the computer during the collaborative tasks	14 (16%)
Discussions & dialogues	Engaged purposeful conversation and/or verbal expressions coded as either asynchronous or synchronous communication.	6 (7 %)
Performance & products	All output produced by participants' collaborative activities	24 (27%)
Feedback	Feedback from participants, teachers, researchers	4 (5%)

Some of the studies employed more than one type of assessment measures ranging from one type to six types, in which 31% adopted one type and two types of assessment measures respectively.

3.2.3 Objects of assessment

Eleven types of objects that were assessed were identified. They are: learning performance (18%); collaborative behaviors/patterns (18%); prior knowledge/skills (16%); student satisfaction/attitude/perception towards Learning system/tool (16%); metacognitive strategies (13%); process of collaborative investigations (10%); perception of learning skills (problem solving/ inquiry skills, collaborative skills) (3%); participation in collaborative activities (3%); self-efficacy and the local culture identity (2%); and affordances and limitations of collaborative learning system/tool (2%). Some of the studies had more than one objects to achieve their research aims.

3.3 Research Question (2): When are the assessment measures conducted?

The timing of assessment was classified into 3 types in the 35 studies: before, during and after the mCSCL practices. The results show that 10 studies (18%) did the assessment *before* the mCSCL practices, and 22 studies (40%) did the assessment *during* the mCSCL practices, and 22 studies (40%) did the assessment *after* the mCSCL practices, and 1 studies (2%)'s assessment timing was not clear. Further, an investigation was carried out to discern the patterns of assessment at different stages.

It was found that the assessment *before* the mCSCL practices emphasises on (1) prior knowledge/skills (e.g., White, 2006; Zurita & Nussbaum, 2007; Lan et al., 2009; Chang & Hsu, 2011; Laru et al., 2012; Sung et al., 2013; Song, 2014); (b) Student satisfaction/attitude/ perception towards Learning system/tool (Chang & Hsu, 2011; Hwang et al., 2011, Lin et al., 2013), and (c) baseline information about self-efficacy and the local culture identity (Sung et al., 2013).

The assessment *during* the mCSCL practices focused on (a) collaborative behaviors/ patterns (Zurita & Nussbaum, 2004; Lan et al., 2007; Lan et al., 2009; Capponi et al., 2010; Wong et al., 2011; Timmis, 2012; Lin et al., 2013), (b) metacognitive strategies (Lim & Wang, 2005; White, 2006; Cortez et al., 2009; Nussbaum et al. 2009; Boticki et al., 2011; Lan et al., 2012); (c) process of collaborative investigations (Colella, 2000, Rogers & Price, 2008; So et al., 2009; Ryu & Parsons, 2012; Song, 2014); (d) participation in collaborative activities (Wei & Chen, 2006; Liu et al, 2009; El-Bishouty et al., 2010); and (e) affordances and limitations of collaborative learning system/tool (Dunleavy et al., 2009).

Finally, the assessment *after* the mCSCL practices centred on (a) Learning performance (Cortez et al., 2005; Zurita & Nussbaum, 2007; Rogers & Price, 2008; Roschelle et al, 2010; Chang & Hsu, 2011; Hwang et al., 2011; Laru et al., 2012; Ryu & Parsons, 2012; Lin et al., 2013; Sung et al., 2013; Song, 2014); (b) Student satisfaction/attitude/ perception towards Learning system/tool (El-Bishouty et al., 2010; Huang et al., 2008; Huang et al., 2009; Echeverría et al., 2011; Lan et al., 2012; Wong et al., 2011) (c) Perception of learning skills (problem solving/ inquiry skills, collaborative skills (Wei & Chen, 2006; Sánchez & Olivares, 2011; Song, 2014); (d) Metacognitive strategies (White, 2006; Lan et al., 2009; Liu et al, 2009) and (e) Self-efficacy and the local culture identity (Sung et al., 2013).

Some of the studies did the assessment across two or three timings, 12 studies (33%) assessed students learning process and skills during mCSCL practices, 8 studies (22%) assessed students' learning after the mCSCL practices; while 5 studies (14%) assessed students' learning in all range of timing (before, duration and after), 5 studies (14%) did the assessment during and after mCSCL practices, 5 studies (14%) did the assessment before and after the practices, and 1 studies (3%) did not present the assessment with adequate evidence.

How was the assessment conducted among the participants of the 35 studies for mCSCL practices? Two forms of measurement were identified: individual about group and group as a whole. Some of the studies employed both of the forms to assess mCSCL practices (see Figure 8). About 15 studies (43%) assessed collaboration via group as a whole; 10 studies (28%) assessed collaboration via individual about group and group as a whole studies, and 9 (26%) assessed collaboration via individual about group, and one study (3%) did not show clearly how collaboration was assessed.

3.4 Research question (3): Have these assessment measures examined the effectiveness of mCSCL that the studies have intended to assess?

Premised on the “Analysis framework and analysis process of mCSCL studies” (see Figure 2) developed in this study, research question (3) was addressed by (a) grouping the assessment measures adopted in these studies with the timing of the assessment (Gress et al., 2010) resulted from research questions (1) and (2), and (b) contextualizing the 35 eligible studies by referring to the results obtained from context of studies.

3.4.1 Grouping the measures with timing of measurement

First, the 7 types of assessment measures that were adopted in 35 studies for 88 times were grouped together with the timing of the measurement. The frequency of measures is shown in Table 2.

Table 2: Frequency of assessment measures adopted in the 35 mCSCL studies categorized by the measurement of timing

Measure type	Measurement timing									Total	
	Before			During			After			n	% N
	n	% n*	% N**	n	% n	% N	n	% n	% N		
Self report	3	25%	3%	0	0	0	13	33%	15%	16	18%
Interviews	0	0		0			11	28%	12%	11	12%
Observations				13	36%	15%				13	15%
Process data				14	39%	16%				14	16%
Discussions & dialogues				6	17%	7%				6	7%
Performance and products	9	75%	10%				15	37%	17%	24	27%
Feedback				3	8%	4%	1	2%	1%	4	5%
Total n	12	100%	13%	36	100%	42%	40	100%	45%	88	100%

*% n = Percentage of assessment measures in each type of timings (before, during, and after)

**% N = Percentage of assessment measures among all types of timings (before, during, and after)

Before mCSCL practices, it is noted from Table 2 that only 12 assessment measures (13% of the total measures) were adopted before the mCSCL practices. The measures mainly concentrated on

using *performance and products* (10%) to assess prior domain knowledge and collaborative skills; while 3% of the studies used *self report* to assess student satisfaction/attitude/perception towards learning system/tool and baseline information about self-efficacy and the local culture identity.

During the mCSCL practices, it is found that 36 assessment measures (42% of the total measures) were used, among which, 13 measures (15%) used observation, 14 measures (16%) used process data followed by 6 measures (7%) of discussions and dialogues and 3 measures (4%) of feedback. These measures were used to assess collaborative behaviors/ patterns, metacognitive strategies, process of collaborative investigations, participation in collaborative activities and affordances and limitations of collaborative learning system/tool.

After the mCSCL practices, it is observed that 40 assessment measures (45% of the total measures) were used, among which, 13 measures (15%) adopted self-report and 11 measures (12%) used interviews, 15 measures (17%) used performance and products and 1 measure (1%) used feedback to assess: learning performance, student satisfaction/attitude/ perception towards learning system/tool, perception of learning skills such as problem solving/ inquiry skills, collaborative skills, metacognitive strategies, and self-efficacy and the local culture identity.

3.4.2 Contextualizing the 35 eligible studies

The assessment measures of all the 35 studies were examined in their own context of studies as well as the timing and form of the assessment. It is observed that there was a fairly low number of assessment measures (13%) that were conducted before the mCSCL practices and a comparatively high number of measures (45%) that were administered after the mCSCL practices although 44% of the 35 studies adopted experimental designs. This indicates that the majority of the experimental studies only tested students' collaboration after their mCSCL practices. In addition, the measures adopted before mCSCL practices focused mainly on performance or collaborative skills' indicators. No studies assessed students' readiness to collaborate which was considered important for fruitful communication (e.g., Gress et al., 2010). On the other hand, it was found that the majority of the 35 studies (21 studies, 60%) had the sample sizes ranging from 10-50, and 2 studies (5%) only had the sample sizes smaller than 10. Thus, the significance of the results from assessment before and after mCSCL practices was challenged.

Next, it is noted that although 42% of the total assessment measures were employed during mCSCL practices, the intervention duration tended to be too short, ranging from 1 day to 4 weeks among 48% of the total 35 studies although all the concerned studies reported positive results. This poses challenge against the sustainability of the collaborative process in these studies in the long run. In addition, many of the studies were lack of a clear coding framework and chose only short episode of the process data. Thus, the objects of assessment were ambiguous.

3.5. Research question (4): What issues do the methodological approaches have in existing mCSCL studies?

This research question was addressed based on the results from the first 3 research questions as well as the analysis framework (see Figure 2). Seven issues of the methodological approaches were pinpointed and summarised in the following seven aspects.

3.5.1 Lack of measures before mCSCL practices

The results of the review study revealed that only a small number of studies conducted assessment before the mCSCL activity, and the assessment measures before mCSCL practices were confined mainly to prior knowledge or skills, and students' perception/attitude towards the collaborative learning system or tool. The form of assessment was restricted to individual about group.

3.5.2 Lack of measures of examining mCSCL processes

Although less than half of the 35 studies conducted assessment during the mCSCL activity and assessed collaboration via group as whole, the types of measures were limited largely to interview, observation, process data and discussion and dialogues. The descriptive approach, if being used properly for fine-grained analysis, can provide rich pictures of interactions (Stahl, 2006). However, in many cases,

only short episodes of collaborative discussion data were selected for the analysis without clear coding schemes, the process of collaboration could not be clearly revealed, and sometimes the objects of measurement were vague. In addition, few studies adopted multiple assessment measures to examine and triangulate the results of interactions.

3.5.3 Domination of results from assessment measures after mCSCL practices

Almost half of the assessment was administered after the mCSCL activity. This implies that the results of the assessment could show only students' individual products or outcomes within groups instead of providing a picture of the overall structure of flow of the group communication, or how individuals contribute to this process (Hmelo-Silver & Bromme, 2007). Therefore, students were not able to witness their collaborative learning process, identify problems and be an active agent to improve their learning.

3.5.4 Short interventions and small sample sizes

Almost half of the studies did the assessment after the mCSCL practices and reported the improvement of collaborative performance and the positive attitudes towards the collaboration. However, it is observed that many of these studies had short interventions with a small sample size. This triggers the doubt whether the positive results reported after mCSCL practices were contributed to "novelty effect" (Thornton & Houser, 2005, p. 224), or "the Hawthorne effect" (Swan et al., 2005, p. 110); and whether the results of the assessment were significant with such a small sample size.

3.5.5 Lack of replication and sustainability of mCSCL research

Because many of these mCSCL studies tended to fall into the category of trials and pilots (Looi et al., 2012) without fine-grained details for assessment and without multiple types of assessment measures, it is hard for these studies to be replicated in future mCSCL research, hence, it is even harder to be sustained.

3.5.6 Domination of in-class planned learning environments in the research design

In all the 35 eligible studies, 85% of them were conducted in "in-class planned learning environments" (65%) or "out-of-class planned environments" (20%); and 63% of all studies used the mobile devices as a collaborative learning system or tool in the collaborative process. This suggests that students' learning processes were driven and evaluated by the learning system or tool use in predefined learning environments.

3.5.7 Lack of the "mobility" nature of mCSCL practices

The most noticeable phenomenon found in this review is that in all the reviewed studies, the "mobility" nature of mCSCL practices was not adequately addressed from the lens of seamless learning (Wong & Looi, 2011). According to Looi et al., 2012, mCSCL practices does not simply mean "mobile + CSCL", it indicates the changing practices that "mobile" technologies have contributed to in continually re-constructed contexts and instantaneous nature of collaboration (Looi et al., 2012). This, in turn, implies that opportunities for student immediate mCSCL would make more knowledge generation possible, and further encourage active participation in the learning activity. However, in many of the studies, the context of student studies tended to be confined in fixed physical classrooms. Few studies attempted to assess collaborative learning across individual and social, physical and virtual and formal and informal learning simultaneously. Also, in the majority of the studies, the mobile devices were provided by schools or institutions, which hinder students' own exploration of the device to support their learning and make students feel lack of ownership of their learning (Song, 2014).

4. Conclusion and future research

This study conducted a systematic review of on the methodological approaches among the 35 eligible mCSCL studies, focusing on assessment of mCSCL. An analysis framework was developed to address four research questions regarding what assessment measures have been adopted, when the assessment measurement had been administered, whether the assessment measures are effective and what methodological issues are discovered. The research findings show that seven assessment measures were employed to assess the 11 types of objects of assessment, and the timing of assessment spread across before, during and after mCSCL practices. By grouping the assessment measures with the timing of assessment premised on the analysis framework and contextualizing the reviewed studies, it was found that in many cases, the measures might not be able to assess what the studies have intended to assess effectively. Seven issues of methodological approaches were pinpointed.

The review study brings to light the following potential directions for further mCSCL research:

- (a) Focus on using multiple assessment measures across different assessment timings (before, during and after the mCSCL activity) in the design of mCSCL research (Gress et al., 2010; Hmelo-Silver & Bromme, 2007);
- (b) Provide clear coding framework and objects of assessment to evaluate the process of collaboration in fine-grained detail (Hmelo-Silver & Bromme, 2007; Stahl et al. 2006);
- (c) Design research with longer interventions and larger sample sizes to make the research results more robust;
- (d) Adopt the method to deal with big data (e.g., learning analytics) to make the students visualise their collaborative learning process and guide them in the learning process with the ultimate goal of optimising their collaborative knowledge construction and developing collaborative skills; in the meantime provide opportunities for teachers to identify problems for pedagogical decision making (Long & Siemens, 2011);
- (e) Design research in which students' collaboration distributes in different spaces (e.g., formal and informal, and virtual and physical learning spaces) using their own mobile devices with existing applications rather than using designed learning systems or tools; and
- (f) Lay emphasis on investigating into viable and novel methodological approaches that address how to capture students' collaborative process and outcomes in the mobile, reconstructed contexts. For example, Hakkarainen (2009) proposes using mobile devices for contextually and repeatedly sampling students' knowledge practices in their natural context to examine students' intellectual and emotional processes at personal and collective levels. This is related to the triological approach which emphasizes collaborative development of mediating objects or artifacts students' worked on rather than monologues within mind (the acquisition view) or dialogues between minds (the participation view) (Hakkarainen & Paavola, 2009). By doing so, we can understand better how students' construct and advance their knowledge in seamless learning environments, and important pedagogical implications can be uncovered in mCSCL practices.

Acknowledgement

The study was funded by Hong Kong Institute of Education under MIT Small Research Grant (*Ref. MIT/SRG09/13-14*).

References

- Coffield, F., Moseley, D., Hall, E., & Ecclestone, K. (2004). *Learning styles and pedagogy in post-16 learning: A systematic and critical review*. London: Learning and Skills Research Centre, Institute of Education.
- Cortez, C., Nussbaum, M., Woywood, G., & Aravena, R. (2009). Learning to collaborate by collaborating: a face-to-face collaborative activity for measuring and learning basics about teamwork. *Journal of Computer Assisted Learning*, 25(2), 126-142.
- Gao, F., Luo, T., & Zhang, K. (2012). Tweeting for learning: A critical analysis of research on microblogging in education published in 2008-2011. *British Journal of Educational Technology*,

43(5), 783-801.

- Gress, C. L. Z., Fior, M., Hadwin, A. F., & Winne, P. H. (2010). Measurement and assessment in computer-supported collaborative learning. *Computers in Human Behavior*, 26(5), 806-814.
- Hakkarainen K. (2009). A knowledge-practice perspective on technology-mediated learning. *International Journal of Computer-Supported Collaborative Learning*, 4, 213–231.
- Hakkarainen, K., & Paavola, S. (2009). Toward a dialogical approach to learning. In B. Schwarz, T. Dreyfus & R. Hershkowitz (Eds.), *Transformation of knowledge through classroom interaction* (pp. 65-80).
- Hmelo-Silver, C. E., & Bromme, R. (2007). Coding discussions and discussing coding: Research on collaborative learning in computer-supported environments. *Learning and Instruction*, 17(4), 460-464.
- Hmelo-Silver, C. E., & Barrows, H. S. (2008). Facilitating collaborative knowledge building. *Cognition and Instruction*, 26(1), 48-94.
- Laru, J., Järvelä, S., & Clariana, R. B. (2012). Supporting collaborative inquiry during a biology field trip with mobile peer-to-peer tools for learning: a case study with K-12 learners. *Interactive Learning Environments*, 20(2), 103-117.
- Long, P. and Siemens, G. (2011). Penetrating the fog: analytics in learning and education, *EDUCAUSE Review*, 46(5), 31–40.
- Looi, C.-K., Wong, L.-H., & Song, Y. (2012). Discovering mobile Computer Supported Collaborative Learning. In C. Hmelo-Silver, A. O'Donnell, C. Chan & C. Chinn (Eds.), *The International Handbook of Collaborative Learning* (pp. 420-436). New York: Routledge.
- Motiwalla, L. F. (2007). Mobile learning: A framework and evaluation. *Computers & Education*, 49(3), 581-596.
- Nussbaum, M., Alvarez, C., McFarlane, A., Gomeza, F., Claro, S., & Radovic, D. (2009). Technology as small group face-to-face collaborative scaffolding. *Computers & Education*, 52, 147-153.
- Roschelle, J., Rafanan, K., Bhanot, R., Estrella, G., Penuel, B., Nussbaum, M., et al. (2010). Scaffolding group explanation and feedback with handheld technology: impact on students' mathematics learning. *Educational Technology Research and Development*, 58(4), 399-419.
- Ryu, H., & Parsons, D. (2012). Risky business or sharing the load? – Social flow in collaborative mobile learning. *Computers & Education*, 58(2), 707-720.
- Song, Y. (2014). "Bring Your Own Device (BYOD)" for Seamless Science Inquiry in a Primary School. *Computers & Education*, 74, 50-60.
- Stahl, G. (Ed.). (2002). *Computer support for collaborative learning : foundations for a CSCL community*. Mahwah, NJ Lawrence Erlbaum Associates, Inc.
- Stahl, G., Koschmann, T., & Suthers, D. D. (2006). Computer-supported collaborative learning: a historical perspective. In R. K. Sawyer (Ed.), *Cambridge handbook of the learning sciences* (pp. 406-427). New York, NY: Cambridge University Press.
- Swan, K., van't Hooft, M., Kratcoski, A., & Unger, D. (2005). Uses and effects of mobile computing devices in K-8 classrooms. *Journal of Research on Technology in Education*, 38(1), 99-112.
- Thornton, P., & Houser, C. (2005). Using mobile phones in English education in Japan. *Journal of Computer Assisted Learning*, 21(3), 217-228.
- Wong, L.-H., Boticki, I., Sun, J., & Looi, C.-K. (2011). Improving the scaffolds of a mobile-assisted Chinese character forming game via a design-based research cycle. *Computers in Human Behavior*, 27(5), 1783-1793.
- Wong, L.-H., & Looi, C.-K. (2011). What seems do we remove in mobile-assisted seamless learning? A critical review of the literature. *Computers & Education*, 57, 2364-2381.

Designing and Developing Interactive Video Experiences to Support M-Learning

Dan KOHEN-VACS^{a, b}, Marc Jansen^a, Marcelo Milrad^a, Miky RONEN^b

^a *CeLeKT, Linnaeus University, Sweden*

^b *Holon Institute of Technology, Israel*

mrkohen@hit.ac.il

Abstract: In recent years, teachers have started to conduct pedagogical activities to promote different kinds of learning interactions supported by rich media. The deployment of such activities is rapidly increasing, as teachers and students own technological means that allow supporting them along such interactions. These activities can be carried out in traditional classroom settings while using regular computers. Additionally, they can also be conducted from anywhere at any time while using smartphones and tablets. In this paper, we describe a pedagogical activity requiring students to author and later peer- assess learning interactions incorporated to videos in YouTube. We describe EDU.Tube, an environment that enables them to create, share and consume such rich media learning activities across a variety of devices. We then detail a plan for the implementation of an activity that took place in 3 different classes dealing with diverse materials addressing computer science related topics. Finally, we also provide an evaluation presenting students' insights and feedbacks resulting from the experienced activity. We discuss and analyze these outcomes in order to elaborate on them as concerns that could be applied for the further deployment of the EDU.Tube environment.

Keywords: Interactive Video, mobile, EDU.Tube, Mobile Learning

1. Introduction

Nowadays, mobile technologies are used to support numerous types of social interactions practiced for different purposes including among others entertainment and education (Taylor, 2010). These interactions supported by mobile technologies provide alternative ways that can be used for different purposes and in different situations. In an educational context; teachers and students use smartphones in order to actively participate in educational activities enriched by multimedia content that could be experienced from anywhere at any time (Parsons, 2013). For example, students participating in field trips could use mobile technologies in order to participate in a challenging learning activity taking place outdoors.

Mobile applications rely on complex but open technological infrastructures. Current standardizations and specifications among these infrastructures enable a vast utilization of common mobile services supported by a diverse number of end user devices (Godhwani, 2013; Mohammad and Tomberg, 2013). Compatibility and adaptability of mobile devices become crucial aspects while considering the development of mobile learning applications that can be executed by the wide variety of mobile devices owned by teachers and students (Cochrane & Bateman, 2010).

The implementation of learning activities supported by mobile rich media also relies on the ability of designers and programmers to cooperate in order to cope with technical, as well as usability related challenges (Saifudin et al., 2012). One possible way to address those challenges is by adopting programming techniques that incorporate libraries and modules supporting application development for mobile technologies. These modules and libraries may address issues related to design challenges across various types of hardware and software settings. In addition, these types of techniques may enable a wide degree of versatility and agility aiming to provide compatibility with various mobile platforms. Developmental processes aimed for these technological settings must also refer to hardware related conditions like computational abilities and network availabilities. In addition, this kind of

developmental efforts should also consider the context in which the mobile applications are being used (Sotsenko et al., 2013). Last but not least, mobile related conditions have to address the display size across devices (Marcotte, 2010; Giemza and Jansen, 2011).

The mentioned above deployment approach could be achieved by the implementation of programming and description languages addressing various types of mobile platforms. Practically, HTML5, CSS3 and JavaScript libraries can support the development of mobile applications. These can later be integrated, compiled and shared as web environments adapted to various type of devices having different operating systems. These developmental efforts are applicable for mobile and educational environments aiming to provide ubiquitous learning experiences enhanced by mobile rich media.

Learning supported by web and mobile technologies is becoming more feasible because students may own more than one device adequately used for a certain purpose (Moran et al., 2010). For example, students may be required to participate in a range of learning activities that can take place across different locations. Such activities may begin outside the classroom and may require students to interact with portable and small-scale devices like smartphones. Furthermore, students may continue with some of their learning interactions in regular classes while practicing a more traditional way of learning (Bollen, 2010).

In this paper, we present a learning activity consisting of different type of interactions supported by various types of web and mobile technologies. This activity has been implemented and tested with 75 students attending courses at bachelor and master level in two different academic institutions. We briefly describe the EDU.Tube environment used to provide technological support for the enactment of this learning scenario. Specifically, we used EDU.Tube to enable authoring, sharing and displaying of digital videos that incorporate educational interactions used along this activity. We then describe how educational interactions authored by students were later offered to their peers as appealing learning opportunities. We also identify various design and development challenges reported by teachers and students providing crucial information to be considered for the further improvement of the tool. Finally, we suggest a set of recommendations that could later be used to guide an advanced and refined version of EDU.Tube.

2. Motivation

Teachers and developers could join forces while aiming to design and enable learning activities supported by technology that include educational videos available on the web (Lindeberg, 2011). Such developmental challenges should address the composition of various and interrelated pieces of media aiming to provide a meaningful learning experience. In this respect, developers and designers may require to cope with interrelated visual aspects containing information communicated by teacher or students. These aspects include the composition and arrangement of information to be represented by various types of media. Developers should also deal with functionalities related to the user interface addressing the control over the flow of such media.

We aimed to cope with some of the previously described challenges while designing and developing an educational and interactive video environment called EDU.Tube (Kohen-Vacs et al., 2013). This environment is accessible from various types of mobile devices using their existing web browsers. Teachers and students may use EDU.Tube in order to author various types of interactions related to specific moments in occasional video found in YouTube. These videos and their related synchronized interactions could be later offered to students as innovative and appealing pedagogical opportunities.

One of the objectives of this paper is to provide an evaluation of the EDU.Tube technology following its implementation in a pedagogical activity described in a later section. This evaluation was conducted according to a Technology Acceptance Test (TAT) based on the Technology Acceptance Model (TAM) (Davis et al., 1989). TAM sets a theoretical framework that aims to show how users accept technology and also addresses factors that may influence the adoption of innovative technological solutions. This model postulates that the use of an information environment is influenced by the behavioral intention is determined by the person's attitude towards the use of the system. Attitude refers both to the aspects representing the perceived usefulness of a system and the perceived ease of use of such a system. Furthermore, the model claims that there is a direct relation between the ease of use and the usefulness of such system.

We addressed the perceived usefulness and the perceived ease of use as defined in this model in relation to EDU.Tube. We suggest that the incorporation of such a model could be used as a tool to assess educational experiences provided by EDU.Tube, as well as to enable future refinements of these activities potentially providing improved educational experiences. This assessment includes an examination of pedagogical aspects as communicated while been supported by EDU.Tube. Moreover, we specifically examine different aspects of such experience as supported by the different technologies been used. One of the assumptions in our assessment is that web and mobile technologies may directly influence the learning environment's functionalities, as reflected from its user interface. In the next section, we described the pedagogical scenario in which we have tested and validated our ideas.

3. Pedagogical Scenario

The learning activity described in this section was designed for undergraduate and graduate university students learning essential terms in the field of computer science. The activity was technologically supported by the EDU.Tube authoring environment enabling students to convert occasional YouTube videos into interactive educational opportunities. The activity includes a phase in which students are required to author interactions related to YouTube videos. This phase is followed by another one in which these interactions are peer assessed (Kohen-Vacs, et al., 2013). The learning activity consists of three complementary and interrelated phases as described in Figure 1.

The activity commences while students are requested to seek for regular videos available on YouTube that could potentially be related to the subject matters dealt in the courses. These video resources are later incorporated with interactions aiming to foster students' understanding of the learned topics (Gilroy, 2010). Such educational strategy implemented in this activity aims to develop students' ability to associate and use authentic problems by using video examples related to the subject matter presented in the courses. The actual enactment of this activity required the use of another technological environment called Collaborative e-Learning Structures (CeLS) enabling to author, enact and reuse different types of multiphase and collaborative pedagogical strategies (Ronen, 2010). The integration of the CeLS environment enabled the orchestration of participants into the assignments demanded from students.

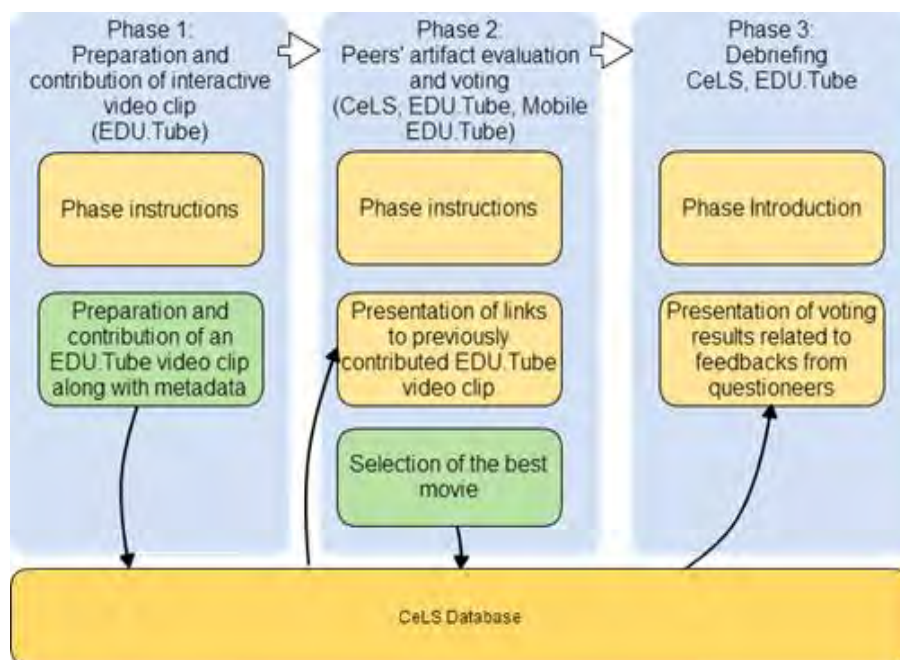

Figure 1. Description of learning Activity's interrelated phases

Below, we describe the goals of each one of the phases, its required educational interactions and the technologies used for their accomplishment:

- Phase 1- *Preparation and contribution of an interactive video clip*: During this phase, students are presented with a specific topic in the field of computer science. Later on, they are requested to search for a short video on YouTube, which could be used as a pedagogical opportunity for exploring and learning the topics under study. The students are requested to use the EDU.Tube authoring environment in which they import the link to a video with a length between three to five minutes. Students are required to enrich this video by three to five interactions along its time line aiming to convert it to an interactive video that could potentially be used as a learning opportunity. In this phase students play the role in which they incorporate interactions to a video with the EDU.Tube authoring environment that should only be used with a stationary environment.
- Phase 2- *Peers' artefact evaluation and voting*: Before the actual initialization of this phase, all the interactive videos and their corresponding metadata are integrated into the CeLS database creating a repository of students' artefacts created in EDU.Tube. This integration aims to provide students with an opportunity to assess the content of the interactive videos contributed by their peers using their own regular, tablet or smartphone computing device independently from their physical and geographical context. These assessments are registered in the CeLS environment and provide teachers and students with the option for further elaboration. During this phase, each student is presented with seven videos created by his/her peers and he/she is asked to vote for the three best videos. In addition, students are asked to textually justify their selections.
- Phase 3 *Debriefing*: During this phase the teacher conducts a debriefing session including the presentation of example videos which were previously contributed by the students for the competition enacted during the second phase. The teacher presents the most selected videos (as a result of the peer assessment) while emphasizing its attributes that potentially can transform it to a learning opportunity that could be reused in the future.

In the following section we provide a description of the EDU.Tube environment used to support the enactment of the described scenario.

4. Environment's Description

As mentioned earlier, the EDU.Tube environment offers support for the authoring of educational interactions to be synchronized and incorporated into YouTube videos. The authoring process of such interactions could be initiated by teachers or students seeking for a YouTube resource that can later be used as an educational opportunity. The link to such video is submitted and played by EDU.Tube. The playback of this video is visually represented by a marker that advances along the timeline of the submitted clip. An author may choose to incorporate an educational interaction at any point along the timeline. This process is done by choosing a desired moment of interaction followed by the selection of the requested type of educational interaction. An author may choose to incorporate various types of interactions like an attention point presenting students with important additional information. In addition he/she may choose different types of questions including open text, single or multiple selections.

Figure 2 illustrate an example of a video incorporated with a single choice type of interaction along a meaningful positive feedback.



Figure 2. Incorporation of an interaction for a computer science lesson technologically supported by EDU.Tube

Interactive videos can be shared by students and later be used by them on their regular computers, smartphones or tablet devices. These videos can also be shared by students while using different communication channels like regular mail, social networks or the Learning Management Systems (LMS). We mentioned before that the type of device from which a learner consumes an educational service might represent a key factor for providing an optimized pedagogical experience.

Figure 3 illustrates the process in which EDU.Tube detects the type of device from which the student consumes a video and accordingly adapts the content presentation to the used device.

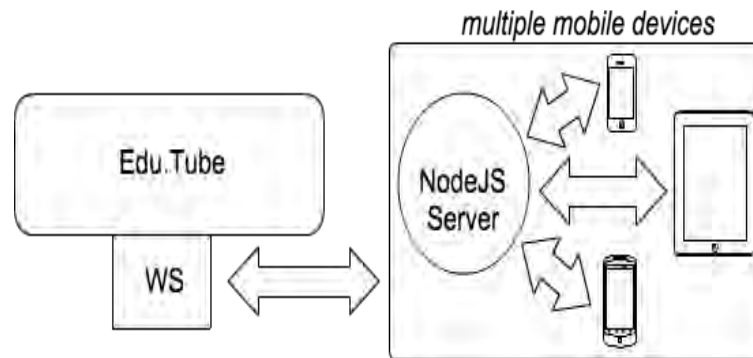

Figure 3. EDU.Tube’s content is adapted and communicated to different type of devices

5. Activity Evaluation

In this section, we provide the results of an evaluation based on a questionnaire presented to students. This evaluation was conducted with 75 students participating in a learning activity following the ideas described in section 3 and supported by EDU.Tube. This activity took place during one semester in 2013 in the context of three courses dealing with introduction to procedural programming, advanced topics in server side programming and software engineering.

First year students of a bachelor degree in instructional technologies attended the introductory course. The second course dealt with server side programming and was attended by second year students of the same program. The third course dealt with software engineering and was attended by first year students of a computer science study program. The number of participants in the introduction course was 27, while 21 participants attended the server side course. The software engineering course also included 27 participants.

Table 1 presents the availability of different technological devices among students, its use for educational purposes while interacting with EDU.Tube. In some cases, students own and use more than one type of device.

Table 1: Technological availability and use of EDU.Tube across courses

Course		Procedural programming	Advanced topics in server side programming	Software engineering
Category				
Participants		27	21	27
Use rate of technological devices for studying purposes	Regular	37%	28%	56%
	Laptop	88%	86%	74%
	Mobile	23%	52%	30%
	Tablet	0%	0%	30%
Use rate of EDU.Tube on regular or laptop computers		67%	61%	78%
Use rate of EDU.Tube on smartphones or tablets		33%	33%	19%

As already mentioned, we evaluated the activity with a questionnaire that included a section addressing the type of technology owned by students. In addition the questionnaire also addressed the pattern of use for these technologies, the perceived added value of EDU.Tube, the preferred device to be used with such environment, the reasons for these preferences and finally a request for student's

impressions, insights and comments about their overall experience. As previously described, this learning activity included three phases in which students had the opportunity to author educational interactions according to an occasionally found and selected YouTube video. These interactions were later consumed and assessed while using various types of technologies. The first part of the questionnaire addressed the variance of technological devices owned by the students. We checked the availability of stationary, laptops, tablets and smartphones among the students and found that 42 students have stationary computer, while almost all of the students reported to have a laptop computer. In addition, 62 students reported to have a smartphone device while a minority of them (17) reported to have a tablet device. In the majority of the cases the students had both; one major computing device and one small mobile or tablet device. In this respect, we found that 47 students that reported to have a laptop and a smartphone.

The subsequent question addressed the patterns in which students used information technologies while experiencing learning. Almost all the students reported to use their laptop devices while studying. A closer look at the data revealed that in the software engineering course the students used almost all their available technologies while in the introductory course only 22% of the class participants used smartphones. We also checked the use of technology among students attending the advanced server-side programming course and found that 50% of the participants in this course used smartphones.

The next questions addressed EDU.Tube's perceived added values. We addressed a question related to EDU.Tube in general without mentioning specifically its instances (mobile or regular). 70% of the students found that the EDU.Tube activities presented by the teacher after each lecture helped them to some extent to deepen their understanding of the learning materials. A closer look at this data reveals that only a minority of 29% of the students felt that the activity was 'very' or even 'very much' helpful. We then asked the students to specify their preferred instance of EDU.Tube. 69% of the students reported that they would prefer using EDU.Tube on their laptop devices while only 28% of them reported to have no specific preference. Almost none of the students preferred to use the environment exclusively on his smartphone device.

In the next questions, we requested to specifically write down the reasons for which students preferred a specific instance of the technological platform. Most of the commenting students pointed out the lack of convenience for using such an application in a smartphone with a small screen device. The next question in this group referred to the level of user friendliness of the environment. In this respect, we discovered that almost all the students reported that the regular version of the EDU.Tube is user friendly while almost all of them reported that the mobile instance of the environment's interface is difficult to use. We then closely examined the specific reasons for which they indicated their preferences and impressions. Many of the students pointed out that there is a prominent challenge while using small-scale devices for interactions that combine videos along with textual media. Some of the students specifically stated that there is a need to re-arrange these media before experiencing it on a small-scale display.

Some students also commented about the nature of the interaction incorporated to the video. In this respect, they mentioned that for some situations they prefer to continue their video experiences without the disruption typically involved in interactive videos. Furthermore, in some of the cases the students even mentioned that they prefer watching the video fluently while aiming to gain a good idea of the whole content without disruptions. This recommendation included a suggestion for a 1st round of a non-interactive video followed by a second in which the interactions will be presented. Another concern of the students involved the requirement for meaningful feedback and being given credit for the activity. They wondered if the results from their participation were accumulated and they even recommended to re-route students to different learning paths according to a reasoning mechanism based on accumulated history of interactions.

Finally, there were a small minority of students that reported operational issues with mobile phones like problems connecting to the network, lack of compatibility to some mobile operating systems and a very few operational bugs in the environment's mechanism. The final question required students to openly state their comments including aspects of the system that they thought that requires further improvement and other aspects they already found satisfactory. In this section of the questionnaire, students re-stated all points for improvement that they provided previously while they reaffirmed their desire to keep using an improved versions of EDU.Tube. Specifically, they reported

that they liked the pedagogical approaches encompassed with interactive videos provided by a relatively user-friendly environment.

6. Conclusions and Future work

In the previous section we have presented and analyzed some of the students' insights followed by their experiences using the EDU.Tube environment. These impressions also described their preferences while considering the use of EDU.Tube from a stationary or mobile device accordingly supported by a proper instance. We also presented their prominent comments and recommendations related to their learning process supported by web and mobile technologies. In this section, we summarize the outcomes as reflected from the TAT questionnaire based from TAM. We also offer our vision for the next version of the mobile instance of EDU.Tube that aims to provide a better user experience supported by improved data arrangement. The results as summarized from the questionnaire indicate that students were willing to accept and recognized the added value of educational and rich media activities combined within their regular learning process. Students identified some of the challenges related their educational experience supported by mobile environment.

One of the main comments addressed by the students, concern interface and technical related aspects of the mobile instance of EDU.Tube. Students pointed out that due to operational and compatibility issues, the environment might not be operational. EDU.Tube, thus, might not be useful across the different devices owned by students. Another operational concern involves the lack of systems' ability to auto restart videos following a user interaction. Such constraint enforces students using the mobile instance of EDU.Tube to commit a manual operation in order to continue interacting with the video clip. This way of operation is originated from a security restriction existing across the smartphones' operating systems. Such challenge could be worked around while presenting students with a meaningful announcement reminding them to reinitiate the playback of the video

One of the most challenging aspects of the environment concerns the requirement for re-arrangement of the user interface aiming to organize and display all relevant media in a convenient composition at the correct instance. In the current mobile version, the appearance of the interactions is detached from the corresponding video while sometimes the details in the video may provide important visual information needed for the student's interaction. Figure 4 illustrates a video reaching the point of interaction (on the left) and then is completely disappearing in order to present the interaction (on the right).



Figure 4. A video and its interaction as displayed in a mobile device

In this case, the implementation of mobile adapted web design could offer a set of approaches aiming to properly represent information in mobile displays.

During the implementation presented in this paper, we used EDU.Tube as a technological tool that provides support for authoring and using interactive videos combined into a multiphase collaborative learning activity. In this implementation we used EDU.Tube's API in order to share information between the EDU.Tube's database and the mobile instance of the environment. This information includes data indicating the location of the resource in YouTube and its synchronized interactions. Such a type of activity may require addressing different aspects related to the orchestration of educational interactions. These aspects may include the place, time, location and technological mean in which these interactions are achieved (Dillenbourg, 2011). In this sense, the contextualized use of technology may require further development of EDU.Tube APIs. These APIs might be required in order to enable teachers to integrate EDU.Tube to additional pedagogical strategies requiring the authoring or use of interactive videos along other related learning tasks.

Feedbacks and insights provided by the students revealed important aspects to be considered in terms of the pedagogical enactment of a rich media used in an educational activity. Those addressed pedagogical, logistical, design and technological interrelated aspects. These aspects point out the requirement for adaptation of educational materials aimed to be consumed on mobile technologies. Specifically, teachers have to consider that students that access educational materials on their mobile devices may experience the learning process anytime and beyond the boundaries of the traditional classroom. In such cases, students could consume an educational activity remotely from their teacher and therefore may not be able to be provided with immediate support both at a pedagogical level, as well as at the operational level. Teachers may require anticipating such type of challenges and coping with them while selecting and incorporating specific mobile activities to their pedagogical strategies. In addition they might consider providing dedicated means of scaffolds and meaningful feedbacks along the educational activity. Another aspect related to the teacher, concerns adaptations required for activities having rich media learning materials. These adaptations need to address the consumption of rich media on diverse type of technological devices. In addition, such adaptations need to address the possible adoption of regular materials to be used on mobile platforms enabling a better exploitation of educational materials consumed ubiquitously (Kukulska-Hulme & Traxler, 2013). Specifically, these adaptations may provide students with a more meaningful learning process while they consume learning materials along a pedagogical process enacted across context. Both educational and technical concerns will be used to guide future deployments of advanced versions of EDU.Tube. We aim at better coordinating techno-pedagogical efforts accordingly practiced by different type of stakeholders.

Despite the mentioned comments, students still showed a positive attitude and enthusiasm for participating in such future activities supported by EDU.Tube's mobile instance. Students expressed their willingness to try future versions while aiming to exploit additional and more advance features of the environment. Our future efforts will focus on developing a process that allows a better cooperation between the various stakeholders including teachers, designers and developers aiming to improve the deployment of such environment supporting multiphase collaborative learning activities. We will examine the establishment of an agile design and development approach offering a convenient framework that enables each of the stakeholders to concentrate in different aspects of the development process. The actual implementation of such an approach might provide a convenient way to deploy pedagogical strategies supported by different technologies providing an improved used interface. Specifically, we aim towards developing an approach that might enable the representations of educational interactions across different end-user devices properly adapted to a context of use. This approach is also related to the design of learning flows and their corresponded orchestration according to the modeled pedagogical strategy.

Acknowledgements

We would like to thank Natalie Orbach, Idan Ben-Ari and Adi Silagy for their participation in the design and development of the EDU.Tube environment.

References

- Bollen, L. (2010). *Activity structuring and activity monitoring in heterogeneous learning scenarios with mobile devices*. (Vol. 9). Hamburg: Verlag Dr. Kovac..
- Cochrane, T., & Bateman, R. (2010). Smartphones give you wings: Pedagogical affordances of mobile Web 2.0. *Australasian Journal of Educational Technology*, 26(1), 1-14.
- Davis, F. D. (1989). Perceived usefulness, perceived ease of use, and user acceptance of information technology. *MIS quarterly*, 319-340.
- Davis, F. D., Bagozzi, R. P., & Warshaw, P. R. (1989). User acceptance of computer technology: a comparison of two theoretical models. *Management science*, 35(8), 982-1003.
- Dillenbourg, P., Zufferey, G., Alavi, H., Jermann, P., Do-Lenh, S., Bonnard, Q., & Kaplan, F. (2011). Classroom orchestration: The third circle of usability. *CSCL2011 Proceedings*, 1, 510-517.
- Giemza, A., & Jansen, M. (2011). An architectural approach to support multi-device learning environments. In *Proc. of the IADIS International Conference on Mobile Learning* (pp. 319-321).
- Gilroy, M. (2010). Higher education migrates to YouTube and social networks. *Education Digest*, 75(7), 18-22.
- Godhwani, P. B. (2013). A research paper on SEO aid in mobile website optimization. *International Journal of Management, IT and Engineering*, 3(6), 282-288.
- Kohen-Vacs, D., Jansen, M., & Milrad, M. (2013). Integrating Interactive Videos in Mobile Learning Scenarios. *QScience Proceedings*, (12th World Conference on Mobile and Contextual Learning [mLearn 2013]).
- Kukulka-Hulme, Agnes and Traxler, John (2013). Design principles for mobile learning. In: Beetham, Helen and Sharpe, Rhona eds. *Rethinking Pedagogy for a Digital Age: Designing for 21st Century Learning* (2nd ed.). Abingdon: Routledge, pp. 244–257..
- Lindeberg, M., Kristiansen, S., Plagemann, T., & Goebel, V. (2011). Challenges and techniques for video streaming over mobile ad hoc networks. *Multimedia Systems*, 17(1), 51-82.
- Marcotte, E. (2010). Responsive web design. *A list apart*, 306.
- Mohammad, A. S., & Tomberg, V. (2013). Harnessing the Potential of Accessibility Standards and Responsive Web Design Practices to Achieve Learning Interoperability on the Level of the User Interface. In *Advances in Web-Based Learning–ICWL 2013* (pp. 294-305). Springer Berlin Heidelberg.
- Moran, M., Hawkes, M., & El Gayar, O. (2010). Tablet personal computer integration in higher education: Applying the unified theory of acceptance and use technology model to understand supporting factors. *Journal of Educational Computing Research*, 42(1), 79-101.
- Parsons, D. (2014). The future of mobile learning and implications for education and training. In M. Ally & Tsinakos, A. (Eds.), *Increasing access through mobile learning* (pp.217-229). Vancouver: Commonwealth of Learning & Athabasca University.
- Ronen, M., & Kohen-Vacs, D. (2010). Modeling, enacting, sharing and reusing online collaborative pedagogy with CeLS. *Techniques for Fostering Collaboration in Online Learning Communities: Theoretical and Practical Perspectives*, IGI Global, 319-339.
- Saifudin, W. S. N. S., Salam, S., & Abdullah, M. H. L. (2012). Multimedia mobile content development framework and methodology for developing M-Learning applications. *Journal of Technical Education and Training*, 4(1), 15-21.
- Sharples, M., Taylor, J., & Vavoula, G. (2010). A theory of learning for the mobile age. In *Medienbildung in neuen Kulturräumen* (pp. 87-99). VS Verlag für Sozialwissenschaften.
- Sotsenko, J., Jansen, M., & Milrad, M. (2013). About the Contextualization of Learning Objects in Mobile Learning Settings. *QScience Proceedings*, (12th World Conference on Mobile and Contextual Learning [mLearn 2013]).

Feeling at Home from the First Day: Using Mobile Location-Based Games for Welcoming New Students

Miky RONEN, Ronen HAMMER and Dan KOHEN-VACS

Department of Instructional Technology, Holon Institute of Technology (HIT), Holon, Israel

ronen@hit.ac.il, ronenh@hit.ac.il, mrkohen@hit.ac.il

Abstract: New students' orientation events in Higher Education typically focus on information delivery (rules, duties, procedures, etc). Consequently, new students might feel overwhelmed, lonely and anonymous. Our study describes an attempt to take advantage of the mobile technology available to all for conducting an active orientation event that addresses students' needs for safety and belonging and focuses on their emotional experience rather than on information delivery. The main activity during the event was a "treasure hunt" game played throughout the campus, using students' personal smartphones. The game was developed with Treasure-HIT, an authoring system that enables the design of location based games and activities operated by mobile devices. At the end of the first day of their studies (a week after the orientation event) students who participated in the event and students who did not, described their feelings regarding the new beginning. The psychological wellbeing of the students who participated in the orientation event seemed to be markedly higher than those who did not: they felt more at home, with a better sense of orientation in the campus and a sense of belonging, having already formed friendships. The findings suggest that team location-based games supported by mobile technology may efficiently support the adjustment and socialization of new students. The paper further describes the scaling-up potential of Treasure-HIT based orientation activities as manifested in spontaneous self-directed adoption of the system for supporting similar events conducted in schools.

Keywords: treasure hunt, location based game, mobile learning, orientation, scaling-up

1. Introduction

Orientation programs in higher education are meant to facilitate students' transition from previous settings (e.g. high school, workplace) to the academic culture (Upcraft and Farnsworth, 1984; Ward-Roof, 2010). Initial induction programs are of particular importance since they set the tone and build students' expectations for consequent orientation and socialization processes (Shobrook, 2003). First meetings and organizational introduction events typically focus on the delivery of information and on technical and procedural contents. Students typically feel anonymous and isolated during such events, experiencing an overload of information.

Yet, in recent years some organizations recognize the flaws of 'information-only' introductions and try to create events that are highly emotional and experiential (Tyler, 1998; Lines, 2011). Being experiential, such events are memorable (Buchanan, 2007) and might even reduce turnover (Hacker, 2004). Similarly, some Universities and Colleges realize that besides providing information, induction to higher education should address students' needs, particularly those related to psychological security and a sense of belonging (Billing, 1997; Carter and McNeill, 1998; Maslow, 1954).

An example of such a 'student centered' induction approach is reported by Poblete et al. (2006) who describe the orientation program at the school of engineering in the University of Chile. The activity took place during two days, a week before the beginning of the semester. The new students participated in a series of challenging activities which encouraged them to get to know one another, become familiar with the campus, and get a better notion of the challenges they will be facing as engineers. The impact of this experience was assessed by a questionnaire administered after the induction. Participants' replies (80% of the cohort) were compared to non-participants (20% of the

cohort) and to second year students which did not participate a year before in an induction event. The comparison revealed a positive impact of the induction experience on participants' well-being, their sense of belonging, closer relationships among peers, and trust on the school of engineering's commitment to teaching.

The recent availability of advanced mobile technology offers new opportunities for extending instructional activities beyond the traditional boundaries of the classroom (Giemza, Verheyen and Hoppe, 2012; Sébastien and Audrey, 2011) and attempts to adapt them to different kinds of outdoor and indoor spaces (Kukulaska-Hulme and Traxler, 2005; Sung et al., 2010). Several studies suggested taking advantage of this technology for coping with the challenge of supporting the orientation of new students arriving to an unfamiliar campus.

Curran and Huang (2008) describe an attempt to assist overseas students' induction to campus using mobile technology for providing web based multilingual information about locations and services that may be useful to students who do not master the local language. In this study the mobile technology was offered on demand, only as an information platform.

Coping with the goal of actually engaging participants in an activity strongly suggests using a gamification approach. Schwabe and Göth, (2005) designed a gaming supplement for the traditional orientation rally, a fun event intended to get to know the university and its surroundings. The rally led all participants through relevant sites in the campus with several tasks to carry out at certain spots. The MobileGame added to the rally was operated with small handheld computers provided by the university. The students played a 'hunting and hiding' game against each other, individually or in small groups. Fitz-Walter, Tjondronegoro, and Wyeth (2012) describe an effort to design a mobile application, based on gamification principles, that was meant to deal with students' reports (derived from previous orientation events) of feelings lost, having trouble meeting new friends and finding what services and events are available on campus. The gaming element was based on achievements: the players gained scores by completing challenges such as finding locations, answering informational questions about campus services and facilities, adding phone numbers of new friends and checking-in to relevant events. The scores for each set of challenges were presented on a leaderboard and students who completed a set could enter a draw for prizes (iPad 2 and gift vouchers). The game was conducted during a period of four weeks including the orientation week. Challenges could be updated and changed in the application during the game period using a web-based Content Management System.

The mobile games described in these studies were based on dedicated environments especially designed and developed for supporting orientation on new students in the specific campuses. Our goal was to explore the possibility to adapt a generic game approach and system for supporting students' activities during orientation events, in order to enable easy adoption by any institution.

One of the classical approaches to location-based learning is Treasure Hunt type games. In such games, participants are challenged to identify specific sites according to clues and to physically reach these sites. Additional activities could be assigned at the sites as a condition to advance in the game. Mobile technology can provide direct support for such games by tracking participants' locations in real time, presenting the game clues in various multimedia formats, enactment of pre-planned interactive activities related to the sites, collecting and sharing digital information contributed by the participants, communication among participants and between them and the game's instructor, and controlling the activity by the game manager. Various types of mobile treasure hunt environments were developed in order to create such games for different purposes (Spikol and Milrad, 2008; Hooper and Rettberg, 2011).

In this study we used the Treasure-HIT system (Kohen-Vacs, Ronen and Cohen, 2012) for creating and enacting a mobile game for welcoming new students, while taking advantage of the personal mobile technology (smartphones) available to all. In the following sections we shall briefly introduce the Treasure-HIT system, describe the design of a Welcome game and its implementation with students and present the results of the evaluation study. We shall then describe the first phases of the scaling-up of this approach as it is adopted by system users in other institutions.

2. Designing a Mobile Game with Treasure-HIT

Treasure-HIT (Kohen-Vacs, Ronen and Cohen, 2012) is a system designed to enable teachers to easily create educational location-based games operated via mobile devices. The system includes two components: an authoring web environment for creating and controlling the game and the players'

application used by the participants for game enactment. The application is currently available for iPhones and Android.

In a game created with Treasure-HIT the players (teams or individuals) are challenged to identify specific sites (stations) according to clues provided by the game creator and to physically reach these locations. When arriving to a station, the players have to complete a series of tasks. The clues directing to the next station will appear only upon completion of all tasks. The game mechanism automatically discourages random guessing while repeated incorrect answers to the same task will result in a delay penalty.

A game may include any number of outdoor and indoor stations. The interface for defining a station is shown in Figure 1.

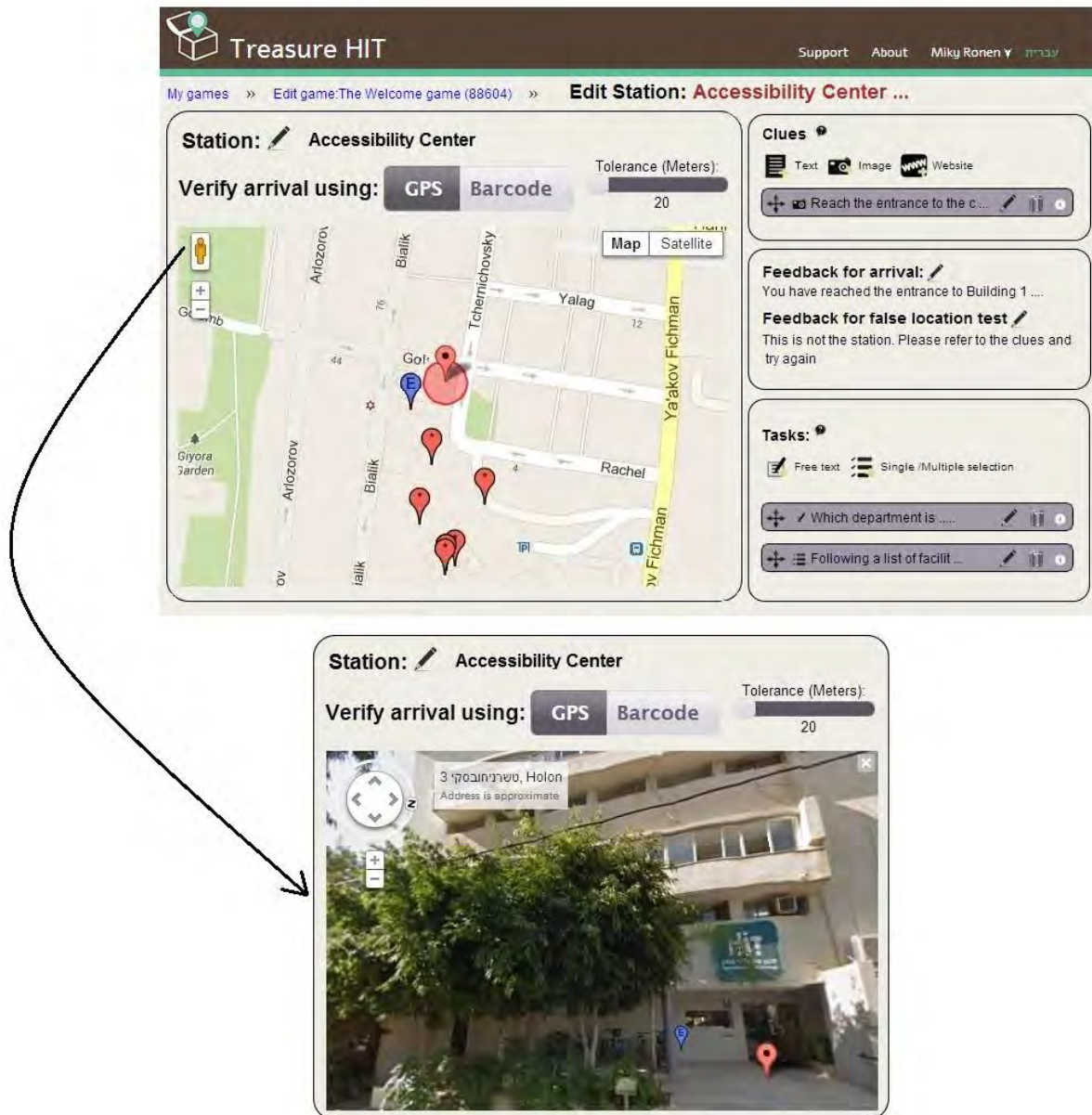

Figure 1. The author interface for defining a station – an example from the Welcome game.

This interface allows the author to control all the information and actions related to the station:

- The type of arrival confirmation. Arrival to outdoor stations would be confirmed by activating the device's GPS. The Barcode option is available for defining indoor stations. The Barcode is automatically created by the system to be placed on site.
- The clues that will direct players to the station presented as a combination of any type of media (text, picture, movie clip or link to website).

- The location of the station. The location of an outdoor station is set via a simple web interface that embeds Google Maps API by positioning the marker on the map. Further position refinement could be achieved using Google StreetView API, when available (lower part of Figure 1). The author can control the minimal required distance from the site (Tolerance) in order to accommodate to the limitations of the GPS technology.
- The feedback provided upon arrival to the station.

The tasks to be performed at the station, presented as multiple choice or open questions, or as activities to be performed that will result in receiving a confirmation code.

The game creator can define the sequence of the stations as identical to all players or as different, with a common end station. In the case of different sequences, the order of the stations presented to each team would be automatically determined by the system to provide paths with similar lengths. More advance setting allow the game creator to allot only part of the stations to each team, for example, in a game that includes 20 stations each team would be directed only to 7 of them. This option is useful for designing games that are played simultaneously by a large number of teams, in order to minimize the chance that teams would arrive to the same station at the same time.

3. The Welcome Game

The orientation event was conducted one week before the beginning of the 2014 academic year. 41 of the 70 new students that enrolled to an undergraduate program in "Instructional Technologies" attended the event. The event started by presenting the Welcome game as a competition between teams. The participants were asked to form groups of 3-4 then take several minutes for an initial personal introduction within the group and define a name for their team. One member in each group was instructed to install the Treasure-HIT application on his smartphone and the groups started playing.

The game included eight stations spread throughout the campus (Fig. 1), four located outdoors and four indoors. The order of stations assigned to each group was different while all shared the same ending point near the lecture hall where game results were presented.

At each station the team was presented with a set of tasks aimed to familiarize them with specific facilities and services provided at this site, especially focusing on aspects relevant to new students (Fig. 2). In order to complete the tasks the participants had to examine the physical location, to look for specific information published on site or online. Some of the tasks did not have straight forward answers and the team members had to discuss the options and to apply their judgment.

One of the challenges we faced was identifying the most relevant content for new students. In order to cope with this challenge we have involved the second year cohort and asked them to propose locations and issues that would be especially relevant for "newcomers". Many of the 20 proposals suggested by the sophomores were indeed used in the final version of the game.

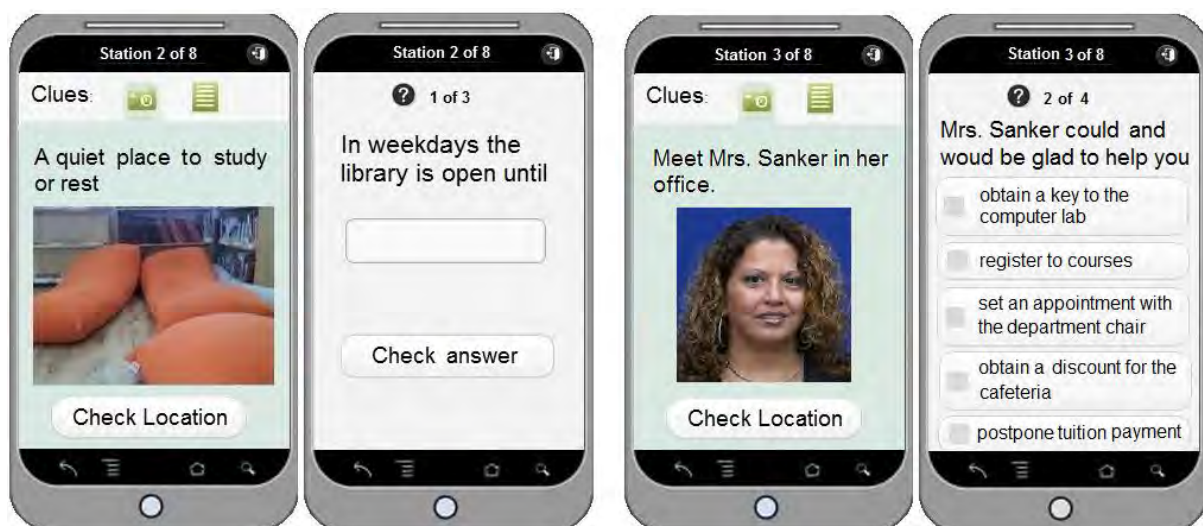

Figure 2. Examples of clues directing to stations and of simple tasks presented at the stations.

4. Results and Analysis

This section summarizes the evaluation study aimed to assess the efficacy of the mobile game, as the first stage of introducing students to their new environment. The evaluation was based on:

- The game records saved in the system's database.
- Reports provided by six observers. Three of the observers accompanied sample teams during the whole game and the others documented the activity occurring at specific stations.
- Data collected by questionnaires filled in by all freshmen at the end of the first school day.
- Sample interviews with students.

The observers reported that the participants were highly engaged in the game and tried all possible strategies in order to identify the locations and successfully complete the tasks, including approaching staff in offices and other students in the campus. Lively discussions were held on issues that were addressed by some of the tasks (Figure 3).



Figure 3. Students playing the Welcome game.

Ten of the eleven groups that started the game completed it in about 40-50 minutes. The game results (Figure 4) were presented to the participants as part of a short summary session of the event.

Results Wellcome Game (29.9.2013)						
#	Team	Start	Stations	Time	Location Err.	Content Err.
1	Mebulbalim	18:17	8	00:46:02	1	4
2	Girl power	18:21	8	00:47:15	2	6
3	Tipulit	18:21	8	00:49:26	0	8
4	Habanot	18:10	8	00:49:02	9	3
5	Bazmanshela	18:18	8	00:42:25	4	7
6	Hamushpaim	18:15	8	00:54:51	7	4
7	Milkis	18:17	8	00:43:05	2	11
8	Segal	18:24	8	00:49:25	9	1
9	Blimaam	18:17	8	00:55:52	4	5
10	Hattemim	18:16	8	00:49:10	7	14
11	No name	18:20	6	---	7	5

Figure 4. The game results

At the end of the first school day (a week after the orientation event) all 70 first year students filled in a questionnaire expressing their feelings as new students. The students were asked to grade their level of acquaintance with peers, familiarity with the environment, sense of belonging and level of anxiety on a 1-9 scale.

A significant correlation was found between the reported sense of belonging and the level of acquaintance with peers ($R=0.5$, $p<0.01$) and the familiarity with the campus environment ($R=0.45$, $p<0.05$).

40% of the students in new cohort did not attend the orientation event and have not participated in the game. Fig. 5 present the comparison between the reported feelings of the students who participated in the game and those who did not.

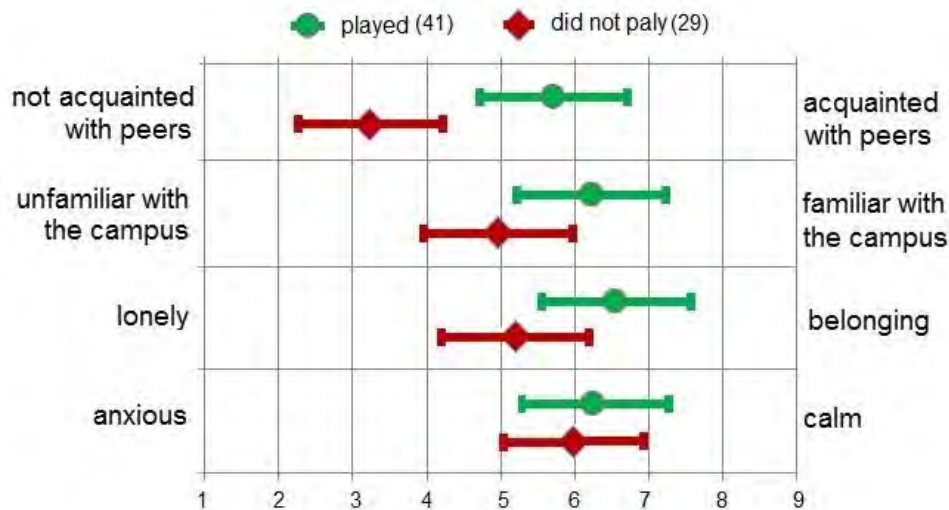

Figure 5. Students' reported feelings at the first day

The findings (Table 1) clearly indicate that the students who participated in the game felt more familiar with the campus environment and more acquainted with their new peers, therefore less lonely with a higher sense of belonging.

Table 1. Analysis of differences in students' feelings

<i>Feeling</i>	<i>t (df=68)</i>	<i>Sig. (2-tailed)</i>
Anxious - Calm	.520	nsd
Lonely - Belonging	3.56	.001
Unfamiliar - Familiar with the campus	2.53	.014
Not acquainted - Acquainted with peers	5.01	0.000006

In addition, the students who took part in the orientation event were also asked to reflect on the game they have experienced a week ago. The questionnaire was anonymous but the students were asked to specify the name of their game team. Only 3 of the 41 students could not remember the name of their team. The students reported that the game was enjoyable, relevant and useful, helped them get familiar with the campus and with their new peers (Figure 6).

The social impact of the game was also clearly evident in the way the students' were seated in lecture hall at the end of the first school day. More than 60% of the students who participated in the orientation event were seated next to one of their team members in the game.

In the open part of the questionnaire students were asked if any of the information they have been exposed to during the game was memorable or surprising. Students mentioned specific details that they have learned during the activity about places in the campus, services and facilities that they have been exposed to. The aspect that was mentioned as surprising by many was the very fact that the event was conducted as a game: "We did not expect such a thing, but a boring lecture ..."

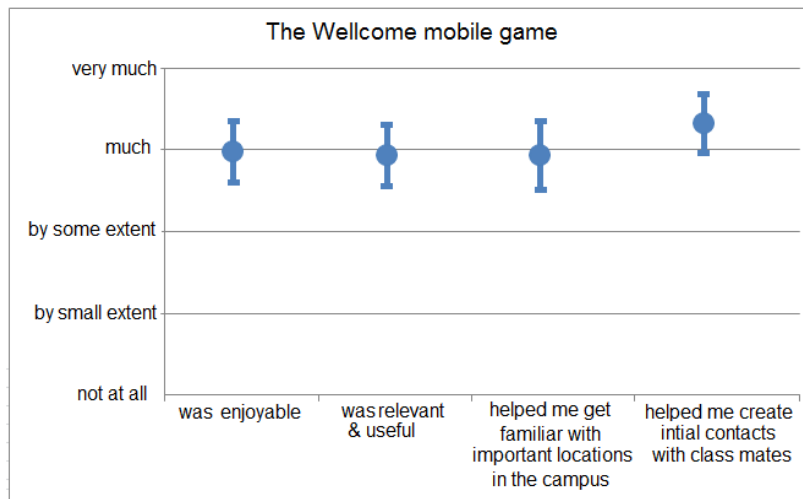

Figure 6. Students' evaluation of the game (N=41)

As described at the beginning of this section, the game results were presented to the participants at the end of the game. Since the students acted quite competitively during the game and the presentation of the results seemed to be very meaningful for them, it was interesting to check whether the personal evaluation of the game was related to their success represented by the relative ranking of their team. The analysis of students' responses indeed revealed that students whose team has achieved a higher ranking evaluated the game as more enjoyable ($R = 0.36$, $p = 0.027$).

The findings confirm that even a relatively short mobile location-based game can have a meaningful positive impact on new students' feeling of belonging, and to support their "feeling at home" from the first day. We intend to use updated versions of this game in future orientation events of our department and to support other departments and institutions in developing their own games.

5. Mobile Welcome Games - Anyone Can Adopt and Adapt

The Treasure-HIT environment was originally designed to enable teachers to easily create mobile games that would support location-based learning conducted outdoors and indoors. The system is already used by a growing community of teachers representing a variety of disciplines.

After exposing the model of the Welcome game described in the previous sections to the community of Treasure-HIT users, we are witnessing a trend of adopting this approach for conducting orientation events in schools. The mobile location based games are designed independently by the school team and adapted to the specific needs of institution and of the target audience of the event. Orientation events in elementary schools involve parents and kids while at junior-high level and higher, the activity is usually addressed only to the new students. Some schools piloted the game they have developed as a team formation activity for the school staff. These initiatives suggest that when a useful tool such as Treasure-HIT meets a relevant need (i.e., meaningful and experiential orientation events) spontaneous and self-directed scaling-up might occur.

An "extreme" version of such a game was recently conducted in an elementary school (Figure 7). In this case, the goal was not only to familiarize parents and kids with the school environment and facilities but also to fully support the whole process of registration to the next school year.

The clues directed teams of parents and kids to 9 stations, located indoors and outdoors throughout the school. At each station they were presented with simple tasks introducing the function and facilities offered at the site or the staff member responsible of the site. For some stations the task included activities required for the registrations process: At the school secretariat the parents enrolled their kids, the computer lab was used to fill in the necessary forms and the arts lab to prepare the kid's photos for the school records.



Figure 7. A Welcome game in an elementary school – parents and kids.

According to the school principal: *"The idea was not only to acquaint parents and kids with the school environment but to also transform a rather boring bureaucratic process performed individually to a playful and social event. All parents and kids enjoyed the event and even parents that were already familiar with the school reported that they have learned new things about the place during the game".*

6. Concluding Remarks

Experiences of beginnings and endings, in many cases, leave a lasting imprint in our memories (Strongman & Kemp, 1991). Memories of entering first grade, attending college, our first job, our first love, are among the strongest and most accessible autobiographical memories we dispose. Universities and other organizations have an opportunity to influence people joining them, at a relatively rare moment, where they are quite receptive, in a state of emotional arousal, with a need to get away from feelings of loneliness, disorientation, and anonymity.

Location-based games, that take advantage of the mobile technology available to all, have the potential of rapidly creating a sense of inter-group cohesiveness, acquaintance with the physical environment and with organizational functions and key persons. As a result, such activities can effect participants' psychological wellbeing and ensure a smoother beginning in a new place.

Authoring environments like the Treasure-HIT support easy creation and enactment of such activities. However, the activities should be carefully designed. It is crucial to identify the locations and organizational functions that are particularly relevant to the participants and to be selective in presenting contents in order to avoid information overload. The tasks should help expose participants to critical information, and at the same time, maintain a high level of motivation by being challenging and sophisticated.

Indeed, from an instructional design perspective designing an effective game involves using motivational strategies such as obtaining optimal levels of challenge and curiosity, collaborations and competition (e.g., Lepper & Malone, 1987). However, treasure hunt games seem to involve additional psychological aspects. Similar to hide and seek games (e.g. Vollmer, 2009), part of the excitement of playing the game might be related to 'finding concealed stuff' – which might be associated to psychological themes of separation and reunion. In addition, treasure hunt games might have the flavor of quest-tales or coming-of-age stories where the protagonist has to be smart and resourceful and handle a set of challenges in order to complete an important task (e.g., Bettelheim, 1976). In other words, the Treasure-HIT environment is but a tool. The quality of the game, like any other pedagogical quest, depends on the designer's ingenuity and his intuitions regarding the target audience's needs and desires.

Our future efforts will focus on refining the Treasure-HIT authoring system by adding the ability to perform 'social tasks' and providing documented guidance to users for developing their own welcome games.

Acknowledgements

Thanks to the Treasure-HIT project team Shavit Cohen and Guy Sakal for the technological assistance, to Noga Lavi for supporting the implementation and documentation of this study.

References

- Bettelheim, B. (1976). *The Uses of Enchantment: The Meaning and Importance of Fairy Tales*. Random House, New York.
- Billing, D. (1997). Induction of new students to Higher Education. *Innovations in Education & Training International*, 34(2), 125-134.
- Buchanan, B.W. (2007). Retrieval of Emotional Memories. *Psychological Bulletin*, 133(5), 761–779.
- Carter, K. & McNeill, J. (1998). Coping with the darkness of transition: Students as the leading lights of guidance at induction to higher education. *British Journal of Guidance and Counseling*, 26(3), 399-415.
- Curran K., & Huang, W. (2008). A multilingual mobile university information portal designed to cater for visiting overseas students. *Interactive Technology and Smart Education*, 5(1), 4-28.
- Fitz-Walter, Z., Tjondronegoro, D., & Wyeth, P. (2012). A gamified mobile application for engaging new students at university orientation. In *Proceedings of the 24th Australian Computer-Human Interaction Conference*(pp. 138-141). ACM.
- Giemza A., Verheyen P., & Hoppe H.U. (2012). Challenges in Scaling Mobile Learning Applications: The Example of Quizzer. *IEEE International Conference on Wireless, Mobile, and Ubiquitous Technology in Education*, 287-291.
- Hacker, C.A. (2004). New employee orientation: make it pay dividends for years to come. *Information Systems Management*, 21(1), 89-92.
- Hooper, C.J. & Rettberg, J.W. (2011). Experiences with Geographical Collaborative Systems: Playfulness in Geosocial Networks and Geocaching. In: *Please enjoy workshop at Mobile, HCI*.
- Kohen-Vacs, D., Ronen M. & Cohen, S. (2012). Mobile Treasure Hunt Games for Outdoor Learning. *Bulletin of the IEEE Technical Committee on Learning Technology*, 14(4), 24-26.
- Kukulska-Hulme, A., & Traxler, J. (2005). *Mobile Learning: A Handbook for Educators and Trainers*. Great Britain: The Cromwell Press.
- Lepper, M.R. & Malone, T.W. Intrinsic motivation and instructional effectiveness in computer-based education. In R.E. Snow and M. J. Farr (Eds.), *Aptitude, Learning and Instruction III: Conative and Affective Process Analyses*. Hillsdale, N.J.: Erlbaum, 1987.
- Lines, E. (2011). *Innovative strategies for effective induction*. Retrieved from: <http://www.line.co.uk/forum-reports/innovative-strategies-for-effective-induction/>
- Maslow, A (1954). *Motivation and personality*. New York, NY: Harper.
- Poblete, P., Young, W., Selis, S., Palma, R., Verdugo, R., Foncea, C., Gherardelli, C., Avilez, R., Ramírez, M. (2005). Active induction of first-year students at the university of Chile. Fifth international workshop on Active Learning in Engineering Education. 8-11 June 2005, Holland.
- Sébastien, G., Audrey, S., (2011) Introducing Mobility in Serious Games: Enhancing Situated and Collaborative Learning. In: J.A. Jacko (Ed.): *Human-Computer Interaction, Part IV*, HCI.
- Shobrook, S. (2003). The role of Pre Entry Practices and Induction Strategies in relation to Student Retention. The University of Hull, U.K., Progress Guide No 10. *Contextualising the problem and case studies in induction strategies*. Retrieved from: <http://www.hull.ac.uk/engprogress/Prog3Papers/Sarah1.pdf>
- Spikol, D., & Milrad, M. (2008). Physical activities and playful learning using mobile games. *World Scientific Publishing Company & Asia-Pacific Society for Computers in Education*. 3(3), 275–295.
- Strongman, K. T., & Kemp, S. (1991). Autobiographical memory for emotion. *Bulletin of the Psychonomic Society*, Vol. 29(3). 195-198.
- Sung, Y.T. Hou, H.T. Liu C.K. & Chang, K.E. (2010). Mobile guide system using problem-solving strategy for museum learning: a sequential learning behavioral pattern analysis. *Journal of Computer Assisted Learning*, 26, 106–115.
- Schwabe, G., & Göth, C. (2005). Mobile learning with a mobile game: design and motivational effects. *Journal of computer assisted learning*, 21(3), 204-216.
- Vollmer, S. (2009). Hide and seek: Why do we leave? Why do we want to be found? *Psychology Today*, Dec. 23rd, 2009. Retrieved from: <http://www.psychologytoday.com/blog/learning-play/200912/hidden-and-seek>
- Tyler, K. (1998). Take new employee orientation off the back burner. *HR Magazine* 43(6), 49-57.
- Upcraft, M.L., & Farnsworth, W.E. (1984). Orientation programs and activities. In Upcraft M.L. (Ed.), *New directions for student services: Orienting students to college* (pp. 27-37). San Francisco: Jossey-Bass.
- Ward-Roof, J.E. (2010), (Ed.) *Designing successful transitions: A guide for Orienting students to college*, 3rd Ed., National Orientation Directors Association.

How Do Students Progress in a Mobilized Inquiry Science Curriculum

Chee-Kit LOOI, Daner SUN, Wenting XIE, Chun Ming TAN*, Siti HAJAR*

National Institute of Education, Nanyang Technological University, Singapore

**Nan Chiau Primary School, Singapore*

cheekit.looi@nie.edu.sg

Abstract: There is abundant research reporting the designs of ubiquitous and seamless learning environments which are enabled by the integration of mobile technology. However, the lack of pedagogical designs that provide for sustainability, and the inadequate investigations of learning outcomes are some of the major gaps in current studies. Towards addressing these issues, this paper describes a study that illuminates the principles of how mobile learning can be integrated into a standard-based science curriculum, and explores how this mobilized curriculum impacts students' performances in and out of the classroom. Data analysis on students' test results, learning artifacts and their activity performances in the classroom suggested that they improved in conceptual understanding and self-reflections on conceptual changes. Students were engaged in mobile learning activities both and out of the classroom based on sustained exposure to and experiences of the mobilized science curriculum.

Keywords: Mobile Learning, Pedagogical Design, Science Curriculum, Conceptual Understanding

1. Introduction

With advances in smartphone technology, the use of smartphone has become pervasive and ubiquitous in many modern societies. Recognizing the multiple functions of the smartphone and its educational value, educators have long advocated the adoption of mobile learning in schools (Ng & Nicholas, 2013; Song, 2014). Research on technological design, pedagogical design, and implementation and evaluation of smartphone-enabled learning (or mobile learning in a broad sense) has been accumulating, yet challenges remain in supporting teacher enactment and obtaining evidence of student learning in mobile learning (Looi, et al, 2014). A review of current studies on mobile learning reveals the dearth of reported longitudinal studies. Few studies have explored the impact of sustainable mobile learning programs that are at the curriculum level on student learning performance. The existing evidence is too scarce to inform future research and practices concerning mobilized school-based teaching and learning. Thus, it is necessary and significant to conduct a longitudinal study that develops pedagogical design principles on how to integrate mobile learning into a standardized science curriculum, and that traces the trajectory of students' performance progression throughout the learning process. This paper presents such a study focusing on exploring student performance change brought about by a mobilized science curriculum. The principles of integrating mobile learning into the standardized science curriculum will be introduced, and the findings of students learning performance in mobile learning activities will be reported and discussed. Implications will be drawn to inform the design and implementation of mobile learning.

2. Literature Review

In addition to the integration of suitable mobile technologies, how to combine appropriate pedagogical strategies for enhanced learning application has been a critical issue in mobile learning research (Jeng, et al., 2010). It has been extensively discussed that the design of mobile learning activities should be, like the design of any other learning activity, driven by specific learning objectives (Sharples, et al., 2009). Researchers have placed increasing emphasis on establishing pedagogical principles based on the attributes of the mobile learning environment configured for teaching and learning. For instance, a pilot study on mobile experiential learning created a new way of inquiry-based mobile technology

integration in science learning: in-class questioning, out-of class field trip observation, on site reflection, hands-on experimentation, and learning artefact creation, and sharing and evaluation (Song, Wong & Looi, 2012). Relevant studies on ThinknLearn, Mobile Plant Learning System, Mobile Tour System, and nQuire generated positive impact on both teachers and students, and highlighted the integration of appropriate pedagogical principles supported by technology design (Ahmed & Parsons, 2013; Jones, Scanlon, & Clough, 2013; Huang, Lin, & Chang, 2011; Ruchter, Bernhard, & Geiger, 2010;). These studies affirm the potential of mobile learning in enriching science education. More importantly, evidence has been obtained for supporting the claim that combining mobile learning systems/apps and appropriate pedagogical approaches (e.g. inquiry-based principles, knowledge building, collaborating learning) can create special educational value for students' science learning.

Studies that discussed the use of mobile phones for delivering course materials, learners' preparedness for and usage of the mobilized form of learning, and learners' satisfaction level and learning experiences abound. Yet none of these studies are directly related to the use of mobile phones for academic purposes (Lee, 2013). Sustainable mobile learning programs that are designed for teaching and learning standardized curriculum are rare. To further improve the educational use of mobile technologies, efforts should be made to align and integrate school curriculum into the research design, and thus to improve the balance between research needs and school needs. Moreover, recent mobile learning research emphasizes more on learning in the informal context. Few studies have designed mobile activities that connect learning in both formal and informal contexts. Evidence about the integrated and synergetic effects of linking these two contexts or environments of learning is inadequate (Looi, et al., 2010). As mentioned before, most studies focus on examining short-lived learning experiences and reporting findings based on students' self-reports (i.e. interviews, questionnaires and surveys). Fewer efforts have sought to investigate the learning trajectory of students using mobile technologies for learning over sustained periods of time. To address these issues, we have designed and developed an innovative standard-based science curriculum supported by mobile learning, and explored how this innovation has influenced students' science learning in and out of classroom. This study proposes a mobile learning design that bridges formal and informal learning contexts, and presents new findings of students' performances in the mobilized science curriculum.

3. Research Questions and Purposes

This study was conducted to answer the following research questions:

1. How can we integrate mobile learning into a standard-based science curriculum?
2. What are students' learning progressions in and out of classroom impacted by the mobilized curriculum?

4. Introduction of M5ESC

4.1 M5ESC and MyDesk Learning System

In our project, an innovative science curriculum, namely, Mobilized 5E Science Curriculum has been developed iteratively and progressively via design-based research in Singapore since 2008 (Looi, et al, 2009). It is a first attempt to systematically and comprehensively explore the integration of mobile learning with a science curriculum for long-term, stage-by-stage intervention. The curriculum is mapped to national science curriculum standards, and covers all of the standard materials required in a primary school. Aligning with the Primary Science Syllabus (MOE, 2008, pp. 2-3) and Singapore Ministry of Education (MOE)'s advocacy on the development of 21st century competencies in science education, M5ESC aims to promote students' conceptual understanding and critical learning skills (e.g. collaborative learning skills, self-directed learning skills, reflective thinking skills) (Sha, et al., 2012; MOE, 2010). The lesson design of M5ESC is based on 5E (Engagement-Exploration- Explanation-Elaboration- Evaluation) inquiry principle (Bybee, 2006). It flexibly incorporates mobile apps from a learning system, MyDesk which is a multifunctional tool installed in windows smart phones. The system consists of a teacher module and a student module. Teacher module provides an authoring tool for the teacher to create mobile activities using different learning tools. It also supports teachers to

review, evaluate and retrieve students' learning artifacts after lessons. In the student module, students can access the activities designed by their teacher, construct learning artifacts, and compose self-reflections using the assigned learning tools. The learning tools in MyDesk include KWL (doing self-reflection through responding to “what I Know” and “What I want to know” before and to “what I Learnt” after learning the topic), NotePad (taking notes), Recorder (recording voice), Sketchbook (drawing models), MapIT (constructing concept maps), and Blurb (posing questions). The combination of these tools is intended to facilitate students to develop sophisticated and systematic understanding of scientific concepts, enhance skills in modelling, reasoning and reflective thinking, and foster self-directed learning skills in and out of the classroom (Brooks & Brooks, 2009; Greca & Moreira, 2000). Other supporting tools (e.g., mobile blog, online discussion forum, video/photo camera, and a search engine) are also incorporated for use by students. Students will receive the teacher's rating of and feedback to their learning artifacts once their teacher has done the evaluation.

4.2 Design Principles of Mobile Learning in M5ESC

The designed mobile learning activities aim to fully leverage technological affordances both in and out of classroom, to address different cognitive levels of usage, and to provide the opportunity for teachers to create ubiquitous learning environment that brings together real-world resources and digital world information. Following Starkey's 'Digital Age Learning Matrix' (Starkey, 2011), we propose ways of integrating mobile technology into the standard-based curriculum (Table 1). The main purpose of applying mobile activities is facilitating knowledge construction, as well as developing science inquiry skills.

Level 1 mobile learning activities include the use of NotePad or/and Recorder for collecting data and writing notes in field trips. KWL allows self-reflection on the connections between knowledge; hence it can be integrated into high cognitive levels of activities (i.e. Level 2, 3 and 4). As an animation tool, Sketchbook is used to promote students' ability to connect knowledge with daily experiences, and to develop higher levels of conceptual understanding (i.e. Level 5 and 6) through peer assessment of artifacts. Blurb is generally used to improve students' thinking and reasoning about the concepts through posing questions, which is appropriate for designing Level 2 and 3 activities. Using these apps, students will have more opportunities to participate in different levels of mobile learning activities, and they will construct higher levels of knowledge understanding through doing these mobile learning activities in M5ESC.

Table 1: Proposed cognitive levels of learning activities in M5ESC

Mobile tools	Level 1: Doing	Level 2: Thinking about connections	Level 3: Thinking about concepts	Level 4: Critiquing and evaluating	Level 5: Creating knowledge	Level 6: Sharing knowledge
KWL		√	√	√		
Sketchbook				√	√	√
MapIT				√	√	√
Blurb		√	√			
NotePad	√					
Recorder	√					

The design of M5ESC is aligned with the vision that learning needs to be learner-centered, situated, collaborative, ubiquitous, and continuous. The use of technology has become more personalized, user-centered, mobile, networked, ubiquitous, and durable in M5ESC (Motiwalla, 2007). The incorporation of different tools facilitates blended forms of different learning activities residing in one learning environment (Naismith, et al., 2004). In the M5ESC classroom, the constructivist learning theory supports inquiry by placing the focus of learning on student ideas, questions, and understanding, rather than on teacher delivery of content (Fosnot, 1996). Thus, teachers are encouraged to apply constructivist teaching approaches to ask questions, conduct mobile activities, interact with students, and scaffold students' learning. Equipped with mobile devices, student learning activities can be conducted both in and out of classroom according to the principles of seamless learning (Wong & Looi,

2011); Various patterns of learning activities (e.g. individual inquiry, collaborative inquiry, peer discussion) are mainly designed with the aim of developing students' sophisticated understanding of science, and fostering their self-directed learning and collaborative learning skills. In M5ESC, a substantial amount of time is allocated to doing the mobile learning activities as compared with non-mobile activities. Teachers and students interact more frequently in the discussion and sharing of work generated by mobile tools. As formative assessment is regarded as an integral part of instruction and an important source for students and teachers to make reflections on learning and teaching, students' performance in mobile learning activities, which represent their involvement in the learning process, is identified as an important indicator for assessing their learning gains in M5ESC. In this paper, our focus will be on students' performance both in and out of classroom with the intention of identifying students' progression in the mobile learning activities throughout the long-term intervention.

5. Participants

In the year of 2012, M5ESC was scaled at the whole Grade 3 level in a primary school (P3) in Singapore. The 2012 P3 cohort, 299 Students (aged 10-11) in 8 classes, were participants of this study. The cohort progressed into P4 in 2013. As mobile learning activities were expected as a routine in this school, each student was assigned a smartphone as the mobile learning device and allowed to bring the learning device into and out of classroom. There were 4 teachers teaching the P3 cohort, each in charge of two classes. Since the academic year of 2012, teachers and researchers worked together on a weekly basis to co-design and elaborate the lessons. All teachers performed actively in PD sharing and discussion in weekly teacher-researcher meetings. They had strong willingness to receive feedback on curriculum enactment and to elaborate their teaching strategies. Students and their parents also appreciated the educational value of the smartphone. The parents supported their children to use the smartphone out of the classroom to extend their learning.

6. Data Sources and Analysis

In this project, data collection focused on teacher performance in curriculum enactment, student performance in and out of classroom, and teacher and student responses in MyDesk. Classroom observation was conducted in each class in 2012 and 2013 throughout the whole school year. Field notes were used to record the lesson sequence and key instructional events in the class (i.e. questions, interaction, experiments, and mobile activities); Classroom observation sheet was designed for collecting data on teacher and student performance on the key instructional events; Researchers retrieved and reviewed students' work and teacher feedback in MyDesk to explore student performance (i.e. engagement, concept understanding, reflective thinking) out of classroom. In this study, three sources of data were used for analyzing the progression of students' learning performance:

- 1) SA1 and SA2 results: students' achievement in standard tests. SA1 (Semestral Assessment 1 administered at the end of the first semester) and SA2 (Semestral Assessment 2 administered at the end of the second semester) scores in 2012 and 2013 were compared to provide more evidence for supporting our research hypothesis that students would benefit more in reasoning and conceptual understanding with the implementation of M5ESC. These two examinations were considered as summative assessments of students' achievements in science learning, and the results were used by the school as key indicators to evaluate students' progress over the year. The total score of SA1 and SA2 was 100 marks, with 60 marks for MCQ (Multi-Choice Questions) (2 marks for each item) and 40 marks for OEQ (Open-Ended Questions) (2 marks for each item). As the official and standard tests conducted at the whole level in the pilot school each year, SA1 and SA2 had been reviewed and validated by a group of experienced teachers in the school. The difficulty level of SA1 and SA2 are comparable at the item level. To investigate the reliability of the tests, a mock-up test with items of similar difficulty level and structure was conducted before each standard test. The mock-up test results were analyzed to help revise the inappropriate items.
- 2) MyDesk work: work completion rate and level of work quality. A cross-year comparative study was conducted to uncover students' progression in MyDesk performance. The completion rate of each task was analyzed to investigate students' engagement in mobile learning activities that

occurred out of classroom. The quality level of work produced in KWL, Sketchbook, and MapIT, the activities that had higher completion rate and used more frequently, was identified as the major indicator of students' progression in conceptual understanding and relevant thinking skills

- 3) Students' activity performance in the classroom: student performance in sharing, discussion, and experimentation.

Data analysis was conducted by two researchers, and the inter-rate agreement of MyDesk coding reached 93%.

7. Findings

7.1 Progression in Academic Performance

One-sample t-test (Table 2) was conducted to compare 2012 and 2013 P3 SA1 and SA2 results. The result showed that the whole P3 cohort made a significant increase of 7.69% in total score from SA1 to SA2 ($t = 6.584, p < .05$) in 2012. In 2013, the improvement (10.07%) was also significant ($t = 13.626, p < .05$). In 2012, it was prominent to note that such progress was mainly attributed to their increase in OEQ scores (27.04%) ($t = 11.845, p < .05$) since they experienced a slight (not significant) decrease in MCQ scores. After getting into the second scaling year, P4 students performed as well as the previous P3 students in 2012 in MCQ (6.91%) and OEQ (20.33%).

Table 2. SA1/SA2 HA-MA-LA¹ Gains in 2012 and 2013

School year		MCQ gains	OEQ gains	Total Gains
2012	All	0.49%, $t=.406$	27.04%*, $t=11.845$	7.69%*, $t=6.584$
	HA	-5.04%, $t=-5.987$	11.71%*, $t=7.798$	5.04% , $t=.535$
	MA	0.91% , $t=.595$	29.55%*, $t=8.835$	8.62%*, $t=6.047$
	LA	13.16%*, $t=2.487$	60.30%*, $t=7.071$	23.49%*, $t=4.809$
2013	All	6.91%*, $t=5.978$	20.33%*, $t=18.514$	10.07%*, $t=13.626$
	HA	3.53%*, $t=3.24$	16.30%*, $t=15.021$	7.7%*, $t=10.1$
	MA	10.98%*, $t=5.52$	23.07%*, $t=12.527$	13.86%*, $t=10.643$
	LA	6.41%, $t=1.449$	23.55%*, $t=4.587$	8.03%*, $t=3.198$

*: Statistically Significant

¹ The eight classes were grouped into three ability levels, namely, HA (High Achievement), MA (Mixed Achievement) and LA (Low Achievement) based on their prior achievements at the P1/P2 level.

Specifically, in 2012, the LA group out of the three ability groups, achieved the highest MCQ gains (13.16%) ($t = 2.487, p < .05$), OEQ gains (60.30%) ($t = 7.071, p < .05$) and total gains (23.49%) ($t = 4.809, p < .05$). Additionally, the HA group achieved significant OEQ gains (11.71%) ($t = 7.798, p < .05$) and the MA group achieved significant OEQ gains (29.55%) ($t = 8.835, p < .05$). In 2013, the three ability groups (HA, MA and LA), achieved equal gain. Our analysis showed that most classes had a significant increase from SA1 to SA2 in terms of MCQ scores, OE scores and total scores, except the LA group who did not achieve significant increase in MCQ gains.

In summary, both 2012 and 2013 cohorts had achieved significant gains in total and OEQ scores. The improvement in OEQ scores was the major reason for the improvement of the total score. MA and LA groups attained more SA1/SA2 gains than the MA group, especially in OEQ scores.

7.2 Progression in Mobile Learning Performance

7.2.1 Students' Engagement in MyDesk learning activities

In 2012 P3, MyDesk learning tools were integrated into five science topics: Diversity of plants, Fungi, Materials, System: plants and their parts, and System: digestion. When students progressed into P4, MyDesk learning tools were incorporated into five topics, namely, Cycles, Matter, Interactions, Heat,

and Light. Table 3 shows the results of the average completion rate of these activities using the assigned learning tools in 2012 and 2013. The result suggested that students provided more responses to these mobile activities in 2013/P4 (with an average completion rate of 44.85%) than they did in 2012/P3 (with an average completion rate of 24.09%). Compared to 2012 MyDesk task completion, students in 2013 achieved a high completion rate in KWL, MapIT and Sketchbook activities. In Sketchbook activities, the response rate increased more than 50%. This revealed that students were more engaged in using Sketchbook to describe their understanding and to relate their understanding with their daily life experiences.

Table 3. The comparison of MyDesk activity completion rates in 2012 and 2013

Year	Audio	Blurb	KWL	MapIT	Sketchbook	Notepad	Average Rate
2012	7.25%	23.73%	48.63%	24.42%	24.84%	4.00%	24.09%
2013	-	-	53.44%	36.88%	50.56%	-	44.85%

Paired samples t test indicated the significant difference in usage between different learning tools in 2012, such as between audio recorder and KWL ($t=-7.990$, $p=0.000<0.05$), KWL and MapIT ($t=5.183$, $p=0.000<0.05$), as well as Sketchbook and KWL ($t=5.132$, $p=0.000>0.05$). In 2013, significant difference in usage was also found between KWL and MapIT, and MapIT and Sketchbook. This suggested students' discrepant involvement in different mobile learning activities out of classroom. Students, with different skills, knowledge, and guidance and feedback from their teacher, used different tools to extend their learning. Through this comparison, we got more insights into students' involvement in MyDesk and their levels of engagement in each mobile activity. This also provided valuable information for teachers to improve their design, elaboration, and evaluation of the mobile learning activities for students.

7.2.2 Progression in conceptual understanding

We selected students' artifacts in KWL, MapIT, and Sketchbook (which received higher completion rates) to compare the quality level of the MyDesk work done in 2012 and 2013.

1) KWL Reflection

KWL in MyDesk is organized in three sections:

- What I **know** - refers to student's prior knowledge of the topic/task before the lessons;
- What I **want** to know - refers to student's further thinking about the prior knowledge and the knowledge he/she wants to elaborate in the process of the lessons;
- What I **learnt** - refers to student's self-reflection on the knowledge he/she has learnt about the assigned topic after the lessons.

Data analysis of students' work in KWL in 2012 and 2013 suggested that students not only performed more actively in responding to KWL activities, but also improved their levels of reflective thinking. Compared to the 24.08% completion rate of What I Learnt in 2012, the completion rate of 2013 (which was 41.43%) was high. Moreover, students became more willing to share their prior knowledge (the completion rate of What I Know increased from 33.83% to 56.43%). In 2012, only 20% students completed all the three sections of KWL. In 2013, that figure was doubled (40%). This suggested that more and more students could manage to examine their prior knowledge and identify the new knowledge gained that could help elaborate and extend their prior knowledge. They had gradually developed their thinking skills as they got into P4. They also become more skilful at reflecting their knowledge understanding.

2) Sketchbook Construction

In M5ESC, Sketchbook is used to design out-of-classroom mobile activities for students to connect their knowledge with the daily life experiences. In P4, home-based experiments were designed for

students to observe and record the growth of plants, the lifecycle of mealworm, and the comparison between moist and dry bread. In P3, Sketchbook activities were designed to provide students extensive opportunities to explore the name, properties and value of materials, fungi, heat, and magnets in the surrounding environment. We coded Sketchbook activities into four quality levels modified from the knowledge integration scoring rubric (Linn & Eylon, 2011):

- Level 1 (Non-relative pic/text): Students have irrelevant ideas and make incorrect links with the task.
- Level 2 (Relative pic/text): Students have relevant ideas and make partial correct links with the task.
- Level 3 (Relative pic/text with simple explanations): Students have relevant ideas and make correct links with the task and provide simple explanations.
- Level 4 (Relative pic/text with simple explanations): Students have relevant ideas and make correct links with the task and provide elaborated explanations.

Having analyzed the completed Sketchbook activities, we found that most students responded positively in their work. Their efforts in constructing learning artifacts could be reflected by the pictures they captured in their daily life. We also noticed that some pictures were captured with the assistance from their parents. Figure 1 shows the distribution of the quality levels of students' Sketchbook learning artifacts.

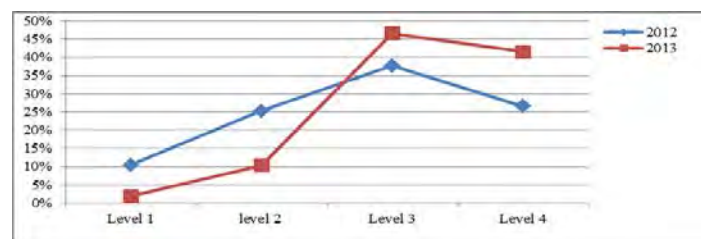

Figure 1. Distribution of the quality levels of Sketchbook activities

Compared to their 2012 performance, students performed well in Sketchbook activities in 2013. The proportion of L3 and L4 artifacts, the high level ones, had increased from 37.68% to 46.53%, and from 26.55% to 41.43% respectively. Meanwhile, the decrease of L1 and L2 work further suggested students' progression in Sketchbook activities. Another interesting finding was students' active participation in doing and recording experiments occurred out of classroom, such as observing the growth of beans, the life cycles of mealworm, and the growth of mould in moist bread. We could summarize that students had developed more interest in observing scientific phenomena in daily life and intended to explain the phenomena observed by applying the new concepts and principles learnt in M5ESC. Our classroom observation provided further evidence for the demonstration of such positive changes. In the classroom, they were more interested in elaborating the artifacts, and would like to share their learning process behind their work with the class and the teacher.

3) MapIT Concept Map

Through reviewing students' concept maps, teachers could obtain full information on the levels of students' conceptual understanding and detect their major misconceptions. In M5ESC, MapIT activities were designed for both 2012 and 2013 science topics with the aim to develop students' system thinking of what they learnt and how each concept related to each other. Based on literature review (Kinchin, et al., 2000; Slotte & Lonka, 1999), we identified three levels of concept maps, which were used to evaluate the quality level of students' MapIT learning artifacts:

- Low Quality: presenting a part of key concepts without relationship links
- Middle Quality: presenting a part of key concepts with a part of correct relationship links
- High Quality: presenting all key concepts with correct relationship links

Reviewing students' concept maps drawn using MapIT, we found students had developed better skills at constructing concept maps with increasing participation in M5SCE. The rate of high level concept maps produced increased from 33.01% in 2012 to 39.35% in 2013. The rate of low level concept maps generated decreased from 8.23% in 2012 to 0.2% in 2013. A considerable number of students intended to present their understanding of the target concepts via drawing complex concepts, or organizing the key concepts together with correct relationship links. The improvement in 2013 suggested that it was possible to develop system thinking skills in students in lower primary grades.

7.3 Students' Classroom Performance

Being equipped with smart phones, students performed actively in sharing and discussing the learning artifacts, collecting data in the experiments, and interacting with teachers. In M5ESC, to promote students' engagement in the collaborative activities in the classroom, students were encouraged to share their learning artifacts with their partners or the class. At the later stage of M5ESC implementation, most students became more comfortable when their teacher presented their work via projector on the white board. They interacted more frequently with the teacher to share their reasoning and thinking. This was very different from the situation in 2012 when students had considerable concerns about receiving negative comments from the teacher and their classmates. Using exploratory questioning in the M5ESC classroom, the teacher provided more space for the students to think, reflect and explain by themselves instead of providing comments directly to the students (Kerawalla, Marilena, & Scanlon, 2013). Hence, influenced by the open questioning learning environments, students' participation in classroom sharing and discussion was promoted, which in turn contributed to the positive changes in their learning performance. At the later stage, students had better understanding of the value of the smartphone for searching online information and collecting data during experiments. When collaborating with their partners in experimentation, they gradually developed the habit of using smart phones to document the experiment by making videos or taking pictures. As we observed, when one student was doing the experiment, her/his partner would use the phone to record the phenomenon. This pattern of collaboration was common in the M5ESC classroom, as well as in the field trips and other out-of-classroom group activities.

8. Conclusion

This study presents findings from a sustained seamless learning project in a primary school. The research design was guided by two research questions concerning the design of the pedagogical principles for mobile learning and its educational value for improving students' science learning. In complementing current studies on mobile learning, the paper first provides the theoretical foundations on how the seamless learning program was established and how it was integrated into a standard-based science curriculum. The mobile learning design for knowledge construction is proposed to improve the pedagogical design of mobile learning. The design of activities at different cognitive levels narrows the gap between the purpose of research design and the needs of school-based curriculum design.

Researchers have pointed out that the dearth of research in any large-scale and sustained deployment of mobile learning, and the extent to which the unique attributes of mobile learning may be lost or compromised (Traxler, 2007). There is little research that has managed to trace the yearly progression of students' performance in mobile learning with the combination of quantitative and qualitative data at scale. Our study attempts to bridge this gap. The cross-year comparison of students' academic achievements, mobile learning artifacts and their activity performance provide valuable information on how to evaluate the outcomes and processes of mobile learning and how to encourage the practitioners to buy-in, sustain, and scale the curriculum innovation. The findings indicate that students could benefit from the mobile learning when it was pedagogically integrated with the standardized science curriculum.

This research can inform the pedagogical design of mobile learning, as well as research design of studies on ICT-supported curriculum. Early research has highlighted that the intensive use of technology does not mean the achievement of meaningful learning, and now the research focus has been

shifted to the pedagogical design of technology-supported learning. Thus, in ICT-supported learning design, the developers and practitioners should focus on the integration of ICT into routine lessons and on linking the purpose of activity design with the learning objectives as prescribed in the syllabus. The evaluation of students' performance should not depend heavily on students' self-reports. Researchers are encouraged to explore students' performance both in and out of classroom and to study the evidence arising from their practices. Such efforts will contribute to the research in technology-supported learning, especially involving the use of ubiquitous mobile technologies.

Acknowledgements

The paper is a part of work from project "Bridging Formal and Informal Learning Spaces for Self-directed & Collaborative Inquiry Learning in Science" funded by Singapore National Research Foundation (NRF2011 - EDU002-EL005). We would like to thank our other team members Gean Chia and Peter Seow, and teachers and their students from Nan Chiau Primary School for working and collaborating on this project.

References

- Ahmed, S. and Parsons, D. (2013). Abductive science inquiry using mobile devices in the classroom. *Computers & Education*, 63, 62-72.
- Brooks, J. G., & Brooks, M. G. (1993). *In Search of Understanding: the Case for Constructivist Classrooms*. Alexandria, VA: Association for Supervision and Curriculum Development.
- Bybee, R. W. (2006). The BSCS 5E Instructional Model: Origins and Effectiveness. A Report Prepared for the Office of Science Education, National Institutes of Health.
- Fosnot, C. T. (1996). Constructivism: A psychological theory of learning. In C. T. Fosnot (Ed.), *Constructivism: Theory, perspectives, and practice* (pp. 8-33). New York: Teachers College Press.
- Franklin, T. (2011). Mobile learning: At the tipping point. *The Turkish Online Journal of Educational Technology*, 11(4), 261-275.
- Greca, I. M. & Moreira, M.A. (2000). Mental models, conceptual models, and modeling. *International Journal of Science Education*, 22(1), 1-11.
- Huang, Y.-M., Lin, Y.-T., & Cheng, S.-C. (2010). Effectiveness of a mobile plant learning system in a science curriculum in Taiwanese elementary education. *Computers & Education*, 54(1), 47-58.
- Jeng, Y.-L., Wu, T.-T., Huang, Y.-M., Tan, Q., & Stephen, Y. (2010). The Add-on impact of mobile applications in learning strategies: A review Study. *Educational Technology & Society*, 13(3), 3-11.
- Jones, A. C., Scanlon, E., & Clough, G. (2013). Mobile learning: Two case studies of supporting inquiry learning in informal and semiformal settings. *Computers & Education*, 61, 21-32.
- Kerawalla, L., M. Petrou, et al. (2013). Talk Factory: supporting 'exploratory talk' around an interactive whiteboard in primary school science plenaries. *Technology, Pedagogy and Education*, 22(1), 89-102.
- Kinchin, I. M., & Hay, D. B. (2000). How a qualitative approach to concept map analysis can be used to aid learning by illustrating patterns of conceptual development. *Educational Research*, 42(1), 43-57.
- Lee, W.O. (2013). The conceptual framework of the 21 st century competences. Keynote paper presented at the Education and 21st Century Competencies, hosted by the Ministry of Education, 22-24, September, Oman.
- Linn, M. C., & Eylon, B.-S. (2011). *Science Learning and Instruction: Taking Advantage of Technology to Promote Knowledge Integration*. New York: Routledge.
- Looi, C.-K., Seow, P., Zhang, B.H., So, H.-J., Chen, W., Wong, L.-H. (2010). Leveraging mobile technology for sustainable seamless learning: a research agenda. *British Journal of Educational Technology*, 41(2), 154-169.
- Looi, C.-K., Wong, L.-H., So, H.-J., Seow, P., Toh, Y., Chen, W., Zhang, B.H., Norris, C., & Soloway, E. (2009). Anatomy of a mobilized lesson: Learning my way. *Computers & Education*, 53(4), 1120-1132.
- Looi, C.-K., Sun, D., Seow, P., Chia, G. (2014). Enacting a Technology-based Science Curriculum across a Grade Level: The Journey of Teachers' Appropriation. *Computers & Education*, 71, 222-236.
- Ministry of Education. (2008). Science Syllabus Primary 2008. Retrieved from: <http://www.moe.gov.sg/education/syllabuses/sciences/files/science-primary-2008.pdf>
- Motiwalla, L. F. (2007). Mobile learning: A framework and evaluation. *Computers & Education*, 49(3), 581-596.
- Naismith, L., Lonsdale, P., Giasemi, V., & Sharples, M. (2004). Literature Review in Mobile Technologies and Learning. Retrieved from: http://archive.futurelab.org.uk/resources/documents/lit_reviews/Mobile_Review.pdf.

- Ng, W., & Nicholas, H. (2013). A framework for sustainable mobile learning in schools. *British Journal of Educational Technology*, 44(5), 695–715.
- Ruchter, M., Bernhard, K., Werner, G. (2010). Comparing the effects of mobile computers and traditional approaches in environmental education. *Computers & Education*, 54 (4), 1054-1067.
- Sha, L., Looi, C.-K., Chen, W., Seow, P., & Wong, L.-H. (2012). Recognizing and measuring self-regulated learning in a mobile learning environment. *Computers in Human Behavior*, 28 (2), 718-728.
- Sharples, M., I., Inmaculada, A. S., Marcelo, M., & Giasemi, V. (2009). Mobile learning: Small devices, big issues. In: Balacheff, N., Ludvigsen, S., Jong, T. de., & Barnes, S. eds. *Technology Enhanced Learning: Principles and Products*. Heidelberg, Germany: Springer, pp. 233–249.
- Slotte, V., & Lonka, K. (1999). Spontaneous concept maps aiding the understanding of scientific concepts. *Journal of Science Education*, 21(5), 515-531.
- Song, Y. (2014). “Bring Your Own Device (BYOD)” for seamless science inquiry in a primary school. *Computers & Education*, 74, 50-60.
- Song, Y., Wong, L.-H., Looi, C.-K. (2012). Fostering personalized learning in science inquiry supported by mobile technologies. *Education Technology Research Development*, 60(4), 679-701.
- Starkey, L. (2011). Evaluating learning in the 21st century: a digital age learning matrix. *Technology, Pedagogy and Education*, 20(1), 19-39.
- Traxler, J. (2007). Defining, discussing, and evaluating mobile learning: The moving finger writes and having writ... *International Review of Research in Open and Distance Learning*, 8(2).
- Wong, L.-H. & Looi, C.-K. (2011). What seems do we remove in mobile-assisted seamless learning? A critical review of the literature. *Computers & Education*, 57(4), 2364-2381.

Maparin: Creating a Friendly and Adaptable Learning Scenario for Foreign Students in Taiwan

Wei-Tung TANG^{a*} & Shelley Shwu-Ching YOUNG^b

^aInstitute of Information Systems and Applications , National Tsing Hua University, Taiwan

^bInstitute of Learning Sciences, National Tsing Hua University, Taiwan

*scy@mx.nthu.edu.tw

Abstract: In this paper, we describe a mobile App called Maparin. It has been designed to facilitate foreign students enrolled in National Tsing Hua University (NTHU, Taiwan) while adapting to this Chinese speaking environment. Focused on providing complementary learning material in addition to regular Mandarin course training, the App leads foreign students to their desired restaurant to undertake Chinese learning and social interaction with locals in a real-life context. With the built-in GPS and Augmented Reality (AR) display, students equipped with iPad App have the ability to decide when and where to acquire essential Chinese language knowledge in informal settings. In addition, an embedded Automatic Speech Recognition (ASR) assessment system allows foreign students to learn the authentic pronunciation of daily meals in Taiwan. Moreover, a group of foreign students have been selected for system testing and evaluation. The experimental result shows that food ordering and campus restaurant locating via Maparin is much more efficient and satisfying for the foreign students.

Keywords: Social networking sites, augmented reality, mobile assisted language learning, ubiquitous learning

1. Introduction

For years, Taiwanese institutions have been marketing their curriculum to future international students. According to statistical reports on registered international students from Ministry of Education in Taiwan, the total student population increased from 55,463 to 78,261 (from 2011 to 2014).

Yet, it has been reported that most of the international students have experienced culture shock or had problem to adapt to a Chinese speaking environment in Taiwan or China (Paniagua 2009; Morataya 2012; Hu, Al-mekhlaf, Sun & Zheng, 2010). Most of the international students in Taiwan acquire

Chinese as a second or foreign language in a class setting. Therefore, the only language practice is done during class, which means students are not frequently exposed to the language and the people who use it on daily basis. Chinese is a difficult language to acquire due to its complex characters' shapes, multiple meaning and intonations (Tseng, Lu & Hsu, 2006). Thus, if students do not have enough language practices with peers or local students, the acquired knowledge from language training courses would likely to be forgotten.

Field trip is a popular alternative solution in addition to regular class (DeWitt & Storksdieck, 2008). This type of extracurricular activity helps students to discover things they have never experienced before such as night market and local cuisine. In this study, we discuss an implemented mobile App focusing on assisting overseas students especially for food purchase on or off campus, and how students can use it to their advantage. At the early stage of this research, we investigated what type of survival difficulties international students might have faced since arrival in Taiwan. Questionnaires were responded by 51 international students from 3 Mandarin classes of basic levels. 4 major complaints from students were identified and are listed as follows:

- Having little or no idea about where to get safe and healthy food for students with different religious beliefs.
- Having little or no desire to speak Mandarin in public due to poor Mandarin pronunciation performance.
- Most of local restaurants do not offer English menu.
- Having little or no idea about how to respond to restaurant owners on customizing their orders.

To address these problems, we implemented an iPad App named Maparin. It is integrated with Facebook social feature and Augmented Reality (AR) display, focusing on helping students to learn how to order food and customize their orders in an informal learning situation. With a couple of finger clicks, students are able to browse through the restaurant information within campus area.

2. Related Work

2.1 Acculturation

The process of one being transformed in a cultural or psychological way is called "Acculturation" (Sam 2010). *Integration, assimilation, separation* and *marginalization* are four possible strategies when individuals decide to maintain a balance between their heritage culture and alien culture (Berry, 1974). It is important to understand how international students in Taiwan would behave while dealing with this psychological (e.g., self-esteem) or socio-cultural (e.g., acquiring a new language) transition. The latter is vital to study because the way how students adapt to the new environment and language can and will be different. The transition experience varies individually. Difficulties stemming from language or culture differences may frustrate students, resulting in lack of interest in cultural maintenance or having no desire to develop relationship with others. Students who integrated with target culture usually tend to participate in the community, ultimately developing a sense of belonging.

On the other hand, those who find no interest in target culture and language will choose to maintain a distance from the community.

International students in Taiwan usually are not required to take Mandarin courses during their academic years. Yet, it is vital for those who are interested in Chinese or Taiwanese heritage and culture to achieve basic level of Mandarin. In order to be able to participate as a member of Taiwanese community, students will need to be trained before they can start communicating with the outside world. In this study, we work to provide better adaptation experience via mobile technology. To ensure a better learning experience and lower frustration that may ultimately lead to marginalization from the target language or culture is our top priority.

2.2 Chinese as a Foreign Language (CFL)

Learning Chinese as a foreign language is a great challenge because it has a total different syntactic structure, the lack of common roots in the vocabulary, five distinct lexical tones, 22 consonants initials and 38 vocalic finals (Tseng et al, 2007). For Chinese reading and speaking, Pinyin is widely practiced in most of the language institutions in Taiwan. Pinyin is an official phonetic system transcribing Chinese characters' pronunciation into Latin alphabet (Margaret& Charles, 2005), making CFL students easier to relate while attempting to acquire and pronounce a new vocabulary. However, using Pinyin alone may cause confusion by making false tone utterance. As we have mentioned above, there are five tones in Chinese language. Different tone utterance may yield different word of meaning, making native listener of Chinese confused while students attempt to express themselves in Chinese. Related study confirmed that single tone can be learned by CFL learners quickly. However, attempting to articulate a sequence of tones from any given reading text can be much more difficult (Mixdoff, Külls, Hussein, Shu, Guoping & Si, 2009).

For learners whose native language is non-tonal, tone utterance and identification pose a great difficulty to them (Wang, Jongman & Sereno, 2003). In Wang's previous study (Wang et al, 1999), it shows that training Americans to perceive Mandarin tones is proved to be effective. Participants received intensive Mandarin tone perception practice and identification. Result shows a 21% improvement in tone identification post-test, and such gains were retained even after 6 months. In their extended study (Wang et al, 2003) further states that improved perception in Mandarin tones also contributes to better tone production performance.

In this study, both pinyin and pronunciation demo audio are both included in order to provide a more precise tone perception practice for international students. Moreover, knowing how to pronounce in a correct tone will also help lowering students' speech anxiety.

2.3 Situated Learning

The basic idea of situated learning is that the learning process is a mutual interaction between the learners and their environment. Therefore, instead of being observers, learners take a step forward and

actively involves in the interactions with the community (Lave & Wenger, 1991). Smartphones and tablet PCs are equipped with advanced GPS and digital compass will certainly play a major role in situated learning. Learning that takes place outside of the classrooms can be greatly benefited by mobile devices in the following ways: wireless network empowers its users to fetch desired location information seamlessly, making learning content accessible anytime, anywhere. Well-designed Apps with appropriate learning content can be downloaded before the outdoor activities start, further enhancing learning experience.

Related projects also indicate that learning that takes place in the context of real life is a more applicable way of problem solving. A similar study called MicroMandarin adopts a location-based social networking service “Foursquare” to determine learners’ location and push corresponding Mandarin vocabulary flashcard for its users to undergo learning (Edge, Searle, Chiu,Zhao & Landay, 2011). In Beijing Normal University, an interesting AR based android App was implemented to facilitate campus culture events. Users were able to search for online information by simply clicking on icons on screen that represented desired location information on android based phone (Pei & Cai, 2013).

We have also reviewed several other interesting learning systems using various wireless technologies. It has come to our attention that there is only a small portion of studies that focus on CFL learners of Chinese in Taiwan, particularly targeting at foreign students. The Cross Platform Map System (CPMS) is a mobile application that offers a virtual map with English and Chinese information available (Paniagua, 2009). The mobile system was implemented to assist foreign students to learn and acquire Chinese characters. The results showed a notable improvement in students' ability to recognize characters that were presented in a campus environment. However, the experiments in the CPMS project were conducted under a pure laboratory environment. Foreign students simulated a self-guided tour by using the virtual map, resulting in a lack of interaction between students and native speakers of Taiwanese citizens. Another study that focused on creating an interactive learning environment for foreign students in a real-life context was presented to address the lacking of interaction between students and people who use Chinese as a spoken language in CPMS project (Morataya, 2012). In Morataya's study (2012), a mobile game-based learning system was presented, using riddles and score system to support CFL learning. Foreign students who participated in Morataya's study reported that they had great fun learning Chinese while doing quests around the designated campus building and places. Students also reported it was a great idea to engage Taiwanese citizen in real-life conversation in Chinese especially when they had a basic idea about the subject of the conversation would be.

Each of the similar learning projects has their own strength and weakness. MicroMandarin is an innovative one because of its unique location-aware mechanism. Being a vocabulary flashcard based learning application, it lacks of the interaction between users and the application by only providing static pictures for each scenario. CPMS is an excellent location information indicator which supports bilingual learning scenario. Unfortunately, the study did not engage its subjects in the physical learning environment. In Morataya's study, we have seen that a great game-based learning

design can help its learners to immerse in any possible environment and actually acquire knowledge. However, the majority of Morataya's participants reported that 3G wireless network coverage was unstable and campus WIFI transferring between each building also made it less user-friendly while doing quests from one location to another. In addition to network issue, one concern was made aware by the majority of participants who complained about getting lost while doing quests because the mobile system did not provide a real-time location update as they travelled between buildings. Finally, there was no text-to-speech (TTS) function or audio file available for students to imitate from. Thus, students could only depend on Pinyin to learn how to pronounce recently acquired Chinese characters, resulting in mispronunciations and confusions while initiating conversations with the locals.

To address the problems mentioned in this section, the proposed system takes advantage of mobile devices and an advanced 4G network to allow students to access crucial learning content in real-time. An embedded Automatic Speech Recognition (ASR) module is included in the proposed system, allowing students to check their speaking performance before making contact with the locals. Chinese vocabulary and conversations that are made available in audio form (MP3 file) were pre-recorded by a native speaker, allowing students to imitate authentic pronunciation.

All in all, the proposed system made several attempts to enhance learning experience and promote students to fully engage in the learning content of this study. The learning scenario set for this study is about a group of international students who are tired of ordering the same food they can recognize. By using the location finding technologies such as Facebook check-in, AR display and Google Map, they are able to go on a self-guided food hunting in Taiwan. Most important of all, the proposed system empowers them to initiate basic daily conversations with Taiwanese locals.

3. System Implementation

3.1 System Architecture

This system is built based on client-server architecture. On client side, an App is implemented on iPad. The App is connected to remote data server. Most of the information related to local restaurant, food item information and pronunciation demo audio file are stored on the remote sever. It means wireless network is required to launch the App for data request and transmission between two components. The system architecture is shown in [Figure 1](#).

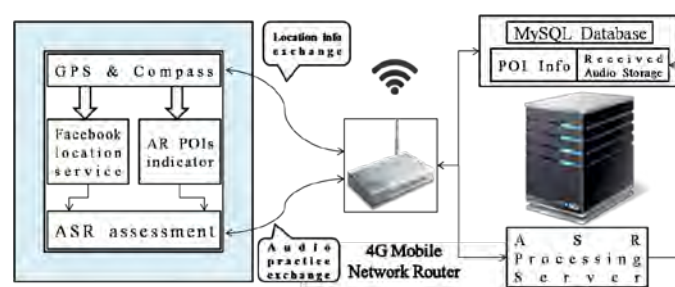

Figure 1. System Architecture.

3.2 Mobile App

The design of this mobile application consists of 3 major features:

- Integration with Facebook social feature, making social connection possible.
- An Augmented Reality (AR) based location indicator.
- An ASR assessment system, allowing international students to practice how to make food order in Chinese.

The App requires its users to login via Facebook accounts. As shown in Figure 2a, an AR display serves as one of the location finding options for learners who feel like to scan what type of restaurants are around them. The second option contains a map, which reveals user's current location. The flickering blue dot indicates user's exact geography location (shown in Figure 2b). Three pre-defined search filters has been deployed to assist students to perform check-in from Facebook database. When selecting any of the filters, the system will perform a nearby location check to determine learners' nearby restaurant information. Students then will be able to select the local restaurants in the neighborhood to start acquiring Taiwanese food items and practice how to pronounce them via ASR assessment.

The mobile App is implemented with various web development techniques and Apple iOS development SDK 6.0. On the client side, mobile App is developed using Xcode. Facebook SDK 3.0 and ARtoolkit are integrated during implementation. On the server side, (JSON) and SQL database are deployed to serve as data center. JSON is used to bridge the communication between iPad and the SQL database. Additional Hypertext Preprocessor (PHP) pages are also scripted for data exchanging between mobile App and Apache server. The speech recognition also plays a crucial part in this project. The ASR toolbox is designed by Professor Jyh-Shiung Roger Jang (National Taiwan University, Taiwan). Upon receiving learners' recorded audio file, it will be sent back to the remote server for further performance evaluation. The pronunciation performance is rated on a scale of 100.

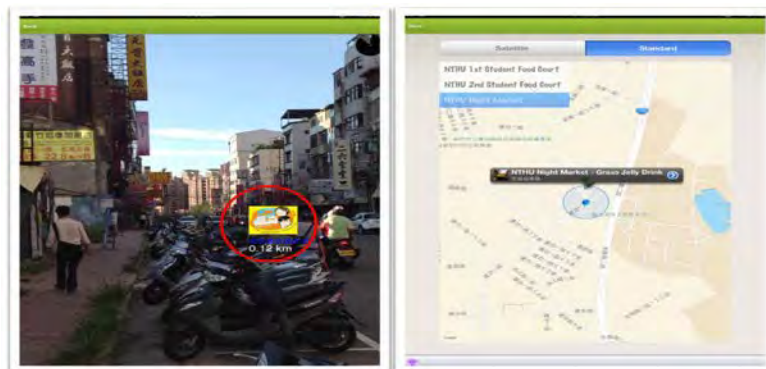

Figure 2. App Snapshots –

(a)AR display Mode (b) Facebook Check-in Mode

4. Evaluation

4.1 Test Design

4.1.1 Participants

29 international students from a variety of departments of NTHU participated and completed the evaluation (graduate level, business and engineering background). The students were of age 22 to 30. 11 of the participants are female and 18 are male. Their average time spent in Taiwan is 12 months, ranging from 6 months to 18 months.

4.1.2 Procedure

The entire evaluation session lasted 2.5 hours. The session included a pretest, a usability test, a post-test and an individual interview.

In the pretest, we measured the participants' Chinese speaking ability by using the mobile App's embedded ASR assessment tool. Questions were generated with a combination of Taiwanese food item names and sentences of standard way of food ordering in Chinese. The test was validated by an official Mandarin teacher from Chinese language center of NTHU. In addition, the pretest was taken by 5 of Taiwanese native speakers previously. The average score obtained from native speakers was 85 (on a scale of 100). The participants were given instructions on how to use the mobile App. They were given an hour to play with the App and browse through the nearby restaurants and the food items. During this hour, they were also required to make practices with ASR assessment every time they viewed a different restaurant.

Once the required App trial and practices were completed, a field trip was deployed to observe if the participants were able to reach restaurants in a nearby night market by using the App. There are approximately 20-25 restaurants including small sized food stands, which only offer take-out service. The subjects were not made aware of the exact location on the ones they were going to visit. At this time, the subjects were equipped with one iPad each person. Upon reaching the selected restaurants, the subjects were required to salute the owners and make the orders in Chinese. Each of them was required to visit 3 different restaurants (10 restaurants were available in the mobile App).

4.2 Results and Feedbacks

The learning achievement result is processed by comparing the score generated from pretest and post-test (shown in [Table 1](#)). During the pre-test, the score distribution is not consistent (lowest score = 31.5, highest score = 74.5). The majority of the subjects obtained score between 50 to 65, indicating that the students' attempts to pronounce Chinese food item names and short sentence using Pinyin alone was not effective and they did make several false tone utterances. In the post-test, however, there is a significant improvement in pronunciation (lowest score = 66, highest score = 87).

Table 1: Pronunciation achievement test result

Test type	N	Lowest score	Highest score	Mean(full scores)	SD
Pretest	29	31.5	74.5	59.96 (100)	10.36
Post-test	29	66	87	73.75 (100)	05.54

The result confirmed and supported the idea of consistent Mandarin tone perceptual practice will make CFL learners to achieve better performance in tone production since ASR assessment system generated personal score based on subjects' tone accuracy and intonation. The input made by the subjects needed to be matched with the corresponding food item name in Chinese before being sent to remote server for assessment. False and inappropriate input will be detected and denied.

For the field trip, all of the subjects were able to locate their desired restaurants or food stands out of night market within 15 to 20 minutes. Please note that restaurant locating and food ordering was undertaken by the subjects themselves. No hints were given during the entire field trip. The subjects reported that AR location indicator helped much when they could not locate the destination using embedded Google map and Facebook check-in. If they were not sure to go right or left, they would switch to AR display to decide which way to take. As for the restaurants visit and food order, subjects reported that it was a wonderful experience to literally initiate conversation with Taiwanese in Chinese. All of the subjects were able to complete the order after using the App. 83% (24) of the participants found it extremely interesting and useful when they succeeded in making orders in Chinese. They expressed that this type of experience is unforgettable and influential for their future encounters in Taiwan.

5. Conclusion and Future Work

In this study, a novel campus restaurant information system for Chinese pronunciation practice and restaurant finder has been designed and implemented. The proposed system engaged its participants in a real-life context, enabling them to participate the society as a normal Taiwanese citizen would do on daily basis. With the advanced mobile technology and wireless network, the proposed system effectively supported its users to reach their desired restaurants and facilitated their social interaction with locals, providing a smooth and friendly user experience.

Yet, to continuously improve the mobile App, there are several factors which have to be taken into consideration in its subsequent study. First of all, social collaboration capability has to be expanded. Participants reported that the ability to allow its users to upload their preferred point of interests should be made available if one wishes to share any recent spotted restaurant. Secondly, offline mode should be made available if one wishes to practice with ASR system. Currently, ASR assessment and pronunciation audio file can only be accessed via internet. Finally, more dialogues should be made available because restaurants owners sometimes ask more questions about their orders and the App does not have the solution to respond yet.

References

- Al-Mekhlafi, K, Hu, X. &Zheng, Z. (2009). An Approach to Context-Aware Mobile Chinese Language Learning for Foreign Students. *Mobile Business*, 340–346
- Berry, J.W. (1974). Psychological aspects of cultural pluralism. *Culture Learning*, 2, 17-22.
- DeWitt, J., &Storksdieck, M. (2008). A Short Review of School Field Trips: Key Findings from the Past and Implications for the Future. *Visitor Studies*, 11(2), 181–197.
- Edge, D., Searle, E., Chiu, K., Zhao, J., Landay, J.A.(2011):MicroMandarin: Mobile Language Learning in Context. In: Proc. of CHI 2011, pp. 3169–3178. ACM.
- Lave, J., & Wenger, E. (1991). *Situated learning: Legitimate peripheral participation*. Cambridge university press.
- Margaret, S.J.,&Charles, H. (2005). *The science of reading: a handbook*. Blackwell handbooks of developmental psychology) 17. Wiley-Blackwell. pp. 320–22. ISBN 1-4051-1488-6.
- Mixdorff, H.,Külls, D., Hussein, H.,Shu, G., Guoping, H., Si, W. (2010).:Towards a Computer-aided Pronunciation Training System for German Learners of Mandarin - Prosodic Analysis. In: L2WS-2010, Tokyo
- Morataya, S. (2012).A study of the mobile game-based system to support the Chinese speaking language and motivation of international students. Master Thesis. National Tsing Hua University, Hsinchu, Taiwan.
- Paniagua, Y. (2009). A cross platform map system (CPMS) to facilitate adaptation and language learning for international students in a Chinese-speaking environment. Master Thesis. National Tsing Hua University, Hsinchu, Taiwan.
- Pei, L,S., Cai, S. (2013). Mobile Campus Touring System based on AR and GPS: a Case Study of Campus Cultural Activity. *Proceedings of the 21st International Conference on Computers in Education*. Indonesia: Asia-Pacific Society for Computers in Education.
- Sam D. L. and Berry J. W. (2010) Acculturation – When Individuals and Groups of Different Cultural Backgrounds Meet. *Perspectives on Psychological Science July 2010 vol. 5 no. 4* pp.472-481
- Tseng, C.-C., Lu, C.-H., & Hsu, W.-L. (2007). A mobile environment for Chinese language learning .In M. Smith & G. Salvendy (Eds.), *Human Interface and the Management of Information. Interacting in Information Environments* (Vol. 4558, pp. 485-489): Springer Berlin / Heidelberg.
- Wang, Y., Spence, M. M., Jongman, A., and Sereno, J. A. (1999). “Training American listeners to perceive Mandarin tones,” *J. Acoust. Soc. Am.* 106,3649–3658.
- Wang, Y., Jongman, A., &Sereno, J. (2003). Acoustic and perceptual evaluation of Mandarin tone productions before and after perceptual training. *Journal of the Acoustical Society of America*, 113 (2003), pp. 1033–1043

Schema Formulation with Schema Priming Test in Elementary Arithmetic Class in Japan

Kazuhisa SETA^{a*}, Akira SHIMAZOE^{a*}, Kanetaka MORI^{b*}, and Masahiko OKAMOTO^{b*}

^a*Graduate School of Science, Osaka Prefecture University, Japan*

^a*Graduate School of Humanities and Social Sciences, Osaka Prefecture University, Japan*

*seta@mi.s.osakafu-u.ac.jp

Abstract: In this research, we implemented a system for measuring schema formulation on mobile terminals, making it easy to use in ordinary classrooms. We operated this system in an elementary school over an extended period of one month. The results showed that operating the system (1) was useful for schema formulation in students, particularly if they were weak in arithmetic, and (2) helped teachers understand students' level of comprehension, suggesting that it could help in teaching according to level of comprehension. This article gives an overview of the system developed and reports on the results of operation in the elementary school.

Keywords: Schema, Long-term Use, Mobile Terminal, Elementary Arithmetic, Operational Model

1. Educational Systems Supporting Educational Practice

1.1 *Practical use of Educational Support System in the Classroom*

Recently, as research advances, various educational support systems have been developed and embedded into real classroom environments, from the elementary to higher education. For example, "Monsa-kun" is an environment supporting problem posing in arithmetic, which has been reported to improve basic capabilities of problem-solving for children having difficulty with word problems in mathematics (Hirashima, Yokoyama, Okamoto and Takeuchi 2006, Yamamoto, Kanbe, Yoshida, Maeda and Hirashima, 2013). In secondary education, learning support systems such as EBS (Horiguchi, Imai, Tomoto and Hirashima, 2007) have been proposed using advanced information technologies, and in higher education, cases of research have reported on self-directed learning in a hyper space (Kashihara and Akiyama 2013, Ota and Kashihara 2010, Jouault and Seta 2014), and on training logical thinking and meta-cognitive skills in presentations (Okamoto, Watanabe and Kashihara 2013, Shibata, Kashihara and Hasegawa 2013, Kojiri and Iwashita 2013, Seta, Cui, Ikeda, Matsuda and Okamoto 2013, Seta, Noguchi and Ikeda 2011).

Looking at these learning-support systems from an information technology perspective, when they are aimed at relatively advanced post-secondary students, they tend assume computer literacy in users so they can be more advanced and incorporate more sophisticated functionality into a system.

From this perspective, current research on learning support systems can be categorized according to emphasis on (1) establishing the advance in learning support function from an information technology perspective, together with the proposed new learning method that accompanies it, or (2) eliminating learning difficulties actually encountered by children, as with Monsa-kun.

For the learning support systems in category (1) it tends to be difficult to set a common curriculum in the universities and colleges where they are used, and the computer systems developed tend to assume use in a limited range of scenarios. They have not proposed 'operational models' that anticipate expansion into many educational scenarios, because they require, for example a specialized computing environment. Conversely, learning support systems that focus on solving issues in real learning environments, such as Monsa-kun and the system from Deguchi (Deguchi, Yamaguchi, Funaoi and Inagaki, 2004), need to be able to be embedded into teaching scenarios with strong time constraints,

as is the case in schools. This restricts the functionality that can be incorporated, but handles difficulties faced by many students, so such systems have proved to be useful.

Of course, much of the research attempts to address both aspects, (1) and (2), so it is difficult to divide all research into two clear categories, but it is unmistakable that research on learning support systems that aim to be used in a wide range of learning environments must clarify what it means for a system to be useful when introduced into real learning scenarios.

The primary goals of this research, as a research approach oriented to practical use in the classroom, are to develop Schema Priming Tests (SPT), which are an instructional support and assessment tool for resolving issues with elementary school students having difficulty solving arithmetic word problems, and to operate it for approximately one month to identify issues in embedding it into classrooms.

1.2 Using Educational Support Systems Integrated with Teaching

For the past 20 years or so, the phrase “formative assessment is the most important assessment for instruction” has been used often in Japanese schools. It refers to teaching while maintaining a continuous awareness of the students’ understanding of the material. To do so, formative assessment must be taken several times within a teaching unit to understand the extent to which each student has acquired the relevant skills and where they are encountering difficulty. Knowing the learning results from each student in this way is also helpful for teachers to improve their instructions.

However, even when using integrated instruction and assessment, the main role of teachers is to teach, so they cannot spend large amounts of time carefully assessing the learning activities of individual students. With the recent spread of tablet terminals, students can have their own terminal, and the potential for providing learning support to individual students according to their progress is expanding. Considering this, one of the advantages of a learning support system using tablet terminals is as a formative assessment tool for understanding children’s learning progress.

In other words, an effective way to use tablet terminals would be as a tool to assess children’s understanding of the content of a unit as the unit is being taught in school.

A secondary objective of this research was to use the iPod Touch as a tablet terminal, together with Schema Priming Tests (SPT) implemented on it, integrated into teaching of a unit on area to grade five students. This was used to conduct practical research on the effectiveness of using SPT for longitudinal assessment and support of the process of schema formulation.

In Section 2 below, we discuss the reasons and process of developing SPT and in Section 3 we give an overview of the system. Section 4 gives an overview of the experimental study conducted using SPT, Section 5 discusses the effectiveness of SPT, and Section 6 summarizes the conclusions.

2. Solving Process of Word Problem and Schema

2.1 Process of Solving Arithmetic Word Problems

It is not rare for children to have difficulty with arithmetic word problems, and approximately 30% cannot solve them, regardless of whether they are able to solve calculation problems (Okamoto 1999).

The reason that word problems are found difficult is that they are composed of two processes, that of reading and understanding the word problem, and that of performing the calculation to reach to the answer. Generally, most children that cannot solve word problems are able to solve calculation problems, so of these two processes, it is less common for children to fail at performing the calculation to get the answer.

Recently, the four phases theory (Mayer 1985, Cummins, Kintsch, Reusser and Weimer, 1988) has become influential, stating that solving word problems occurs in four qualitatively different steps. These four steps are 1. Translation, 2. Integration, 3. Planning, and 4. Execution.

According to Okamoto, they consist of the following cognitive processes:

- **Translation:** Translating from a problem text into mental representation with mathematical and syntactical knowledge.

- **Integration:** Determine the problem type using schema knowledge, and integrate it with the overall problem representation.
- **Planning:** Establish a plan (equation) to achieve the goal, based on the overall problem representation.
- **Execution:** Perform the calculation using knowledge of computational algorithms to obtain the answer.

Causes for failure in solving word problems occur in the three phases before execution, and particularly in the integration phase.

The integration phase involves the process of finding relationships among the multiple sentences in the word problem and creating a situation model that is a core representation integrating the overall problem. Then, for the type of word problems with few steps done at the elementary school level, an equation can be derived directly from this situation model. In other words, mistakes made in forming an equation are seen as failures at the integration phase rather than the planning and execution phases.

2.2 Problem Schema and the Integration Phase

In the integration phase, a situation model representing an overall understanding of the problem is built, and the student's pre-existing knowledge related to the problem structure, called problem schema, plays a most important role in the integration step. For example, reading the sentence, "How fast is Akira walking?" an adult would know this is a problem related to speed, and to solve it requires other factors such as distance and time. What enables adults to do this is having solved various types of problems related to speed in the past, and having acquired a schema for speed problems, which includes the formula, $\text{distance} = \text{speed} \times \text{time}$.

In fact, Mayer (Mayer 1985) identified various problem types among word problems that are taught in the early stages of elementary school, such as compare problems and change problems, and showed that students acquire problem schema for each problem type. Okamoto also showed that even with adults, if they did not have a clear problem schema for compare problems, they often had difficulty solving them, and that whether the problem schema is easy to use contributes strongly to problem integration.

Thus, problem schemas are strongly related to the integration step of solving word problems, and children that have formed a problem schema can more easily solve the problem. This suggests that supporting problem schema formulation in children using iPods, and providing longitudinal assessment of the level of schema formulation would be a powerful teaching support tool for teachers.

2.3 Theoretical Background for Schema Priming Tests

Schema priming tests were originally used by Okamoto as test problems and were developed as a tool for assessing the degree of schema formulation.

The basic idea is an application of the concept of semantic priming from cognitive psychology. Semantic priming is the phenomenon that processing of a target stimulus can be accelerated by presenting a stimulus that has a deep semantic relationship with the target stimulus, called the prime stimulus, before the target stimulus is presented.

In a schema priming test, a question (describing what will be required) is first presented as a prime stimulus, then the whole problem text (the target stimulus) is presented, and then the student is asked to decide semantically, whether they can solve the problem or not.

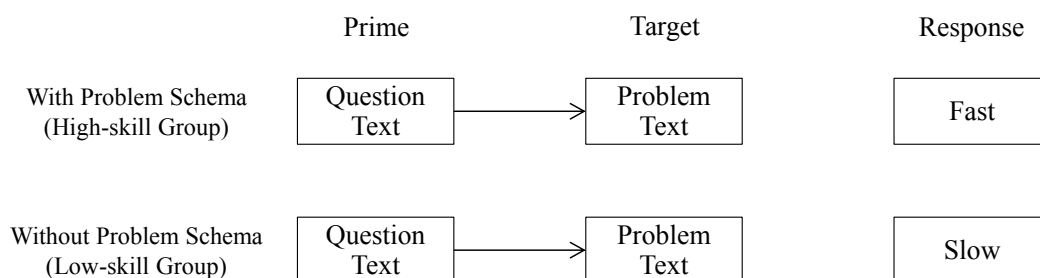

Figure 1. Relations between Schema Organization and Reaction Time

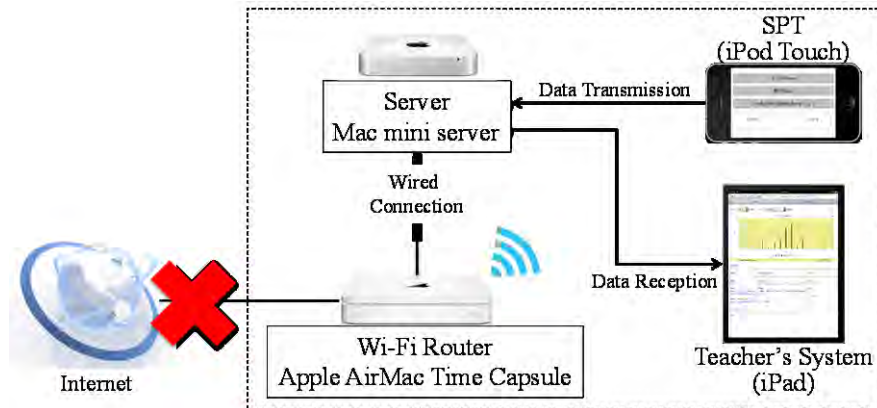

Figure 2. Structure of the System

If the student has an adequately formed schema, the response to the schema priming test will be faster, as shown in Fig. 1, so the degree of problem schema formulation can be determined by the shortening of test response times.

3. Development of Schema Priming Tests

3.1 Overall System Structure

The overall structure of the system developed in this research is shown in Fig. 2. The system adopts a client-server model built using a private network through a Wi-Fi router without Internet connection.

A Mac Mini Server is used to host a MySQL server, iPod Touch terminals are used to implement SPT on the client side, and an iPad is used to allow the teacher to see the work of the students. Building the system in this way has the following advantages:

1. There are no space constraints, such as needing to operate in a PC room, and it is easy to introduce into classes.
2. Children can operate it intuitively.
3. Due to the above, children more easily use it voluntarily outside of class.
4. The network system can easily be brought into a classroom as a package, so it is easy to use.
5. The state of students' activity is sent immediately to the teacher's system through the private network, promoting an integrated approach to teaching and assessment.

3.2 Basic Operation of the Schema Priming Test

The purpose of developing SPT was to measure students' level of understanding easily and accurately.

With SPT, a question (describing what will be requested) is first presented as the prime stimulus, then the whole word problem (the target stimulus) is presented, and then the student is asked to make the semantic decision, whether they can solve the problem or not.

According to Okamoto, students that have formed an adequate schema will be able to answer the above question quickly and correctly, and the student's degree of schema formulation can be

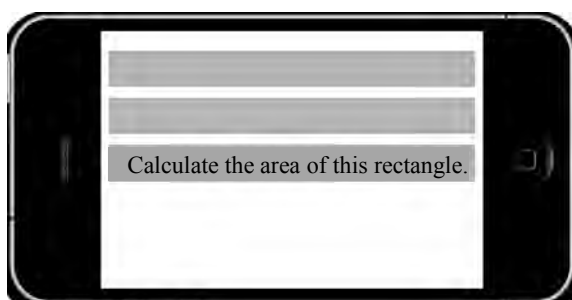

Figure 3. Prime

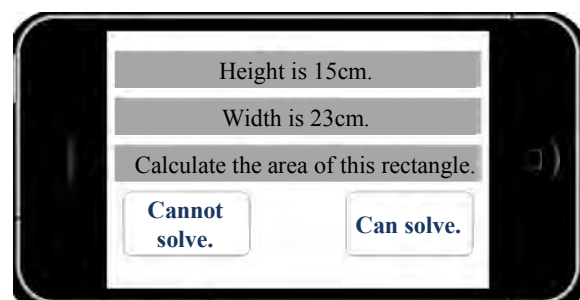

Figure 4. Target

determined from the response times and number of correct answers.

Schema knowledge is also used with conventional test problems, but what is assessed is the calculation written on the paper and the result, and the degree of schema formulation is not displayed. In contrast, the SPT developed in this research uses a question format that asks about the validity of a word problem (a format that does not necessarily require planning), so it is specialized to measure ability to understand the overall problem, in other words, schema formulation.

Specific operation of the system is described below. For each problem, the system presents (1) the question (e.g. “Calculate the area of this rectangle.” in Fig. 3), and (2) the conditions (e.g. “Height is 15cm,” “Width is 23cm.” in Fig. 4), with a delay, and then records the time from when the conditions were presented until the answer is given. Operation screens for the system developed in this research are shown in Fig. 3 and Fig. 4.

1. Question indicating what will be calculated is presented (Fig. 3: prime stimulus).
(Still for 3 s)
2. Overall problem presented (Fig. 4: target stimulus)

4. System Operation Overview

The sequence of experimental study is shown in Fig. 5.

- **Subjects:** 77 Grade 5 students from two classes in elementary school A (38 in one group, 39 in the other).
- **Time:** Oct. 31, 2013 to Nov. 29, 2013.
- **Teaching unit:** Finding areas of rectangles (sub-unit 1), triangles and parallelograms (sub-unit 2), and trapezoids and rhomboids (sub-unit 3).
- **SPT teaching materials:** Using the above sub-units, 16 word problems for each sub-unit were prepared as SPT materials.
- **SPT operation (during class):** As study of each sub-unit was completed in class, the system was used with the applicable word problems, also in class. Note that the second group of 39 students was not able to use the SPT after completing the topic on trapezoids and rhomboids. The instructors used the system additional times beyond what they did in class time, twice for the first group, and once for the second group. 42 numbered iPod Touch terminals were used. These were brought into the classroom by the teacher, and students used the same device, selecting the class and seat number on the screen before performing the SPT.
- **SPT operation (outside of class):** To give opportunities to use SPT outside of class time, the devices were placed in the class so students could use the system freely, without placing additional burden on the teachers. However, since the number of devices was limited, they were allocated by time periods to the different classes (e.g.: group 1 during the morning, group 2 in the afternoon). Mainly, they were used during two occasions given to group 1, and only a few members from group 2 used them outside of class.

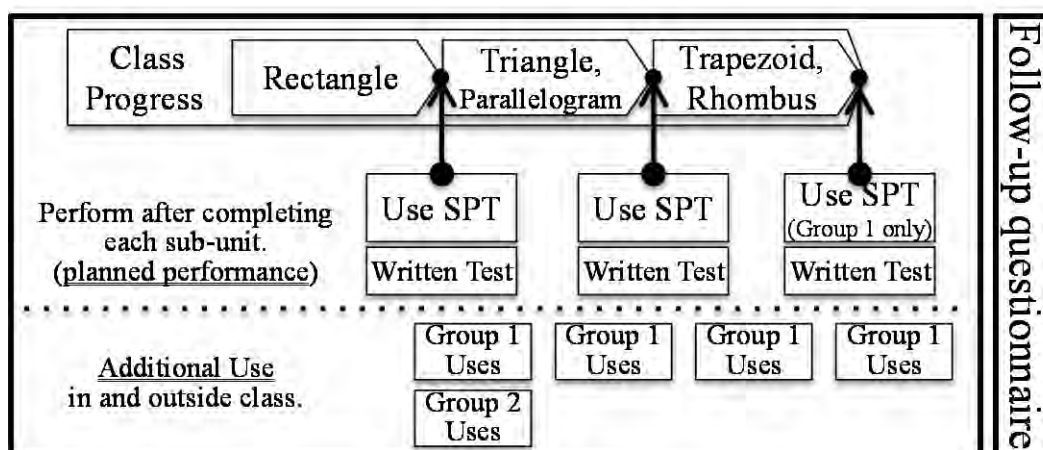

Figure 5. Flow of the Experimental Study

In addition to analyzing the level of effort, marks and response speeds for each student, the following confirmed the usefulness of operating the SPT for schema formulation.

- **Written tests:** After completing sub-units in class, the usual tests performed in school to test understanding and also written tests including extraneous problems (described below) were performed. Then, the relationships between those results and the level of effort and marks from the SPT were analyzed. These written tests consisted of four ordinary questions and four questions with extraneous information, totaling eight questions.
- **Teacher interviews:** Interviews were conducted with the two teachers after the experimental study, regarding the effects of the system on level of understanding, the students' involvement, and suggestions for improvement.
- **Student surveys:** A five-level survey of students was conducted after the practice, regarding system usability, ability to motivate, and effect on marks.

Extraneous problems are problems that include conditions that are not necessary to solve the problem. An example is shown in Fig. 6. Such problems require identifying the elements comprising the substance of the problem from among all of the information given and to determine what is enough information to solve it. As such, they are useful in determining the degree of schema formulation.

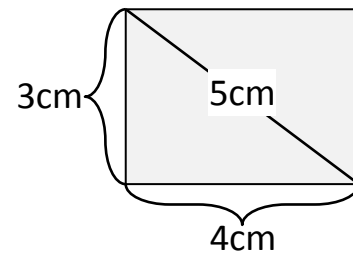

Figure 6. An Extraneous Problem

5. Schema Formulation and Problem Solving Performance Improvements through SPT

5.1 Schema Formulation Process through SPT

As described in Section 3, the students in group 2 were not given the opportunity to take the SPT for sub-unit 3, so we analyzed the data from the 38 students in group 1 regarding tendencies in response times.

The SPT response time trends for SPT done in the classroom after completing each of the three sub-units are shown in Fig. 7. A $2 \times 3 \times 2$ mixed ANOVA was done on the response times, using the three-factors of frequent vs. infrequent use, sub-unit (rectangles vs. triangles and parallelograms vs. trapezoids and rhomboids), and SPT problem type (normal vs. unsolvable). The first factor is between subjects, while the other two factors are within to subjects.

In the results of the distribution analysis, frequency as a primary effect was significant ($F_{(1,36)}=6.34, p<0.05$). The high-frequency group had shorter response times than the low-frequency group, and children that used the system more frequently clearly were able to determine more quickly whether they could solve the problems or not. The sub-unit also had a significant effect ($F_{(2,72)}=77.07, p<.01$). With low-order testing using the Bonferroni method, times for triangles and parallelograms are shortest, then for trapezoids and rhomboids, and finally for rectangles. Further, a main effect of problem type ($F_{(1,36)}=60.43, p<.01$) and an interaction of sub-unit \times problem type ($F_{(2,72)}=55.11, p<.01$) were significant, so in low-order testing, for rectangles, response times for solvable problems were clearly longer than for unsolvable problems.

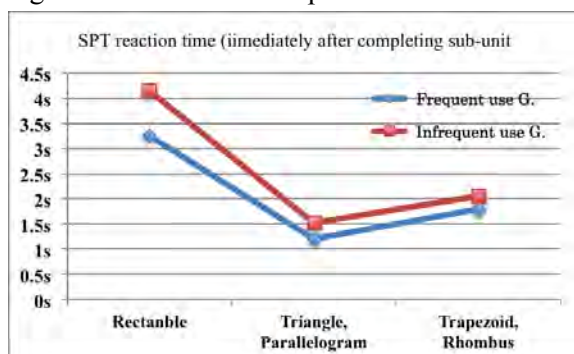

Figure 7. Mean Reaction Time of SPT in Area Unit

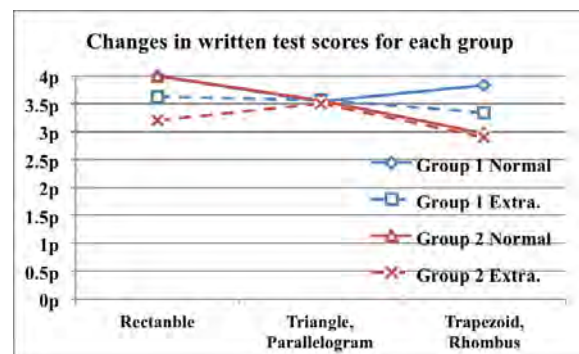

Figure 8. Mean Scores of Paper Test

Decision times were shorter for the high-frequency group, which could mean that subjects became more accustomed to using the system or that their schema formulation could have been more advanced. However, comparing the response times for sub-units, response times did not become shorter according to the number of tests, and the response times for sub-unit 2 were clearly the shortest overall to begin with. If response times became faster simply by repetitions and becoming familiar with operation of the system, then sub-unit 3 should have been the fastest, but sub-unit 2 produced the shortest decision times. This suggests that the decision time for schema priming tests is the time required to integrate the problem using schema knowledge. Considering this, the fact that the high-frequency group response times were shorter suggests that using the SPT more often promoted schema formulation.

5.2 Improvement of Problem Solving Performance through SPT

To study whether using the SPT promoted students' schema formulation requires comparison of a control group that does not use SPT, and an experimental group that does use SPT. As discussed earlier, group 2, which did not do SPT for sub-unit 3 on trapezoids and rhomboids, can be viewed as a control group. In other words, comparing group 1 with group 2 in sub-unit 3 can be considered a comparison of an experimental group with a control group. Accordingly, we did a comparative analysis of the written test results, including extraneous problems, from the two classes.

The written test scoring trends for each group are shown in Fig. 8. A $2 \times 3 \times 2$ mixture distribution analysis was done using the three factors; class (group 1 vs. group 2), sub-unit (rectangles vs. triangles and parallelograms vs. trapezoids and rhomboids), and problem type (necessary problem vs. extraneous information problem).

As a result of the distribution analysis, the main effects that were significant were: class ($F_{(1,74)}=4.80$, $p<.05$), sub-unit ($F_{(2,148)}=6.99$, $p<.01$), class \times sub-unit interaction ($F_{(2,148)}=3.63$, $p<.05$), problem type ($F_{(1,74)}=17.39$, $p<.01$), sub-unit \times problem type interaction ($F_{(2,148)}=5.70$, $p<.01$), and class \times sub-unit \times problem-type interaction ($F_{(2,148)}=3.23$, $p<.05$).

To compare classes in more detail, we conducted lower-order testing using the Bonferroni method for class \times sub-unit interaction. There was no difference in scores between classes for "rectangle" and "triangle and parallelogram", but there was a significant difference in scores for both classes for "trapezoids and rhomboids" ($F_{(1,74)}=7.80$, $p<.01$), and group 1, which worked with SPT, clearly had higher scores.

For the two sub-units that showed no difference between classes, both classes had used SPT, but for the sub-unit that showed a difference between classes, trapezoids and rhomboids, only group 1 used the SPT. This suggests that using the SPT promoted schema formulation, and as a result, this had the effect of raising problem solving scores.

The two classes have different teachers, so there are potential differences in their teaching technique to result in differences between the classes, but if differences in their technique alone were a cause, there should have been differences in the first and second written tests as well, but this was not observed. In other words, for both practices where SPT was used, the teachers were also teaching effectively. Based on the above consideration, we can say that using SPT continually while teaching the units effectively promotes schema formulation and problem solving itself.

5.3 Effects of SPT on Learning Processes of Children Weak in Arithmetic

Next, we examined in detail, the sort of students on which SPT has the greatest effect. We compared changes in scores for students weak in arithmetic, who regularly received attention from teachers (designated "marked students" or MS), with those of other students ("unmarked students", US). The average frequency of use for group 1, consisting of 9 MS and 29 US, was 9.8 times and 11.5 times respectively. For group 2 with 4 MS and 35 US, it was 4 times and 3.6 times respectively.

The scoring trends on paper tests for MS and US in each class are shown in Fig. 9 and Fig. 10. Comparing the test scores from MS and US in group 1 for three paper tests, showed no significant difference. In other words, when using SPT continuously while teaching, children weak in arithmetic were also able to understand the study materials adequately.

In contrast, a significant difference was observed between MS and US in group 2 ($t_{(25)}=-5.3$, $p<.01$). The graph shows clearly that the difference increased as learning progressed. This result shows

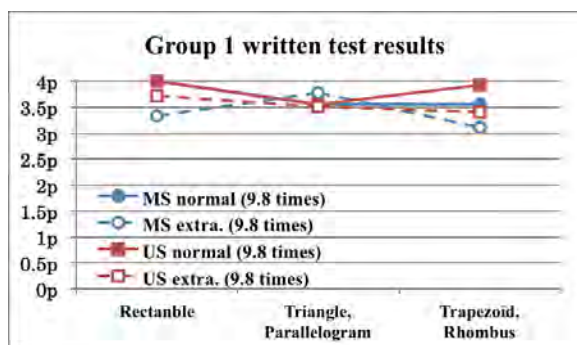

Figure 9. Mean Scores of Paper Test (US and MS in the Class1)

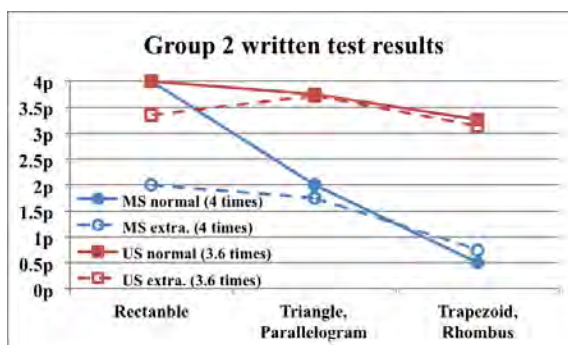

Figure 10. Mean Scores of Paper Test (US and MS in the Class2)

that in the class using SPT less frequently, children weak in arithmetic were not understanding the learning materials adequately.

The above analysis shows that using SPT is effective for schema formulation, but such results are not likely to be obtained simply by embedding the SPT. A major factor besides this could be that embedding SPT and conducting small tests for each sub-unit increases the opportunities for the teacher to understand the students' progress.

This suggests that schema formulation and improvements of teaching activities due to SPT operation result in the following synergies.

1. SPT is helpful for the teacher to know students' level of understanding, and this promotes teaching.
2. Engaging in SPT promotes schema formulation in the students. The effect on schema formulation was large for MS in particular, from the analysis of MS and US.

5.4 Results of Teacher and Student Questionnaires

We now mention the results of interviews and surveys given to teachers and students. The results of teacher interviews are summarized in Table 1.

Regarding effectiveness in motivating study, teachers felt that, judging from the students' behavior, students found the system easier to use and were less opposed to using it than to studying with text books or problem sets, and this increased motivation. The student survey results also suggested this.

A survey was conducted with items as shown in Table 2 and answers using a five-rank score (strongly agree, somewhat agree, I don't know, somewhat disagree, strongly disagree). The results are shown in Fig. 11. The overall results were quite positive.

From questions 1, 2, and 5, students used the system without difficulty, and enjoyed working with it even though the type of question in SPT was unusual: deciding whether problems were valid or not.

Questions 3 and 4 suggest that students themselves found that the system was helpful for

Table 1. Interviewing Results from 2 Teachers

Usefulness for Motivating Study	
	• Students happily said, "I want to try, I want to try!" and were very willing. The number of students consulting with the teacher and other students increased.
	• Frequency of system use depends on personality. Low level students showed perseverance, saying things like "I just want to get one more right!" Low level students really seemed to make progress. As not seen before, students showed overflowing confidence at the
Course practice reflecting students' level of understanding	
	• Written tests including problems with extraneous information were a good stimulus. For example, asking "Where is the height in this figure?" has been incorporated into the class.
Introduction into classes, usage issues	
	• Opportunities to use the teacher system in order to identify students weak in arithmetic and give them attention were few. However, it appeared to be useful for making arrangements in class based on overall trends (e.g. whether to hold a review class, or to provide personalized attention).
	• We only allowed use under supervision by teachers, so management was difficult, and this may have been inconvenient for the children.
	• We felt it may be more convenient to have one terminal per student.
	• The system would have been used more if students were required to use it more.

learning, and they see this effect positively as well.

Question 6 indicated that many students would like to use SPT again in the future, suggesting that SPT materials could be expanded to include other units that students would accept, making it a more useful tool.

For question 7, regarding motivation to study arithmetic, 56% of students responded that studying arithmetic was more fun (34% for strongly agree, 22% for somewhat agree), suggesting that using the system contributes to increasing motivation to study arithmetic.

The survey results from only MS are shown in Fig. 12. It also shows the same, mainly positive trend for MS. The analysis in 5.3 suggested that the system is useful for schema formulation in students thought to be weak in arithmetic, but for question 7 in particular, 62% of MS responded for themselves that studying arithmetic was more fun (46.1% strongly agree, 15.4% somewhat agree), so this is also a very significant result.

Table 2. Questionnaire Items for Students

- | |
|--|
| 1. Was the schema game fun? |
| 2. Was the schema game simple? |
| 3. Do you think you learned arithmetic in the schema game? |
| 4. Do you think you learned to solve area problems more easily by playing the schema game? |
| 5. Was it easy to use the schema game? |
| 6. Do you want to play the schema game again? |
| 7. Did it make studying arithmetic more fun? |

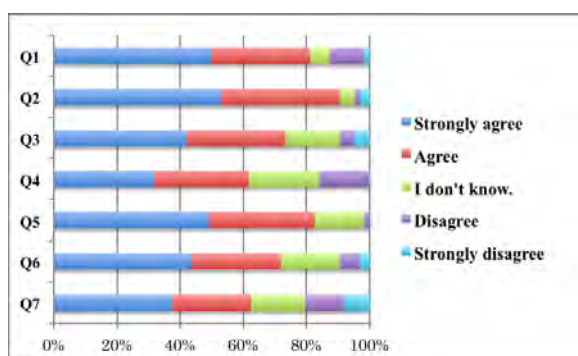

Figure 11. Questionnaire Results (US and MS)

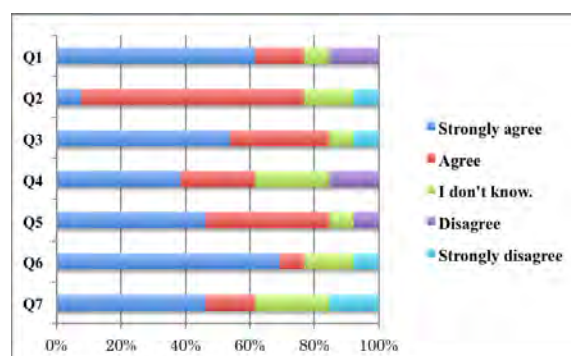

Figure 12. Questionnaire Results (MS only)

6. Concluding Remarks

This paper describes a system for assessing learners' schema formulation easily, and reports on long-term use of this system in an elementary school. The results, from the perspective of the usefulness of the developed system, are: (1) the group using the system more frequently may have had better schema formulation than the group using it less frequently, (2) differences in written test results between classes due to having done or not done the SPT were confirmed, and (3) differences in number of times used clearly produced large differences in scoring trends for MS.

We also confirmed that the system developed in this research can be used in a way that integrates with teaching when introduced into the classroom. The system also operated with stability, not going down once over an experimental study of one month. By implementing a tool that reduces difficulties faced by many students on a mobile terminal in this way, even elementary students can enjoy engaging in learning. Since it is easy to embed into classrooms, which have strong time constraints, and has been shown to be stable through real operation, it also demonstrates a possible operational model, which is another research result.

One issue with introducing and using the system in classrooms was that we could not provide enough number of terminals. We tried to compensate for this, but increasing the number of terminals should be considered to encourage more-active use of the system. On the other hand, the system was implemented on iPod Touch terminals, which are less expensive than PCs or other types of tablet terminal, so cost related difficulties are relatively small-scale with this implementation.

In elementary schools, which are classroom-based, the class teacher is aware of students requiring particular care, so in this case the teacher's system was hardly used at all. Thus, looking only at these results suggests there is not a strong need for it in the primary classroom. On the other hand, we

received a comment that it may be more useful in middle and high-school, which are course-based, so we would like to evaluate usefulness of the system for teachers in secondary education.

Future issues include (1) building a process model of students' comprehension (e.g.: knowledge of a unit is not organized sufficiently because other applicable units are inadequate) through continual use of the system, and (2) developing functionality to give feedback to students based on this information.

References

- Tsukasa Hirashima, Takuro Yokoyama, Masahiko Okamoto, Akira Takeuchi: A Computer-Based Environment for Learning by Problem-Posing as Sentence-Integration, ICCE2006, pp.127-130
- Sho Yamamoto, Takuya Hashimoto, Takehiro Kanbe, Yuta Yoshida, Kazushige Maeda, Tsukasa Hirashima: Interactive Environment for Learning by Problem-Posing of Arithmetic Word Problems Solved by One-step Multiplication, Proc. of ICCE2013, pp.51-60, (2013)
- Tomoya Horiguchi, Isao Imai, Takahito Toumoto, Tsukasa Hirashima, "A Classroom Practice of Error-based Simulation as Counterexample to Students' Misunderstanding of Mechanics", Proc. of ICCE 2007 (2007), pp.519-525, (2007)
- Akihiro Kashihara and Naoto Akiyama: Learner-Created Scenario for Investigative Learning with Web Resources, Proc. of the 16th International Conference on Artificial Intelligence in Education (AIED 2013), pp. 700-703, Springer, Memphis, USA (2013).
- Koichi Ota, and Akihiro Kashihara: Mining Collective Knowledge for Reconstructing Learning Resource, Proc. of ICCE 2010, Putrajaya, Malaysia, pp.104-106, (2010).
- Corentin Jouault and Kazuhisa Seta: Adaptive Self-Directed Learning Support by Question Generation in a Semantic Open Learning Space, Int. J. of Knowledge and Web Intelligence, 2014, to appear
- Corentin Jouault and Kazuhisa Seta: Content-Dependent Question Generation for History Learning in Semantic Open Learning Space, Proc. of 12th International Conference on Intelligent Tutoring Systems, (2014, to appear)
- Ryo Okamoto, Yuto Watanabe, and Akihiro Kashihara: Review Support System with Visual-Oriented Annotation Method for Presentation Rehearsal, Proc. of the 21st International Conference on Computers in Education (ICCE2013), pp. 295-297, Bali, Indonesia, 2013
- Yasuo Shibata, Akihiro Kashihara, and Shinobu Hasegawa: Skill Transfer from Learning to Creating Presentation Documents, ITHET2013 (International Conference on Information Technology Based Higer Education and Training), ISBN: 978-1-4799-0086-2, Antalya, Turkey, 2013
- T. Kojiri and N. Iwashita: Visualization of Slide Relations for Supporting Presentation Speech Preparation, Proc. of the 21st International Conference on Computers in Education, pp.1-10 (2013)
- Kazuhisa Seta, Liang Cui, Mitsuru Ikeda, Noriyuki Matsuda, Masahiko Okamoto: Meta-Cognitive Skill Training Program for First-Year Bachelor Students Using Thinking Process Externalization Environment, Int. J. of Knowledge and Web Intelligence, Vol. 4, No. 2, pp. 217-237, (2013)
- Kazuhisa Seta, Daijiro Noguchi, Mitsuru Ikeda: Presentation-Based Collaborative Learning Support System to Facilitate Meta-Cognitively Aware Learning Communication, The Journal of Information and Systems in Education, Vol. 9, No.1, pp.3-14, (2011)
- Akiko Deguchi, Etsuji Yamaguchi, Hideo Funaoi and Shigenori Inagaki: Concept Mapping Software to Reconstruct Learning Processes: Enhancement Based on the Teacher's Requests and Its Evaluation from the Viewpoint of Teachers, Proc. of ICCE 2004, pp. 935-940, (2004)
- Etsuji Yamaguchi, Hideo Funaoi, Shigenori Inagaki, Akiko Deguchi, Naohisa Misawa, and Shinichi Kamiyama: Enhancement of the Digital Fortune Line System for Accelerating Mutual Examination of Learners' Conceptual Ecologies, Proc. of ICCE
- Masahiko Okamoto: The Study of Metacognition in Arithmetic Word Problem Solving, Kazama-shobo Publishing Tokyo, (1999) (in Japanese)
- Richard E. Mayer: "Memory for algebra story problems," Psychological Review, Vol.92, No.1 pp.109-129, 1985
- Denise D. Cummins, Walter Kintsch, Kurt Reusser, Rhonda Weimer: "The role of understanding in solving word problems," Cognitive Psychology, 20, pp.405-438, 1988

Visualization for Analyzing Ubiquitous Learning Logs

Kousuke Mouri¹, Hiroaki Ogata², Noriko Uosaki³, SongRan Liu⁴

^{1,2}*Faculty of Arts and Science and the Graduate School of Information Science and Electrical Engineering, University of Kyushu, Japan*

³*Center for International Education and Exchange, Osaka University, Japan*

⁴*Advanced Technology and Science, University of Tokushima, Japan*

*{mourikousuke, hiroaki.ogata, n.uosaki, lb90518}@gmail.com

Abstract: This paper describes a system that can be used to visualize some ubiquitous learning logs to grasp and discover several learning flow and timing. Visualization of the system is based on vast amount of learning data in ubiquitous learning environment. Ubiquitous Learning Log (ULL) is defined as a digital record of what learners have learned in the daily life using ubiquitous technologies. It allows learners to log their learning experiences with photos, audios, videos, location, RFID tag and sensor data, and to share and to reuse ULL with others. This paper will reveal about the relationship between the ubiquitous learning logs and learners by using network graph. Also, this paper will explicate the system through which learners can grasp their learning time, histories, knowledge and location.

Keywords: ubiquitous learning, network graph, time-map, information visualization

1. Introduction

Recently, researchers in the educational engineering area have been studying focusing on ubiquitous themes. For example, CSUL (Computer Supported Ubiquitous Learning) or context aware ubiquitous learning (u-Learning) have been constructed using computing technologies such as mobile devices, QR-code, RFID tag and wireless sensor networks (Hwang et al., 2008; Ogata & Yano, 2004). These learnings take place in a variety of learning space such as classroom, home and museum. Also, the cutting-edge technologies can provide the right information using the contextual data like location, surrounding objects and temperature.

Therefore, many researchers have been focusing on effective learning with ubiquitous technologies. We have developed ubiquitous learning system called SCROLL (System for Capturing and Reminding of Learning Log) (Ogata et al., 2011). The system will support international students to learn their target languages. Traditionally, international students take memos when they have learned something in their daily lives. However, if the notes have not been taken in detail, they can neither actively recall what they have learned, nor the location where they learned them. Therefore, we have proposed SCROLL which enables learners to recall their past learning experiences by saving them to the system with location, photo, or video as digital records.

Also, these learning dataset include spatiotemporal data. Spatiotemporal data usually contain the states of an object, an event or a position in space over a period of time. These datasets might be collected at different locations, various time points in different formats. It poses many challenges in representing, processing, analysis and mining of dataset due to complex structure of spatiotemporal objects and the relationships among them in both spatial and temporal dimensions (K.Venkateswara Rao et al., 2011, 2012).

Similarly, it poses many issues about relationship between the learners and the ubiquitous learning logs due to complex structure of the ubiquitous learning logs in SCROLL. In addition, it is important for learners to recognize what and how they have learned by analyzing and visualizing the past ULLs, so that they can improve what and how to learn in future (Ogata et al., 2011). To tackle these issues, it is necessary to reveal relationships between the learners and the ubiquitous learning logs.

Therefore, this paper proposes a method to visualize relationships between the learners and the ubiquitous learning logs using Time-map and network graph. The objective of this study will reveal how the learners learned language in their daily lives. Therefore, this paper will visualize learning data collected from SCROLL, and as next step will analyze them.

2. Related Works

2.1 Learning Analytics and Knowledge

In recent years, Learning Analytics and Knowledge (LAK) has been drawing an attention from researchers of such fields as educational engineering, information science and network science. To date, Course Management System (CMS) and Learning Management System (LMS) enabled us to record learners' access logs onto server. The Learning Analytics (LA) aims for practical use based on learning mechanisms revealed by visualizing, mining and analyzing vast amount of learning data (Ferguson 2012). This paper focuses on the Social Learning Analytics (SLA), a subset of the LAK (Buckingham 2012). The SLA puts forward presenting appropriate information to learners at the appropriate timing through the Dashboard in real time. As a new challenge, this paper aims to reveal about relationships between learners and learning logs on spatiotemporal fields.

Therefore, this paper is expected to contribute to educational improvement and strategies below.

- This study facilitates the analysis of learners by visualizing all data on spatiotemporal.
- This study enables future prediction about learners and learning environment from visualized learning logs.

2.2 Time-map

Time-map is a library of javascript, which collaborated with Google map and SIMILE (Semantic Interoperability of Metadata and Information in unLike Environments) TimeLine (SIMILE project). SIMILE focuses on developing robust, open source tools that empower users to access, manage, visualize and reuse digital assets. The time-map function means that the user can scroll the timeline and then the Google map will display the learning logs recorded during learners' selected period. It is designed to help learners to reflect what they have learned. For example, if a learner clicks his learning logs on timeline, Google map will display their positions as shown in Figure 1. After visualizing log information, Time-map will facilitate learners to reflect on their logs with spatio and temporal information. They are able to grasp their learning context and time zone. Also, it is a possibility that the geographic information is a clue of recalling what they have learned.

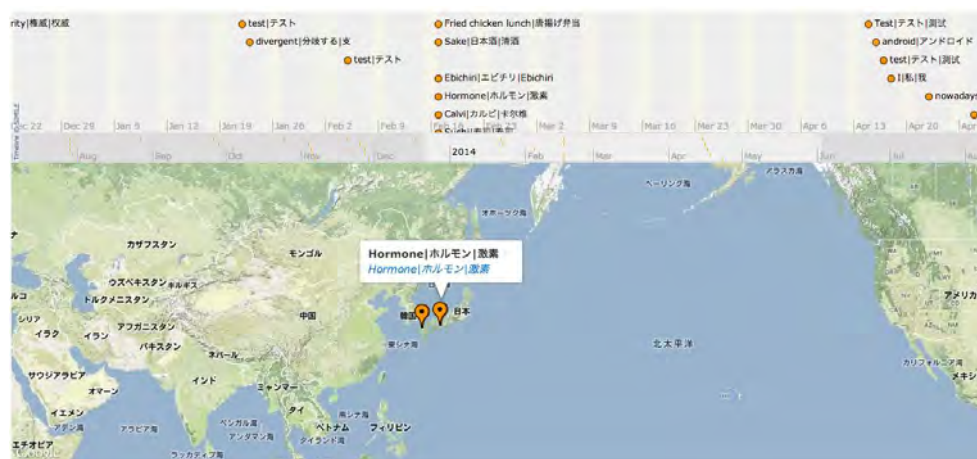

Figure 1. Time-map

3. Design of the system

3.1 SCROLL

With the evolution of the mobile device, people prefer to record learning contents using mobile devices instead of taking memos on paper. Most of the language learners have their own learning notes. In this paper, learning log is defined as a recorded form of knowledge or learning experiences acquired in our daily lives.

One of the objectives of SCROLL is to support international students in Japan to learn Japanese language from what they have learned in formal and informal setting. It adopts an approach of sharing user created contents among users and is constructed based on a LORE (Log-Organize-Recall-Evaluate) model which is shown in Figure 2 (Ogata et al., 2011).

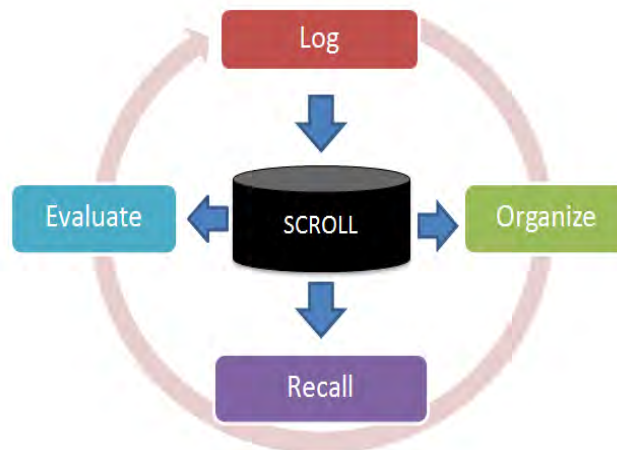

Figure 2. LORE model in SCROLL

SCROLL is a client-server application, which runs on different platforms including Android mobile phones, PC and general mobile phones shown in Figure 3. The server side runs on Ubuntu 12.04.2 and it is programming using Java, Spring MVC and Mybatis. The developed software for Google phone is a native java application based on Android SDK (Li et al., 2012).

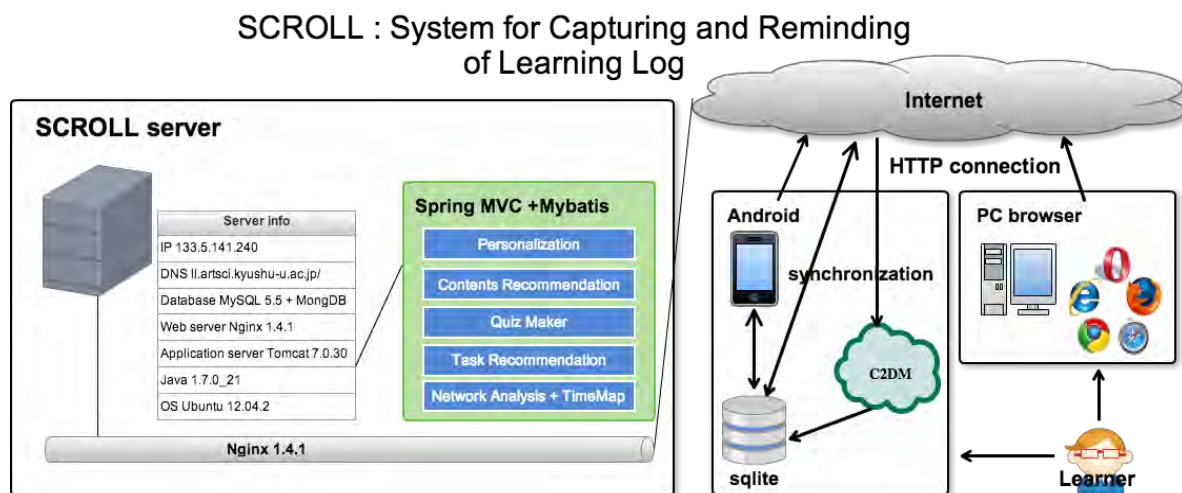

Figure 3. The architecture of SCROLL

3.2 Collecting a ubiquitous learning log on SCROLL

The learners can record some learning language such as English, Japanese and Chinese with a photo using android device and SCROLL as shown in Figure 4. Figure 5 shows a learning log on android device.

The learning log includes meta-data such as author, language, created time, location (latitude and longitude) and tag. The learners will record or review a learning log using these functions on android device. Such iterative learning is supported by our quiz function on SCROLL. There are three types of quizzes generated automatically by the system, which are yes/no quiz, text multiple-choice quiz and

image multiple-choice quiz. Figure 6 shows an image multiple-choice quiz interface generated automatically based on the meta-data of ULLs.



Figure 4. Learning note



Figure 5. A learning log

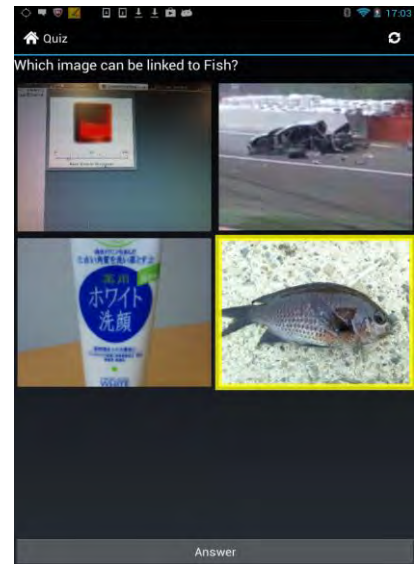

Figure 6. Quiz

3.3 Structure based on network graph in SCROLL

To reveal several relationships between the learners and knowledge or knowledge and location, we have uniquely defined them as three-layers structures as shown in Figure 7.

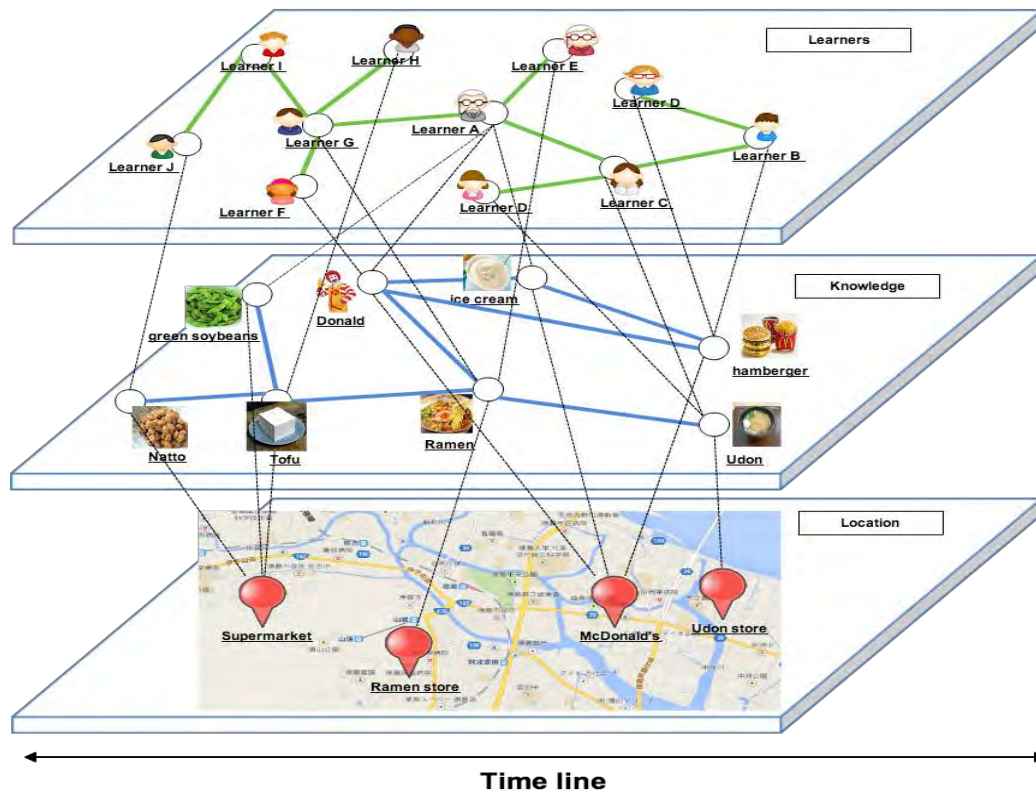

Figure 7. Three-layer structure in SCROLL

The upper layer contains each author in order to confirm position of own or other learners. The intermediate layer contains the knowledge that learners learned. Also, some fields of learning tasks can be included in this layer. For example, some task-based learning in ubiquitous learning environment can be carried out using knowledge and event (Mouri et al., 2013; Sharon 2013). The

scalability of the layers can be enhanced and the field of visualization can be widened by linking one's own learning logs to the knowledge learned by doing tasks.

The lowest layer contains data such as location and time. In order to realize spatiotemporal visualization of our learning logs, nodes on the intermediate layer are linked to the nodes on the lowest layer.

Analysis by categorizing three-layers has following advantages:

- Places with a large number of links to the related knowledge are the places where they can learn a lot of knowledge. For example, if a certain supermarket or convenience are related with a lot of knowledge such as natto, green soy beans, tofu, miso soup, and cup noodle, by analyzing relationships between the knowledge and the location the System can provide learners with a valuable learning information.
- Knowledge which is related to many places is the knowledge which we can learn in various places. For example, if a learner experience tea ceremony of a traditional Japanese culture at the university in Japan, a set of tea ceremony related knowledge (eg. tea, seize: to sit in the correct manner on a Japanese tatami mat) can be learned in other various places. The tea can be learned by purchasing at the supermarket and the seiza can be learned at the martial art gym.

4. Implementation

This section describes ways of the implementation of the system for visualizing the three-layer structure using network graph and Time-map.

4.1 System for visualizing network graph in SCROLL

4.1.1 How to create node or connect edge on three-layers

Firstly, system for visualizing network graph will create authors' node on the upper layer. To date, the number of learners in SCROLL is approximately three thousand people.

Secondly, the system will create knowledge node on the intermediate layer. Then, the system will connect authors' node related to knowledge node that learners have learned. For example, if learner A learned a learning log like “natto (a traditional Japanese food made from fermented soybeans)”, “tofu (bean curd)” and “sushi”, the system will connect "learner A" of node on the upper layer to "natto", "tofu" and "sushi" on the intermediate layer.

Thirdly, the system will create location node on the lowest layer. Then, the system connect knowledge node on the intermediate layer to node of the location on the lowest layer. For example, if the learner A have learned knowledge of "natto" at the supermarket in Japan, the system will connect "natto" on the intermediate layer to the latitude and longitude of "supermarket" on the lowest layer.

4.1.2 Color of visualized nodes

The learners might get confused when they recognize past learning logs because there might be too many of visualized nodes. Therefore, it is definitely necessary to establish some criteria for distinction of each node. To effectively distinguish kind of each node, we defined as Table 1 below using node color.

Table 1: Color to distinguish the kinds of nodes

Node	Layer	Node color
Learner's own name	Upper layer	Pink
Names of other learners	Upper layer	Blue
Knowledge of learners	Intermediate layer	Yellow
Location of learners	Lowest layer	Red

- Pink color node shows the learner's own name on the upper layer. If connecting the pink node to yellow node on the intermediate layer, edge color will be decided as pink so that they can be easily recognized as the learner's own logs.
- Blue color nodes show the names of other learners on the upper layer. If connecting the blue node to yellow color node on the intermediate layer, edge color is decided blue color.
- Yellow nodes represent both the learner own knowledge and the knowledge of other learners. For example, the learner can recognize his own knowledge because edge between the learner own name on the upper layer and the knowledge on the intermediate layer is pink color. In addition, the learner might discover knowledge of other learners related to own knowledge.
- Red color node shows the location of learners on the lowest layer. The node includes latitude, longitude and created time.

4.2 Combining network graph and Time-map

The interface of the network graph on web browser is shown as Figure 8. The learners can recognize relationships between own/others author and knowledge by using the network graph interface. The learners' node (red or blue node) on the network graph is connected to many knowledge (yellow node) in accordance with node color. The network layout consists of using Yifan Hu multilevel layout (Y.F Hu, 2001, 2005).

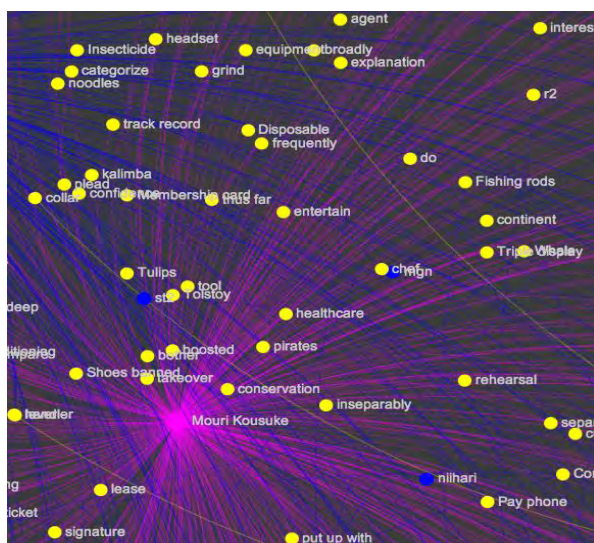

Figure 8. Network graph on web browser

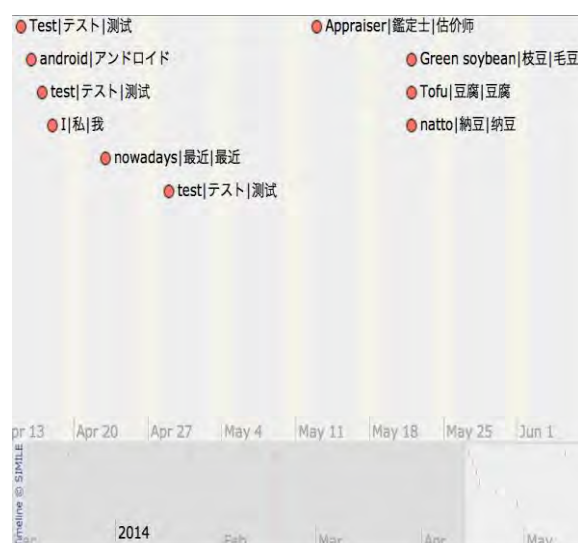

Figure 9. Time line on web browser



Figure 10. Time-Map on web browser

It is a very fast algorithm with a good quality on large graphs. It combines a force-directed model with a multilevel algorithm to reduce the complexity. The repulsive forces on one node from a cluster of distant nodes are approximated by a Barnes-Hut calculation (Barnes and P. Hut., 1986), which treats them as one super-node.

The interface of Time-map on web browser is shown as Figure 9, 10. Figure 9 shows the sample of learners' timeline. It represents the shift of learning history in accordance with lapse of time. The learners might forget the learning logs when and where they have learned before. Therefore, the system can remind the learners of them by combining timeline with map as shown in Figure 10.

We have developed the system for visualizing who is learning what, and when, where and how by combining these interfaces. The learners will find it useful with the following respective reasons.

- The learners can be aware of relationship between their own knowledge and other knowledge. The new knowledge can be found easily by viewing the network graphs.
- The system will remind them of their learning logs recorded during the specified period of time by showing them on the timeline (default: two month before and after the setting time). Besides, the system will lead them to be aware of knowledge recorded right before or after the knowledge of their interest which was recorded by other learners. Therefore, it will give them a clue on what to learn next. For example, if learner A learned a natto at the supermarket, there is a possibility that learner B had already learned it. When the learner B learned a natto, he/she might have learned other natto related words such as tofu and green soybeans. Natto related words which learner B had learned would be recommendable learning contents for learner A. That way learners can learn their target language more effectively using visualized information.

5. Evaluation

5.1 Method

Eight international students studying at the university of Tokushima and Kyushu participated in the evaluation experiment. Participated students were from China aged between 21 and 34. Their length of stay is from 1 month to 5 years. The participant information is shown in Table 2.

Before the evaluation started, we explained about how to use the system for visualizing learning logs to them. They've never used SCROLL. Therefore, they used SCROLL for one day before using system for visualizing learning logs. They at least recorded five learning logs one day, and then they recorded learning logs using our proposed system for one week. After the evaluation, the participated students were asked to fill in a five-points-scale questionnaire, and they have evaluated the performance, usefulness and learning effectiveness on this system.

Table 2: Detail of students

	Age	Gender	Length of stay
Student A	24	Male	2 years
Student B	26	Male	2 years
Student C	21	Male	2 years
Student D	34	Male	5 years
Student E	23	Male	1 months
Student F	23	Male	1 months
Student G	23	Female	1 years
Student H	25	Female	7 months

5.2 Result and discussion

The questionnaire results are presented in Table 3.

Q1-Q5 are the questions to ask its usability and usefulness of our network graph. Q6-Q9 are the questions to ask the importance and performance of the system combining the Time-map and the network graph.

From the results of Q1 and Q2, it reveals that the learners were able to efficiently grasp their own or others' knowledge using the network graph for visualizing learning log.

Q3 result indicates that the learners were able to grasp similar knowledge between their own knowledge and other knowledge. Q4 result indicates that they were able to grasp knowledge using different color. When they found other learners or knowledge, the most of students recognized them from nodes' color. Therefore, it was effective to distinguish other learners and learning log by color. Q5 result indicates that network graph of the system was useful.

Q6 and Q7 results indicate that the learners were able to discover other interesting learners or knowledge that they didn't know. When the learners discovered new knowledge or other learners, what they had discovered is shown in table 4. Table 4 shows the multiple-choice questionnaire. Most of them discovered the knowledge from the process number 2. This is because the learners were able to discover the knowledge in this system thanks to visualizing all learning logs.

Q8 resulted in the lowest average score in questionnaire. This seems to be because that effectiveness comes not only from grasping their own learning trend. Therefore, the system needs to recommend appropriate learning trend from other learners' learning trend in future. For example, if learner A learned the "natto" in the supermarket, and learner B already might have learned the "natto" at different or same location. After learner B learned "natto", he/she might have learned continuously some related words such as green-soybeans and tofu. Similarly, after the learner C learned the "natto", he/she might have learned some related word such as rice and soy sauce. Therefore, it is useful in future that the learners can be aware of next learning trend by other learners' trend being recommended.

Q9 result indicates that the learners were able to recall the knowledge using the system combining the network graph and Time-map.

Table 5 lists the open-ended comments of the participants about the problem they found using the system and their suggestions for the improvement of the system.

It was suggested that improving UI (User Interface) design and function would be helpful to recognize their knowledge. Taking these issues into account, our future works will be described in the next section.

Table 3: Result of the five-point-scale questionnaire

Question	Mean	SD
1. Were you able to grasp your own knowledge using network graph?	4.50	0.50
2. Was this system useful to find new knowledge?	4.62	0.48
3. Were you able to recognize relationship between yourselves and other learners?	4.12	0.59
4. Were you able to grasp whole knowledge and your own knowledge by the node color?	4.25	0.66
5. Was network graph of the system useful?	3.87	0.92
6. Were you able to discover knowledge of interest on Time-map and other learners' knowledge?	4.62	0.48
7. Were you able to distinguish one learner from another and to discover interesting learner?	3.37	1.40
8. Was it important to grasp your own learning trend on Time-map?	2.87	1.45
9. Were you able to recall the knowledge when and where you have learned by using system for visualizing learning log with Time-map?	4.5	0.70
10. Please rate on a five point scale how much it helped you to grow your Japanese/English vocabulary.	4.37	0.48
11. Please rate on a five point scale how much it helped you to improve your Japanese (English) ability.	4.37	0.48

Table 4: The process of discovery of knowledge and other learners

Process	Total (8/8)
1. The learners randomly chose one from all of nodes.	3/8
2. The learners discovered interesting knowledge by chance.	6/8
3. The learners discovered it because their own knowledge and other learners' knowledge were same knowledge.	3/8
4. The learners discovered some knowledge from other learners (blue node).	2/8
5. Other (Free description)	0/8

Table 5: User comments

Users' suggestions (Open-end questionnaire)
1. It is very easy to use. I was able to find new knowledge.
2. I think that you should improve the UI design on network graph. It was the complex screen.
3. There were too many learners on interface, so it would be confusing. I think that you need to improve it.
4. The interface is difficult to understand.

6. Conclusion and Future work

This paper described the system for visualizing relationships between the learners and the learning logs. International students can add their knowledge as the learning log in SCROLL, and then SCROLL can provide learning contents to recall what they learned based on their learning contexts. By using the system that we proposed, the international students can discover the knowledge related to others learners and the interesting knowledge. The initial evaluation was conducted after implementing the function to visualize the learning logs and the learners. Five-point-scale questionnaire conducted after the evaluation shows that the system supported the international students by visualizing the learning logs. As mentioned in section 5.2 results and discussion, it needs improvement of its UI design and functions. Therefore, we will improve the system by excepting useless knowledge using filtering function.

In the future, we will develop a new function so that the system can analyze various situations focusing learning analytics such as network analysis (Freeman 1978; Shane 2014), decision tree (Bitner 2000) and association rule (Florian 2005). In addition, we will consider quantitative measures and user self-reported data when evaluating the function.

Acknowledgements

Part of this research work was supported by PRESTO from Japan Science and Technology Agency, and the Grant-in-Aid for Scientific Research No.26350319 from the Ministry of Education, Culture, Sports, Science and Technology (MEXT) in Japan.

References

- Bitner T. (2000). Rough sets in Spatiotemporal data mining, Proceedings of International workshop on Temporal, Spatial and Spatiotemporal Data Mining, Lyon, France.
- Buckingham, S.S & Freguson, R. (2012). Social Learning Analytics, Journal of Educational Technology & Society, 15 (3), 3-26.
- Florian, V., & Sanjay, C. (2005). Mining Spatio-Temporal Association Rules, Source, Sinks, Stationary Regions and Thoroughfares in Object Mobility Databases, Technical Report Number 574, the university of Sydney, 187-201.
- Freeman, L.C. (1978). Centrality in social networks conceptual clarification, Social Networks 1, 3, 215-239.

- Ferguson, R. (2012). The State of Learning Analytics in 2012: A Review and Future Challenges, Technical Report KMI-12-01, Knowledge Media Institute, The Open University, UK.
- Hwang, G. J., Tsai, C. C., & Yang, S. J. H. (2008). Criteria, strategies and research issues of context-aware ubiquitous learning. *Educational Technology and Society*, 11(2), 81-91.
- J. Barnes and P. Hut. (1986). A Hierarchical $O(n \log n)$ Force-Calculation Algorithm, *Nature*, 324(4), 446-449.
- K.Venkateswara R, A.Govardhan & Dr.K.V.Chalapathi R. (2011). Discovering Spatiotemporal Topological Relationships, The second international workshop on Database Management Systems, DMS-2011, Springer Proceedings LNCS-CCIS 198.
- K.Venkateswara R & A.Govardhan. (2012). Spatiotemporal data mining: Issues, Task and Applications, *International Journal of Computer Science and Engineering Survey*, Vol.3, No.1, Feb2012, 39-52.
- Li, M., Ogata, H., Hou, B., Uosaki, N., & Yano, Y. (2012). Personalization in Context-aware Ubiquitous Learning-Log System, *Mobile and Ubiquitous Technology in Education*, 41-48.
- Mouri, K., Ogata, H., Li, M., Hou, B., Uosaki, N., & Liu, S. (2013). Learning Log Navigator: Supporting Task-based Learning Using Ubiquitous Learning Logs, *Journal of Research and Practice on Technology Enhanced Learning (RPTEL)*, 8(1), 117–128.
- Ogata, H., & Yano, Y. (2004). Context-aware support for computer-supported ubiquitous learning. *Proc. of IEEE International Workshop on Wireless and Mobile Technologies in Education*, 27-34.
- Ogata, H., & Yano, Y. (2004). Knowledge awareness map for computer-supported ubiquitous language-learning. *Proc. of IEEE International Workshop on Wireless and Mobile Technologies in Education*, 19-26.
- Ogata, H., Li, M., Bin, H., Uosaki, N., El-Bishoutly, M., & Yano, Y. (2011). SCROLL: Supporting to share and reuse ubiquitous learning logs in the context of language learning. *Research and Practice on Technology Enhanced Learning*, 6 (3), 69-82.
- Sharon, A. (2013). Storyline: A task-based approach for the young learner classroom, *ETL journal*, 67(1), 41-51.
- Shane, D., Dragan, G., George, S., & Srecko, J. (2014). Current State and Future Trends: A Citation Network Analysis of the Learning Analytics Field, *International conference on Learning Analytics and Knowledge (LAK)* ACM, 231-240.
- SIMILE project: <http://www.simile-widgets.org/timeline/>
- Y. F. Hu & J. A. Scott. (2001). A Multilevel Algorithm for Wavefront Reduction, *SIAM Journal on Scientific Computing*, 23(4), 1352-1375.
- Y. F. Hu. (2005). Efficient and high quality force-directed graph drawing, *The Mathematica Journal*, vol. 10, 37–71.

A Context-aware Dynamical Learning Environment for Multiple Objectives

Min CHEN^a, Feng-Kuang CHIANG^b, Sheng-Quan YU^{c*}

^a*Faculty of Education, Beijing Normal University, China*

^b*Faculty of Education, Beijing Normal University, China*

^c*Faculty of Education, Beijing Normal University, China*

* yusq@bnu.edu.cn

Abstract: In a real ubiquitous learning environment, different learners may have different learning objectives; a learner also has different objectives in different periods. Ubiquitous learning environment should be able to support different learning objectives. However, most of ubiquitous learning environments are designed for specific learning objectives, in which all learners only get learning resources related to the specific learning objectives with fixed contents. This research proposes a ubiquitous learning environment to support different learners' learning with different learning objectives at same time. This environment is called CDLEMO (Context-aware Dynamic Learning Environment for Multiple Objectives). It can provide available and suitable learning resources, and the contents of a resource can be adjusted dynamically according to learning objective. The results of a pilot experiment conducted in the botanical garden in Beijing Normal University show that CDLEMO can make learning become more convenient and fun, enhance learning motivation, stimulate learning interest, and it wins the learners' acceptance and approval.

Keywords: Ubiquitous Learning Environment, Context-aware, Learning Objective, Learning Resource, Learning Content

1. Introduction

Ubiquitous Learning has become an important direction of the next generation of e-Learning (Ley, 2007; Chu, Hwang, Huang and Wu, 2008; Hwang, Yang, Tsai and Yang, 2009; Hwang, Wu, Tseng and Huang, 2011). A growing number of researchers do researches in this field, especially in ubiquitous learning environment (Hwang, Tsai, and Yang, 2008; Hwang, Yang, Chin and Stephen, 2009; Feeney, Ahgre, and Westerlund, 2001; Kindberg and Fox, 2002). How to realize learners timely access to the needed learning resources anytime and anywhere is one of the most important research issues in the era of ubiquitous learning (El-Bishouty, Ogata and Yano, 2007; Shih, Chu, Hwang and Kinshuk, 2011). In a real environment, different learners may have different learning objectives, and different learning objectives need different learning resources and contents. But now most ubiquitous learning environments are designed without considering learning objective, so the learning resources in those environments are static and contents of learning resources cannot be adjusted according to learning objective.

Aiming at the problem that current ubiquitous learning environments are difficult to support a variety of learning objectives at the same time, this study proposes a ubiquitous learning environment, named context-aware dynamic learning environment for multiple objectives (CDLEMO). CDLEMO consists of learning resource space, context-awareness system and learning resource aggregation system. CDLEMO can provide learner learning resources with suitable content according to his learning objective and location. In addition, this study does a pilot study, and then interviews the participants to understand their recognition and acceptance of CDLEMO.

2. Relevant works

At present, there are more and more researches on ubiquitous learning environment. From the two perspectives of learning resource and learning objective, we divide current ubiquitous learning environments into ubiquitous learning environment with static resources for single objective, ubiquitous learning environment with personalized static resources for single objective, and ubiquitous learning environment with personalized static resources for multiple objectives.

In the ubiquitous learning environment with static resources for single objective, all learners will obtain the same learning resources, the contents of which all are static. For example, a ubiquitous learning environment for supporting language learning named TANGO (Ogata and Yano, 2004; Ogata and Yano, 2005), in which learners can obtain the language express about the object near him with the help of RFID and mobile device; Another is a ubiquitous learning environment for language listening and speaking named HELLO (Liu, 2009), in which learners can access to the English learning resources anytime and anywhere via QR-code and PDA. Both TANGO and HELLO aim at specific language learning objectives, all the learners will get the same learning resources with static contents.

Ubiquitous learning environment with personalized static resources for single objective also aims at specific learning objective, but it can provide learners personalized learning resources with static contents. For example, a ubiquitous learning environment for conducting complex experimental procedures (Hwang, Yang, Tsai, and Yang, 2009), we called CUECE, which can provide suitable operation guidance information to learners via perceiving learners' situation, such as learner's location, and the surrounding situation, such as environmental temperature; another is a ubiquitous learning environment for helping and guiding learning named CAULS (Chen and Huang, 2012), which can use test to understand learner's current learning situation, then choose the appropriate learning strategies and provide corresponding learning resources for learner. In both CUECE and CAULS, in different situations (such as learners' situation, environmental situation, etc.) learners will obtain different learning resources in their learning processes, but learners' final learning objectives are the same. That is, the learning objective supported by learning environment is the same. And although different learners get different learning resources, the contents of all learning resources are also still fixed.

Ubiquitous learning environment with personalized static resources for multiple learning objectives can support different learning objectives and provide personalized learning resources with fixed contents. For example, a ubiquitous learning environment named PERKAM (El-Bishouty, Ogata and Yano, 2006; El-Bishouty, Ogata and Yan, 2007) can recommend suitable and personalized learning resources and helpers around learner according to learner's location, surrounding and his learning objective. Although PERKAM can provide personalized learning resources for learners with different learning objectives, but the contents of the learning resources are still static. That means the contents of a learning resource are fixed, cannot be adjusted dynamically according to different learning objectives, so it is still unable to fully meet the needs of learners with different learning objectives.

3. Context-aware Dynamical Learning Environment for Multiple Learning Objectives

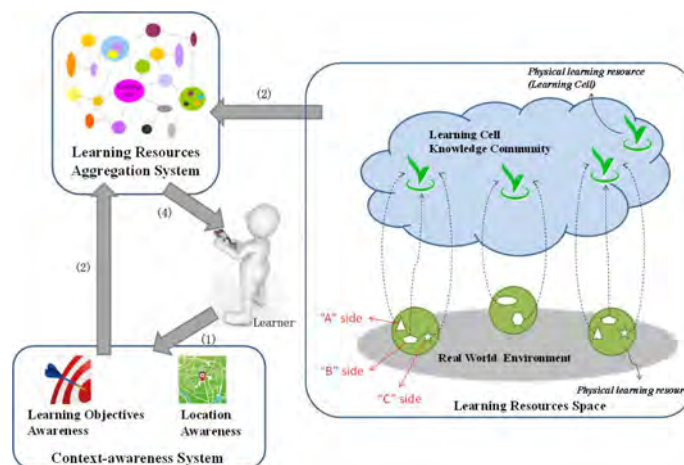

Figure 1. The Context-aware Dynamical Learning Environment for Multiple Objectives

CDLEMO proposed in this study is composed by learning resources space, context-aware system and learning resources aggregation system. CDLEMO is developed by JAVA, using GPS technology to get location information, achieving learning objectives based on location information, using AJAX technology to present learning objectives set and contents, using MySQL5.0 databases to store data.

In Figure 1, learner uses a mobile phone with GPS as his learning device. When the context-aware system obtains learner's location and learning objective, it will deliver the information to the learning resources aggregation system. Then the learning resources aggregation system will find the suitable physical learning resources around learner and the corresponding digital learning resources. A digital learning resource may contain several contents about different sides of a physical learning resource (such as "A" side, "B" side, "C" side in Figure 1), and the contents will be adjusted dynamically and presented to learner according to his learning objective.

3.1 Learning Resource Space

In Figure 1, the learning resource space contains real world environment and digital learning resource space. There are kinds of physical learning resources in the real world environment, such as a tree, a flower. And Learning Cell Knowledge Community (<http://lcell.bnu.edu.cn>) is used as the digital learning resource space in CDLEMO, which can supply various digital learning resources, called Learning Cell(Yu, Yang and Cheng, 2009), short for LC. LC is a novel learning resource model, which can be presented on different learning devices in different formats according to the parameters of learning device. And the contents of LC also can be organized dynamically according to learner's current situation. According to learner's learning objective, when a learner selects a LC for learning, the learning contents in the LC will be adjusted adaptively based on learner's learning objective.

3.2 Context-awareness System

The context-awareness system mainly obtains learner's location information and learning objective. It uses GPS technology to gain learner's location information. The importance of location information is to help the system gain available resources around learner, and get the learning objectives set finally. Once learner connect his phone to wireless networks and open GPS, the system will obtain his location information via GPS. Based on the location information, the system can get all surrounding available physical learning resources as well as the associated digital learning contents. Because of the digital learning contents have their own tags of different learning objectives, the system can aggregate all these learning objectives supported by the learning contents, then presents the learning objectives set to learner, and learner can choose his own learning objective.

3.3 Learning Resource Aggregation System

According to the location information and learner's learning objective, the system will aggregate the surrounding physical learning resources and corresponding LCs, and then present them to learner. For example, there are some dicotyledons and monocotyledons in a garden, and a learner's learning objective is to learn the structure features of monocotyledons, then the system will automatically aggregate and present the pictures of monocotyledons in the garden to learner in order to help him recognize the monocotyledons. And when the learner chooses and clicks a monocotyledon picture on the phone, the system will aggregate the contents about the structure of the monocotyledon of the corresponding LCs dynamically.

4. A Pilot Study

A pilot experiment was conducted in the botanical garden in Beijing Normal University for understanding learner's acceptance and recognition of CDLEMO. After the experiment, an interview was carried on to all participants.

4.1 Participants and experimental procedure

There are six Beijing normal university students participated in the experiment. The researcher randomly divided them into three groups, each group of two people. The experiment was conducted three rounds with three learning tasks in total. Each round, the researcher assigned three tasks to the three groups respectively, and the tasks of the three groups are different. The learning tasks are: observing monocotyledonous leaf and learn leaf characteristics, observing monocotyledonous flower and learn flower characteristics, observing dicotyledonous flower and learn flower characteristics. Every participant used their own mobile devices to do the tasks. The mobile devices include android phone, apple phone and android pad, all of which have GPS.

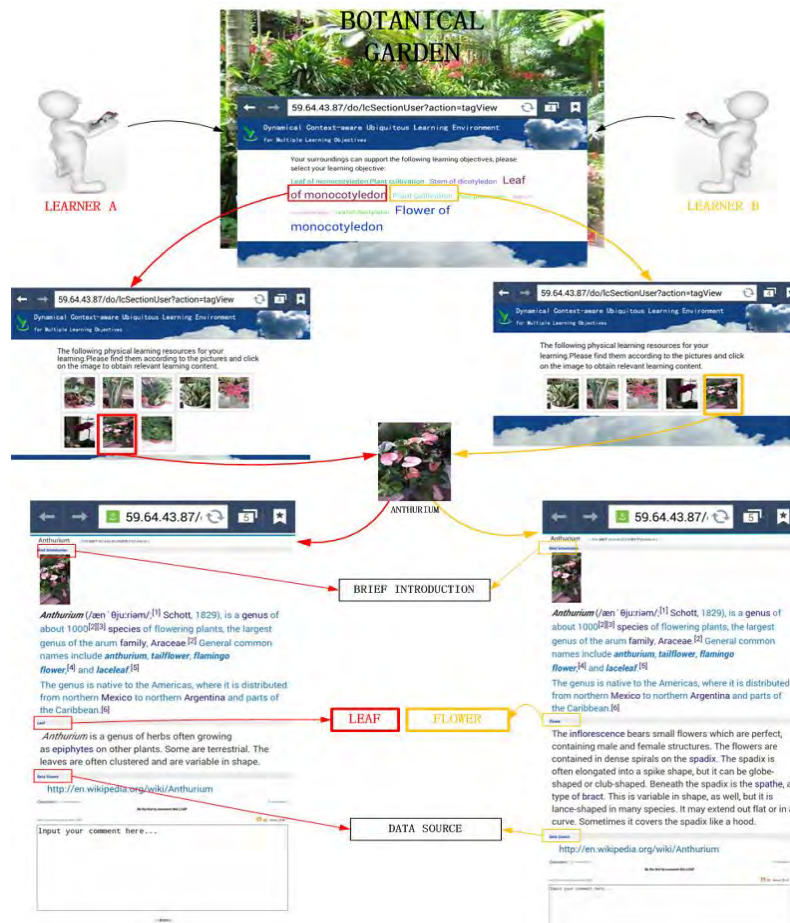

Figure 2. An example of learning in CDLEMO

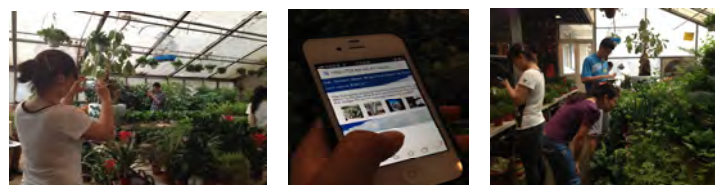

Figure 3. The learning scenarios in CDLEMO

As shown in Figure 2, take a round of experiment for example. After two learners (Learner A and Learner B) come from different groups enter the botanical garden with their mobile phones, the system will get their location via GPS. And then based on the location information, the system will know and present all learning objectives the garden can support to learners. Learner A chooses "monocotyledonous leaves" as his learning objective, learners B chooses "monocotyledonous flower" as his learning objective. Then the system will provide learner A the learning resources supporting learning "monocotyledonous leaves" in the garden, and provide learner B the learning resources supporting learning "monocotyledonous flower". Then the related physical learning

resources' photos taken in the garden will be presented respectively on their mobile phones. When both learner A and learner B choose anthurium as learning object, they will find anthurium in the garden according to the photo on their phones. Then they can observe the anthurium, and click its photo on the phones to access the LC. But when they access the same LC about anthurium, the contents presented on their phones are something different. The contents on Learner A's phone are comprised with three parts: brief introduction, leaf and data source, while the contents on Learner B's phone are comprised with three parts: brief introduction, flower and data source. Figure 3 shows the learning scenarios in the CDLEMO.

4.2 Interview instrument

After the experiment, the researchers conducted an interview for all participants. The purpose of the interview is to understand the learners' acceptability and recognition of CDLEMO, and also collect suggestions for improvement of CDLEMO. S1, S2, S3, S4, S5, S6 were used to represent for the six participants in turn. The interview includes five questions: "Do you think it is convenient for studying in the CDLEMO and why?" "Do you think the learning resources and content provided by CDLEMO are closely related to your learning objective?" "Do you think CDLEMO is helpful to your study and why?" "Would you like to study in the CDLEMO?" "Do you have any suggestions on the improvement of CDLEMO?"

4.3 Findings

After the interview, the data were collected and analyzed. Through the result of interview, we found that:

CDLEMO gains high reorganization from participants. Participants believe CDLEMO has great help in learning. CDLEMO provides learners physical learning resources in the real situation and LCs related to their learning objectives, makes learning become more intuitive and profound, and photos of physical resources help learners quickly find their learning objects within certain scope.

"CDLEMO has great help in learning, let learners watch the objects in the real situation, makes the study more specific, and would not be so abstract." (S1, 2014.05.24)

"Learning is fun and active in real environment." (S2, 2014.05.24)

"The way of finding physical learning resources deepen learner's impression of the learning object." (S3, 2014.05.24)

Participants have high acceptance of CDLEMO. All participants think Learning is very convenient and interesting in CDLEMO, which can quickly provide learning resources according to their learning objectives, and the pictures make learners easily find the unknown physical learning resources.

"CDLEMO is convenient. It can quickly locate and provide related learning resources in this environment." (S1, 2014.05.24)

"CDLEMO is very convenient. It is particularly easy to find physical learning resources via pictures CDLEMO provided." (S2, 2014.05.24)

In addition, participants gave some suggestions for CDLEMO. For example, providing different angle pictures to help learner find resources more quickly, providing a collaborative learning mechanism so that learner can get help from others.

"Presenting several photos taken from different angles for each physical learning resource can make learner find physical resources more convenient and faster." (S1, 2014.05.24)

"Designing a collaboration mechanism that learner can get others' help when he cannot find the physical learning resource." (S4, 2014.05.24)

5. Conclusions and future work

In a real world, different learners have different learning objectives. However, most of ubiquitous learning environments were designed for some specific learning objectives, and supply fixed learning resources with static contents. So that learners with different learning objectives are hard to get the

needed resources. To address this problem, this research proposes CDLEMO. Learners having different learning objectives can study in CDLEMO at same time, and CDLEMO will give them different learning resources related to their learning objectives. CDLEMO gets location information via GPS, and then gains learning objectives based on location information. When it knows learner's learning objective, it will search available and suitable physical resources according to the learning objective, and adjusts learning contents of the digital learning resource for matching learner's learning objective. A pilot experiment was conducted and the result showed that learners' acceptance and recognition of CDLEMO is high. Learners can gain needed learning resources and content quickly in CDLEMO. And they thought CDLEMO made learning become more intuitive, impressive, convenient and fun. Also, some participants put forward some suggestions for improvement of CDLEMO, such as providing more pictures taken from different angles for each physical resource.

Certainly, because of the number of participants is too small, so we need to check the result carefully. And our important future work is to design and do broader sample experiment to verify the effect of CDLEMO in learning, as well as to improve CDLEMO based on learners' suggestions.

Acknowledgements

The authors would like to thank Hai-Peng Wan for his assistance in developing the ubiquitous learning environment. This study is supported by the Joint Laboratory for Mobile Learning, Ministry of Education- China Mobile Communications Corporation.

References

- Ley, D. (2007). Ubiquitous computing. *Emerging Technologies for Learning*, (2), 64-79.
- Chu, H.-C., Hwang, G.-J., Huang, S.-X., & Wu, T.-T. (2008). A knowledge engineering approach to developing e-libraries for mobile learning. *Electronic Library*, 26(2), 303-317.
- Hwang, G.-J., Wu, C.-H., Tseng, J. C. R., & Huang, I. (2011). Development of a ubiquitous learning platform based on a real-time help-seeking mechanism. *British Journal of Educational Technology*, 42(6), 992-1002.
- Shih, J.-L., Chu, H.-C., Hwang, G.-J., & Kinshuk (2011). An investigation of attitudes of students and teachers about participating in a context-aware. *British Journal of Educational Technology*, 42(3), 373-394.
- Hwang, G.-J., Yang, T.-C., Tsai, C.-C., & Yang, S. J. H. (2009). A context-aware ubiquitous learning environment for conducting complex science experiments. *Computers and Education*, 53 (2), 402-413.
- Hwang, G.-J., Tsai, C.-C., & Yang, S. J. H. (2008). Criteria, strategies and research issues of context-aware ubiquitous learning. *Educational Technology and Society*, 11 (2), 81-91.
- Liu, T.-Y. (2009). A context-aware ubiquitous learning environment for language listening and speaking. *Journal of Computer Assisted Learning*, 25(6), 515-527.
- Ogata, H., & Yano, Y. (2004). Context-aware support for computer-supported ubiquitous learning. *Proceedings of IEEE international workshop on wireless and mobile technologies in education* (pp. 27-34). Washington, DC: IEEE Computer Society.
- El-Bishouty, M. M., Ogata, H., & Yano, Y. (2007). PERKAM: personalized knowledge awareness map for computer supported ubiquitous learning. *Educational Technology and Society*, 10 (3), 122-134.
- El-Bishouty, M. M., Ogata, H., & Yano, Y. (2006). Learner-space knowledge awareness map in computer supported ubiquitous learning. *Proceeding of the fourth IEEE International Workshop on Wireless, Mobile and Ubiquitous Technology in Education* (pp. 116-120), Athens, Greece.
- Chen, C.-C., & Huang, T.-C. (2012). Learning in a u-museum developing a context-aware ubiquitous learning environment. *Computers and Education*, 59(3), 873-883.
- Feeney, L., Ahgre, B., & Westerlund, A. (2001). Spontaneous networking: An application-oriented approach to ad hoc networking. *IEEE Communication Magazine*, 39(6), 176-181.
- Kindberg, T., & Fox, A. (2002). System software for ubiquitous computing. *IEEE Pervasive Computing*, 1(1), 70-81.
- Ogata H., Akamatsu R., & Yano Y. (2005). TANGO: computer supported vocabulary learning with RFID tags. *Journal of Japanese Society for Information and Systems in Education*, 22(1), 30-35.
- Yu, S.-Q., Yang, X.-M., & Cheng, G. (2009). Learning resource designing and sharing in ubiquitous learning environment—the concept and architecture of leaning cell. *Open Education Research*, 15(1), 47-53.
- Yu, S.-Q., & Chen, M. (2009). The Characteristics and the trend of ubiquitous learning resources construction—exemplified by the "Learning Cell Resource Model". *Modern Distance Education Research*, 114(6), 14-22.

A Pilot Study Comparing Secondary School Students' Perception of Smart Classrooms in Hong Kong and Beijing

Bao Ping LI^{a*}, Siu Cheung KONG^b

^a*Faculty of Education, Beijing Normal University, Beijing, China*

^b*Department of Mathematics and Information Technology, The Hong Kong Institute of Education, Hong Kong, China*

libp@bnu.edu.cn^a; sckong@ied.edu.hk^b

Abstract: This pilot study compared the difference in secondary school students' perception of smart classrooms between Beijing and Hong Kong using the Smart Classroom Scale (SCS). The study found that students in Beijing had more advanced requirement in physical construction of smart classrooms, while students in Hong Kong had higher expectation on pedagogical activities and deep technology usage in smart classrooms to their counterparts in Beijing. There were significant differences in scales of physical design, learning experience, flexibility, learning data, differentiation, investigation, and cooperation in the SCS. These differences were related to the investment on information technology infrastructure, and pedagogical conception of learning and teaching in smart classrooms which guide the design of learning and teaching activities. The results indicated that the students' perception to smart learning environment was affected by both educational technology investment and classroom pedagogical culture backgrounds. Both Beijing and Hong Kong students had the lowest score in learning data scale, this indicated that the smart use of learning data for pedagogical purpose was not yet thoroughly understood by secondary school students in smart classrooms.

Keywords: learning environment, smart classroom, smart classroom scale, students' perception

1. Introduction

Many researches like Lizzion, Wilson and Simons (2002) supported the view that learning environments could influence students' learning outcome and learning performance, so students' perceptions of learning environment had been studied by many researches. Trickett and Moos (1973) described the classroom environment through three dimensions as system maintenance and change, personal development, and relationship. With information technology integrated into the classroom, digital classrooms have obviously changed in above two dimensions, namely system maintenance and change, and personal development. Some new instruments like Technology-rich Outcomes-focused Learning Environment Inventory (TROFLEI) (Aldridge, Dorman, and Fraser, 2004), Technology Integrated Classroom Inventory (TICI) (Wu, Chang, Guo, 2009) for assessing students' and teachers' perceptions of digital classrooms have been developed. The instruments focused on computer usage and digital learning activities like individual learning, and inquiry learning in the classrooms.

With the introduction of richer and more diversified types of information technology in classrooms, this type of classroom is classified as smart classroom. Smart classrooms support students' learning in virtual and physical learning environments; support students' hands-on learning experiences; extend students' learning experiences outside classrooms; and give students adaptive learning help through massive learner data analysis. (Li zhang, Marco Gillies, Kulwant Dhaliwal, and et al, 2009; Minchi C. Kim, Michael J. Hannafin, 2011). Therefore, this type of classroom is considered to be conducive to cultivating students' learning skills which are needed in the 21st century. Many countries and regions have designed and constructed the cyber schools and smart classrooms to cope with the trend of e-learning development in the 21st century.

Beijing and Hong Kong are two renowned international cities. In recent years, a considerable number of primary and secondary schools in Beijing were invested with a substantial amount of budget for building cyber schools and constructing smart classrooms. Numerous teachers had accepted systematic development to change their traditional pedagogical conception such as changing the

teacher-centered pattern to student-centered paradigm. Hong Kong is one of the financial centers in the world, the primary and secondary students in the city have more cross-cultural background in their daily life. Hong Kong also has a long-term influence from UK in its education system, educational culture, and learning and teaching approach. The diversity of educational investment in Hong Kong did make a difference between the investment in building cyber schools and constructing smart classrooms between Beijing and Hong Kong.

Welch, Cakir, Peterson & Ray (2012) make cross-cultural validation of the TROFLEI in both Turkey and the USA in order to allow the comparison of classroom environments across these two cultures. They stated that comparison of educational practices, beliefs and attitudes of two countries provides deep insights into their relative positions. As there are a number of significant differences between the education systems in Beijing and Hong Kong as well as their cultural background, this pilot study is interested in the comparison of students' perception of smart classrooms in the two cities. The pilot study aims to investigate whether the differences in investment, the learning and teaching approach, as well as the cultural background are also reflected in students' perception of smart classroom. The results of the pilot study will be helpful for us to control the external factors which influence students' perception of the smart classroom environment. Li, Kong and Chen (2014) revised the details of the classroom environment of the three dimensions proposed by Trickett and Moos (1973) and developed and verified the Smart Classroom Scale (SCS) based on the current features of technology-rich classrooms. Therefore, this pilot study conducted the survey for students' perception of smart classrooms between a secondary school in Beijing and a secondary school in Hong Kong using SCS.

2. Method and Procedure

2.1 Instrument

The SCS was derived from a number of existing digital classroom instruments. They are TROFLEI, TICI, and Computerized Classroom Ergonomic Inventory (CCEI). SCS was validated as a reliable instrument by involving more than 300 students in primary and secondary schools in Shenzhen and more than 200 students in Beijing to answer to the scale. Finally ten scales and 39 items are included in the SCS which focus on the physical appearance, learning and teaching activities, and ecology of smart classroom (Li, Kong and Chen, 2014). The details of the SCS are summarized in table 1.

Table 1: A detailed description of the Smart Classroom Scale with sample of item in each scale.

Scale	Description	Sample of Item
Physical Design (PD)	The extent to which the spatial area, furniture equipment, and information technology infrastructure of smart classrooms.	I have adequate workspace for putting textbooks, tablet PCs and other resources.
Flexibility (FLE)	The extent to which the flexible support for users by classroom environment.	The classroom can be a theater, a group working place or other scenes for different learning purposes.
Technology Usage (TU)	The extent to which learners use information technology as a tool to learn and to access information.	I deal with my assignments using computer or other digital devices.
Learning Data (LD)	The extent to which the information technology was used to acquire and analyze the learning data of the users.	I can find out my learning history, like my homework, and discussions in the last semester.
Differentiation (DIF)	The extent to which teachers cater for learners differently on the basis of ability, rates of learning and interests.	I can learn at my own pace.
Investigation (INV)	The extent to which skills and processes of inquiry and their use in problem solving and investigation are emphasized.	I carry out investigations to test my ideas.

Cooperation (CO)	The extent to which learners cooperate with one another on learning tasks.	I can cooperate with somebody through internet when doing assignment work.
Learner Cohesiveness (LC)	The extent to which learners know, help and are supportive of one another.	I always help other students in the class.
Equity (EQU)	The extent to which learners are treated equally by the teacher.	The teacher gives as much attention to my questions as to other learners' questions.
Learning Experience (LE)	The extent to which learners' satisfaction and some special learning experience in smart classrooms.	The devices and software help me to get hands-on experience with the learning objects or learning context.

2.2 Sample

A secondary school which was an e-Learning Pilot School in Hong Kong and a secondary school which had solid information technology infrastructure in Beijing were selected for this pilot study. Seventy-one students with age from 13 to 15 years old in the secondary school in Hong Kong, and 76 students with age from 13 to 15 years old in the secondary school in Beijing were invited to respond to the SCS. Table 2 shows the demographic data of the students in these schools. All students in these two schools had experiences of conducting e-learning inside and outside the technology-rich classrooms.

Table 2: The demographic feature of students in the two secondary schools.

School	Age			Gender	
	13	14	15	Female	Male
Beijing	44	30	2	36	40
Hong Kong	17	46	8	36	35

2.3 Procedure

With the consensus of the school administrators, a questionnaire survey was distributed to the targeted students for collecting perceptions of students in the two cities. The questionnaire contained a cover sheet about the details of the participants such as age and gender, and the questionnaire. The questionnaire contains all the questions of the SCS. It asked students about their perception to the learning environment of smart classrooms. All questions asked students in a positive scoring direction and the 5-point Likert-type scale with anchors from almost never (scored as 1) to almost always (scored as 5) were used in the SCS. The students were provided with sufficient time to respond to the questions in the SCS.

2.4 Data Analysis

Data were analyzed using descriptive statistics including exploratory factor analyses, Independent-Samples T-test, and Cohen's d. The descriptive statistics such as means, standard deviations and Cronbach's alpha coefficient (as an index of internal consistency reliability) for each of the 10 scales of SCS were also calculated.

3. Results

Internal reliability was tested using the individual student as a unit of analysis for the Cronbach's alpha coefficient. The overall Cronbach's alpha coefficient is 0.93. A principal components analysis with varimax with Kaiser Normalization rotation yielded 10 scales for the existing form of SCS with total variance explained 69.31%. The Cronbach's alpha values and the exploratory factor loading results of the 10 scales of the SCS were shown in table 3.

Table 3: Cronbach's alpha values and exploratory factor loading results of the SCS.

Scale	Cronbach's alpha	Factor Loading				
		Item1	Item2	Item3	Item4	Item5
PD	0.69	0.73	0.68	0.74	0.63	
FLE	0.26	0.74	0.55	0.87		
TU	0.83	0.83	0.81	0.77	0.77	
LD	0.68	0.79	0.83	0.78	0.64	
DIF	0.87	0.74	0.85	0.80	0.82	
INV	0.86	0.80	0.70	0.67	0.79	0.65
CO	0.86	0.78	0.57	0.62	0.75	
LC	0.84	0.74	0.80	0.78	0.79	
EQU	0.84	0.78	0.90	0.83	0.75	
LE	0.80	0.75	0.80	0.82		

The Mean, Standard Deviation (SD), T-test, and Cohen's d in both schools in Beijing and Hong Kong were shown in table 4. Cohen's d is an effect size used to indicate the standardized difference between two means.

Both Beijing and Hong Kong students had the highest score (4.07 for BJ and 4.00 for HK) in Learner Cohesiveness (LC) and lowest score (2.23 for BJ and 3.04 for HK) in Learning Data (LD). In Beijing, the scales of Flexibility (FLE), Learning Data (LD), Differentiation (DIF), Innovation (INV), and Cooperation (CO) were lower than average level 3.00. In Hong Kong all the 10 scales were higher than 3.00. Except the two scales for relationship as Learner Cohesiveness (LC) and Equity (EQU), all other eight scales had significant differences in students' perception between the two secondary schools in Beijing and Hong Kong.

Table 4: The mean, SD, T-test and Cohen's d of the SCS of schools from Beijing and Hong Kong.

Trickett and Moos Schema	Scale Name	No. of Items	Mean		SD		T-test	Cohen's d
			BJ	HK	BJ	HK		
System maintenance and change	PD	4	3.52	3.37	3.86	3.43	-2.04*	0.04
	FLE	3	2.52	3.44	2.90	4.41	3.50**	-0.24
	TU	4	3.65	3.71	3.65	3.11	10.52***	-0.02
	LD	4	2.23	3.04	3.54	3.89	4.86***	-0.22
Personal development	DIF	4	2.37	3.31	4.75	3.26	6.69***	-0.23
	INV	5	2.82	3.55	4.56	2.89	4.90***	-0.19
	CO	4	2.70	3.54	5.58	3.65	4.82***	-0.18
Relationship	LC	4	4.07	4.00	3.79	3.04	-1.86	0.02
	EQU	4	3.80	3.66	5.09	2.90	-1.32	0.03
	LE	3	3.61	3.62	3.79	2.40	2.54*	0.01

Notes: * $p < .05$; ** $p < .01$; *** $p < .001$

4. Discussion

Based on Trickett and Moos schema, secondary school students' perception of smart classrooms between Beijing and Hong Kong had significant difference in both system maintenance and change, and personal development. As shown in figure 1, students' perception of Physical Design (PD) and Learning Experience (LE) in Beijing school are higher than those in Hong Kong. The study attributes these to the large amount of information technology infrastructure investments in primary and secondary schools in China during the past decade. Early in 2000, China carried out a series of projects in primary and secondary schools for digital schools construction in the mainland, such as connecting internet into every school. Beijing is the capital of China; there were a substantial amount of financial inputs to the construction of infrastructure in schools every year. Many schools in Beijing have equipped with tablet PCs, interactive desks, and large surface interactive screens, which enable it to precede in smart schools pilot programs in China.

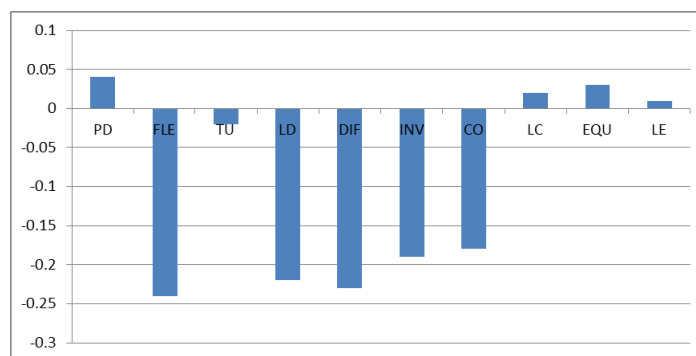

Figure 1. Cohen's d of two schools in Beijing and Hong Kong.

Primary and secondary schools in Hong Kong put more effort to develop pedagogy adopting constructivist's approach than their counterparts in Beijing, and class activities in schools in Hong Kong tend to put more effort in the student-centered approach in learning and teaching practices. For example, the selected school in Hong Kong is taking part in the pilot scheme on e-learning in schools. It uses the ICT to improve teaching and learning qualities, and to develop the learner-centered learning mode. In their learning process, it focus on inspiring students' creativity, cultivating students learn to analyze, learn to cooperate and learn to integrate ICT in their problems solving. With this regard, students in Hong Kong are more familiar with individualized, constructive, and collaborative learning. Therefore, perceptions of students in Hong Kong were much higher in the scale of differentiation (DIF), investigation (INV), and cooperation (CO) scales.

As all students involved in the survey are all having the learning experience in the technology-rich classroom, so the scores of Hong Kong students were a little bit higher than those of Beijing students in Technology Usage (TU) scale. Scores of Flexibility (FLE) and Learning Data (LD) in Hong Kong were much higher than those in Beijing; the study attributes these to the differences in the culture of using technology for more learner-centered learning for schools in Hong Kong.

Students in Beijing and Hong Kong are both influenced by traditional culture of Chinese like solidarity and friendliness, therefore both Beijing and Hong Kong students' perception to Learner Cohesiveness (LC) and Equity (EQU) had no statistical significant differences.

The differences in students' perception of each scale in smart classroom give ample evidence for the issue that the investment for ICT infrastructure in school, the teaching and learning approach in classroom, and pedagogical culture of the city do have some correlation with students' perception of learning environments.

Besides the differences, the study also found some similarities between the two secondary schools in Beijing and Hong Kong. The highest three scales in both schools are LC, EQU, and TU, the lowest scale in both schools is LD. The results indicated that in the technology-rich classroom the ICT technology do not change the traditional student-student and student-teacher relationship too much, but it give students more opportunities to use the devices and subject matter tools in learning. So in this survey both students in two different cities have highest perception of the three scales. Well, smart classroom is the higher level of digital classroom (Huang, et al, 2012), some new features, like learner analysis, are emerged. The students need time to adapt to the innovation learning style which based on the massive learning data analysis. So both students got the lowest score in the scale.

Conclusion

This pilot study conducted a survey to students of a secondary school in Beijing and a secondary school in Hong Kong using the SCS for studying students' perception of smart classrooms. The study found that students in Beijing had more advanced requirement in physical construction of smart classrooms, while students in Hong Kong had higher expectation on pedagogical activities and deep technology usage in smart classrooms to their counterparts in Beijing. Li and Kong (2014) indicated that smartness of learner data is one of important smartness towards smart classrooms, the survey found both schools' students have lower perception of Learning Data (LD) scale, this indicated

that the smart use of learning data for pedagogical purpose were not yet thoroughly understood by secondary school students in smart classrooms in both cities. The result gave ample evidence for the conclusion that the students' perception of learning environments were effected by financial investment, pedagogical culture, teaching and learning approach in schools, and their own culture background. The conclusion inferred that physical equipment is the basic element for smart classrooms, and students have the most intuitive perception of its change and its usage in classrooms. But the change of the students' perception of the constructive learning activities, learning data based learning support are relative indirect. The innovation of smart teaching and learning activities, and cultivation the technology enhanced learner-centered pedagogical culture in schools are the bridge to improving the students' perceptions of the smart learning environment, as well as the students' learning outcomes.

The secondary school in Beijing should pay more attentions on how to improve students' participation and interaction in their classroom through its advanced information technology infrastructure for e-learning to improve students' perception of the learning activities in the whole smart learning environments. Both secondary schools in Beijing and Hong Kong should develop more teaching and learning modes based on massive learner data to guide the students' deep understanding for the importance of learner data in smart learning environments.

References

- Lizzion, Wilson, Simons. (2002). University Students' Perceptions of the Learning Environment and Academic Outcomes: implications for theory and practice. *Studies in Higher Education*. 27, 27-51.
- Trickett, E. J., & Moos, R. H. (1973). Social environment of junior high and high school classrooms. *Journal of Educational Psychology*, 65(1), 93-102.
- Aldridge, J. M., Dorman, J.P., Fraser, B.J. (2004). Use of Multitrait-Multimethod Modelling to Validate Actual and Preferred Forms of the Technology-Rich Outcomes-Focused Learning Environment Inventory (TrofleI). *Australian Journal of Educational & Developmental Psychology*. 4, 110-125.
- Wu, Chang, Guo. (2009). The Development of an Instrument for a Technology-integrated Science Learning Environment. *International Journal of Science & Mathematics Education*.7, 207-233.
- Anita G. Welch , Mustafa Cakir , Claudette M. Peterson & Chris M. Ray (2012) A cross-cultural validation of the Technology-Rich Outcomes-Focused Learning Environment Inventory (TROFLEI) in Turkey and the USA. *Research in Science & Technological Education*. 30:1, 49-63, DOI: 10.1080/02635143.2012.659179.
- Li zhang, Marco Gillies, Kulwant Dhaliwal, Amanda Gower, Dale Robertson, Barry Crabtree.(2009). E-Drama: Facilitating Online Role-play using an AI Actor and Emotionally Expressive Characters. *International Journal of Artificial Intelligence in Education*.19, 5-38.
- Minchi C. Kim, Michael J. Hannafin.(2011). Scaffolding problem solving in technology-enhanced learning environments (TELEs): Bridging research and theory with practice. *Computers & Education*. 56 , 403-417
- Li, B.P., Kong, S.C., & Chen, G. (2014 July). A Study on the Development of the Smart Classroom Scale. In *Proceedings of the International Conference on Smart Learning Environments Conference* (pp. 39-40). Hong Kong: Springer's Lecture Notes in Educational Technology Series.
- Huang ronghuai,Hu yongbin,Yang junfeng.(2012) The Function of smart classroom in smart learning age. *Open Education Research*.18(2), 22-27.In Chinese.

A Study of Student Behavior in Classroom Response Systems

Kozo MIZUTANI^{a*}

^a*Department of Human Information Systems, Faculty of Science and Engineering, Teikyo University, Japan*

*mizutani@ucl.teikyo-u.ac.jp

Abstract: The Classroom Response System (CRS) is a useful tool for enhancing interactivity between teachers and students in the classroom. Through its use of smart devices and PCs, CRS is expected to be effective at aiding both classroom interaction and learning. However, these devices can be used for more than CRS; they may also serve as entertainment tools. This study investigates the behavior of students who use CRS on such devices. Specifically, it analyzes log data of student behavior, focusing on student responses and their behavior of switching application programs on CRS. The results of analysis show a trend that students who immediately switch applications after answering a question on CRS have a low correct answer rate.

Keywords: Classroom Response System, Clicker, Smart Devices, Student Behavior

1. Introduction

The Classroom Response System (CRS) is a well-known tool for enhancing interactivity between teachers and students in the classroom. In recent years, many studies have used Clicker. Because Clicker makes the communication between students and teachers more interactive in the classroom, its use in pedagogy has spread recently in various fields of education. (Crews, T. B. et al., 2011; Raes, A., et al., 2013; Kulesza A. E. et al., 2014; Han, J. H. et al., 2013). However, Clicker cannot improve the interaction between a teacher and an individual student due to its system architecture, as described below.

- Clicker has only one-way messaging from a student terminal to a teacher PC on the system.
- Generally, students' wireless terminals are composed only of buttons.
 - ✓ The message is only the information that the student has clicked the button. The student cannot send a teacher a message or question.
 - ✓ The teacher cannot provide teaching materials that include text, images, sounds, and video, to an individual student. In addition, teacher cannot send a message to an individual student.

To resolve these problems, researchers have developed CRSs that use various devices such as cell phones, smart phones, tablets, and PCs, as the student terminals. For example, Robbins, S. (2011) used ClassQue, a PC application, in courses on MATLAB programming, Java programming, computer organization, and operating systems. ClassQue has several unique functions such as seating charts, review messages, and comment sharing in a group. Especially in recent years, the number of studies using smart devices (e.g., cell phones, smart phones, tablets) has been increasing. Andergassen, M. et al. (2012, 2013) developed browser-based mobile clickers called Learn@WU. Nielsen et al. (2012) presented their project that is developing a Student Response System (SRS) co-funded by the European Commission. Dunn, P. K. et al. (2012) implemented a low-cost, mobile-phone-based CRS named VotApedia. They evaluated the system by collecting data specifically related to interacting with the user interface, the in-class delivery, and instructor perceptions of student engagement. The author of this paper is also developing a web-based CRS that has the functions for real-time interactions using HTML 5 and WebSocket that are new technologies for the Web (Mizutani, K., 2013).

On the other hand, smart devices can run not only CRS but other software applications as well, and thus, they can serve various functions, such as providing entertainment. The GSM Association's

(2013) international survey on children's use of mobile phones revealed that most children access the internet and download applications, and entertainment is the most popular among the child users.

For this reason, the devices used in classrooms often have limitations on which software programs or device functions can be accessed. Yet because smart devices offer useful software for learning, it is not an easy task to decide the policies of such limitations. Not only the limitations of the devices but the functions of CRS and its practical implementation must be considered to improve student understanding.

In this paper, as the first step toward finding behavior patterns that represent the relations between students' understanding and their using events on CRS, investigates the relations between the events of student responses and user behavior events, namely, window switching of applications on PCs. It is thought that the correct answer rates of students who lack sufficient understanding will be lower than those of students who understand well. One hypothesis is that the number of times these students switch windows will be relatively high because they will switch to a web browser to search for answers to the questions. Also, if the students are not interested in listening to the teacher's lecture, they might answer the questions randomly or without putting much thought into their choices, then switch quickly to entertainment contents on their smart device.

If there is indeed a relationship between students' responses and their behavior of window switching, the findings may be used to identify students who are in need of learning support. Therefore, this paper seeks to identify these relationships by using the originally developed CRS.

2. Methods

2.1 *Developing a Real-time Classroom Response System, "Response Analyst"*

For the purpose of this study, an original CRS called "Response Analyst" was developed because the existing systems, including CRS products, have the following problems.

- The interaction on CRS is not in real-time.
 - ✓ Every student behavior on the CRS has to be in real-time and logged with precision. Otherwise, the data on the students' behavior will be inaccurate.
- The existing systems lack functions for providing teaching materials to each student.
 - ✓ Student terminals often consist of only buttons; they cannot display the teaching materials.
 - ✓ Even if the student terminal has a screen, it often shows only text, not multi-media content.
- The existing systems cannot monitor the events of switching windows on a PC.
 - ✓ This is an important function for this study. Student behavior events such as receiving teaching material, starting thinking, answering, switching windows, etc. have to be recorded.

To implement these functions, Response Analyst has been developed as an application for PCs instead of smart devices. It might have been developed as a software program for smart devices such as smart phones or tablets, but it is difficult to monitor the events of student behaviors, especially switching windows (or applications), on the security models of the smart devices. Therefore, this study hypothesizes that student behavior does not differ between PCs and smart devices.

Response Analyst has a Server-Client model architecture. Its server program communicates to the teachers' client program and the students' client program. To realize real-time processing, the communication has been defined as original protocols.

Figure 1 shows examples of the user interfaces of the teachers' client program (A) and students' client program (B). When students click the answer button, their response is immediately reported to the teachers' program. The teacher can check each student's answers or view a graph that summarizes all the students' answers on the external screen, such as a projector (Figure 1, A-2).

2.2 *The basic sequence of Response Analyst and the design for logging student behaviors.*

Figure 2 shows the basic sequence of each of the programs of Response Analyst. The messages between Teachers' Program and Students' Program are communicated keeping TCP/IP connections for real-time processing, because establishing the connections of each messaging worsens the system's real-time

processing. However, for precisely logging the events of student behaviors, the delay of the TCP/IP communications should be considered. Also, the time stamp of the events might differ by device because a device's clock may not be correct.

This study focuses on student behaviors on the student devices. Of particular importance is the behavior of the students between receiving a question and answering it on their student devices. Therefore, Response Analyst logs the events on both the server and each student device. As shown in Figure 2, the client program logs section data, which are a set of the events between the user receiving a question and answering it. When the student program is closed, the section data are sent to the server in a lump.

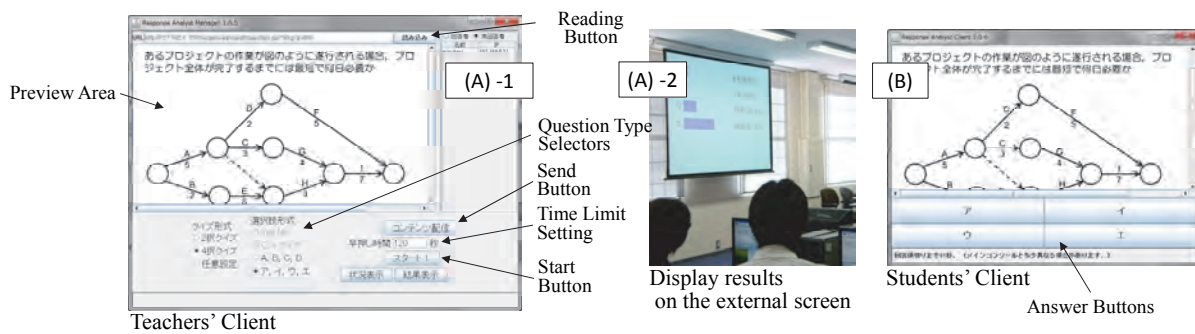

Figure 1. Example screenshots of Response Analyst.

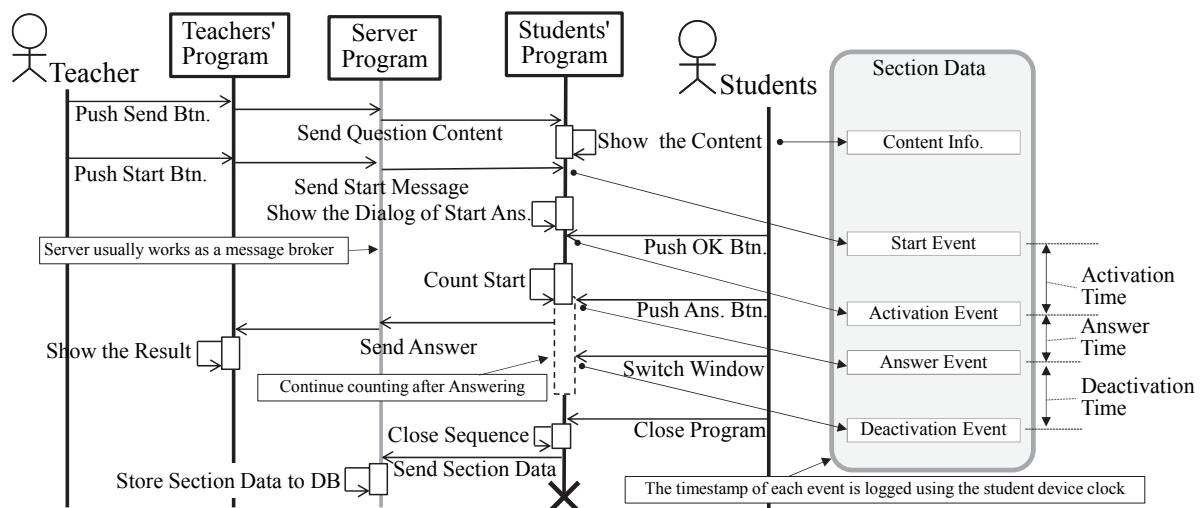

Figure 2. The basic sequence of Response Analyst and the abstract of event logging.

2.3 Log analysis

The section data include the timestamp that is based on incorrect clock on the student device. To reduce the inaccuracy of the timestamp, the section data are analyzed using the time that is the span of one event from the event of receiving the message to start answering. Specifically, as the preprocessing of the log analysis, the time span data is calculated as follows and as shown in Figure 2.

- Answer Time: The time between the start of answering and the user's click on the answer button
- Activation Time: The time between the start of answering and the activation of the window of the student client
- Deactivation Time: The time between user's click on the answer button and the deactivation of the window of the student client

Moreover, because the limit time for each question is different, the time span data are normalized by using the limit time of each question.

To determine the relations between these events, the time span data are analyzed as follows.

- The difference of the answer events between correct and incorrect answers
 - ✓ First, to roughly gauge the trend of the difference in correct and incorrect answers, the mean values of the Activation Time and Deactivation Time are compared by a t-test.
- Making clusters of the students' behavior
 - ✓ To reveal the differences in student behavior, after the average values of Correct Rate, Answer Time, Activation Time, and Deactivation Time are calculated for each student, K-means Clustering is applied to the average values.

3. Results

3.1 Practical use of Response Analyst

Response Analyst was used in a class designed for students to learn the basis of knowledge of information technology. The course syllabus includes solving the past versions of the Information Technology Passport Examination (IT Passport Exam), one of the Information Technology Engineers Examinations in Japan. The IT Passport Exam consists of multiple-choice questions. Examinees select one answer from among four choices in response to each question.

In the class, students were given questions from past issues of the IT Passport Exam by Response Analyst. The teacher explained the issues to the students while referring to the results of the answers in Response Analyst. When sending questions, the teacher set the limit time for a question based on their own judgment. A total of 1,863 section data were logged in the class. This included the logs of 53 students who attended the class, 50 questions from past versions of the IT Passport Exam, and activation/deactivation events.

3.2 Analysis Results

3.2.1 The difference of the answer events between correct and incorrect answers

Table 1 shows the results of a t-test comparing the correct and incorrect answers, answer time, activation time, and deactivation time. These results exclude the section data in which the deactivate time is over 1, because this shows that the student changed the window after the time limit was over. Of course, the data received after the limit time are also important. However, because the purpose of this study is to identify behavior patterns in the course of using Response Analyst, the events that fall within the limit time are more important than those occurring after it. The results of the logarithmic transformation of the activation time and deactivation time were used in a t-test, because the distribution of activation time and deactivation time seems normal.

In each of the results, if the value of the f-test is > 0.05 , the value of the t-test shows the results of the t-test assuming equal variances (Student's t-test). If the value of the f-test is < 0.05 , the value of the t-test shows the results of the t-test assuming unequal variances (Welch's t-test).

3.3 Making clusters of the students' behavior

K-means Clustering that is a cluster analysis method in which the value of K is the number of the clusters. Before the K-means Clustering, the data of the students who had given only a few answers were excluded. The average number of times a student answered is 25.00 times. The maximum and minimum are 51 times and 1 time, respectively. Because the standard deviation is 13.74, the minimum threshold is defined as 11.26. Eleven students' data that are less than the threshold were excluded from the target of K-means Clustering.

In this study, the optimal K value was calculated using the reconstruction error that is the sum of the mean squared error between all data in the cluster and the centroid of the cluster, in each K value (Alpaydin, E. 2004). As the result of the reconstruction error, it is assumed the optimal value of K is 4 or 5. Then, Table 2 shows the detailed results for each cluster with K values 4 and 5. The clusters are ordered by their average correct answer rate.

Table 1: Results of a t-test about the difference between correct and incorrect answers.

		Mean	Median	SD	f-Test (P , two-tail)	t-Test (P , two-tail)
Answering Time	Correct	0.423	0.390	0.245	0.385	0.364
	Incorrect	0.403	0.375	0.249		
Activation Time	Correct	0.117	0.064	0.132	0.027*	0.407*
	Incorrect	0.133	0.076	0.157		
Deactivation time	Correct	0.133	0.057	0.163	0.769*	0.006*
	Incorrect	0.106	0.046	0.147		

*The results using the values by logarithmic transformation.

Table 2: The clustering results and mean values for each student.

k	Cluster No.	Count	Average Correct Rate	Average Time		
				Answer	Activation	Deactivation
4	1	12	0.412	0.519	0.148	0.580
	2	11	0.419	0.442	0.167	0.290
	3	6	0.523	0.572	0.127	0.930
	4	13	0.716	0.507	0.115	0.757
5	1	16	0.364	0.459	0.149	0.399
	2	5	0.528	0.562	0.116	0.964
	3	11	0.559	0.536	0.130	0.725
	4	6	0.682	0.498	0.158	0.470
	5	4	0.823	0.515	0.133	0.890

4. Consideration

Table 1 shows the results of the t-test for the difference of the average of correct and incorrect answers. In regard to answering time, the mean value between correct and incorrect answers is not significantly different at the significance level of 5% because the t-test result is 0.364. Similarly, for activation time, there is no significant difference because the t-test result is 0.407. On other hand, the t-test result of deactivation time is 0.006, showing that the mean values of deactivation time are significantly difference between correct answers and incorrect answers. The mean value of the incorrect answer of deactivation time is 0.106, which is smaller than the mean value of the correct answer. The results point to a trend in which the answer is incorrect when the behavior of switching program windows after answering occurs earlier.

Similarly, a trend is also revealed by the results of the K-means Clustering, as shown in Table 2. A comparison of the smallest and largest clusters in terms of the average of correct rate in each k value shows that the deactivation time of the smallest cluster is shorter than that of the largest cluster. For example, when k is 5, the deactivation time of the smallest cluster in the correct rate (No. 1) is 0.399, and for the largest cluster (No. 5), it is 0.890. To validate the difference of these two clusters, a t-test about the deactivation time data was tried. The result was $P < 0.000$, it showed a significant difference at the significance level of 5%.

These results point to the following:

- Because the mean values of deactivation time are significantly different between correct and incorrect answers, when the deactivation time of answering behavior is smaller, the answer might be incorrect.
- The students with low correct answer rates immediately switch program windows after answering questions on CRS, in contrast to the students with high correct answer rates. When a student's deactivation time is short, his or her correct answer rate might be low.
- Predicting incorrect answers based on answer time and activation time is difficult. This study identified the significant differences between these times and students' answer behaviors.
- It may be possible to use deactivation time as a means of identifying students who need help from the teacher. To realize this, CRS on smart devices should have a function for catching the event of switching applications. However, the necessity of this function has not generally been discussed so far.

This finding presents the possibility to realize a learning support function that automatically detects the state of a student. For example, it is able to realize a function that detects a student who is low correct rate and switch quickly to other window after answering on CRS, calls the student attention and notices the detection to a teacher. The author of this paper also plan to implement the automatic learning support function to the original CRS of oneself and to evaluate the instructional effects.

5. Conclusions

The purpose of this study is to investigate the behavior of students who use CRS on smart devices. This paper describes the results of an analysis of log data on student behavior, focusing on student responses and the behavior of switching applications on CRS.

An original CRS “Response Analyst” was used in a class aimed at teaching the basis of knowledge of information technology. The log data were analyzed using the statistical methods of t-test and K-means Clustering. The results revealed a trend that the correct answer rate of students who immediately changed applications after answering questions on CRS was low. However, this trend was not found out from the time of answering the questions to the time of activation events, that is, switching application windows. The results of the K-means Clustering showed a relationship between students who have a low correct answer rate and short deactivation time after answering. This finding presents the possibility that CRS can identify students who may need help from the teacher.

Acknowledgement

The system is supported by JSPS KAKENHI Grant Number 24700911.

References

- Alpaydin, E. (2004). Introduction to Machine Learning. Cambridge, MA: MIT Press.
- Andergassen, M., Guerra, V., Ledermüller, K., & Neumann, G. (2012). Browser-based mobile clickers: Implementation and challenges. In *Proceedings IADIS International Conference–Mobile Learning*.
- Andergassen, M., Guerra, V., Ledermüller, K., & Neumann, G. (2013). Development of a browser-based mobile audience response system for large classrooms. *International Journal of Mobile and Blended Learning (IJMBL)*, 5(1), 58-76.
- Crews, T. B., Ducate, L., Rathel, J. M., Heid, K., Bishoff, S. T. (2011). Clickers in the classroom: Transforming students into active learners. *EDUCAUSE Center for Analysis and Research (ECAR), Research Bulletins*.
- Dunn, P. K., Richardson, A., McDonald, C., & Oprescu, F. (2012). Instructor perceptions of using a mobile-phone-based free classroom response system in first-year statistics undergraduate courses. *International Journal of Mathematical Education in Science and Technology*, 43(8), 1041-1056.
- GSM Association (2013). Children’s use of mobile phones 2012: An International Comparison.
- Han, J. H., & Finkelstein, A. (2013). Understanding the effects of professors’ pedagogical development with Clicker assessment and feedback technologies and the impact on students’ engagement and learning in higher education. *Computers & Education*, 65, 64-76.
- Kulesza A. E., Clawson M. E., & Ridgway, J. S. (2014). Student success indicators associated with clicker-administered quizzes in an honors introductory biology course. *Journal of College Science Teaching*, 43(4), 73-79.
- Mizutani, K. (2013). Development of Response Analyzer Systems improving scalability and real-time processing. *Proceedings of the 38th Annual Conference of Japanese Society for Information and Systems in Education*. TE2-3, 323-324.
- Nielsen, K. L., Stav, J. B., Hansen-Nygård, G., & Thorseth, T. M. (2012). Designing and developing a student response system for mobile internet devices. *Learning with Mobile Technologies, Handheld Devices, and Smart Phones: Innovative Methods*, 56.
- Raes, A., Vanderhoven, E., & Schellens, T. (2013). Increasing anonymity in peer assessment by using classroom response technology within face-to-face higher education. *9th International Conference on Computer Supported Collaborative Learning*, 2, 922-923.
- Robbins, S. (2011). Beyond clickers: Using ClassQue for multidimensional electronic classroom interaction. In *Proceedings of the 42nd ACM Technical Symposium on Computer Science Education* (pp. 661-666). ACM.

An Approach to Electronic Textbook Linking Chemical Experiment - Esterification of Acetic Acid and Ethanol -

Akira IKUO*, Yusuke YOSHINAGA, & Haruo OGAWA
Department of Chemistry, Tokyo Gakugei University, Japan
*ikuo@u-gakugei.ac.jp

Abstract: A computer graphics (CG) teaching material of the esterification of acetic acid and ethyl alcohol was made based on quantum chemical calculations. The teaching material could simultaneously display realistic shapes and electrostatic potentials of the intermediates of the reactants on the way of the reaction profile besides the ball-and-stick model of the intermediates. The material was tried to combine with chemical experiments of student's laboratory of the university for the purpose of making electronic textbook.

Keywords: CG, visualization, chemical reaction, electronic textbook, tablet computer.

1. Introduction

Understanding the observed phenomena, chemists use to imagine and explain observations in terms of molecules (Figure 1). Observed phenomena and molecular level models are then represented in terms of mathematics and chemical equation (Gilbert, 2009 and Tasker, 2010).

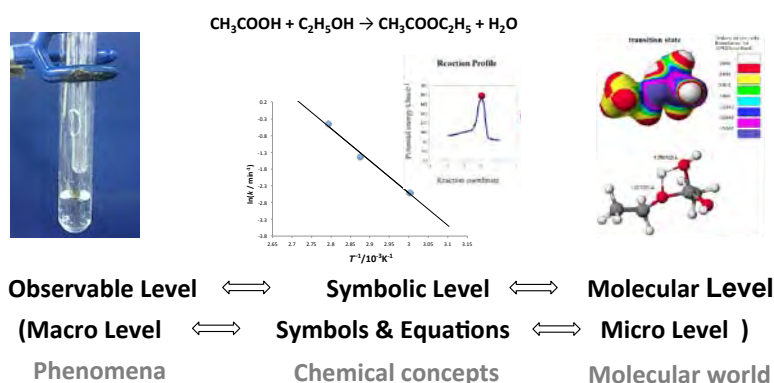

Figure 1 Dividing the image into the three thinking levels

Student's difficulties and misconceptions in chemistry are from inadequate or inaccurate models at the molecular level (Kleinman, 1987). A molecular structure visualized by the computer graphics (CG) provides a deeper understanding of molecular structure (Tuví-Arad, 2006). It is our aim to produce a CG teaching material based on quantum chemical calculations, which provides realizable images of the nature of chemical reaction (Ikuo, 2006 and 2009). Molecular level animations combined with video clips of macroscopic phenomena enabled students to predict the outcome better (Velazquez-Marcano, 2004). If the CG teaching material is combined with chemical experiments of student's laboratory, students would observe the reaction from three thinking levels, namely, phenomena in the actual observable level and CG teaching material in the molecular level, and chemical equation in the symbolic level. The CG teaching material on the tablet computer was effective to provide image of "Energy" change and also effective to provide image of "Structure"

change and “Migration of Electron” during chemical reaction (Ikuo, 2012). Our ultimate goal is to produce an electronic textbook linking chemical experiment, which integrates these three levels.

Chemical reaction is generally expressed by a chemical formula that provides information of the reaction about its stoichiometry; however, chemical formula does not provide information about its realistic shape and reactivity of molecule. This information is essential to realize images of chemical reaction. Molecular models such as wire, ball-and-stick, and space filling, are popularly used to realize images of molecule. They are used properly for the purpose of providing information of molecule about bond length and its angle, shape, and so on. Generally, the electron density iso-surface on CG is displayed with realistic shape of molecule, and electrostatic potential on CG provides information about electrical character of a certain part of molecule.

In this paper, we report here a CG teaching material adopting the CG with electrostatic potential on electron density that represents both realistic shape and electrostatic potential of molecule for the purpose of making electronic textbook for university student laboratory, which integrates the observable level experiment and the molecular world of the esterification.

2. Procedure

2.1 Quantum Chemistry Calculation

Esterification of acetic acid and ethyl alcohol is described as shown in the equation (1).



The mechanism of the reaction is well known (For example Loudon, 1984), and generally, the esterification proceeds in the presence of proton catalyst. The rate-determining step includes the paths of an attack of the oxygen atom of hydroxyl group of ethyl alcohol to the central carbon of the formed carbonium ion and release of water as shown in the Scheme 1. This step dominates all over the reaction, and then the calculation based on quantum chemistry on the rate-determining step was carried out. Although another mechanism that involves more than a pair of reactants is possible as reported in the case of carbonic acid formation (Nguyen, 1984), it was not considered in this paper for simplicity of program.

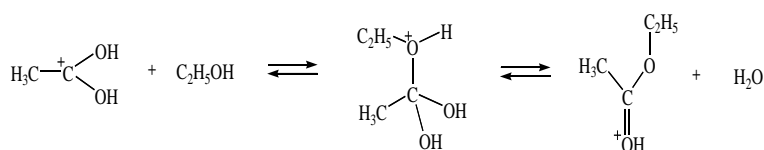

Scheme 1 Mechanism of the esterification on the rate-determining step

Structures of intermediates on the esterification of acetic acid and ethyl alcohol and their electrostatic potentials on electron density were calculated as follows: the semi-empirical molecular orbital calculation software MOPAC (Stewart, 1989) with PM5 Hamiltonian in the CAChe Work System for Windows (Former name of SCIGRESS, ver. 6.01, FUJITSU, Inc.) was used in all of calculations for optimization of geometry by the Eigenvector Following method, for search of transition state by use of the program with Saddle point Search, and for search of the reaction path from the reactants to the products via the transition state by the intrinsic reaction coordinate (IRC) calculation (Fukui, 1970). Details of procedure of the quantum chemical calculations were described in the previous paper (Ikuo et al., 2006). The electrostatic potential on electron density (EPED) (Kahn, 1986) was calculated based on structures from the results of the IRC calculation (Ikuo et al., 2014).

2.2 Production of Teaching material of CG and Electronic Textbook

A movie of the reaction path was produced by the software DIRECTOR (ver. 8.5.1J, Macromedia, Inc.) following the display of the bond order of the structure of the reactants in each reaction stage,

which was drawn by the CAChe. The obtained CG of EPED model was combined with those of ball-and-stick model and reaction profile in the same reaction stage. It was confirmed that the drawn CGs of the molecular models of reactants moves smoothly. The green ball, which indicates progress of the reaction, was arranged on the reaction profile and simultaneous movements of the ball and the reactants were confirmed. Created movie file was converted to the Quick Time movie for iPad by the Quick Time PRO (ver. 7.66, Apple, Inc.). Electric textbook was produced with iBooks Author (ver. 2.1.1, Apple, Inc.) and was saved to iPad (Apple, Inc.) by using the iTunes (ver. 11.2.1, Apple, Inc.).

3. Results and Discussion

3.1 CG Teaching Material

The Quick Time movie file was created as teaching material by use of 100 frames of combination CGs.

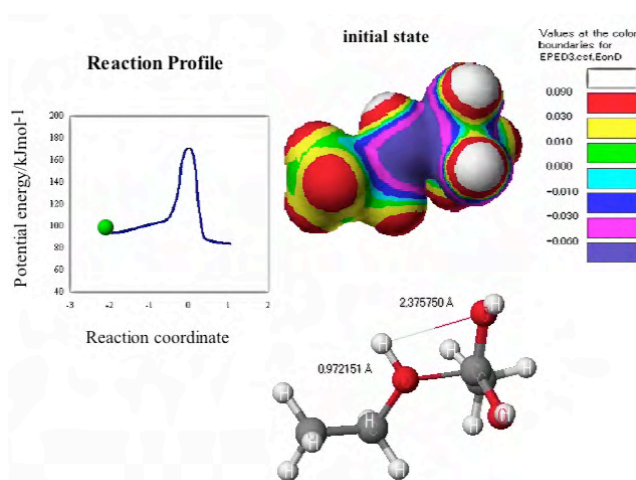

Figure 2 CG teaching material

The Figure 2 shows the combination CGs on the way from the state of reactants to that of products via the transition state. The teaching material demonstrates the changes of electrostatic potential and realistic shape of the intermediate of the reaction on the reaction profile in all stages at the same time.

The values of electrostatic potentials were represented in different colour on the model of intermediate, and figure legend of colour boundaries for electrostatic potential was also listed. Distribution of the electrostatic potential among the intermediate can be seen by the colours. For example, oxygen of ethanol is negatively charged with relative value of -0.06 based on evaluation of energy of interactions of prove proton to the charge of iso-surface, and hydrogen of carbonium ion is positively charged with the relative value of +0.09. The model by electrostatic potential provides information about electrostatic distribution of the intermediate on the way of the reaction.

The green ball on the reaction profile can move by users' choice of the way of automatic movement or manual movement along the reaction coordinate, which indicates the most probable pathway of chemical reaction according to the IRC theory (Fukui, 1970), by use of the Quick Time control bar. Other CGs such as EPED and ball-and stick modes are also synchronized with the movement of the ball so that the degree of the reaction progress and structural change of the molecules of all stages could be demonstrated simultaneously. The CG teaching material provides details of the chemical reaction mechanism dynamically.

3.2 Electronic Textbook

The teaching material was tried to combine with chemical experiments of student's laboratory for the purpose of making electronic textbook of basic chemistry to provide experiment at the

observable-level, CG visualization at the molecular-level, and chemical equation at the symbolic-level.

The electronic textbook was inserted with images of experimental procedure in the flow charts and pictures, which can be enlarged by students touch (Figure 3). CG teaching materials of reaction profiles were also inserted (Figure 4). When student touches the CG teaching material in the tablet computer, the teaching material appears to show image of the structural change during the reaction. When student touches the material again, the Quick Time control bar appears and the green ball on the profile can move by student's choice. Student can manipulate the reaction back and forth until they obtain the image of the reaction.



Figure 3 Experimental procedure from the electronic textbook

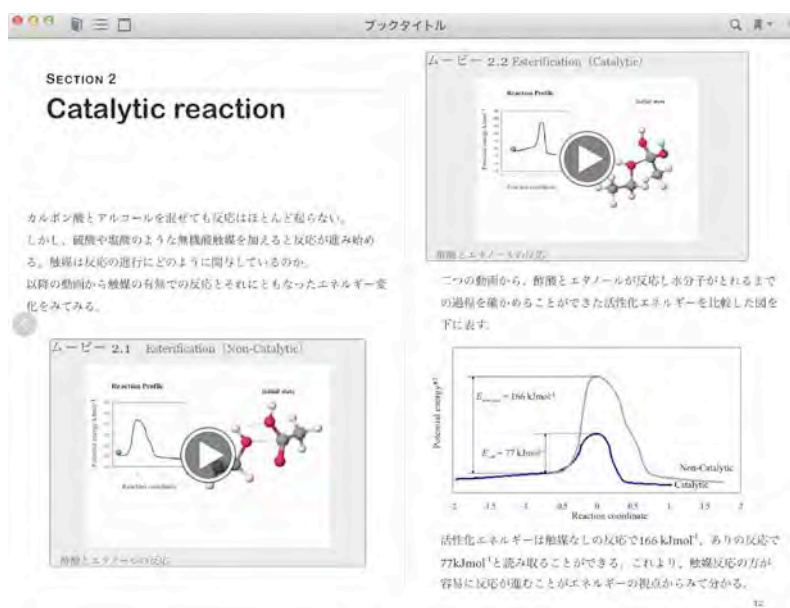

Figure 4 CG teaching material in the electronic textbook

4. Conclusions

A CG teaching material of the esterification of acetic acid and ethyl alcohol was made based on quantum chemical calculations. The teaching material could simultaneously display realistic shapes and electrostatic potentials of the intermediates of the reactants on the way of the reaction profile besides the ball-and-stick model of the intermediates. The material could demonstrate these images of dynamical reaction mechanism for the esterification. The material was tried to combine with chemical experiments of student's laboratory of the university for the purpose of making electronic textbook. The textbook could display picture of apparatus and flow-chart of experiment in addition to the CG teaching material. The electronic textbook could integrate the observable level experiment and the molecular world of the esterification.

Acknowledgements

This work was supported by JSPS Grant-in-Aid for Scientific Research (C) (25350188).

References

- Fukui, K., (1970). A Formulation of the Reaction Coordinate, *J. Phys. Chem.*, 74, 4161-4163.
- Gilbert, J. K. & Treagust, D. F., (2009). in Gilbert, J. K. & Treagust, D. (eds.), "Models and Modeling in Science Education Vol. 4 Multiple Representations in Chemical Education", Springer, 333-350.
- Ikuo, A., Ikarashi, Y., Shishido, T., & Ogawa, H., (2006). User-friendly CG visualization with animation of chemical reaction: esterification of acetic acid and ethyl alcohol and survey of textbooks of high school chemistry, *J. Sci. Educ. Japan*, 30 (4), 210-215.
- Ikuo A., Nagashima H., Yoshinaga Y., & Ogawa H., (2009). Calculation of potential energy in the reaction of "I + H₂ → HI + H", and its visualization, *The Chem. Educ. J. (CEJ)*, Registration #13-2.
- Ikuo, A., Nagashima, H., Yoshinaga, Y., & Ogawa, H., (2012). Development and practice of teaching material in tablet computer based on computer graphics by quantum chemistry calculation - Reaction of I + H₂ → HI + H -, *Proc. 7th IEEE Intl. Conf. on Wireless, Mobile, and Ubiquitous Technologies in Educ.*, 82-86.
- Ikuo, A., Yoshinaga, Y., & Ogawa, H., (2014). CG Teaching Material for the Electronic Laboratory Textbook Esterification of Acetic Acid and Ethanol, *Proc. 6th Intl. Conf. on Computer Supported Educ. (CSEDU 2014)*, 226-231.
- Kahn, S. D., Pau, C. F., Overman, L. E., & Hehre, W. J., (1986). Modeling Chemical Reactivity. 1. Regioselectivity of Diels-Alder Cycloadditions of Electron-Rich Dienes with Electron-Deficient Dienophiles, *J. Am. Chem. Soc.*, 108, 7381-7396.
- Kleinman, R. W., Griffin, H. C., & Kerner, N. K., (1987). *J. Chem. Edu.*, 64, 766-770.
- Loudon, G. M., (1984). *Organic Chemistry*, Addison-Wesley Publishing Co., Inc., p.1010.
- Nguyen, M. T. & Ha, T. K., (1984). A theoretical study of the formation of carbonic acid from the hydration of carbon dioxide: a case of active solvent catalysis, *J. Am. Chem. Soc.*, 106(3), 599-602.
- Stewart, J. J. P., (1989). Optimization of parameters for semi empirical methods I. Method, *J. Comp. Chem.*, 10 (2), 209-220.
- Tasker, R. & Dalton, R., (2010). in Gilbert, J. K., Reiner, M., & Nakhleh, M. (Eds.), "Models and Modelling in Science Education Vol. 3 Visualization: Theory and Practice in Science Education", Springer, 103-131.
- Tuvi-Arad, I. & Blonder, R., (2006). Continuous symmetry and chemistry teachers: learning advanced chemistry content through novel visualization tools, *Chem. Educ. Res. and Pract.*, 11(1), 48-58.
- Velazquez-Marcano, A., Williamson, V. M., Ashkenazi, G., Tasker, R. F., & Williamson, K. C., (2004). The use of video demonstrations and particulate animation in general chemistry, *J. Sci. Educ. and Tech.*, 13(3), 315-323.

An Online Course for Active Participation and Interactive Learning: An Exploratory Study

Qiyun WANG^{a*}, & Wehao LI^b

^aLearning Sciences and Technologies, National Institute of Education, Singapore 637616

^bSchool of Educational Information and Technology, Central China Normal University, China

*Qiyun.wang@nie.edu.sg

Abstract: Learning is a highly social process. However, Asian students are often found quiet and passive in the classroom. How to promote their active participation and interactive learning becomes a challenge. In this study, a course that was previously conducted in the face-to-face classroom was redesigned and conducted online. This paper describes the design of the course from pedagogical, social, and technical aspects, and presents the students' perceptions of the design and implementation. Results show that students became more active and interactive; technical infrastructure played a critical role; and monitoring students' participation and engagement was a new challenge in the course implementation process.

Keywords: Active participation, Interactive learning; Online learning; Pedagogical design; Social design; Technical design

1. Introduction

Asian students are often found quiet and passive in the classroom, and they seldom speak out unless they are called upon by instructors (cf. Thompson & Ku, 2006). How to promote their active participation and interactive learning becomes critical. School teachers in Asian countries often teach in traditional ways where teaching is perceived as disseminating information and learning as a passive activity (Lim, 2007). Simply encouraging student to actively interact with peers and with the teacher but without changing instructional strategies would hardly work (Livinston & Condie, 2006). For more active participation and interactive learning to take place, teachers often need to redesign lessons to involve more student-centered learning activities.

Integrating technology into the teaching and learning process has the potential to promote students' active participation and interactive learning. A technology-enabled learning environment often provides an equal and comfortable space where students are willing to participate and interact (Thompson & Ku, 2006). However, few cases about using technology to support teaching and learning in the context of China have been reported in international journals (Thompson & Ku, 2006). This study was initiated to promote students' active participation and interactive learning by redesigning an existing course, which was previously conducted in the face-to-face classroom, into an online module. This paper describes the design of the course from pedagogical, social, and technical aspects and also presents students' perceptions of the design and implementation of the course.

2. Design

The course entitled *Introduction to Educational technology* was a core module offered to the undergraduate students at a Chinese university. A total of 50 students (12 males and 38 females) were enrolled into the course in that semester. Their average age was about 24. They majored in various subjects such as English language (N=22), Psychology (N=6), or Physical Education (N=4). They had taken a basic computer literacy course and their computer competency levels were equivalent. They would become primary or secondary school teachers after completing a four-year study.

2.1 Pedagogical Design

Before a lesson, learning resources including PowerPoint slides and other learning materials were online available for the students to download and study. The students were required to go through the resources and complete the learning activities embedded in the slides in groups or individually.

During the lesson, all students were required to login to the online course at the fixed time. The purpose of having a real-time lesson was to provide them with opportunities to share and interact with others simultaneously. Individual students or groups were invited to present their understanding in the lesson. During the presentation, other students were reminded to concentrate on and participate in the presentation. They were encouraged to ask questions in written text. After the presentation, the teacher picked up some issues from the presentation to further discuss with the class. The lesson implementation process was recorded and uploaded online for future reference.

After the lesson, students were required to write reflections in their individual weblogs to further think about what they had learned from the lesson and how to apply what they had learned. Every student was encouraged to read and give comments to others' reflections.

2.2 Social Design

The social design of the course aimed at providing a safe and comfortable environment where students would actively participate and interact with peers. The online course was set as a closed space where only approved users were able to access. To a great extent, this would keep the course safe by preventing strangers from accessing it. The teacher decided to use voice communication as well as text chat in the online course after considering the shyness of students and the capacity of voice in conveying emotions (Aragon, 2003). In addition, the teacher played music before a lesson, which served the purpose of creating a comfortable environment and letting the students know that he was online ready.

2.3 Technical Design

The tools selected for hosting the course were YY Voice and QQ Group. YY Voice is a free software program in which virtual classrooms can be created and users can have real-time communication via voice or text. Teachers can broadcast their voice or share the whiteboard with students. The students can talk to the whole class after getting permission from the teachers.

Another free tool - QQ Group - was selected for group members to share resources and discuss ideas. The QQ Group also provides members with personal spaces where they can bookmark useful websites and write diaries. In this course, the personal spaces were used for students to write individual reflections, read others' reflections, and give comments. Both YY Voice and QQ Group could be accessed on any platform (e.g. Windows, Android, or iOS) using any device (laptops, Tablets, Mobile phones).

2.4 Research Question and Instruments

This study aimed to answer the following main research question: How did the students perceive the design and implementation of the online course? More specifically, this research question aimed at identifying the students' perceptions of the pedagogical, social, and technical designs of the online course. A survey consisting of 22 5-point Likert Scale (from 1-strongly disagree to 5-strongly agree) items, which were adapted from the existing survey validated by Wang (2009), was used to collect quantitative data. Forty-seven students responded to the survey with a responding rate of 94%. The survey items were found to be highly reliable ($\alpha=.924$). An open-ended question was included in the survey to collect students' comments and suggestions. Lesson observation notes taken by the teacher were also collected.

3. Findings

3.1 Pedagogical Design

Table 1 shows the respondents' perceptions of the pedagogical, social, and technical designs of the online course. The students were generally satisfied with the pedagogical design of the environment. They liked the way of involving online learning in the course, as they could interact and collaborate with others. In their answers to the open-ended question, they mentioned that they gained knowledge and skills from this course, as participating in this course required them to put a lot of efforts in reading and discussion. They had opportunities to share their understanding, discuss ideas, and clarify doubts with peers. These opportunities enabled them to learn from others and construct knowledge. Also, they could review the instructional process as the recorded lesson was available online.

The students became more active in the implementation process of the course compared to that in the face-to-face classroom. They actively asked the teacher or peers questions or responded to their questions in written text. A student' answer to the open-ended question well explains why she kept active in the course:

I have to be very careful and active in the online class. Online learning is unlike in a classroom where I have neighbors to ask when I miss out something. I won't know what to do next if I do not concentrate or when I drift away.

3.2 Social Design

The students commonly felt that this course offered a comfortable space. They could attend class while resting in the hostel with a cup of tea. They could ask questions and get prompt feedback from the teacher and peers without interrupting them. However, certain students indicated that participating in online learning at the hostel lacked a learning climate. Their roommates might be walking around, eating, or watching movies on their computers, which caused much distraction to their learning. The students were more confident in asking questions and/or giving answers in the online course. They were less worried about losing face since the others could not see them. Nevertheless, they felt they were socially connected with others. To a great extent, communication via text and voice in the online course enabled them to establish social presence. A student responded that:

It is a little bit pity that I never saw the teacher and classmates. I may not be able to recognize them when I see them. But it does not matter. I still remember them as I am familiar with their voices and tones. E.g. the funniest voice is from a PE male student, and the sweetest soprano voice is from a girl of the Music College.

Lesson observation notes showed that students' online discussion frequently lagged behind the pace of an oral presentation. Occasionally, students were still discussing about the content on the previous slide after the presenter had moved to the next slide. This observation suggests that the teacher as a facilitator should closely monitor the discussion progress and give student sufficient time to reflect and type in their thoughts. In addition, it was a challenge for the teacher to monitor every student's participation and engagement as some of them kept quiet or did not take part in the discussion.

3.3 Technical Design

The students could conveniently access the online course without technical difficulties. Also, they could view the teacher's shared whiteboard and annotations. A student shared in her response that:

When I first knew I was enrolled into an online course, I was very upset as my friends told me that taking an online course requires high technical skills but I am not technology savvy. After installing the YY Voice, I found it was not hard to use. ... I realized that an online classroom was not that scaring but quite interesting.

However, some students encountered certain technical problems. A common problem was that the Internet access speed was slow and unstable sometimes. As a result, they could not watch the shared whiteboard or the video played by the teacher.

4. Discussion

This study showed that the students were active and the learning process was interactive. A few reasons might contribute to this result. Instructional (re)design played a vital role. Many student-centered learning activities were involved in the course. The activities included studying and discussing on learning materials before a lesson, having students' presentations during the lesson, and writing reflections after the lesson. This finding supports the notion that it is a combination of many instructional design endeavors rather than simply putting a course online that contributes to the often-reported positive outcomes of online learning (Means, Toyama, Murphy, Bakia, & Jone, 2010).

Also, students had the tendency to behave more actively in an online environment. Physically being there and listening to the teacher's instruction are typical behaviors of students in a classroom (Thompson & Ku, 2006). In a virtual learning environment where the teacher cannot see them, however, students often have to participate actively to indicate their social presence.

Social presence is heavily affected by social interactions rather than the intrinsic attributes of the media used (Garrison, et al, 2000). The result of this study confirmed that using voice enabled social presence to be easily established, as voice can easily reflect the emotions and friendliness of the speaker (Aragon, 2030).

In addition, text chat also played a vital role in promoting social presence and social interactions in this online course. Text chat provided a backchannel for students to interact with others while they were attending a presentation. This backchannel could ". . . [change] the dynamics of the lecture room from a one to many transmission to a many to many interaction, without disrupting the main channel communication" (Ross et al., 2011, p. 215). However, the teacher should closely monitor the content and progress of backchannel discussion to make the discussion more effective.

The success of using technology for teaching and learning depends on the implementation support in the education system (Fullan & Donnelly, 2013). The result of this study indicated that the technical infrastructure in the university needed to be further improved. The low networking speed negatively affected the students' perception of the course implementation. This finding confirms that technical design provides conditions for effective pedagogical and social designs to take place. Without sufficient technical design and support, theoretically sound pedagogical or social design will not function well (Wang, 2008)

In addition, other supporting facilities such as the classroom or library also needed to be renovated. Online learning usually enables learning to take place anytime anywhere. However, almost all students took part in the online course at the hostel in this study. The campus was not fully covered with a wireless network and the library did not allow them to talk loudly. In this case, staying at the hostel was nearly the only choice left. To make online learning more flexible and effective, the university should provide more venues like small rooms in the library for students to engage in online learning.

This study did not examine the students' actual learning outcomes. Even though the students responded that they learned more knowledge and skills from this course, no concrete results showed that the students could perform better. Future research can investigate students' learning outcomes after taking the online course. In addition, video has become a ubiquitous means of communication that it has been labeled the 'new text' (Prensky, 2012). Future studies will incorporate video conferencing to investigate its feasibility and effect on learning.

References

- Aragon, S. R. (2003). Creating social presence in online environments. *New Directions for Adult and Continuing Education*, (100), 57-68.
- Fullan, M., & Donnelly, K. (2013). *Alive in the swamp: Assessing digital innovations in education*. London: Nesta.
- Garrison, D. R., Anderson, T., & Archer, W. (2000). Critical inquiry in a text-based environment: Computer conferencing in higher education. *The Internet and Higher Education*, 2(2-3), 87-105.

- Lim, C.P. (2007). Building teachers' capacity for using technologies in schools: A case-study of in-service professional development in Barbados. *Educational Media International*, 44(2), 113-128.
- Means, B., Toyama, Y., Murphy, R., Bakia, M., Jones, K. (2010). Evaluation of evidence-based practices in online learning: A meta-analysis and review of online learning. Center for Technology in Learning, U.S. Department of Education. Retrieved May 10, 2010 from <http://www.ed.gov/about/offices/list/opepd/ppss/reports.html>.
- Prensky, M. (2012). New Issues, New Answers: Teaching the Right Stuff: Not Yesterday's Stuff - But Tomorrow's. *Educational Technology*, 52(3), 64.
- Ross, C., Terras, M., Warcik, C., & Welsh, A. (2011). Enabled backchannel: conference Twitter use by digital humanists, *Journal of Documentation*, 67(2), 214-37.
- Thompson, L., & Ku, H. (2006). Chinese graduate students' experiences and attitudes towards online learning, *Educational Media International*, 42(1), 33-47.
- Wang, Q.Y (2008). A generic model for guiding the integration of ICT into teaching and learning. *Innovations in Education and Teaching International*, 45 (3), 411-419.
- Wang, Q.Y. (2009). Designing a web-based constructivist learning environment. *Interactive Learning Environments*, 17(1), 1-12.

Checkpoints for Integration of a One-to-One Tablet Configuration in a School Learning Environment

Johannes ZYLKA^{a*}, Wolfgang MUELLER^b

^a*Alemannen Community School Wutöschingen, Germany*

German Institute for International Educational Research (DIPF), Germany

^b*Media Education and Visualization Group (MeVis), University of Education Weingarten, Germany*

*zylka@dipf.de

Abstract: The hereby given article focuses on challenges and potentials of the integration of a one-to-one tablet computer environment in schools. On the basis of advantages and disadvantages of the use of tablet computers in learning scenarios and especially in classroom use, actual approaches to implementation of one-to-one tablet configurations in formal education system will be discussed in a practice-driven way by exemplarily starting from the point of given technological, organizational, personal and educational preconditions from a southern German Community School. These will be generalized and thus lead to a comprehensive view on the integration of one-to-one tablet computer configurations in given complex settings of institutions in formal education system. This article will therefore result in general and system-independent conclusions and recommendations practicable for school institutions, which are presented in terms of Checkpoints for One-to-One Tablet Integration in Schools.

Keywords: Tablet Computers, iPads, Learning Environment, Schools, ICT Infrastructure.

1. Introduction

Tablet Computers are supposed to bring one of the groundbreaking changes to learning inside and outside classrooms (cf. Johnson et al., 2013; and McLester, 2012;), even though their integration in school systems is far from natural or unproblematic (Armstrong, 2014). Since the 2010 introduction of the iPad, tablet computers grew immensely in importance, in private life as well as in professional settings (Griffley, 2012, p.8), which is for instance shown by the school tablet project map of Germany (Ludwig, 2014). Speaking of the field of education, approaches related to the use of tablet computers are mostly project-oriented, offering students a device for testing purposes but not for long-term use (cf., e.g., Hahn and Bussell, 2012, p.43).

Actually it can be stated that there are two main directions of research going into the use of tablet computers in formal education system: On the one hand side, the devices are being offered by institutions representing the educational system, such as schools or media centers. This can be the case in terms of tablet devices being used in a specific subject or project for some time, where students are using the technology just in classroom. The initial point for this procedure regularly is to be seen in the strong financial limitation of most educational institutions leading to a missing capability to comprehensively introduce one single device for all of the students, as well as in the comparatively low effort that has been invested before using the devices. Unfortunately, the additional benefit is also strongly limited because of missing continuity and missing opportunity for the students to get in contact with the devices in every day grid.

To overcome these issues, on the other hand side, there is another approach being discussed called BYOD (Bring-Your-Own-Device), which is partially seen as forward-looking approach because private available and already existing devices are being integrated in learning scenarios. Advantages are obvious: Since students are allowed to use their own technical devices, schools are not confronted with large costs for the purchase of these and, furthermore, students are responsible for the maintenance of the devices. The most important disadvantage of this approach is the integration of a variety of different

devices and different operating systems. This is not only challenging on a technical layer, but also from a pedagogical point of view, since educators have to check whether a specific app is available for Apple iOS, Google Android and Microsoft Windows Mobile. Furthermore, not every student might be equipped with a respective device, what strengthens the well-known digital divide (e.g., Ritzhaupt, Feng, Dawson, and Barron, 2013).

This article will further discuss a third possibility, a combination of these two approaches in terms of an one-to-one tablet computer equipment, which is supposed to combine strong advantages and minimize disadvantages that have been named above.

2. Learning with Tablet Computers

Mobile devices in general and Apple iPads in specific have been proposed for a while now as an enhancement for classical school and class setting. Corresponding approaches may be classified into one-to-many and one-to-one configurations (Hahn and Bussell, 2012, pp.46; Pamuk et al., 2013; Miller, 2012, pp.54). In one-to-many settings, specific classes or projects are equipped with such devices. Also, class-sets may be made available for lending for use in specific subject fields. In one-to-one settings, on the other hand, schools or other institutions either target to equip each student with an individual device, possibly also for private use, or they allow for the use of privately owned devices in school. The latter approach is typically denoted as Bring-your-own-technology (BYOT) or Bring-your-own-device (BYOD) (Lee and Levins, 2012).

Different forms of this will be shortly presented in the following, which will be followed by the description of the specific situation at a southern German school, the Alemannen Community School Wutöschingen (ASW).

2.1 One-to-One Tablet Computer configurations

While most experiences from the use of mobile devices in schools originate from one-to-many settings and pilots (for instance, Culén and Gasparini, 2011), corresponding studies and experiences in the one-to-one-field are less prevalent. The Portuguese Magellan initiative represents an example for the state-wide introduction of mobile technology in schools on a one-to-one basis. In this initiative, primary school children were provided with a low-cost laptop between 2008 and 2009. While this project received much recognition in the public, the results were less satisfying: The Magellan laptops were little used by teachers and students, on the one hand because of the lack of access to wireless Internet in schools, on the other hand apparently due to a lack of appropriate teacher training (Carvalho, 2011). These experiences highlight the imperative of appropriate infrastructure and teacher support when trying to implement a one-to-one strategy.

Foote (2012) describes a district's approach in the direction of establishing a one-to-one iPad program and first positive results from a pilot. For instance, 88% of the students reported an enhancement of learning experience, and 90% stated a somewhat positive or positive effect on their motivation to learn. Foote also highlights the value of supporting activities, such as the installation of a help-desk and voluntary after-school meetings. The Steve Jobs Schools in the Netherlands represent a recent case for the implementation of a one-to-one configuration with iPads at elementary school level (O4NT, 2014). The O4NT approach without doubts can be seen as exemplary, since here the focus is on a new pedagogy, leading to a novel curriculum, where iPads play a crucial role. However, evaluations of this approach are still missing.

BYOT or BYOD initiatives at school level are more rare, and reports on the implementation of such programs even more. McPhail and Paredes (2011) report from some pilots in this area, the development of a corresponding district's policy, and directions to successfully implement a BYOD approach.

2.2 Situation at ASW

Tablet-related situation at schools often is that students are just punctually equipped with the devices in terms of specific lessons or short-term projects. They thus are regularly confronted with a short usage time of the devices and extensive potentials of these aren't used, because they are not understood as personal learning environment (PLE). At ASW, school and commune found a way to cooperatively offer students the proposal to lease a tablet computer (in this case, an Apple iPad Air). Students are allowed to use the devices for private life, leading towards a personal device, which is also used for

learning purposes. For the leasing itself, a public advertisement was offered and the computer leasing company offering the best proposal was chosen. For the specific understanding of the next steps of tablet integration at ASW, a short excursus on the school system at ASW itself is of relevance.

2.2.1 Excursus on ASW School System

Over the past five years, school system in the German federal state Baden-Württemberg changed immensely. While the classic German educational school system mostly differentiates three school forms (low track, middle track and high track), some schools in Baden-Württemberg chose to move beyond this manifested external differentiation and integrated all tracks in one school, implying huge requirements related to individual learning and advancement. At ASW, this new system was integrated for fifth graders four years ago and was continued the following years. For now, students of the fifth grade, sixth grade as well as seventh grade (and from September 2014 on also 8th grade) are learning in this self-directed way. In total, about 450 students are visiting the ASW.

2.2.2 Technical Requirements

Before the students are equipped with and actually can use the devices in their daily grid in school, the school has to make different technical as well as pedagogical arrangements. In a first step, the availability of an adequate internet connection has to be named, which is capable of offering an enduring and stable internet connection via wireless networks. An adequate internet connection with good data transmission as well as router devices with the respective capacity are necessary (Armstrong, 2014, p.45). At ASW, we use a 120 mbits/s connection in combination with an Apple MacMini Server is caching the internet data to improve the connection. Additionally, web access monitoring is necessary.

Besides these aspects related to the internet connection, the maintenance of the devices is another aspect of particular importance. Not only related to the procedure in case of problems or technical failures, but also related to installed apps, updates and general software settings. The respective school has to decide what aspects it can come across by own employees (mostly teachers) and which aspects should be outsourced. Accordingly, system administrators have to think of effort neutral ways to keep the systems up-to-date, what points towards installed apps and software settings. One interesting and helpful endpoint management software package which is being used at ASW for the management of Apple products is the Casper Suite offered by JAMF Software.

Although the above described technical requirements are themselves extensive in preparation and lots of additional work where ICT-experts are needed, the real challenge is not to offer the technological framing of learning processes, but to amend the given school system in a reasonable way.

2.2.3 Pedagogical Requirements

Anyway, to achieve this added value, a pedagogical concept, which names concrete procedures how to come across the technical possibilities and problematic issues besides the technical aspects, has to be developed. It has to begin at the school-specific situation, including teachers, involving different existing committees (with students, parents and teachers), to consider the peculiarities of different departments, taking into account technical infrastructure and furthermore. The situation often differs a lot, because schools in German federal state Baden-Württemberg are often missing in a media development concept, leading to technology being irregularly used, not finding its way into every-day use at schools.

At this point, a concept has to be developed, connecting the given resources and technological surroundings to the capacity of teachers as well as students. While professional training programs especially for teachers are (independent of the teachers' age) necessary and have to support teachers in integrating new technology in their working schemata, students regularly need introductory courses to be aware of critical aspects of the devices. Ideally, students would use their own tablet device without extensive software-based restrictions, but are self-consistently aware of the use of their device. Limiting the access of internet (in school or at home) or specific apps are said to possibly lead to a reduction of interest in using the devices (Pamuk et al., 2013, p.1819).

3. Educational Concept at ASW related to tablet computers

As we are speaking of the ICT-related training of students: Every ICT-affine teachers knows that there are always some kids around, which are good in using ICT. Sometimes, they are even better than the respective teachers. While some teachers see this as challenge of their authority, the relation between

student and teacher should be understood as educational partnership, where both can learn from each other. So why not taking some ICT-competent learning partners and give them some challenges in terms of providing other students or even teachers in case of ICT-related questions? At ASW, we are about to integrate a student ICT team called “Junior IT-Supporter” in our concept. But this is just one point of the respective concept, which will be extensively discussed in the following.

3.1.1 Situation at the time of tablet integration

As was described above, the tablet-related concept is closely related to the general pedagogical concept of the ASW, which is pointed towards the individual development and promotion of the students. They are learning in a self-directed way and teachers are more or less understood as educational companion who can be asked in case of uncertainty or questions. For this system, equipping every student with his own digital device seems to be a proper way of facilitating the learning processes.

One aspect worth mentioning is the decision for really equipping every single student with one Apple iPad Air using a leasing model, which leads towards the discussion whether students are allowed to use the devices in private context, too. Since especially the private using space allows for extensive media educational experiences, we decided that students are not only allowed to use the devices in private context, but also that they are being motivated to do so. Following this argumentation, it's both the teachers and the parents who have to support students in case of problems and questions. Since parents are just partially involved in these digital devices, workshops for parents of students are an aspect of particular importance, too.

Another aspect of importance is the personal responsible for the introduction of the new devices, which in the case of ASW are two regular teachers. Integration of the tablet computers had to take place during regular school semester, causing demands from the teachers, students and especially the organizing team. Of course, respective teachers had to do most of the related work besides their regular lessons, depicting the given system-dependent limitations. This also shows the meaning of an early and sufficient development of a detailed technical as well as pedagogical tablet computer concept. Without it, the necessary work might overwhelm respective teacher personal.

3.1.2 Educational Concept

To enable to relate to the situation at ASW, a short timetable should be given at this point presenting the first steps towards the tablet-integration at the school (see table 1). Because of the immense demands, all teachers of ASW were trained in terms of an Apple Professional Development (APD) training, including first steps towards using tablets, but also including specific subject-related ideas for classroom use. By this procedure, anxiety and skepticism of most participants could be reduced. As was described above, the students need some sort of training, too, especially related to technical possibilities of the devices but also to security issues such as password security or the use of mobile and wireless connected internet. In specific, the amount of training at the beginning of iPad integration is supposed to be higher than some time after the beginning. This leads to the punctual necessity of support, which supposedly cannot be given by regular teacher stuff.

At this point, one possibility is an external company, which regularly is way too expensive for schools and, thus, in most cases unrealistic. Another opportunity is the development of the above mentioned concept of Junior IT-Supporters, which have to be trained in advance but can be motivated by, e.g., a certificate. These might be able to answer some of the basic questions of students, and thus are supposed to massively lower the long-term every-day involvement of respective teacher personal.

In a long-term view, most of the below mentioned requirements are from time to time coming back again, at least every year where new students are coming to school and have to get equipped with tablets, too. Furthermore, concepts like this are in need of an ongoing critical evaluation, analyzing and supporting the related processes. Extensive information about the evaluation of the presented concept cannot be given at this point, because the related concept is just at working status at the moment. Nevertheless, it is planned to include quantitative paper-based questionnaires as well as qualitative interviews with students and teachers.

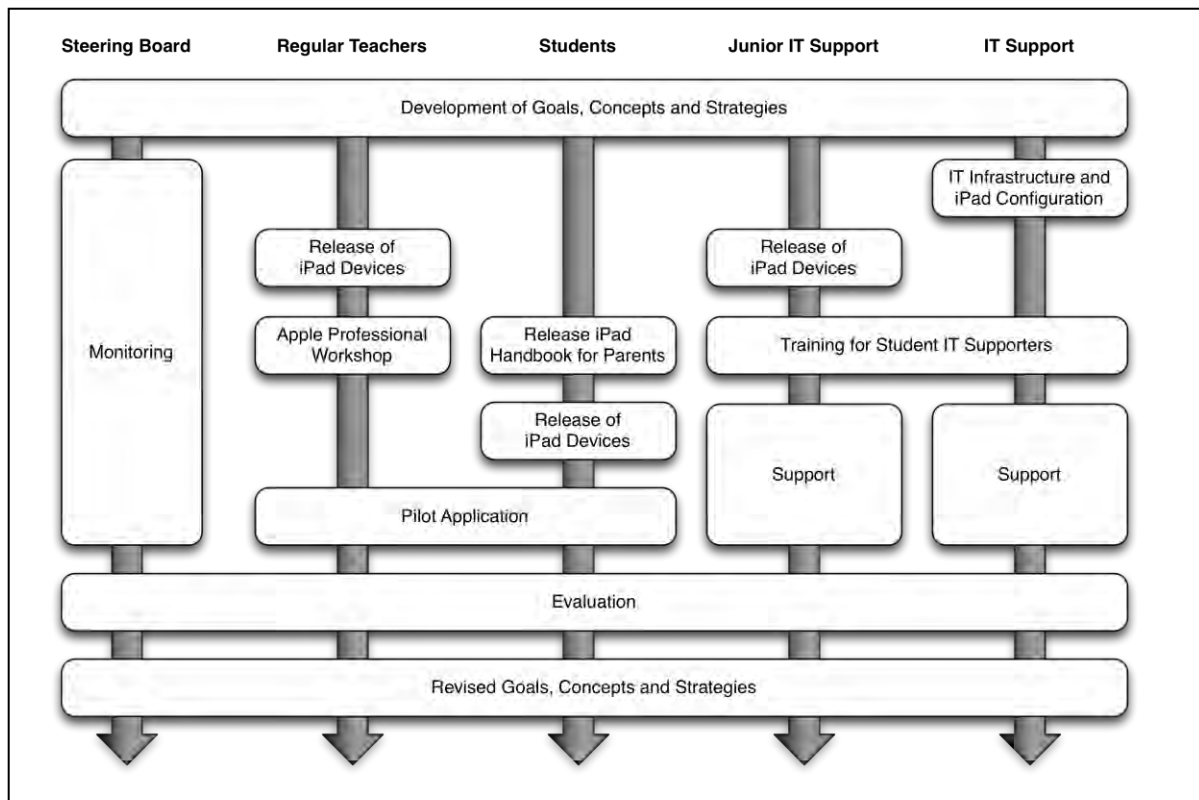

Table 1: First steps towards the implementation of a One-to-One tablet solution at ASW.

3.1.3 Resulting Checkpoints for the Integration

From the actual point of decisions and experiences during the first months before introduction of the tablet devices, some advices can be given for implementing a One-to-One tablet learning solution. It is supposed that these checkpoints are covering all necessary aspects, but whether or not these aspects proved to be good in the given context, is to be proven in terms of the evaluation. At this point, we cannot give extensive information on evaluation results or else, since first evaluation results will be available at the end of September, 2014.

- **Think about the effort that comes with the tablet PC integration.** How can the tablet devices be organized? Is it practicable for your school to administrate the devices, do you need an extern supporter? What are the consequences for the technical equipment at school (e.g., the network?).
- **Decide, which system you will use.** This decision has to be carefully taken in respective of the given preconditions. Because of the variety of possibilities, some helpful hints might be: What system do you use on your school computers? In case you use Apple iOS, it's a lot easier to use iPads than, for instance, Google Android tablets. What is your local ICT supporter good at? What's the opinion of students, parents and teacher stuff?
- **Carefully choose the point of delivery.** It's not important to deliver the devices as fast as possible to teachers and students, but to have a practicable implementation concept before delivery. At least, some stepstones should be clear. Otherwise, the risk of missing structure is at hand what might lead to long-term problems such as missing use standards or missing support structures.
- **Don't leave the students alone with the new device.** Students will be motivated and interested, but will also need support related to, e.g., security issues or taking responsibility for the device.
- **Discuss the concept in advance.** The respective concept is to be discussed with teachers as well as with students to broaden the acceptance of the devices as well as the concept. This is a factor of underestimated importance in terms of really changing individuals internalized procedures and thinking (cf. El-Gayar, Moran, and Hawkes, 2011), which is linked to literature on technology acceptance and the corresponding theories (Fishbein & Ajzen, 1975).
- **Don't forget the parents!** In this case, students were also allowed to use the devices at home, (and not to forget: parents are supposed to pay the leasing fee in our case!). It's thus an essential part to keep the parents involved. They need training, support and understanding for their sorrows, too – just the way students and teachers need it, when they are confronted with a new device.

- **Teachers need ongoing support!** They are in need for trainings related to the new devices. It's not just how to privately use the device and to learn some basic facts on it, but also how to implement the devices in different learning scenarios and working schemata.
- **Use given resources!** There's always the question how the effort can be overcome. Think about ICT literate students supporting other students and thus minimizing the effort for teacher personal.
- **Question your way.** Think about the possibility of a practicable and ongoing evaluation with low additional effort to reveal problems of integration of tablet computers in schools.

Keeping these checkpoints in mind during the integration of technical devices in learning scenarios, chances are good that new devices really get integrated in learning. Furthermore, these aspects are not just applying for the tablet device integration at schools, but also for other technical devices such as laptop computers or smartphones.

4. Future Work and Conclusions

The presented article discusses the potential of One-to-One tablet configurations in terms of formal educational system and finally highlights the relevance of different dimensions which have to be taken into account when thinking about an One-to-One tablet equipment. On this basis, it finally presents checkpoints for the integration of tablet computers in schools, which resulted from an adequate literature review as well as extensive discussions with school principal and respective teachers. These can also be understood as dimensions fostering or restrain the integration of tablet computers, showing a good starting point for the development of respective qualitative and quantitative research approaches. Nevertheless, the above named aspects are in need of evaluation in short-, middle- and long-term view. First experiences as well as first evaluation results will be named in the forthcoming presentation.

References

- Armstrong, A. (2014). Technology in the Classroom It's Not a Matter of 'If,' but 'When' and 'How'. *Education Digest*, 79(5), 39-46.
- Carvalho, A. M. A. (2011). Laptops for Students: Strength and Weakness of the Portuguese Initiatives. Proc. ISATT 2011. Braga, Portugal. Online: http://repositorium.sdum.uminho.pt/bitstream/1822/15931/1/ISATT2011_Laptop_Students.pdf (Last checked: 18.5.2014).
- Culén, Al. L., and Gasparini, A. (2011). iPad: A New Classroom Technology? A Report From Two Pilot Studies. In Clive Billness; Annette Hemera; Vladimir Meteljan; Mihaela Banek Zorica; Hrvoje Stancic & Sanja Seljan (ed.), *Information Sciences and e-Society*. Department of Information Sciences, University of Zagreb. pp. 199 - 208
- El-Gayar, O., Moran, M., and Hawkes, M. (2011). Students' Acceptance of Tablet PCs and Implications for Educational Institutions. *Educational Technology & Society*, 14 (2), 58–70.
- Fishbein, M., and Ajzen, I. (1975). *Belief, Attitude, Intention and Behavior: An Introduction to Theory and Research*. Reading, MA: Addison-Wesley.
- Foot, C. (2012). *The Evolution of a 1:1 iPad Program*. Online: www.internetatschool.com, (Last checked: 15.5.2014).
- Griffley, J. (2012). Gadget and Gizmos: Libraries and the Post-PC Era – The Rise of the Tablet. *Library Technology Reports*, 48(3), 7-13.
- Hahn, J., and Bussell, H. (2012). Curricular Use of the iPad 2 by a First-Year Undergraduate Learning Community. *Library Technology Reports*, 48(8), 43-47.
- Ludwig, L. (2014). Tablet-Schools in Germany. Online: <http://www.luise-ludwig.de/tabletprojekte/ergebnisse/> (Last checked: 21.8.2014).
- Johnson, L., Adams Becker, S., Cummins, M., Estrada, V., Freeman, A. and Ludgate, H. (2013). *NMC Horizon Report: 2013 Higher Education Edition*. Austin, Texas: The New Media Consortium.
- Lee, M., and Levins, M. (2012). *Bring Your Own Technology*. Acer Press.
- McPhail, J., and Paredes, J. (2011). One urban district's digital learning revolution. Leadership, September/October. Online: <http://riversidevirtualschool.net/JaysLeadershipArticle--Sept2011.pdf> (Last checked: 15.5.2014)
- Miller, W. (2012). iTeaching and Learning – Collegiate Instruction Incorporating Mobile Tablets. *Library Technology Reports*, 48(8), 54-59.
- O4NT (2014). Schoolmodel Steve JobsSchool. Online: http://o4nt.nl/wp-content/uploads/2013/01/o4nt_Boekje_V7.pdf. (Last checked: 15.5.2014)
- Ritzhaupt, A. D., Feng, L., Dawson, K., and Barron, A. E. (2013). Differences in Student Information and Communication Technology Literacy Based on Socio-Economic Status, Ethnicity, and Gender: Evidence of a Digital Divide in Florida Schools. *Journal of Research on Technology in Education*, 45(4), 291-307.

CHiLOs: A New Virtual Learning Environment for Large Scale Online Courses

Masumi HORI^{a*}, Seishi ONO^{a,b}, Shinzo KOBAYASHI^c, Kazutsuna YAMAJI^d & Toshihiro KITA^e

^a*NPO CCC-TIES, Japan*

^b*Musashi Academy, Japan*

^c*smileNC&co., Japan*

^d*National Institute of Informatics, Japan*

^e*Kumamoto University, Japan*

**hori@cccties.org*

Abstract: This research reports the development of a new online platform for Large Scale Online Courses (LSOCs) that combines e-textbooks and a Learning Management System (LMS) such as Moodle or Canvas in an effort to increase course completion rates. The platform, called Creative Higher Education Learning Objects (CHiLOs), consists of e-textbooks, e-lectures, digital badges, and learner's communities.

Keywords: Peer-to-peer learning, Open Education, Large Scale Online Courses, e-book, e-textbook Learning Management System, GakuNin, Massive Open Online Courses, lurker

1. Introduction

One of the main goals of Massive Open Online Courses (MOOCs) like Coursera and edX is to make higher education available to everyone. Many people worldwide experience barriers to higher education such as social restrictions, geographical disadvantages, and academic expenses. Anyone who wants to study at higher education institutions should be able to learn any time and any place. Large Scale Online Courses (LSOCs) using videos, assigned readings, and problem sets can provide hundreds or thousands of learners with access to higher education in a stable format.

LSOCs provide access to learning content, distributed content, and virtual learning environments (VLE) after users apply for the course and are authenticated (see Figure 1). However, LSOCs face some challenges:

- **Network stability:** Relying on a specific vendor (vendor lock-in) causes less stable operations. This was seen when Coursera experienced a partial outage caused by failure of the Amazon Web Services system (Gupta, 2012).
- **User authentication:** Biometric authentication and video monitoring are less cost-effective than examination at the traditional classroom (Arnold, 2013; Young, 2012).
- **Completion rate:** The average completion rate of a MOOC is less than 10% (Hill, 2013).
- **Peer-to-peer learning:** The face-to-face learning experienced in traditional classroom environments is not always possible in LSOCs because a number of learners.
- **Ubiquitous learning environment (ULE):** The use of the web paradoxically prevents diverse learners from studying in the ULE (Yang, 2006).

The authors propose an architecture for LSOCs using e-textbooks as a learning management system (LMS) interface, 1-minute nano lectures, and Academic Identity Federations (AIF) (see <http://refeds.org>) by dealing with open education in Japan's higher educational community as well as focusing on lurkers and tutors called by Connoisseur such as experts in our online communities. E-textbooks are advantageous due to their portability and learnability (Jamali et. al., 2009). Therefore, our user-friendly LMS interface using e-textbooks can create a ULE for diverse learners regardless of their computer skills or network access.

Scope of LSOCs

Content		Learning content
Content platform		Distributed content
User authentication	Application	Distributed VLE
Cloud computing	High performance computing	
	High-speed networks	
High-speed internet services		

Figure 1. Scope of LSOCs

2. CHiLOs project

2.1 CHiLOs structure

We developed the Creative Higher Education Learning Objects (CHiLOs) project for open online courses in Japan. CHiLOs consist of 1-minute lectures, e-textbooks, digital badges, and learners' communities (Figure 2).



Figure 2. CHiLOs structure

Through the CHiLOs project, the authors of this paper aim to develop a new VLE based on an e-textbook user LMS interface called CHiLO Book. The CHiLOs' VLE consists of 1-minute nano lectures called by CHiLO Lecture and will provide digital badges called by CHiLO Badge based on the user authentication by means of the AIF. Additionally, each CHiLO Book is granted a digital object identifier (DOI) (see <http://www.doi.org>) to ensure that it is traceable and is discoverable in web searches. Finally, CHiLO Book will contain varied Internet resources to replace a traditional web browser (Hori et al., 2012; 2013). These elements will achieve a flipped classroom, which may facilitate the creation of several small communities of learners within the LSOC called CHiLO Community; peer-to-peer learning will be achieved through these communities. The CHiLO Book and CHiLO Lecture distributed and the presented CHiLO Badge in the CHiLO Community will help develop educator-to-learner and learner-to-learner links and further promote mutual understanding of the educational content.

2.2 Lurkers in online communities

90% of the users in most online communities accessed by the general public are lurkers who only browse and do not actively participate (Nielsen, 2006). In LSOCs, it is common for learners to drop out because they do not want to try a quick quiz or assignment and many do not contribute to message boards. This is referred to as pedagogical lurking (Dennen, 2008; Rodriguez, 2012) and such lurkers are prominent in MOOCs. In short, LSOCs should aim to motivate pedagogical lurkers to contribute.

2.3 CHiLO Lecture

In designing our system, we analyzed data obtained from an actual 2008 experiment with open courses involving 30,000 learners (Hori et al., 2013). As shown in Figure 3, the probability of the number of viewers decreased over viewing time.

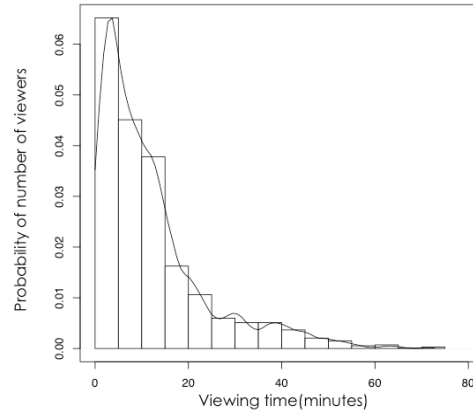

Figure 3. Learners' viewing time

The results of the experiment showed that most learners prefer short, 1-2 minute lectures. Therefore, in the present study, we focused on creating 1-minute nano lectures and developed an LMS interface using 1-minute nano lectures in CHiLO Book. This structure is called CHiLO Lecture.

A complete CHiLO course consists of 15 CHiLO Books and each CHiLO Book includes approximately 10 CHiLO Lectures. Learners receive a CHiLO Badge after they complete each the CHiLO Book and the CHiLO course. Diverse learners and lurkers can easily and repeatedly access these short lectures and gain CHiLO Badges. The present study showed that repeatedly viewing a series of CHiLO Lectures and receiving CHiLO Badges for completing assignments provided the same learning effects as “the mastery learning approach” advocated by Bloom in Coursera’s experiment (Do et al., 2013).

2.4 Peer-to-peer learning in CHiLO Community

LSOCs should be diverse enough to attract a wide range of learners, including lurkers. Lurkers have a tendency to passively disseminate and search for information (Bishop, 2007), and supportive learning communities can help them become more interactive. Peer grading in MOOCs is currently not adaptable to lurkers who only browse and lack motivation. Although face-to-face teaching is required for learners on LSOCs, it is impossible for so many learners.

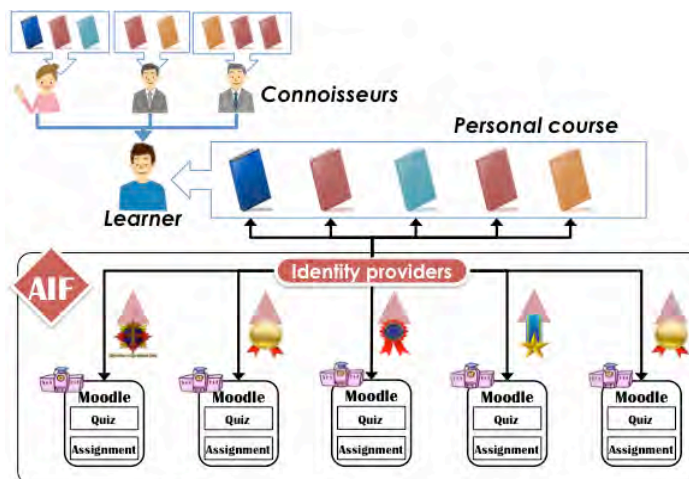

Figure 4. Relationship between educational Connoisseur and learners

We propose new peer reviews of the CHiLO Lecture, encouraging learners to become Connoisseur. University educators manage learning communities in traditional higher education online courses; however, learners themselves organize the communities in peer-to-peer learning. Our Connoisseurs are not teachers, but reputable learners. They create small groups or classroom communities, support learners through peer-to-peer learning, and integrate information according to the learners' levels. Figure 4 shows the relationship between Connoisseurs and learners in CHiLO Communities using CHiLO Books with AIFs (<https://refeds.org/resources/>) of which authentication trust framework is maintained by each country..

3. Implementation of CHiLO Book and CHiLO Badge in CHiLO Community

CHiLO Book and CHiLO Badge are developed under the above-mentioned concept of peer-to-peer learning in CHiLO Community. Figure 5 shows the development of CHiLO Book, CHiLO Badge, and CHiLO Lecture.

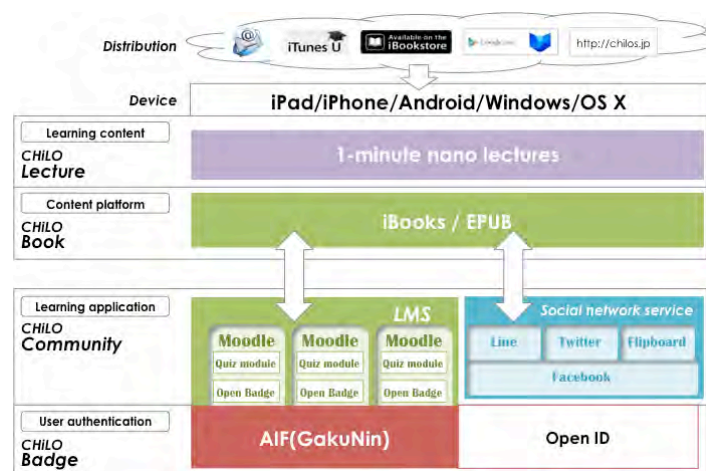

Figure 5. Components of LSOCs by the CHiLO Books

3.1 Moodle-based development using GakuNin

The LMS of CHiLO Book was configured and developed on Moodle, a commonly used open source LMS, using the present Application Programming Interface (API). Since Moodle is an open source system, each university can run it independently. Moodle 2.x is the basis of the CHiLO LMS, so Open Badge from the Mozilla Foundation can be issued as CHiLO Badge. The Moodle LMS have to be configured to activate SAML authentication and then be registered as one of the service provider in GakuNin; the Japanese AIF. This helps us to solve the identity management issues in LSOCs in the sense that providing and updating GakuNin user data is the responsibility of the affiliated universities (Yamaji et al., 2010).

3.2 CHiLO Book configuration

A typical CHiLO Book is about 20 pages and consists of a lecturer video, a lecture summary, lecture content and a unit examination. There are 1-minute lectures, the lecture scripts, slides, a link to a comment box allowing the user to post to Facebook, and each page of the book has a link to quizzes on the material presented.

4. Discussion

4.1 Micro LSOCs in CHiLOs

Online content in CHiLO Lectures is divided into 1-minute nano lectures. Online content in CHiLO Books is distributed by many LMSs using e-textbook interfaces. CHiLO Community encourages peer-to-peer learning so that each individual in the community becomes an active learner as well as a Connoisseur. Therefore, the CHiLO project consists of various micro systems distributed within LSOCs.

The benefits of micro LSOCs in the CHiLO project are as follows:

- CHiLO Book has desirable features for VLE which have scalability for distributed systems in LSOCs.
- CHiLO Lecture enhances learning effects through distributed 1-minute nano lectures that learners can repeatedly study.
- CHiLO Community creates a supportive peer-to-peer VLE for lurkers because the content is easily accessible and do not to require learners to be computer literate.

However, micro LSOCs in the CHiLO project also have the following disadvantages:

- Management of the integrated system for the distributed LMS is complicated. Therefore, it is difficult to process high volumes of data relevant to learners' private information and learning outcomes.
- Creating many 1-minute lectures is laborious and requires specific skills and knowledge.

4.2 *Integrated micro LSOCs*

CHiLOs' distributed architecture enables scalability of LSOCs. Learners are required to find the relevant information from the distributed learning resources. That is, connecting with other learners who have a similar learning target is an important functionality offered by CHiLOs.

Within a CHiLO course, there is an option for users to allow their CHiLO Badges, which are issued from each individual LMS, to be aggregated into the main CHiLO LMS server. CHiLO Badges can contain embedded principal information of the learning process such as selected CHiLO Books, meaning that the CHiLO LMS server plays a role in allowing learners to discover and connect with each other. In addition, CHiLO Badges can be seen as a certification of user attributes, especially in the e-learning field. Although the identity provider in the AIF can provide minimum user attributes which are managed by the users' home organization, the CHiLO LMS server can provide additional course certificates in the form of CHiLO Badges. The CHiLO LMS server will play an important role as an attribute provider of micro LSOC networks based on the AIF.

5. Conclusion

The MOOCs movement has created a new educational environment that impacts a large number of learners. New merits of MOOCs are expected to emerge as a greater number of learners with different skills and values use the same VLE. On the other hand, Dennen (2013) showed that weaknesses such as prior experience, external vision, support needs, faculty incentive, and political climate are disadvantages of MOOCs. Furthermore, to provide stable and instructive services to many learners, we must radically change the way online learning is compared to traditional education.

In traditional education, university teachers provide educational content to students according to the curriculum (content platform) designed by the university. Students physically gather on a campus to receive guidance from the teachers. The university provides accreditation for their achieved learning outcomes. In other words, universities centrally manage all aspects of a student's learning. This method can only provide learning opportunities to a limited number of people and is unable to fulfill the learning demands of modern society.

CHiLOs LMSs are designed not only to serve as a system that conforms to LSOCs, but also to significantly change the framework of traditional education. In traditional education, universities only exist to grant degrees and teachers just transmit information. In future LSOCs, there will be significant changes to academics as students can freely select the content that they want to learn and create their own curriculums.

Furthermore, the support provided to lurkers by introducing social network service and 1-minute nano lectures in the CHiLOs-based environment cultivates intellectual curiosity among learners and can be a good learning environment for increasing online course completion rates.

We believe that the educational roles of traditional universities should incorporate MOOCs and CHiLOs as they are better able to meet the diverse requirements of modern society. CHiLO book is one of many possible strategies universities could implement to meet the diverse educational needs of individuals, organizations, and society.

Acknowledgements

The authors thank the former members of the Education Support Office (ESO), Musashi Academy for their assistance and advice. The authors are grateful to Brian Masshardt Ph.D., former ESO Academic Coordinator, for his careful proofreading and useful comments. The authors also thank Yuka Ito, former ESO Assistant Coordinator, for her extensive translations and useful advice.

References

- Arnold, B. B. (2013, January 16). Coursera to Fight Online Cheating – But Do Biometrics Even Work? *The Conversation*. Retrieved from <https://theconversation.com/coursera-to-fight-online-cheating-but-do-biometrics-even-work-11567>.
- Bishop, J. (2007). Increasing participation in online communities: A framework for human–computer interaction. *Computers in human behavior*, 23(4), 1881-1893.
- Dennen, V. P. (2008). Pedagogical lurking: Student engagement in non-posting discussion behavior. *Computers in Human Behavior*, 24(4), 1624-1633.
- Dennen, V. P. et al. (2013, September). Shall We MOOC? A SWOT Analysis at the Program Level. In *MOOCs Forum* (Vol. 1, No. P, pp. 17-21). 140 Huguenot Street, 3rd Floor New Rochelle, NY 10801 USA: Mary Ann Liebert, Inc..
- Do, C. B. et al. (2013, September). Self-Driven Mastery in Massive Open Online Courses. In *MOOCs FORUM* (Vol. 1, No. P, pp. 14-16). 140 Huguenot Street, 3rd Floor New Rochelle, NY 10801 USA: Mary Ann Liebert, Inc..
- Gupta, T. (2012, October 22). Coursera Goes Down Leaving Almost One Million Users Stranded. *Examiner.com*. Retrieved from <http://www.examiner.com/article/coursera-goes-down-leaving-almost-one-million-users-stranded>.
- Hill, P. (2013, March 10). Emerging student patterns in MOOCs: A (revised) graphical view. *e-Literate*, [Web log post]. Retrieved from <http://mfeldstein.com/emerging-student-patterns-in-moocs-a-revised-graphical-view/>.
- Hori, M. et al. (2012). TIES e-Portal 2.0 Trials for Making Innovations in Open Education. In *6th International Conference on Project Management*. 264-269, 2012, October 3-5, Honolulu, Hawaii, USA.
- Hori, M. et al. (2013). One-on-One Approach for Open Online Courses Focusing on Large-Scale Online Courses. In *5th International Conference on Computer Supported Education*, 177-182, 2013, May 6-8, Aachen, Germany.
- Hori, M. et al. (2013). Peer-to-peer Learning on Large Scale Online Courses : Focusing on Lurkers. In *6th International Conference on e-Learning and Innovative Pedagogies*, November 14-15, 2013, Madrid, Spain.
- Jamali, H. et al. (2009, January). Scholarly e-books: the views of 16,000 academics: Results from the JISC National E-Book Observatory. In *Aslib Proceedings* (Vol. 61, No. 1, pp. 33-47). Emerald Group Publishing Limited.
- Nielsen, J. (2006). Participation inequality: Encouraging more users to contribute. *Jakob Nielsen's alertbox*, 9, 2006. Retrieved from <http://www.nngroup.com/articles/participation-inequality/>.
- Rodriguez, C. O. (2012). MOOCs and the AI-Stanford Like Courses: Two Successful and Distinct Course Formats for Massive Open Online Courses. *European Journal of Open, Distance and E-Learning*, Retrieved from <http://www.eurodl.org/?p=archives&year=2012&halfyear=2&article=516>.
- Siemens, G. (2012). MOOCs are really a platform. *Elearnspace blog* [Web log post]. Retrieved from <http://www.elearnspace.org/blog/2012/07/25/moocs-are-really-a-platform>.
- Yamaji, K, et al. (2010). Japanese Access Management Federation GakuNin as an eResearch Collaborative Infrastructure. In *Open Conference Systems, eResearch Australasia 2010*.
- Yang, S. J. H. (2006). Context Aware Ubiquitous Learning Environments for Peer-to-Peer Collaborative Learning. *Educational Technology & Society*, 9 (1): 188-201.
- Young, J. R. (2013, November 13). American Council on Education May Recommend Some Coursera Offerings for College Credit. *The Chronicle Higher Education*. Retrieved from <http://chronicle.com/article/MOOCs-Take-a-Major-Step/135750/>.

Mobile 2.0 learning: Empowering mobile learning with socialized context sharing

Ming-Chi LIU^a, Yen-Ning SU^a, Nian-Shing CHEN^b & Yueh-Min HUANG^{a*}

^a*Department of Engineering Science, National Cheng Kung University, Taiwan, R.O.C.*

^b*Information Management Department, National Sun Yat-sen University, Taiwan, R.O.C.*

* Huang@mail.ncku.edu.tw

Abstract: With an experience in the development of web-based learning, mobile learning, and web 2.0-based learning, we have seen an emerging trend in the integration of web 2.0 technology into mobile learning, so called Mobile 2.0 Learning. By analyzing previous studies with the model of social cognitive theory, we reveal that their integration is not in conflict with each other; in contrast, Mobile 2.0 Learning may reframe the relationship between environments inside and outside of school. The social interactivity of Web 2.0 can improve students' sense of community and collaboration in mobile learning. Mobility and context capturing facilities can support learners to exchange information in daily life and further develop context-specific competences in an informal social community. This study first introduces the components of Mobile 2.0 learning and its unique characteristics. Next, the key elements driving Mobile 2.0 were illustrated by an example to show their processing flow. Finally, further research issues of Mobile 2.0 learning were proposed. It is hoped to provide readers a potential research blueprint by this study.

Keywords: Mobile learning, Web 2.0, Mobile 2.0, social networking

1. Introduction

In recent years, researchers have focused on the use of mobile devices to facilitate students' learning, called mobile learning. For example, (Y. S. Chen, Kao, & Sheu, 2003) demonstrated that embedding an encyclopedia of ecology in mobile devices might help students to better understand animals they may encounter. Smordal and Gregory (2003) also showed that use of mobile devices could provide learners more immediate and relevant knowledge, and might help their problem solving. In addition, a mobile device supporting a guide agent could suggest students an effective path when visiting certain wetlands (Tan, Liu, & Chang, 2007). In short, one benefit of mobile learning is to help learners to understand content immediately and efficiently (Hsiao, Lin, Feng, & Li, 2010).

The other major advantage of mobile learning is to connect students to nature, which is a knowledge-enriching experience (Maldonado, Pea, Spikol, & Milrad, 2010). As noted by Wan and Lam (2010), students perceived authentic objects or examples can acquire a deep understanding of concepts. Roschelle (2002) also pointed out that mobile learning could effectively motivate learning by augmenting physical space, leveraging topological space, and aggregating coherently across all students. In other words, mobile learning helps encourage students to explore the outdoors and learn actively.

While considerable attention paid to either mobile learning or web 2.0-based learning, the current development still has much room to advance (Frohberg, Gothe, & Schwabe, 2009). For example, Frohberg et al. (2009) found that most mobile learning projects occur in independent and formalized contexts, but hardly in a socializing context. Similarly, Hughes (2009) noted that there was high use of Web 2.0 tools for playful activities, but low use for collaborative knowledge construction. To cope with these limitations though involving an experience in the development of both technologies, we have seen an emerging trend in the integration of web 2.0 technologies into mobile learning, so called Mobile 2.0

learning (M2L). Our main goal thus is to introduce educators an innovative instructional tool and provide researchers a potential research blueprint.

2. The components of Mobile 2.0 Learning

In recent years, we have seen mounting evidence of the usefulness of educators' incorporating E-learning systems into their teaching, but we also noticed a shift in patterns of E-learning systems. The ensuing section describes each type of environment that configures M2L. Figure 1 shows the relationships among Mobile learning, Web 2.0-based learning, and M2L.

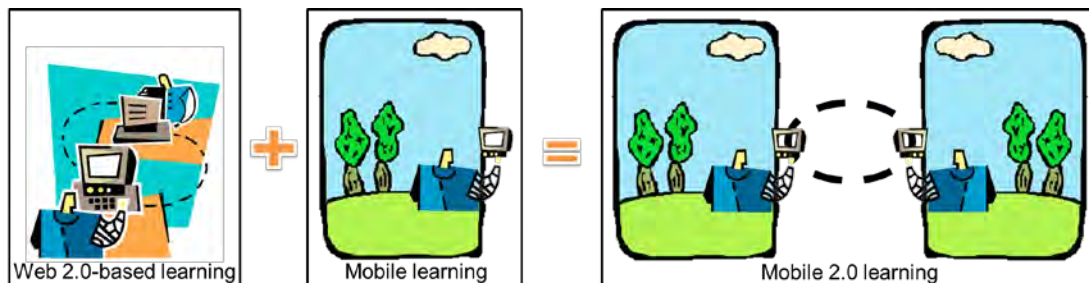

Figure 1. Relationships among web 2.0-based learning, mobile learning and "Mobile 2.0 learning"

Nowadays, many students are used to communicating with each other through voice or short messages by mobile phones. Traditionally, students used mobile devices mainly to *pull* resources passively from web-based contents (Sharples, 2002). Contrary to passively accessing traditional web-based contents, most students are now willing to actively use Web 2.0 technologies to create, *push* and share information. For example, students can actively upload learning content or a lecture video in a blog system. Peers can immediately access the information just uploaded and then post their responses to it. However, these prompt *pull* and *push* actions are foiled by using desktop computer facilities (Y. M. Huang, Jeng, & Huang, 2009).

Thus, the integrated M2L cannot be defined simply as extending the Web 2.0 services to mobile learning. What is more, through the convergence of the social interaction and situated learning, M2L should reshape a new paradigm of educational experience for instructors and learners.

3. The key elements driving Mobile 2.0 learning platforms

The analysis in the former section showed that the purpose of MW2 is to create higher levels of interaction and value-added outcomes through the integration of learning contents and contextual information. As follows, aggregation, dynamics, sensors and alerts are the key elements in driving M2L:

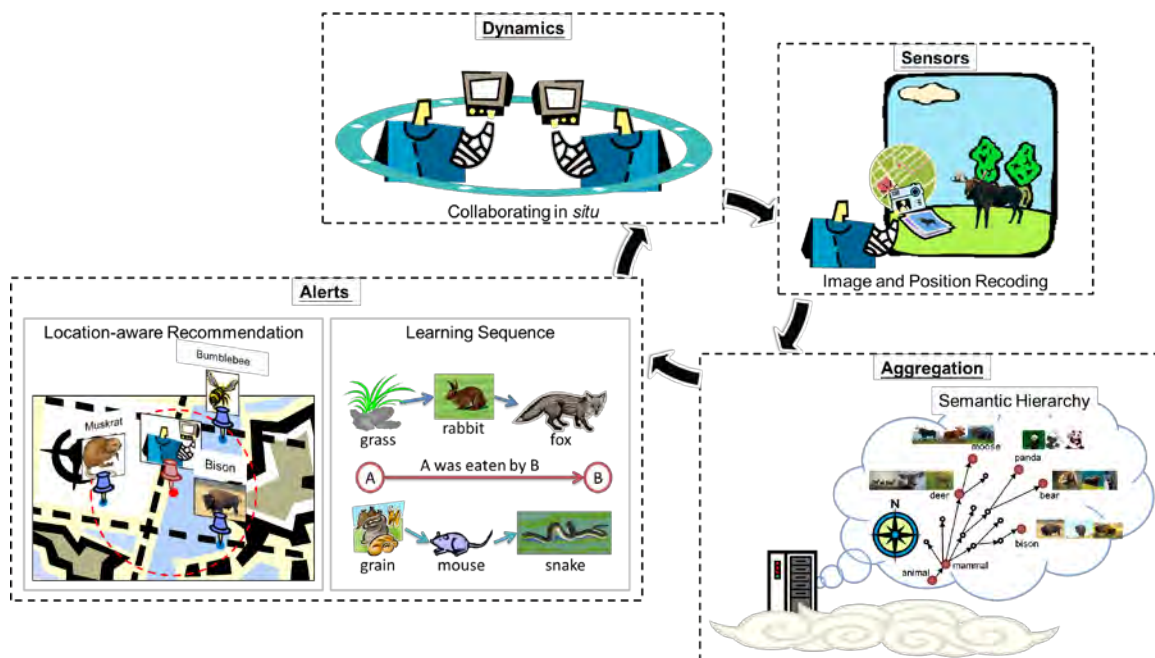

Figure 3. Illustrative example of the processing flow of the four key elements supporting the mobile 2.0-based ecological learning

Aggregation is a key interface element for M2L. The functionality of an aggregation is to harness collective intelligence (Bosse, Jonker, Schut, & Treur, 2006). Thus, it is necessary to create content, represent it with the current context, and publish it to the web. For example, G. D. Chen and Chao (2008) developed a web-based discussion forum for collecting students' contextual messages from traditional paper textbooks, and then to facilitate collaboration among community members and offer timely, contextual assistance in students' study based on their reading status.

Because mobile devices generally suffer from limited resources, the usability of an aggregation is a vital element driving the usability of M2L. Therefore, the interactive means provided by mobile devices must be short and make learners willing to communicate more frequently and instantly in a natural environment (Counts & Fisher, 2010). The learning management system (LMS) could be modified to achieve this goal. Environment implementers need to take responsibility for the usability of the aggregation, not just by easily gathering content, but also by representing content according its context. Summarization methods serve as an intermediate agent to build effective aggregation for interchanging content on different mobile devices (Carpineto, Mizzaro, Romano, & Snidero, 2009).

Dynamics refers to the capability of M2L to create a host of collaborative environments caused by both the mobility of devices and the varied contextual information of individuals. M2L environments will create dynamic grouping techniques. These techniques can group learners based on the instantaneousness of their context (N. S. Chen, Kinshuk, Wei, & Yang, 2008; El-Bishouty, Ogata, Rahman, & Yano, 2010; J. J. S. Huang, Yang, Huang, & Hsiao, 2010). On the one hand, learners can provide their knowledge according to its contextual information and get a deeper understanding of concepts through a merged view of context. On the other hand, learners will interact with each other in a heterogeneous group because this kind of grouping will have a higher variety within a group (Hooper & Hannafin, 1988).

Sensors provide the rich situated contexts for M2L experience. Besides location, sensors will capture more of the learners' surrounding information such as data-logger, audio recording, photo, camera, physiological signals, and so on. A true M2L application will integrate these sensor data to know the exact context of your surroundings as well as your profile of preferences and then match them with relevant learning services and learning contents. For example, Hsiao et al. (2010) offer a location-based service to present the learning materials and activities related to the learning zone to the students automatically.

Alerts let you know what you need to know. Many mobile learning applications are already taking advantage of alerts, which can notify learners of a variety of events, such as moments of vocabulary learning (C.-M. Chen & Chung, 2008) and recommendations for peer mentors depending on one's schedule (G. D. Chen, Chang, & Wang, 2008). Nevertheless, as learning becomes Mobile 2.0, new opportunities for motivation enhancement will emerge: for example, noticing near learning companions (J. J. S. Huang et al., 2010), guiding a student to the target learning object (Hwang, Kuo, Yin, & Chuang, 2010), or recommending a learning task according to a learner's context (Ogata, Saito, Paredes, Martin, & Yano, 2008).

Figure 3 depicts an illustrative example of a hypothetical learning process driven by the four key elements of Mobile 2.0 tools. Consider the "Identification of Animals" task in a natural science course of an elementary school. First, the students discuss the characters of the deer family in their own micro-blog, which can be grouped by their instant interests. Students can temporarily collaborate to understand the similarity and differences among the deer family's animals. This can be done even with students who are not in the same city or country. Next, students can visit zoos, villages, or wildlife parks to investigate the species of deer near their places. If students meet a Moose in the field, they can take a picture of the moose as well as embed the contextual information such as the original geographic position and the moose's voice in the image. Moreover, students can use a data-logger to collect environmental information such as temperature, humidity, or the pH of water and soil. The sharing of *in situ* behavior could facilitate students to contribute their personal knowledge to the learning community. Third, when students finish the animal tour, they can send the surveyed data to update the knowledge aggregation on the cloud-based server. This aggregation can represent the deer family with a hierarchical knowledge structure. The hierarchical knowledge structure can summarize the tree items into a compact tree according to the students' context. Finally, during the next tour, the students can request and receive information about the other nearby animals. With the support of semantic technology (e.g., the feeding relationships between animals), it is possible to recommend an adaptive learning sequence and students will be able to acquire a deep understanding of the concept of feeding relationships in an ecosystem.

4. Conclusions

M2L can create a learning environment that is authentic, collaborative, communicative, engaged, and effective. It also can provide improved collaboration efficiency, enhanced learner communication, increased content contextualization, and continuous interactivity. Current implements are already demonstrating the effect of collaborative context sharing with mobile devices, even though they are pilot investigations and affective in orientation. However, a great deal of research effort is required to realize the complete idea of M2L and to understand its pedagogical implications.

Finally, it is worth emphasizing that M2L is not a replacement of other types of learning environments, but an extension of them since the M2L concept is complementing the features of web-based learning, mobile learning and Web 2.0 concepts. In the ideal situation, M2L will be expected to support a real-situated collaborative learning, where the feature of context-awareness comes from the portability and flexibility of mobile devices, and the feature of collaboration comes from the people's interactivity of the Web 2.0. Before such situations can be achieved successfully, we need to address these challenges and further research issues explored in this study.

Acknowledgements

This study is conducted under the "Cloud computing systems and software development project(3/3)" of the Institute for Information Industry which is subsidized by the Ministry of Economy Affairs of the Republic of China. This research is partially supported by the "International Research-Intensive Center of Excellence Program" of NTNU and Ministry of Science and Technology, Taiwan, R.O.C. under Grant no. NSC 103-2911-I-003-301, NSC 102-3113-P-006-019-, MOST 103-2511-S-006-007-MY3, and MOST 103-2511-S-006-002-MY3.

References

- Bosse, T., Jonker, C. M., Schut, M. C., & Treur, J. (2006). Collective representational content for shared extended mind. *Cognitive Systems Research*, 7(2-3), 151-174. doi: 10.1016/j.cogsys.2005.11.007
- Carpineto, C., Mizzaro, S., Romano, G., & Snidero, M. (2009). Mobile information retrieval with search results clustering: Prototypes and evaluations. *Journal of the American Society for Information Science and Technology*, 60(5), 877-895. doi: 10.1002/asi.21036
- Chen, C.-M., & Chung, C.-J. (2008). Personalized mobile English vocabulary learning system based on item response theory and learning memory cycle. *Computers & Education*, 51, 624-645.
- Chen, G. D., Chang, C. K., & Wang, C. Y. (2008). Ubiquitous learning website: Scaffold learners by mobile devices with information-aware techniques. *Computers & Education*, 50(1), 77-90. doi: 10.1016/j.compedu.2006.03.004
- Chen, G. D., & Chao, P. Y. (2008). Augmenting traditional books with context-aware learning supports from online learning communities. *Educational Technology & Society*, 11(2), 27-40.
- Chen, N. S., Kinshuk, Wei, C. W., & Yang, S. J. H. (2008). Designing a self-contained group area network for ubiquitous learning. *Educational Technology & Society*, 11(2), 16-26.
- Chen, Y. S., Kao, T. C., & Sheu, J. P. (2003). A mobile learning system for scaffolding bird watching learning. *Journal of Computer Assisted Learning*, 19(3), 347-359.
- Counts, S., & Fisher, K. E. (2010). Mobile social networking as information ground: A case study. *Library & Information Science Research*, 32(2), 98-115. doi: 10.1016/j.lisr.2009.10.003
- El-Bishouty, M. M., Ogata, H., Rahman, S., & Yano, Y. (2010). Social knowledge awareness map for computer supported ubiquitous learning environment. *Educational Technology & Society*, 13(4), 27-37.
- Frohberg, D., Gothe, C., & Schwabe, G. (2009). Mobile Learning projects - a critical analysis of the state of the art. *Journal of Computer Assisted Learning*, 25(4), 307-331. doi: 10.1111/j.1365-2729.2009.00315.x
- Hooper, S., & Hannafin, M. J. (1988). Cooperative CBI - The effects of heterogeneous versus homogeneous grouping on the learning of progressively complex concepts. *Journal of Educational Computing Research*, 4(4), 413-424.
- Hsiao, H. S., Lin, C. C., Feng, R. T., & Li, K. J. (2010). Location based services for outdoor ecological learning system: Design and implementation. *Educational Technology & Society*, 13(4), 98-111.
- Huang, J. J. S., Yang, S. J. H., Huang, Y. M., & Hsiao, I. Y. T. (2010). Social learning networks: Build mobile learning networks based on collaborative services. *Educational Technology & Society*, 13(3), 78-92.
- Huang, Y. M., Jeng, Y. L., & Huang, T. C. (2009). An educational mobile blogging system for supporting collaborative learning. *Educational Technology & Society*, 12(2), 163-175.
- Hughes, G. (2009). Social software: new opportunities for challenging social inequalities in learning? *Learning Media and Technology*, 34(4), 291-305. doi: 10.1080/17439880903338580
- Hwang, G. J., Kuo, F. R., Yin, P. Y., & Chuang, K. H. (2010). A Heuristic Algorithm for planning personalized learning paths for context-aware ubiquitous learning. *Computers & Education*, 54(2), 404-415. doi: 10.1016/j.compedu.2009.08.024
- Maldonado, H., Pea, R. D., Spikol, D., & Milrad, M. (2010, April 12-16). *Let's go! to the Creek: co-design of water quality inquiry using mobile science laboratories*. Paper presented at the 6th IEEE International Conference on Wireless, Mobile and Ubiquitous Technologies in Education WMUTE 2010, Kaohsiung, Taiwan.
- Ogata, H., Saito, N. A., Paredes, R. G., Martin, G. A. S., & Yano, Y. (2008). Supporting classroom activities with the BSUL system. *Educational Technology & Society*, 11(1), 1-16.
- Roschelle, J., & Pea, R. (2002, Jan. 7-12). *A walk on the WILD side: How wireless handhelds may change CSCL*. Paper presented at the International Conference on Computer-Supported Cooperative Learning, Boulder, Colorado.
- Sharples, M. (2002). Disruptive devices: Mobile technology for conversational learning. *International Journal of Continuing Engineering Education and Lifelong Learning*, 12(5/6), 504-520.
- Smordal, O., & Gregory, J. (2003). Personal Digital Assistants in medical education and practice. *Journal of Computer Assisted Learning*, 19(3), 320-329.
- Tan, T. H., Liu, T. Y., & Chang, C. C. (2007). Development and evaluation of an RFID-based ubiquitous learning environment for outdoor learning. *Interactive Learning Environments*, 15(3), 253-269. doi: 10.1080/10494820701281431
- Wan, S. W.-Y., & Lam, P. H.-C. (2010, April 12-16). *Students' voices: enriching learning experiences through M-learning*. Paper presented at the 6th IEEE International Conference on Wireless, Mobile and Ubiquitous Technologies in Education WMUTE 2010, Kaohsiung, Taiwan.

Enabling a Positive First Year Experience in Higher Education through Social Media and Mobile Technologies

Shaun NYKVIST*, Michelle MUKHERJEE & Kelli McGRAW

Queensland University of Technology, Australia

*s.nykvist@qut.edu.au

Abstract: The first year experience for students within Higher Education institutions has become increasingly important as these institutions strive to improve student retention rates. With many universities also focusing on transforming teaching and learning in an effort to attract and retain students, there is a growing demand to understand and respond to individual student requirements, such as the need to feel a sense of belonging. The literature identifies a sense of belonging as being paramount to a student's satisfaction with the institution and it is within this context that this paper reports on a three year study of how first year pre-service education students use social media and mobile technologies in their personal lives and their formal education. More specifically, the study identifies trends in the use of these technologies and the growing need for students to use digital media sharing tools to connect and engage with their peers. The paper contrasts the differences in use between these groups as it seeks to identify the role these technologies can play in their teaching and learning, as well as in promoting an overall positive first year experience.

Keywords: Social Media Technology, Mobile, First Year Experience, Connected Technologies, Pre-Service Education, Higher Education, Sense of Belonging

1. Introduction

The Higher Education landscape is currently in a state of change with many institutions focusing on transforming their teaching and learning and attracting students through new online initiatives and courses. While the notion of adopting online tools to support teaching and learning is not new, many academic staff still struggle with ways to use these tools effectively to connect and engage with students, especially with the ever-increasing adoption of new social and mobile technologies by students. Teaching and learning experiences for students are often quite mixed, with reports of dissatisfaction by students and a gap between how students perceive satisfaction and how instructors perceived satisfaction. Most recently, this was reported by Khalil and Ebner (2013), as they explored the experiences of students in online courses, with a particular focus of their research being MOOCs.

In recent years, there has also been a “significant decline in the amount of time first year students spend on campus” (James, Krause & Jennings, 2010, p.2) as more and more undergraduate students increase their working hours and rely on recorded lectures and online resources. Understanding the student and the challenges that face them as they enter into the higher education scene has become a necessity for educators. Consequently, many Higher Education institutions now have a focus on the first year experience of students with the aim of improving student success and retention. While the concept around retaining students is not new (Wilcox, Winn, Fyvie-Gauld, 2005) and there are many theories (see Jensen, 2011) aimed at retaining students, there is some consensus that inclusiveness and a sense of belonging may improve student satisfaction and retention (Hoffman, Richmond, Morrow & Salomone, 2002; Napoli & Wortman, 1998).

The literature concerning the First Year Experience in tertiary education highlights the need for students to feel a connection to their institution; students must “engage academically, socially and personally with their institution” (Nelson, Quinn, Marrington, & Clarke, 2012, p. 2). It is within this context that Menzies and Nelson (2012) identify peer development as being central to a student's personal and academic development. However, despite the importance of peer support, not all

students have equitable access to peers: impediments to such access can be work or family commitments, or differences in gender, age or cultural backgrounds (Menzies & Nelson, 2012).

The literature also discusses other first year experience concerns, such as feelings of intimidation experienced by academically weaker students when in group work settings. According to Wilkinson and Fung (2002), minority students often found group discussions to be dominated by majority group students, and many researchers have reported that in mixed gender groups, male students can be more active participants than female (e.g., Underwood, Underwood, & Wood, 2000). It is such social comparison concerns of first year students that have been shown to affect the academic outcomes of students (Micari & Drane, 2011). In identifying social comparisons and their impact, social comparison indices were derived from an instrument that asked students to agree or otherwise with statements concerning academic intimidation in a groupwork setting and self-efficacy. Bandura (1997) further defines self-efficacy as the beliefs the learner holds about his or her ability to perform well in a particular academic domain. Micari and Drane (2011) reported how initial self-efficacy was significantly related to social comparison concern and comfort in a cohort of undergraduate students in one institution, with students who dropped out reporting significantly higher levels of social comparison concern than those who remained. In their findings, social comparison concern was seen to be significantly higher for minority students at one measure, and generally higher for women than men. While this has been the case in face to face learning environments, online environments can provide different experiences for students, which will be discussed next.

Virtual environments allow all students to engage in peer to peer social and learning centred activities (Menzies & Nelson, 2012), and it is possible that the ambiguity of identity that social media affords might ameliorate the concerns raised above. McCarthy (2010) used the social media site Facebook to create connections between first year students and found that social media created links between the international and local students. The local students reported that although they were interested in engaging with students from different cultures: “sometimes it can be hard interacting with some of the international students because of the language barrier but with Facebook, because it was online, it was really easy and enjoyable - so many different perspectives and opinions coming together” (McCarthy, 2010, p. 5). It was also recognised that the “best thing about the Facebook galleries was that they got everyone talking from day one - all of sudden I had all these new friends on Facebook and from there had friends in class” (p. 5).

This study was interested in determining whether the extent of the literature reported student use of social media, was taking place in the researchers’ institution and how this contrasted with the patterns of usage from the academic staff teaching these first year students. Arteaga Sanchez, Cortijo and Javed (2014) assert that as academics “it is necessary to reach a full understanding of our students’ perceptions of Facebook for academic purposes” (p. 146). Their results reported that social influence was the dominant factor in predicting the adoption of Facebook, and maintaining social relations with people with whom they share interests was the most important purpose for using Facebook. Students believed that using Facebook would be “free of physical and mental efforts” (Arteaga Sánchez, et al., 2014, p. 146) and it would allow them to improve their communication, collaboration and information exchange. In addition to increasing collaboration with students and instructors, Facebook could create a more comfortable classroom climate and increase learners’ motivational levels (Goertler, 2009). Facebook can also expand learning beyond a traditional classroom into informal learning settings (Bull et al., 2008; Yang, Wang, Woo, & Quek, 2011).

In terms of social media platforms used in Higher Education, Facebook has been the focus of many studies (see McGuckin and Searly, 2013; Roblyer, McDaniel, Webb, Herman, Witty, 2010 and Nykvist, Daly and Ring, 2010), though many of these studies have had quite small sample sizes. A large number of these studies have focused on supporting students or enhancing learning (often through communication strategies), hence being used in a social manner. The study by Nykvist, Daly and Ring (2010) focused on education students supporting one another as they undertook their practicum experience in Malaysian schools and once again reinforced the supportive nature of this medium. There is little doubt that social media and mobile technologies can support students, however, there is a need to better understand how pre-service education students and academics can embrace these to cater for and respond to student needs.

In an attempt to better understand the strength of these technologies and how students use them in their studies and private life, this paper will describe a study conducted over a three year

period. Although this study is still underway, we are able to provide some initial recommendations for future teaching and learning practices to support students in their first year experience through the use of these technologies.

2. Methods

A mixed methods approach was adopted for this research. Using Creswell and Plano Clark's (2011) definition and core characteristics (p.7), the study combines 'methods, a philosophy and a research design orientation'. During the research, data was collected and analysed using both qualitative and quantitative methods. A qualitative case study methodology based on Yin's (2003) model for exploratory case study using multiple sources of evidence was applied in this study. The study was designed to understand how students entering a pre-service teacher education program used mobile devices and social media and the possible impact that these technologies had on student retention and student first year experiences. It also explored how academics, teaching first year students, used social media and mobile technologies in their academic and personal lives, while drawing upon the experiences of students and staff in an attempt to identify the role these technologies play in teaching and learning.

The data was collected over a course of three years from each new cohort of first year pre-service teachers (N=1472) from the teaching areas of Early Childhood, Primary and Secondary Education. The study employed a "wide range of interconnected interpretive practices" (Denzin & Lincoln, 2000, p.3) to identify the use of mobile devices and social media technologies by students and staff through a range of surveys, interviews and focus groups to elucidate rich and meaningful data for analysis. Students were asked to voluntarily complete an online survey at the beginning of the semester and a follow up online survey at the end of the semester. In the most recent year of data collection this survey was extended to academics teaching in first year units, and semi-structured interviews and focus groups were conducted with students and their teachers throughout the semester and at the end of the teaching period.

3. Findings and Discussion

The findings discussed here are based on data collected from each of the initial surveys that were conducted over the three years of the study (2012 – 2014). Each new cohort of students completed the survey at the beginning of their first semester in their first year with an adapted survey given to staff teaching into the first year units in 2014. Each of the surveys had a high response rate, with a response rate of over 80% for each of the years. Over 70% of respondents in each of the surveys were female, which is in line with the higher number of female students enrolled in pre-service teaching degrees. The age profile of first year Faculty of Education student respondents showed a majority were aged 15-22, with 62% in the 18 – 22 years age range and 22% in the 15 – 17 years age range.

The data from the student survey indicates that there was a strong use of social media tools by the students in each of the years with Facebook being the most popular social media technology with an increase from 84% usage by students in 2012 to a usage of 86% in 2014. Other social media technologies such as Instagram, Twitter and Tumblr also showed similar trends with minor growths in usage by the students with the respective usage of each platform in 2014 being 53%, 18% and 6% of students. While Twitter has remained quite low over the three year period the application Snapchat went from a 13% usage in 2013 to a 45% usage in 2014. Email still remained the most popular tool for students over the 3 year period with its usage moving from 88% in 2012 to 90% in 2014.

With Facebook clearly being the most popular social media technology with first year pre-service teachers, the results contradict contemporary media reports that suggest teenagers are deserting Facebook, in favour of sites such as Twitter, Instagram and WhatsApp (Kiss, 2013). The data also indicates that students primarily use mobile technologies for email or messaging with ownership of a laptop remaining at over 90% for each of the years. This trend was not the case for other mobile technologies with the strongest growth in ownership being with the iPhone and iPad. The data indicates that ownership of the iPhone rose by 33% from 2012 to 2014 with 79% of students owning the device while the iPad had an increase of 46% from 2012 to 2014 resulting in a 56% ownership.

Staff ownership of iPads and laptop computers was also high with ownership of both being 83% and iPhone usage at 67%. The data from the staff survey also indicated that their patterns of usage of social media and mobile technologies, were similar to that of the students with Facebook being used by all staff (N=6). While one staff member reported regular usage of Twitter, no staff reported using social media technologies such as Instagram, Flickr or Snapchat where digital images are shared and/or exchanged. Hence, the range of social media technologies used by staff, was more limited than the range used by students. The age range of the staff respondents was primarily in the 40 – 49 years age category and while they felt comfortable using the social media technologies and mobile devices in their personal lives the majority were hesitant in using them in their teaching and learning. When staff were asked to comment about their use of these technologies, Staff A (2014) commented that “I feel confident, but don't think I use them that well pedagogically for teaching.”

The survey data thus indicated that students found a need to use social media technologies (SMT) and mobile devices, and that they used them regularly in their personal lives. It was within this context that students were asked about why they use social media in the 2014 survey. The responses to this are indicated in Figure 1.

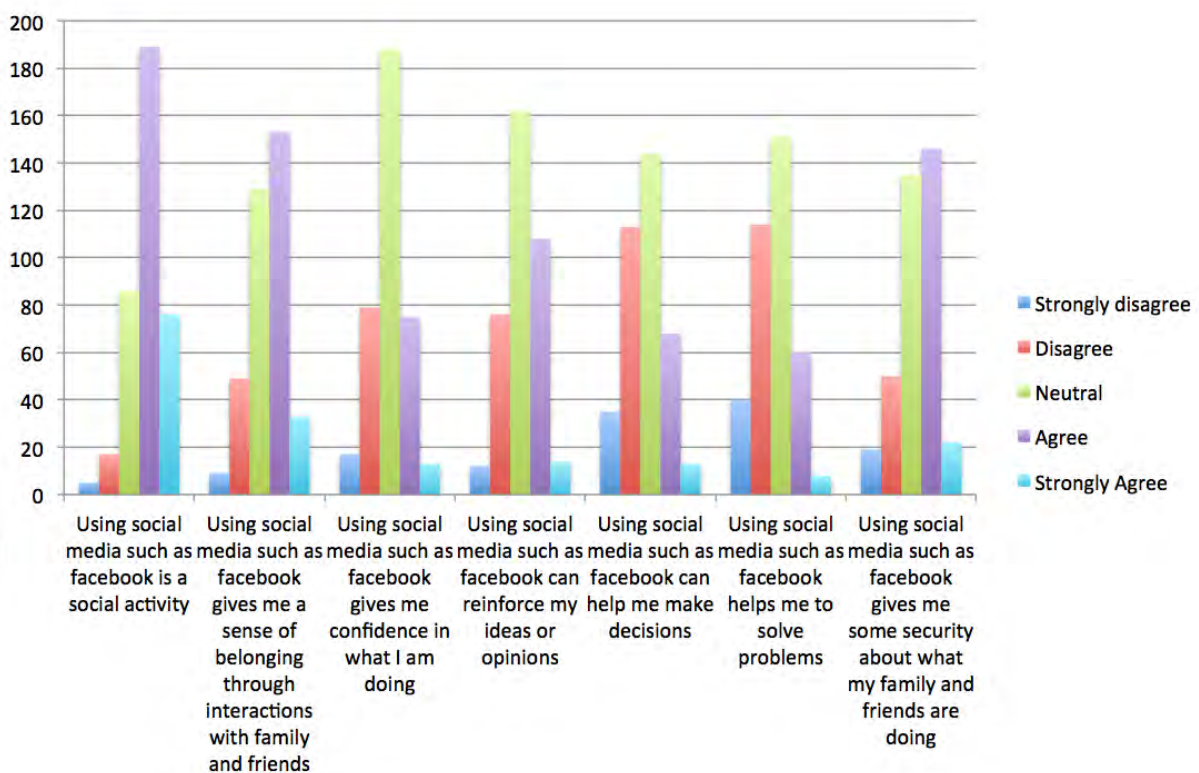

Figure 1. Student reports of the purpose of using social media in 2014

From Figure 1, it can be seen that students felt that social media gave them a sense of belonging, which has been identified in the literature as an essential component in creating a positive first year experience and consequently the retention of students. The data also indicated that social media technologies, such as Facebook, are used as a social activity, giving students security about the current state of wellbeing of friends and family. Very few students (n=68) perceived a use of social media would be suitable for problem solving, however 33% of students did indicate that social media technologies are able to reinforce ideas and opinions.

The familiarity with social media technologies felt by students and the sense of belonging that many students associate with using these technologies suggests social media technologies could be used more strategically by academics to create a sense of community and a safe place for students to express opinions and share experiences. These findings support earlier research where Facebook was identified as a means through which students could express opinion (McCarthy, 2010) and create a more comfortable classroom environment (Goertler, 2009). The research data indicates that staff are

not comfortable using social media and mobile technologies in teaching and learning and this presents problems when trying to respond to the needs of students and improve the first year experience.

4. Conclusion

While it can be argued that information and communications technologies are rapidly changing and that it is difficult for educators to keep up with these, the results of this study over a three year period indicate that there is some stability in the range of technologies adopted by pre-service education students. The results from this study indicate that students are comfortable using these technologies and that the use of social media technologies can be associated with a sense of belonging and acceptance by a large percentage of students. The most striking difference between the staff usage of the social media technologies and that of students, is in the wider sharing of digital images by students who use image sharing technologies such as Instagram, and more recently, Snapchat.

With the positive first year experience, and ultimately the retention of students, being of great importance to many Higher Education Institutions, it is critical that institutions respond to the needs of students by not just using these tools in their teaching and learning practices, but by transforming their approaches to teaching and learning to utilise these technologies in an authentic and meaningful way for students. There is a gap between how students use social media and mobile technologies and how academics use these technologies. The students feel a sense of belonging when they use these technologies and by closing this gap, there is an increased opportunity for students to feel secure and develop a sense of belonging. The mere creation of a Facebook page, or many Facebook pages, will not automatically create a sense of belonging for students, especially if it is just used for updates or the advertising of events. This paper reports on a study in progress and while early results do indicate that social media and mobile technologies can play a crucial role in the first year experience and can act as an enabler, there is a need for further research into how academics and institutions can embrace these technologies to create a sense of belonging and respond to student needs.

Reference List

- Arteaga Sánchez, R., Cortijo, V., & Javed, U. (2014). Students' perceptions of Facebook for academic purposes. *Computers & Education*, 70(0), 138-149. doi: <http://dx.doi.org/10.1016/j.compedu.2013.08.012>
- Bandura, A. (1997). *Self-efficacy: the exercise of control*. New York: W.H. Freeman.
- Bull, G., Thompson, A., Searson, M., Garofalo, J., Park, J., Young, C., & Lee, J. (2008). Connecting informal and formal learning experiences in the age of participatory media. *Contemporary Issues in Technology and Teacher Education*, 8(2), 100-107.
- Creswell, John W. & Plano Clark, Vicki L. (2011). The nature of mixed methods research. *Designing and conducting mixed methods research*. 2nd Ed., Thousand Oaks: California
- Denzin, N. K., & Lincoln, Y. S. (2005). Introduction: The discipline and practice of qualitative research. In N.K. Denzin & Y. S. Lincoln (Eds.), *The Sage handbook of qualitative research* (2nd ed.), (pp. 1-32). Thousand Oaks, CA: Sage
- Goertler, S. (2009). Using Computer-Mediated Communication (CMC) in Language Teaching. *Die Unterrichtspraxis/Teaching German*, 42(1), 74-84. doi: 10.1111/j.1756-1221.2009.00038.x
- Hoffman, M., Richmond, J., Morrow, J., & Salomone, K. (2002). Investigating "Sense of Belonging" in first year college students. *Journal of College Student Retention: Research, Theory and Practice*, 4(3), 227-256.
- James, R., Krause, K., & Jennings, C. (2010). *The First Year Experience in Australian Universities: Findings from 1994 to 2009*. Centre for the Study of Higher Education, The University of Melbourne. Retrieved from http://www.cshe.unimelb.edu.au/research/experience/docs/FYE_Report_1994_to_2009.pdf
- Jensen, U. (2011). Factors Influencing Student Retention in Higher Education, *Kamehameha Schools Research & Evaluation*. Retrieved from http://www.ksbe.edu/spi/pdfs/retention_brief.pdf
- Khalil, H. & Ebner, M. (2013). "How satisfied are you with your MOOC?" - A Research Study on Interaction in Huge Online Courses. *Proceedings of World Conference on Educational Multimedia, Hypermedia and Telecommunications*, Jun 24, 2013, Victoria: Canada
- Kiss, J. (2013, December 27). Teenagers migrate from Facebook as parents send them friend requests, *The Guardian*. Retrieved from <http://www.theguardian.com/technology/2013/dec/27/facebook-dead-and-buried-to-teens-research-finds>

- McCarthy, J. (2010). Blended learning environments: Using social networking sites to enhance the first year experience. *Australasian Journal of Educational Technology*, 26(6), 729-740.
- McGucking, T. & Sealey, R. (2013). Integrating Facebook into a University cohort to enhance student sense of belonging: a pilot program in Sport and Exercise Science. *Australian Educational Computing*, 2013, 28(1).
- Menzies, V. J., & Nelson, K. J. (2012). *Enhancing student success and retention : an institution-wide strategy for peer programs*.
- Micari, M., & Drane, D. (2011). Intimidation in small learning groups: The roles of social-comparison concern, comfort, and individual characteristics in student academic outcomes. *Active Learning in Higher Education*, 12(3), 175-187. doi: 10.1177/1469787411415078
- Napoli, A. R. & Wortman, P. M. (1998). Psychosocial factors related to retention and early departure of two-year community college students. *Research in Higher Education*, 39(4), 419-462.
- Nelson, K. J., Quinn, C., Marrington, A., & Clarke, J. A. (2012). Good practice for enhancing the engagement and success of commencing students. *Higher Education*, 63(1), 83-96. doi: 10.1007/s10734-011-9426-y
- Nykvist, Shaun S., Daly, Craig B., & Ring, Jared W. (2010) Everyone wants Web 2.0. In Proceedings of the 18th International Conference on Computers in Education, *Asia-Pacific Society for Computers in Education* (APSCE), Putrajaya Marriott Hotel, Putrajaya, Malaysia.
- Roblyer, M., McDaniel, M., Webb, M., Herman, J. & Witty, J. (2010). Findings on Facebook in higher education: A comparison of college faculty and student uses and perceptions of social networking sites. *Internet and Higher Education*, 13(2010), 134–140.
- Underwood, J., Underwood, G., & Wood, D. (2000). When does gender matter? *Learning and Instruction*, 10(5), 447-462. doi: 10.1016/S0959-4752(00)00008-6
- Wilcox, P., Winn, S., & Fyvie-Gauld M. (2005). It was nothing to do with the university, it was just the people': the role of social support in the first year experience of higher education. *Studies in Higher Education*, 30(6), 707-722.
- Wilkinson, I. A. G., & Fung, I. Y. Y. (2002). Small-group composition and peer effects. *International Journal of Educational Research*, 37(5), 425-447. doi: 10.1016/S0883-0355(03)00014-4
- Yang, Y., Wang, Q., Woo, H. L., & Quek, C. L. (2011). Using Facebook for teaching and learning: a review of the literature. *International Journal of Continuing Engineering Education and Life Long Learning*, 21(1), 72-86.
- Yin, R. K. (2003). *Case study research: Design and methods*. Thousand Oaks, London, New Delhi: Sage Publications

Implementing and Validating a Mobile Learning Scenario Using Contextualized Learning Objects

Alisa SOTSENKO^a, Marc JANSEN^{ab}, Marcelo MILRAD^a

^a*Media Technology, Linnaeus University, Växjö, Sweden*

^b*Computer Science, University of Applied Sciences Ruhr Wes, Bottrop, Germany*

alisa.sotsenko@lnu.se

marc.jansen@lnu.se, marc.jansen@hs-ruhrwest.de

marcelo.milrad@lnu.se

Abstract: Substantial research in the field of mobile learning has explored aspects related to contextualized learning scenarios. Nevertheless, the current context of a mobile learner has been often limited to his/her current position, neglecting the possibilities offered by modern mobile devices of providing a much richer representation of the current learner's context. In this paper, we show that a detailed contextualization of the learner may provide benefits in mobile learning scenarios. In order to validate this claim, we implemented a mobile learning scenario based on an approach that allows for a very rich and detailed contextualization of the mobile learner. The scenario that we implemented allowed exchange students to be guided at Linnaeus University in Växjö, Sweden in order to get familiar with the campus and prominent institutions on it. We carried out a study including two groups; one that performed learning activities with contextualization support and one other without it. The results of our evaluation showed significantly better results for the contextualized approach, especially with respect to the acceptance of the Perceived Ease of Use.

Keywords: mobile learning scenarios; learning objects; contextualization; cross-platform development

1. Introduction

With the growing population of mobile devices, especially smartphones and tablet PCs', also their usage in mobile learning scenarios increased tremendously. A significant amount of research has been conducted in recent years, providing both, new technological approaches and pedagogical scenarios to support learning. According to O'Malley et al., (2003) mobile learning can be defined as "any kind of learning when the learner is not at a static or fixed location, or when the learner takes advantage of mobile technologies". For the purpose of this study, we understand mobile learning as learning that occurs outside of a traditional classroom and when the learner uses a mobile device in order to perform some tasks in the context of the learning activity. The context of the learner may include different contextual information about the environment, device, user's needs and interests. Mobile learning scenarios that take into account the learning context are called contextual mobile learning (Chuantao, Bertrand, & Rene, 2009). The mobile device allows collecting user's current context information, e.g., by collecting data from various sensors, to provide a convenient and easy way of learning independent of time and space (anywhere and anytime).

In order to investigate whether a richer contextualization model, as described in (Sotsenko, Jansen & Milrad, 2013a; Sotsenko, Jansen & Milrad, 2013b) really provides benefits to mobile learning scenarios, we developed a guided tour activity at our university, both with and without contextualization support. The objective of this study was to understand if the implementation including contextualization support provides significant differences with regard to an implementation without that support. The results of these efforts are described in this contribution.

The rest of the paper is organised as follows: next section provides a short overview about the current state of the art. Afterwards, a description of the implementation of our scenario is provided,

followed by the presentation of the results of our evaluation. In the last section, we conclude by discussing our results and providing some ideas for future lines of research.

2. State of the art

The experiment carried out by Hung et al., (2014) shows that using multimedia content of Learning Objects (LO) is more convenient and satisfactorily than just LOs in textual form. Approaches utilizing multimedia LOs can be used in mobile learning scenarios, e.g., for data collection in science education (Vogel, 2013), for quizzes with access to learning content (Geisler & Jansen, 2011) and/or field trips (Giemza A. , Bollen, Jansen, & Hoppe, 2013). in which mobile devices assist the learners in a convenient and efficient way. For instance, Wang et al., (2012) have developed a context-aware mobile application for navigating university campus maps in which personalized maps show important and relevant buildings, e.g., providing services to students. The results of this experiment indicate that a contextualized approach could improve its usefulness and navigation efficiency. Unfortunately, in this research contextual support only consisted of GPS location information and the user needed to specify the type of buildings/services he/she have been interested in. Moreover, no indoor navigation support was provided and the application was implemented only for the iOS platform. Another multimedia based mobile application is the Mytilene E-guide (Kenteris & Economou, 2011), implemented as a tourist guide allowing users to select certain content and to download an application for an appropriate mobile platform. The advantage of this app is its ability to also work in an offline mode while, at the same time; a disadvantage is that it was not implemented as a cross-platform application. In the work discussed in this paper, we present a cross-platform mobile app with contextualization support for which a much richer context model was used not just relying on the current user's location. The scenario that we implemented allowed exchange students to be guided at the Linnaeus University (LNU) in Växjö, Sweden in order to get familiar with the campus and prominent institutions on it. Therefore, the app provides relevant information about the university, its campus, cafes and other facilities. Here, the mobile app provides different activities, subdivided in to different tasks that allow foreign exchange students to get familiar with their new university.

3. Implementation

This section describes the implementation of a mobile application utilizing the contextualization approach described in (Sotsenko, Jansen, & Milrad, 2013a), implementing a three dimensional (environment, device and personal context) vector space model in which LOs' are represented. The context data is collected by: a) accelerometer, to define the movement (e.g. moving, sitting/standing) of the user; b) GPS location, to define the current place by using Google Places API; c) GPS location, to define the current weather condition; d) battery service, to define the battery status; e) screen size (width, height); f) camera, to confirm user location by scanning QR codes (e.g., for indoor navigation); and g) the user profile in a corresponding Learning Management System (LMS), to define users with similar interests. All LOs' to be used are stored in different media formats (.pdf, .html, .mp3, .mp4) in a standard LMS (Moodle) in order to make them accessible to the app.

The implementation of the app was done in a platform independent way (Sotsenko, Jansen, & Milrad, 2013b), for allowing a cross-platform deployment. The server-side implementation was done in Node JS for the main functionality of the mobile app. The client side is implemented by using the jQuery Mobile framework, allowing for the creation of user-friendly mobile interfaces. For persistency, a MongoDB database was used in order to natively store JSON objects, used for the complete communication in the system. Additionally, to collect the information about the current context of the user we used additional Web Services: a) Free Weather API provides the current weather condition for the location of the user; b) Google Places API provides the information (e.g. name, type, image, etc.) of current place of the user. These two types of data have been necessary in order to provide an appropriate description in the rich context model; c) Moodle Web Service extension (Piguillem, et al., 2012) allowing access to the LOs' that we provided to users as main learning content in the app; and d) a QR code service used for reading QR codes in order to identify the current location of the user in an indoor scenario.

3.1 Description of LnuGuide mobile application

The following sub-section describes the main functionality of the LnuGuide mobile app. At the login view, the user should login with a username and password from the LMS. The main view (Figure 1) is responsible for helping users to navigate in the activities. The Google Maps API v3 along with the Google Places API are used in order to provide an easy and convenient navigation. For inside navigation, the QR code service was used in order to determine the current position of the user.

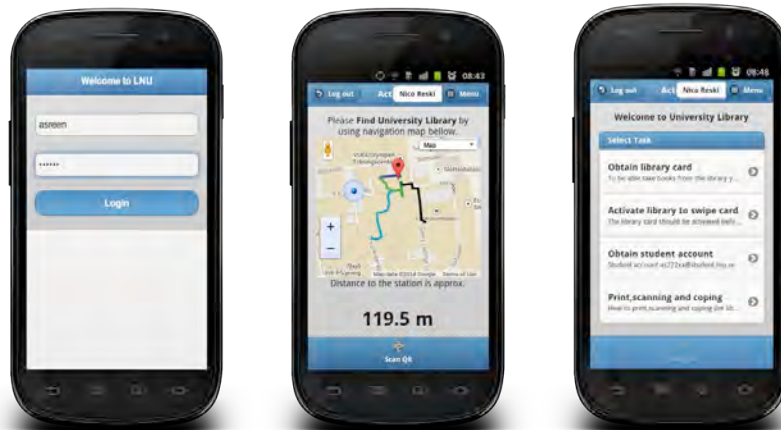

Figure 1. Screenshots of *login* and *main* view in LnuGuide app

The activity lists the tasks that a user can choose within his/her current station. Based on the user's current location the application will provide different tasks that are retrieved from a database. The task view shows the learning material in an appropriate format, according to the current context of the user. The profile view allows filling and saving the users' profile, e.g., with data like a picture by taking a photo, the study program of the learner, interests and hobbies. In order to facilitate collaboration between students the real-time chat is provided by application. The application determines other users with similar interests that are of the database and applies a filter to just show which users are currently online.

3.2 Description of the Learning Scenario

Mobile learning scenarios can be designed for guiding mobile learners to gain information about their current learning environment and how to work in it. For instance, students can learn about how to use the different services at the university library (e.g. registration in the library, usage library card, etc.) if he/she is inside the university library. Another example might be that students can be guided to learn how to print and scan papers by using universities printing system. The scenario described in this paper was designed for allowing international exchange students to familiarise with LNU and to learn about the different facilities and services available on campus. The Student Guide activity contains three stations (e.g. University Library, Administration Building and a café on campus) where students can get useful information to facilitate his/her "student life" (e.g. obtain the library or student card, to be able scan and print at Library, etc.). Each station provides a number of tasks, where, e.g., the app will provide information on how to scan documents at the library including instructions that the user should easily be able to perform. In this scenario, the LOs represent learning materials describing certain tasks that need to be carried out by the students.

4. Evaluation

An evaluation was performed to address the following research question: does the contextualized version of the LnuGuide provide benefits compared to the implementation of the LnuGuide app without contextualization support? In order to investigate this, we carried out a study including two groups of students; one group performed the scenario with contextualization support (Group№1) and a control group without contextualization support (Group№2).

4.1 Participants

The participants of the study were 25 exchange master students arriving to LNU on January 17th 2014 and invited via a Facebook event to participate in the Student Guide Activity during the universities' orientation week. The participants were divided into two groups where the Group№1 had fourteenth students and Group№2 eleven students.

4.2 Description of Study

The participants were enrolled in the course in our Moodle system manually with username and password. Before the Student Guide Activity started, a Samsung Galaxy S3 mobile device with the installed LnuGuide app and headphones has been provided to each one of the participants.

The Group№1 with contextualization support performed the different tasks of the activity in 45 min.. Below, we provide a short example of the type of contextualization support provided by the app. For example, the task "How to use the library card in order to be able to gain access to computer facilities at the university and enter universities buildings at any time?" Considering the current context of the user: user is walking near the university library and the weather condition is cloudy with the temperature -4C and his/her mobile device charged with 90% and with 3G connection. The learning material would be provided in audio format because light conditions are too bad for video and during movement it is probably not convenient to consume a text-based format. Considering a different context of the user: user is standing inside the university library and his/her mobile device charged with 40% and with Wi-Fi connection, the learning material would be presented in text format due to the low battery load, the different lightning conditions and the user not moving.

The Group№2 without contextualization support performed the activity also in 45 min. Here, different tasks provided the material only in text format and without taking into account the current context of the user. After the activity finished, participants from both groups were provided with the questionnaires including additional open feedback text questions.

4.3 Limitations

According to a previously performed pilot test with a few students, we defined that 45 min should enough to complete all tasks that were part of the university guide scenario. Still, in our final study, the external students complained that 45 min was not enough to perform all tasks. The overall number of students ($N=25$) resulted from the fact that we implemented the first prototype of the LnuGuide application in order to validate our approach, test and improve the application before running a larger study. At the end, the different number of students in the groups did not significantly influence the results of the quantitative analysis.

4.4 Study Results

The evaluation was conducted using questionnaires according to the Davis' Technology Acceptance Model (TAM) (Davis, Bagozzi, & Warshaw, 1989). From this set of questionnaires, we haven chosen two that fit well with our aims: the Perceived Usefulness (PU) and the Perceived Easy of Use (PEU). A seven-point likert scale (Likert, 1932) was applied for each question. The questions have been adapted (Giemza A. , Bollen, Jansen, & Hoppe, 2013) to our study. In order to determine whether or not the increased contextualization support provides some statistically relevant improvement, we deeply analyzed the gathered data from the questionnaires. First of all, we calculated the total average for the Perceived Usefulness to 4.83 in Group№1 and 4.69 in Group№2. For the Perceived Ease of Use the total average is 5.03 for Group№1 and 4.2 for Group№2. In order to test these results for significance, we conducted an independent-samples t-test for the PU and for the PEU. The results for PU indicate a not significant difference with regard to the total scores in Group№2. Still, the results for PEU show differences in question 2.2, 2.5 and 2.6 regarding the total scores in Group№2. So, we decided to conduct a t-test comparing the mean scores of questions 2.2, 2.5 and 2.6 in Group№1 and Group№2. Since we had a relatively small group of participants ($N=25$), we decided to calculate the

effect size offered by (Cohen, 1988). This test shows a significant difference in the question 2.5 ($M=2.79, SD=1.67$) for Group№1 and ($M=4.82, SD=2.32$) for Group№2; $t(13)=4.55, p=0.001, d=1.0$. In the question 2.6 ($M=3.15, SD=1.7$) for Group№1 significantly less then ($M=4.63, SD=2.1$) in Group№2; $t(13)=3.29, p=0.006, d=0.7$. Results for question 2.2 indicates non-significant difference for Group№1 ($M=3.57, SD=1.5$) and ($M=4.63, SD=2.01$) for Group№2; $t(13)=1.73, p=0.106, d=0.59$. All statistical tests have been conducted with an alpha level of 0.01.

4.5 Discussion of Results

The results for the Perceived Usefulness show almost no difference between the two groups, which is not surprising since the scenario and the provided learning content was the same for both groups. Figure 2, shows the average values both for the group using the contextualization approach (Group№1) and the control group (Group№2). From the t-test results we found that there are not significant differences for question 2.2. Furthermore, the corresponding Cohen's effect size (Morgan, 2002) value ($d = .59$) suggests a high significance. Still, significant differences could be found in question 2.5 indicating that using the LnuGuide mobile app with contextualized approach is less exhausting than the LnuGuide mobile app without contextualization. Here, the corresponding Cohen's effect size value ($d = 1.0$) also suggests a high significance. Furthermore, the results from question 2.6 show that with rich contextualization support, it was easier for the students to remember how to perform certain tasks within the provided scenario. Last but not least, here, the corresponding Cohen's effect size value ($d = 0.7$) suggested medium significance. Therefore, it could be said that the implementation based on the rich contextualization support is easier to use.

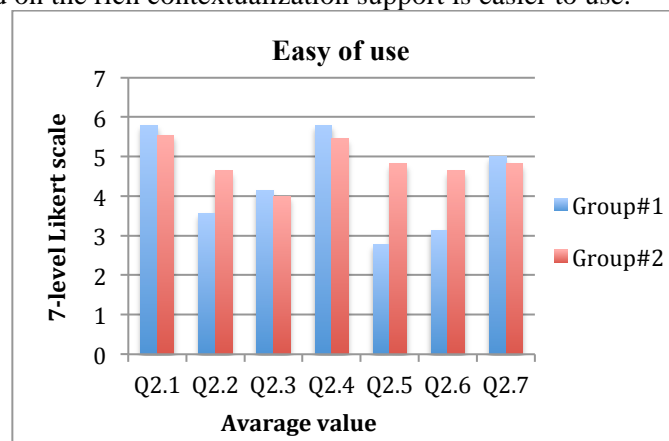

Figure 2. Average rating for PEU questionnaire

5. Conclusions and Future Work

The mobile learning scenario to guide exchange students at Linnaeus University was designed to identify the possible benefits of a rich contextualization support in a mobile learning scenario. The cross-platform LnuGuide mobile application was developed using jQuery Mobile, Node JS and Web Services, providing a stable and reliable technology stack for the development of cross-platform apps. Positive comments and feedback from the students showed that the LnuGuide app with contextualization support is more convenient to use and beneficial in order to achieve their goals (or to perform the tasks) easily. The evaluation also showed significantly better results for the contextualized approach, especially with respect to the acceptance of the Perceived Ease of Use. The results of the study provide some new insights with regard to the usage of the multi dimensional vector space model for modeling user's context for a mobile context based recommender system. The contextualization allows adaptation of the LO's format and the delivery of the LO's to mobile devices according to the user's context in order to keep learner's concentration and convenient study in anywhere and anytime. Our next research steps include a modification of the contextualization support to expand it to mobile health scenarios, where the usage of contextual information provided an important opportunity to create new personalized mobile healthcare applications. Additionally, we

plan to refine our approach on how to provide LOs' in different multimedia formats and to further improve the contextualization mechanisms.

References

- Chuantao, Y., Bertrand, D., & Rene, C. (2009). Use your mobile computing devices to learn-Contextual mobile learning system design and case studies. *Computer Science and Information Technology 2nd IEEE International Conference*, Beijing , 440-444.
- Cohen, J. (1988). *Statistical power analysis for the behavioral sciences* (2nd ed.). New Jersey.
- Davis, F. D., Bagozzi, R., & Warshaw, P. R. (1989). User acceptance of computer technology: a comparison of two theoretical models. *Management Science* , 35, 982-1003.
- Florence, M., & Ertzberger, J. (2013). Here and now mobile learning: An experimental study on the use of mobile technology. *Computers & Education* (68), 76-85.
- Geisler, S., & Jansen, M. (2011). Getting Serious About a Platform Independent Application for the Usage of Mobile Moodle Quizzes: A Case Study. *DeLFI Workshop* .
- Giemza, A., Bollen, L., Jansen, M., & Hoppe, H. U. (2013). A flexible unified architecture to support heterogeneous multi-device learning environments. *Int. J. of Mobile Learning and Organisation* , 7 (3/4), 210-223.
- Giemza, A., Bollen, L., Seydel, P., Overhagen, A., & Hoppe, H. (2010). LEMONADE: A Flexible Authoring Tool for Integrated Mobile Learning Scenarios. *6th IEEE International Conference Wireless, Mobile and Ubiquitous Technologies in Education*, 73-80.
- Hung, I.C., Yang, X.J., Fang, W.C., Hwang, G.J., & Chen, N.S. (2014). A context-aware video prompt approach to improving students' in-field reflection levels. *Computers & Educations* , 70(1), 80-91.
- Kenteris, G., & Economou, D. (2011). Mytilene E-guide: a multiplatform mobile application tourist guide exemplar. *Multimedia Tools and Applications* , 54 (2), 241-262.
- Milrad, Marcelo; Wong, Lung-Hsiang; Sharples, Mike ; Hwang, Gwo-Jen; Looi, Chee-Kit and Ogata, Hiroaki (2013). Seamless learning: an international perspective on next-generation technology-enhanced learning. In: Berge, Zane L. and Muilenburg, Lin Y. eds. *Handbook of Mobile Learning*. Abingdon: Routledge, pp. 95–108
- Morgan, S. E., Reichert, T., & Harrison, T. R. (2002). *From numbers to words: Reporting statistical results for the social sciences*. Allyn and Bacon.
- Likert, R. (1932). A technique for the measurement of attitudes. *Archives of Psychology* , 140, 1-55.
- O'Malley, C., Vavoula, G., Glew, J., Taylor, J., Sharples, M., & Lefrere, P. (2003). *MOBlearn WP4-Guidelines for learning/teaching/tutoring in a mobile environment*. -: MOBlearn/UoN.
- Piguillem, J., Alier, M., Casany, M. J., Mayol, E., Galanis, N., García Peñalvo, F. J., et al. (2012). Moodbile: a Moodle web services extension for mobile applications. *1th Moodle Research Conference*, Heraklion, 148-156 .
- Sotsenko, A., Jansen, M., & Milrad, M. (2013a). About the Contextualization of Learning Objects in Mobile Learning Scenario. *mLearn*, 11, Qatar, 67-70.
- Sotsenko, A., Jansen, M., & Milrad, M. (2013b). Supporting Content Contextualization in Web Based Applications. *9th International Conference on Web Information Systems and Technologies*, Aachen, 501-504.
- Vogel, B. (2013). Towards open architecture system. 9th Joint Meeting on Foundations of Software Engineering. New York, 731-734.
- Wang, T. S.-H., Tjondronegoro, D. W., Docherty, M., & Song, W. (2012). Uninav : a context-aware mobile application for university campus maps. *Internet of Things Workshop*.

Learning Log Dashboard: to see your own progress

Erdenesaikhan LKHAGVASUREN^a, Kenji MATSUURA^{a*}, Kousuke MOURI^b and Hiroaki OGATA^b

^a*Tokushima University, Japan*

^b*Kyushu University, Japan*

*ma2@tokushima-u.ac.jp

Abstract: This paper proposes a learning log dashboard interface design issues for a mobile learning system called SCROLL (System for Capturing and Reusing Ubiquitous Learning Log). SCROLL allows learners to record and share their daily learning experiences as ULL (ubiquitous learning logs) with locations, photos, words, sentences and/or videos using their smartphones. Moreover SCROLL provides quiz that are generated from ULL so that they can remember past learning experiences. Learners add many words, photos on their account and always repeat this action, like as continuous training. It will be sometimes happened forgetting quiz even works on those words in the past. The overall goal of this learning log dashboard is to enable learners to reflect on their own activity, to reinforce what they have learned and to learn from each other. Learners also can see the information about her/his progress on learning log dashboard.

Keyword: Learning log dashboard, ubiquitous technology, language learning, memory

1. Introduction

In today's world a great revolution is occurring in the mobile device with the release of new generation smartphones represented by iPhone and Android. The new generation smartphones accommodate learners with many advanced functions such as the multi-touch interface, virtual keyboard, GPS navigation, a full browser and record notes. It allows learners for immediate access to data online wherever one is at home, travelling or at work. One key feature of smartphones is that they are equipped with a range of sensors such as the accelerometer, GPS, compass and so on. Using such functions of smartphones, SCROLL (System for Capturing and Reusing Ubiquitous Learning Log) has been developed originally (Ogata et al., 2011).

SCROLL is a system to assist learners to simply capture, review and reflect their learning logs, reuse the knowledge when it is needed. It adopts an approach of sharing learner-created contents among learners. It means that a learner's learning log cannot merely available for her/him, but also can be shared with other learners who have the same learning needs.

The term "learning log" is originally used for personalized learning resources for children (Wikipedia, n.d). In this study, learning log is defined as a recorded form of knowledge or learning experience acquired in our daily lives. It serves as memory storage for notable or important knowledge to review, to remind and to reflect. For example, a learning log can be a Japanese word or a piece of English sentence taken down by a language learner.

The target learners of SCROLL are overseas students who study Japanese language in Japan. It is because they acquire lots of knowledge from their daily lives, for example, when they go to a post office, shopping in a market or seeing a doctor in the hospital. Such a learning activity is a kind of episodic memory (Tulving et al., 1973) for the learner for which it can help the students to remember the knowledge for a long term (Tulving et al., 1973). Butler and his colleagues find that testing can also improve long-term retention and the strategy of repeated testing enhances learning more than repeated reading (Butler et al., 2007).

Learners' vocabularies increase highly by learning many new words everyday and by sharing them with others. In order to help learners to see their own progress and reflect information they add, we

propose the function "Learning log dashboard" (L2D). L2D uses the log of learners in SCROLL to enable learners to reflect on their own activity and recall what they have learned. The dashboard also enables learners to see their own progress at a glance. For example: updates, success, statistics, information and how many logs they need practice. Thus, a learner will repeatedly practice words by the quizzes in order to avoid from repetitive mistakes, and eventually s/he will be greatly motivated.

Therefore L2D will give learners an easy way to find the best next things to do and increase motivation of them. This paper is organized as follows: in the next section we present L2D. Future work and conclusion are presented in section 3.

2. Learning Log Dashboard

Learning Log Dashboard (L2D) is a function of SCROLL, which is to enable learners to reflect on their own activity and to see their own progress. L2D focuses on statistical data on every learner's usage of the system. L2D shows the number of learning logs that a learner uploaded and the number of completed quizzes, as well as memorized learning logs and incorrect answers of the quizzes. It is easy to see incorrect answers on a word and to control in the dashboard.

Learners can distinguish each learning log, which is differently represented in several colors. Last results are presented in scores distinguished in colors: if a learner answers incorrectly for the first time the learning logs are marked in **green**, for the second time the learning log color turns **yellow**. If an incorrect answer is repeated for the third time, the color becomes **red** in turn (Figure 1). It means that learners have to deeply concentrate on their mistakes and use incorrect answers in practice. If a new learner has not added a log to the system yet, L2D is blank. Figure 2 shows a workflow of L2D. Explanation of figure 2 :

1. First, learners need to register themselves to SCROLL system. Learners can work on quizzes. Initial logs are learner's learning log.
2. When a learner finishes working on the quiz, the incorrect answers are marked in green and stored in the L2D. Correct answers will be saved in memorized logs.
3. The next time if the learner repeatedly answers incorrectly while reworking on the same quiz, the answered learning logs shall be marked in yellow. If the learner makes mistakes on the same word 3 or more times, such word shall be marked in red color.
4. If the learner completes the quiz successfully without any making mistakes on the same words s/he previously answered incorrectly, then color of the logs will be changed back. For example, if the learner correctly answers the same words 3 times, the color of the logs will continue to change until they move to memorized logs. After finishing a quiz the L2D will automatically update the information.
5. Memorized learning logs consist of memory of learner's last quiz and s/he can see it at least 100 last words. Moreover it will be easy to see updates, simple to work on it.
6. The recommended learning logs (Figure 3) are summarized on the display which shows the incorrect and correct answers of learner's past works. According Pimsleur's proposal (Pimsleur 1967) of memory schedule, which defines the length of recall interval, it is 5 times of the previous interval's length. He also discovered tenth recall of a word of second language that will not take place until 113 days or more than four months later. That one should hold the learner for well over a year. According to the memory schedule after three months, learning logs will be reappearing previous learning logs to a learner for reinforcement in recommended logs. Learners also can examine themselves by practicing the quizzes in recommended learning logs. If a learner answered correctly to the quiz, the learning log disappears from the dashboard.

Learners usually repeat mistakes on one word even if they worked quiz previously. Learners especially who are studying Japanese letters and characters should practice more to memorize. Figure 1 shows the information of learning logs that a learner answers the questions incorrectly (once twice, or more than 3 times). Learners are also able to see their progress and achievements. Then they are able to concentrate on the words answered incorrectly. If a learner clicks on the "Enjoy the quiz" button in green color, the dashboard system will automatically provide a set of quiz (Figure 4). The set of quiz contains learning logs of a learner who answered incorrectly once. According to the colors of the buttons a learner can work on quizzes. For example: red color button provides the set of quiz that

contains learning logs of a learner who answered incorrectly 3 or more times. If the learner skips the set of quiz without completing it, the dashboard will remind her/him about the necessity of completion of the task via a message to encourage her/him to study. A learner eventually will know all of the words by heart.

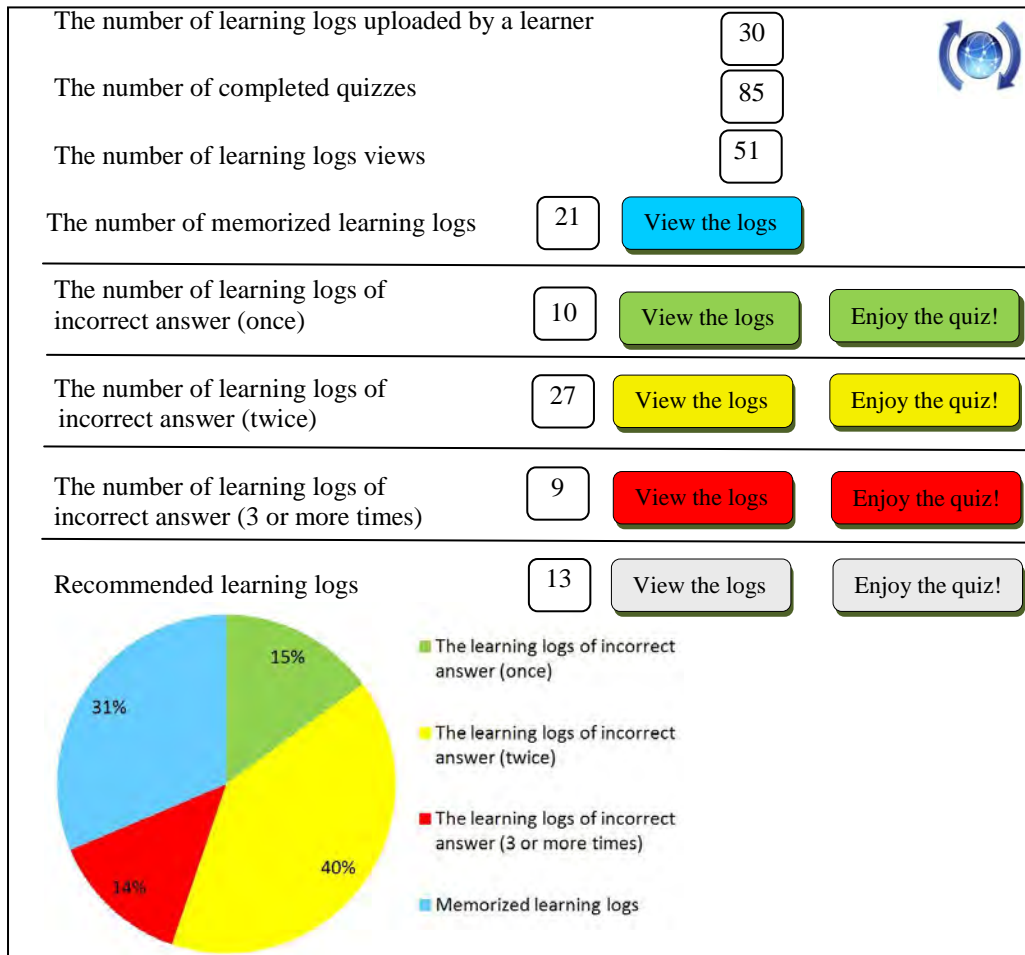

Figure 1. The image of the designed L2D

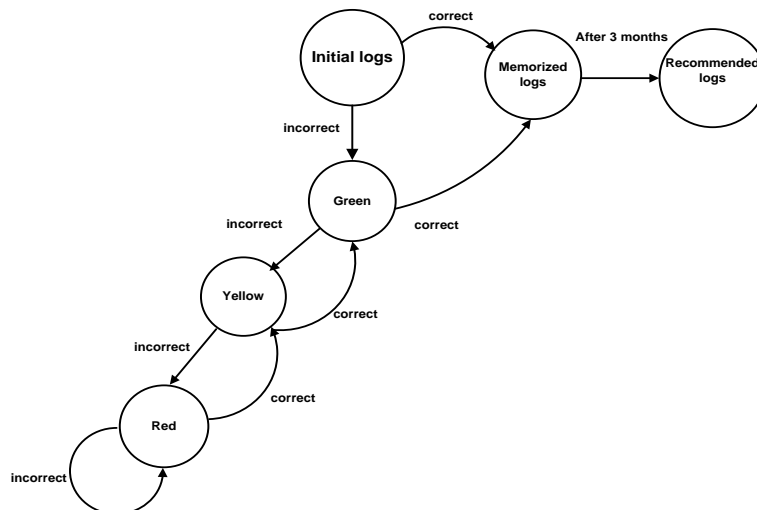

Figure 2. Workflow of the learning log dashboard



Enjoy the quiz!

Figure 3. Recommended logs

The dashboard presents a table that indicates the quiz overview of each learner. Figure 4 shows the information of learning logs of a learner who answered incorrectly once. If the learner successfully performs the quiz, then the learning logs of correct answers will move to the memorized section.



Enjoy the quiz!

Figure 4. The information of the learning logs of incorrect answer (once)

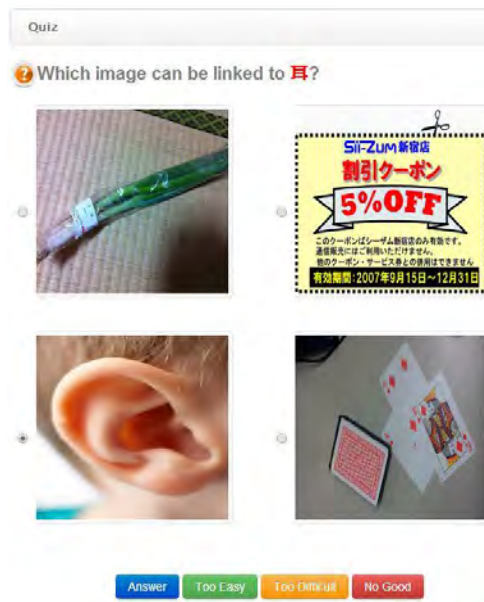

Figure 5. Actual quiz of SCROLL

Basic research on human learning ability and memory has shown that practice of information retrieval (information testing) has powerful effects on learning process and long term retention of information in human memory (Karpicke et al., 2009).

The quiz function of the system (Li et al., 2011) is based on the following two theories: the theory of encoding specificity (Tulving et al., 1973) and the theory of test-enhanced (Karpicke et al., 2009) learning. According to the former theory, a number of factors including the place where we obtained knowledge or we took photos can be encoded as initial retrieval cues. The initial retrieval cues are very effective for activation of stored memory (Tulving et al., 1973). Regular testing enhances learning process more than repeated reading. Because repeated reading often confers limited benefit beyond that gained from the initial reading of the material. (Karpicke et al., 2009).

Three types of quizzes can be generated automatically by the system: including yes/no quiz, text-based multiple-choice quiz and image-added multiple-choice quiz (Figure 5). These quizzes are interesting and attractive method for learning. For example, “quiz with image” is designed to ask learners to choose a word in order to describe images given by the system. The system immediately checks whether the answer provided by the learner is correct or not (Ogata et al., 2011).

With the learning of a new word, the process of forgetting begins at the same time once and proceeds very rapidly. If a learner remembers the word until s/he completely forgets it, her/his memory potential shall be increased.

3. Conclusion and Future work

This paper aimed to describe issues on Learning Log Dashboard System interface design in SCROLL. Learners can add their words into the system, which is designed to recall memory of students (especially who are learning foreign languages) based on their learning contexts. Learners can examine and make self-assessment by practicing the quizzes. It is common, when learners repeat the same mistake even though they repeatedly work on the quiz. Those especially who are studying Japanese letters and characters should practice such quizzes more often to improve their memory capacity. Learners can see their own progress as well as control their activity from the dashboard. A learner shall be aware of common mistakes, too.

Learner's eventual interest in dashboard focuses on its role in primary meaning of word and usage, word-board. Incorrect answers, the repeated mistakes of a learner are also important for a learner because s/he does not make mistakes anymore on that word. It is a good promotion and a big opportunity for a learner to know what is her/his incorrect answers and learn everywhere and anytime.

It is essential in the future to conduct in-depth researchers and experiments on evaluation of L2D's efficiency. How does it help the learner in their tasks?, How much does it help?, Do learners find the effort needed to use the system worthwhile in regards to the impact on their learning?.

References

- Butler, A. C., & Roediger III, H. L. (2007). Testing improves long-term retention in a simulated classroom setting. *European Journal of Cognitive Psychology*, 19(4/5), 514–527.
- Karpicke, J.D., Butler, A.C., & Roediger III, H. L., (2009) Metacognitive strategies in student learning: Do students practice retrieval when they study on their own. *Memory*, 17(4), 471–479.
- Li, M., Ogata, H., Bin, H., Uosaki, N., & Yano, Y. (2011). Personalization and Context awareness Supporting Ubiquitous Learning Log System. *In Proceedings of the 19th International Conference on Computers in Education (ICCE 2011)*, 391-395.
- Learning log*. Wikipedia. (n.d.). Retrieved 16:13:18, from http://en.wikipedia.org/wiki/Learning_log.
- Ogata, H., Li, M., Bin, H., Uosaki, N., El-Bishouty, M. M., & Yano, Y. (2011). SCROLL: Supporting to share and reuse ubiquitous learning log in the context of language learning. *Research and Practice on Technology Enhanced Learning*, 6(2), 69–82.
- Pimsleur, P. (1967). A memory schedule. *The Modern Language Journal*, 51(2), 73–75.
- Tulving, E., & Thomson, D.M. (1973). Encoding specificity and retrieval processes in episodic memory. *Psychological review*, 80(5), 352-373.

Relationship of Ubiquitous Technology Usage with Technology Competency

Rosnaini MAHMUD^{a*}, Muliati SEDEK^b, Habibah AB. JALIL^a & Shafee MOHD DAUD^a

^aUniversiti Putra Malaysia, Malaysia

^bUniversiti Teknikal Malaysia Melaka, Malaysia

ros_fpp@yahoo.com

Abstract— The objectives of the study were to (i) identify the level of U-Tech usage, (ii) determine the undergraduates' U-Tech competency level and (iii) determine whether there was a significant relationship between U-Tech usage and U-Tech competency. A total of 400 undergraduates from four faculties were randomly selected. The study employed the survey method in which the data were gathered through a 5 point-Likert scale questionnaire. The questionnaire consisted of 5 items (demographic information), 42 items (U-Tech usage) and 42 items (U-Tech competency) with the reliability of 0.958 for U-Tech usage and 0.971 for U-Tech competency. Data were analyzed descriptively (mean, percentage, frequency and standard deviation), and inferentially (Pearson correlation). The findings of this study revealed that majority of the undergraduates were at high level of U-Tech usage (mean = 4.39, SD = .895). The overall level of u-tech utilisation among the undergraduates was moderate, and the overall competency level of the undergraduate in using u-tech was observed to be moderate. Finally, results revealed that, there was a significant and positive relationship ($r = 0.335$; $p < 0.01$) between the undergraduates' use of U-Tech and their competency level.

Keywords- ubiquitous technology, Technical Undergraduates, Use, Competency

1. Introduction

In this digital era and with the technology-innovation pace, the most recent form of technology, the ubiquitous technology or *U-Tech*, has emerged and played an important role in diversifying educational settings. U-tech devices such as smartphones, laptops and tablets (Lei, 2010, Saadiah, 2010, Levin & Bruce, 2001) are gaining recognition as tools, not only to serve their original and basic purposes for communication, entertainment and organization, but also to be used as a strong mediator in education to support learning. Majority of the undergraduates incorporate U-Tech in classrooms and laboratories to assist them learn more effectively because this technology provides better understanding to them on what they are learning (Guertl, Chang, Edwards & Boruta, 2013). There are many factors that influence U-Tech usage including competency which have been identified to have affects on the use of U-Tech among undergraduates. Such factors have been explored in previous research (eg. Kadel, 2005; Mudasiru & Modupe, 2011). Successful integration of U-Tech depends largely on the competence of undergraduates in using and understanding the role of these digital and advanced technologies either for learning or leisure purposes.

Simply having the sophisticated U-Tech in hand and in the institution will not guarantee effective usage. Regardless of the quantity and quality of technology placed in classrooms, the key to how those tools are used is the undergraduate themselves. Therefore, undergraduates must have the competence and the right attitude towards technology (Kadel, 2005). Major technology competencies required were highlighted by Ahmad, Abdul Karim and Albakri (2013) to include competency in making personal use of the tools, mastery of a range of educational paradigms that make use of it, competency in making use of the tool as mind tools, competency in using technology as tools for learning which involves use of the technology and competency in understanding the standard dimensions of the use of U-Tech for learning.

Utilization of Technology in Technical University

Higher education system in Malaysia is designed to ensure that public higher education institutions will have the ability to build a reputation to be dynamic, competitive, able to anticipate and overcome the challenges ahead and be prepared to act effectively, as well as keep pace with globalization. It also focuses on the efforts to improve the ability of universities to perform the functions and responsibilities more efficient, transparent and effective in creating an excellent facilitating environment for their students. To date, MoE has listed out 11 universities as a focused university including four Malaysian Technical Universities which focusing more on the technical and engineering field and committed to be an excellent innovation-driven university. The four Malaysian

Technical University Networks or MTUN are Universiti Teknikal Malaysia Melaka (UTeM), Universiti Tun Hussein Onn Malaysia (UTHM), Universiti Malaysia Pahang (UMP) and Universiti Malaysia Perlis (UniMAP).

These universities are committed in producing excellent and skilled manpower to contribute to the advanced industrial countries especially in Malaysia, and at the same time aim to produce a ready technology-competence graduates for a direct fit with the requirements of the IT industry (TaskForce on Meeting and Human Resource Challenge for IT and IT enabled Services, 2003). On the other hand, the Engineering Accreditation Commission (EAC) of Accreditation Board for Engineering and Technology (ABET), has identified technology use skills, technology competency, multi-tasking and the ability to identify, formulate and solve engineering problem as part of the key themes in their assessment of skill trend.

Benefits of Ubiquitous Technology Utilisation

i) Promoting Flexibility in Learning

In higher learning, the use of u-tech as a learning tool could provide authentic learning opportunities for students, especially for engineering and technical students who need clear and explicit examples or stages in connecting electronic circuits, without the chance of doing it hands-on (Beetham & Sharpe, 2013). A study conducted among engineering educators and students showed that with technology, engineering educators were able to draw on the applications to simulate real-world environments and create actual arenas for experiments for their students. With technology too, their students could carry out 'bona fide' tasks as real workers, explore new environments, meet people of different cultures and employ a variety of tools to gather information and solve problems (Rodríguez, Granados & Muñoz, 2013).

ii) Promoting Engagement in Learning

Student engagement is used to 'depict students' willingness to engage in routine learning activities, such as attending class, submitting required assignments and following teachers' directive' (Manuguerra & Petocz, 2011). Several alternatives have been demonstrated to promote students engagement. Educators can intensify students' engagement by persuading their students to become more active participants in learning by providing collaborative opportunities for educational research, planning, teaching and evaluation (Martin et al., 2013).

iii) Promoting Collaborative Learning

Collaborative learning refers to the environment in which engage learners in a task where each individual depends on and is accountable to each other. These include both face-to-face conversations and computer discussions such as online forums and chat rooms via videoconferencing (Moore, 2013). Generally, collaborative learning is about working together where knowledge can be generated by sharing experiences and taking on symmetry roles (Wali et al., 2014). Collaboration represents a virtue in the online world. Rather than working on a one-to-one basis, technology enables students to collaborate with one another and work with a range of interactive and instructional resources.

iv) Promoting Personalised Learning

In the 21st century, students learn best when lessons are tailored to their individual interests, strengths and challenges (Arshad & Scott-Ladd, 2010). A study conducted in Malaysia by Mokhtar and Huoy (2013) found that with wireless classrooms and electronic instruction let students study at their own pace. Personalisation makes learning more adaptive and timely and this frees educators from the usual tasks such as marking papers manually and gives them more time to serve as instructional coaches for students. Personalised learning with u-tech puts learners at the centre of the education process. Here, students' activities are customised based on what they need to learn where learning can be received either one-on-one or in small groups. At the same time, with the use of technology, educators are able to track their students' progress and give feedback at real-time.

v) Promoting Speed in Information Accessibility

A continuous flow of information among users is often hailed as the important feature of u-tech (Gupta, 2013). For example, when using u-tech, the students are provided with numerous channels of input and output, thereby augmenting their efficiency in learning. According to Hwang et al. (2008), with technology, there are five combinations of interaction occurring namely learner-content, learner-teacher, learner-learner, learner-interface and learner-community. Students can access databases, contact other students, send messages to lecturers, work within the interface of the technology and systems provided, connect to community-wide discussion areas or connect to social network system like Facebook® and Twitter to keep them up-to-date with the latest news or to amass information.

vi) Promoting 21st Century Skills

In Malaysia, in regard to a review of the relationship between technology and 21st century skills, Fadzil and Abdol Latif (2011) reported that with the utilisation of new technology, students were able to produce high-calibre work with a range of technology providing opportunities for creativity. The researchers found that students utilised u-tech to exhibit creative thinking, increase knowledge and develop innovative products.

Technology Competency

BrckaLorenz, Haeger, Nailos and Rabourn (2013) refer to technology competency as the ability to handle a wide range of computer applications for various purposes which can be achieved through the process of learning, acquisition of knowledge and development of skills in using technology. In the context of engineering and technical education, technology competency is interpreted as the perceived skills, abilities, knowledge and other characteristics displayed by students (Passow, 2012). Technology competency is also considered as the most important skill that should be acquired by the engineering graduates before they enter the workforce. This is important, because the students are expected to deal with and be involved in technical skills while in the workforce, which require them to handle and utilise a wide array of technologies and machines (Male, Bush & Chapman, 2010). According to ISTE understanding of the technology competency pattern can also be based on the standards developed, which is NETS.S. The NETS.S serves as a set of standard in nurturing the practice of enhancing certain skills with the utilisation of technology in school up to university level as well as assisting students to promote 21st century skills.

A study conducted among engineering students in India by Goel (2006) concluded that technology competency had influenced the use of technology. He discovered that most undergraduates had excellent competency in using technology and this had influenced them to use the technology for learning. However, from the study, Goel found that most students used technology only for lower cognitive thinking level such as for specific subjects and as a general tool; the technology was not being used to its fullest capability. The use of technology for higher cognitive thinking at the level of analysis, synthesis, and evaluation was still lacking due the limited opportunities and exposure given to the students.

2. Problem Statements

Although many attempts have been made to identify undergraduates' U-Tech usage in higher education around the world, there is mostly superficial literature in this area (Abdullah, Wan Mohd Amin, Masor, Mohammad & Amirdin, 2011). In most studies that have been conducted, many have merely focused on the lecturers' and students' ICT literacy, rather than the use of U-Tech (Ahmad & Bakhtiari, 2007). In fact, there is little information available on how U-Tech is being used among technical undergraduates. Moreover, the field also lacks data to actually determine the level of U-Tech usage among the undergraduates and their competency level. Hence, this study fills the gap in the existing literature by determining the level of U-Tech usage and U-Tech competency level among undergraduates in one Malaysian Technical University Networks (MTUN). It also determined the undergraduates' U-Tech usage according to the National Educational Technology Standard for Students (NET.S).

3. Objectives

The study attempts to achieve the following objectives:

1. To identify the level of U-Tech usage among technical undergraduates.
2. To examine the competency level of technical undergraduates in the use of U-Tech.
3. To determine whether there is any significant relationship between technical undergraduates' use of U-Tech and competency level.

4. Methodology

This research deployed a survey method using a questionnaire to investigate the level of U-Tech usage among engineering students and their competency level. The questionnaire consisted of Section A (eight items on socio-demographic information), Section B (42 items on U-Tech usage and 42 items on ICT competency). The instrument was validated by a panel of experts and pilot tested. Based on the pilot study the obtained reliability was 0.96 for U-Tech usage and 0.97 for U-Tech competency. Data were analyzed descriptively (mean, percentage, frequency and standard deviation), and inferentially (Pearson correlation) using SPSS version 17. All items in the section B were measured on a five-point Likert scale.

5. Findings

Demographic Information

A total of 400 undergraduates from four universities participated in this study. Most undergraduates were from UTeM (n=175, 44%), followed by UTHM (n=154, 38%) and UniMAP (n=42, 11%). The least number of undergraduates was from UMP (n=29, 7%). The gender distribution was almost equal among undergraduates;

male (n=208, 52%) and female (n=192, 48%). The age of undergraduates varied from 22 to 25 years old. Many of the undergraduates were around 23 years (n=165, 41%). Those, of 22 years (n=113, 28%). Undergraduates of age 24 (n=79, 20%) and the fewest undergraduates were at the age of 25 (n=43, 11%).

Undergraduates' Level of U-Tech Usage

Results revealed that the overall level of u-tech utilisation was moderate. A majority of undergraduates (n=229, 58%) perceived their utilisation level as moderate, 168 (41%) undergraduates high with a maximum score of 223, and 3 (1%) undergraduates perceived their utilisation level as low with a minimum score of 98. From 229 (58%) undergraduates who perceived their utilisation level as moderate, 110 (28%) were males and 119 (30%) were females. From 168 (41%) undergraduates who perceived their utilisation as high, 95 (24%) were males and 73 (17%) were females. Finally, 3 (1%) undergraduates who perceived their utilisation as low, were all males.

Patterns in Competency in Using Ubiquitous Technology According to Categories

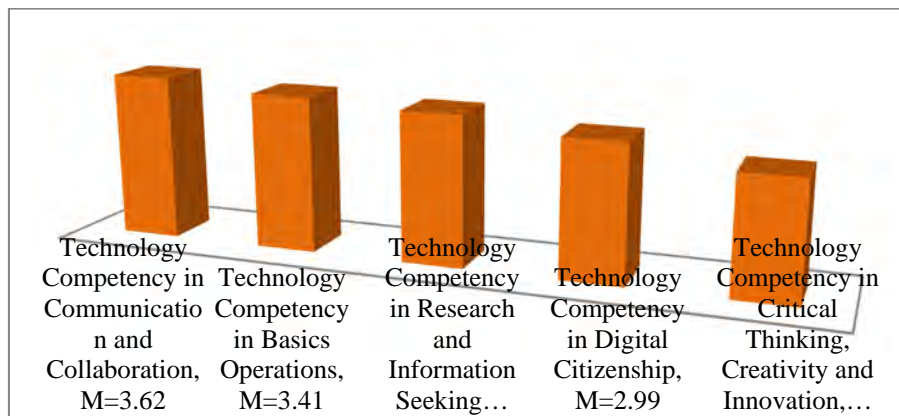

The highest competency in using u-tech was as a communication and collaboration tool (M=3.62, SD=.95), followed by basic operation tool (M=3.41, SD=.920), research and information seeking tool (M=3.28, SD=.95) and digital citizenship tool (M=2.99, SD=.93). Competency in using u-tech as a critical thinking, creativity and innovation tool was perceived as the lowest competency (M=2.57, SD=.99).

Relationship between technical undergraduates' U-Tech usage and competency level

The Pearson's correlation coefficient was used to examine the relationship between the undergraduates' use of U-Tech and their competency level. The correlation results between the research variables. Results revealed that, there was a significant and positive relationship ($r = 0.335$; $p < 0.01$) between the undergraduates' use of U-Tech and their competency level. The results indicated that undergraduates who used U-Tech very often have higher competency than those that never or occasionally used them. In other words, undergraduates who have high competency level tend to use U-Tech more frequently than the others.

Correlation Analysis between Relationships of technical undergraduates of U-Tech usage and U-Tech Competency Level

		U-Tech usage	U-Tech competency
U-Tech_usage	Pearson Correlation	1	.335**
	N	400	400
U-Tech competency	Pearson Correlation	.335**	1
	N	148	148

** . Correlation is significant at the 0.01 level (2-tailed).

6. Discussion and Conclusion

The study also shows that there is a significant and positive correlation ($r = 0.335$, $p < .01$) between undergraduates' U-Tech usage with their competency level. Hence, it is assumed that when undergraduates have high competency, there is a relative advantage in using U-Tech fully, perhaps for the higher level of thinking, such as in expressing complex concepts. This finding is consistent with those of Abdullah Abdullah, Wan Mohd Amin, Mansor, Mohammad Noor and Amirudin (2011) and Ahmad, Abdul Karim, Din and Albakri (2013) in which competency was the most influential factor related to technology use. Both studies reported that many users were in agreement that having sufficient technology competency and skills were primary importance in the successful and effective utilisation of technology.

References

- Abdullah, L., Wan Mohd Amin, W. A. A., Mansor, N. R., Mohammad Noor, N. M., & Amirudin, N. A. (2011). First year students' perceptions of their computer-related skills: A preliminary study. *Journal of Information Systems: New Paradigms*, 1(1), 38-42.
- adoption of instructional technology, *Journal of Applied Research in Higher Education*, 2(2), 34-49
- Ahmad, M., Abdul Karim, A., Din, R., & Albakri, I. (2013). Assessing ICT competencies among postgraduate students based on the 21st century ICT competency model. *Asian Social Science*, 9(16), 32-49.
- Arshad, M. A., & Scott-Ladd, B. (2010). Toward vision 2020: Organisational learning practices in Malaysia. *International Journal of Employment Studies*, 18(1), 89-123.
- Bakhtiari R., Babak N. Araabi, M. & Nili Ahmadabadi, "A cooperative learning approach to Mixed Performance Controller design: a behavioral viewpoint," in *Int. J. Intelligent Systems Technologies and Applications*, vol.2, no 3 2007.
- Beetham, H., & Sharpe, R. (2013). *Rethinking Pedagogy for a Digital Age: Designing for 21st Century Learning*. London: Routledge.
- Blankenship, S. E (1998). *Factors related to computer use by teachers in classroom instruction*. (Doctorial Dissertation, Virginia Polytechnic Institute and State University, 1998).
- BreckaLorenz, A., Haeger, H., Nailos, J., & Rabourn, K. (2013). Student perspectives on the importance and use of technology in learning. *Paper presented at the Annual Forums of the Association for Institutional Research*. Long Beach, California.
- Fadzil, M., & Abdol Latif, L. (2011). Driving e-learning towards ubiquitous e-learning. Retrieved January 1, 2011 from http://eprints.oum.edu.my/680/1/Driving_e-learning_mansor.pdf
- Goel, S. (2006). Competency focused engineering education with reference to IT related disciplines: Is the Indian system ready for transformation? *Journal of Information Technology Education*, 5(27), 27-52.
- Guettl, C., Chang, V., Edwards, A., & Boruta, S. (2013). Flexible and affordable foreign language learning environment based on web 2.0 technologies. *International Journal of Emerging Technologies in Learning (iJET)*, 8(2), 16-24.
- Gupta, S., & Bostrom, R. (2013). An investigation of the appropriation of technology mediated training methods incorporating enactive and collaborative learning. *Information Systems Research*, 24(2), 454-469.
- Hunsinger, D. S., & Corley, J. K. (2013). What influences students to use Dropbox?. *Special Issue: Cloud Computing*, 1(1), 39-52.
- Hwang, G. J., Tsai, C. C., & Yang, S. J. (2008). Criteria, strategies and research issues of context-aware ubiquitous learning. *Educational Technology and Society*, 11(2), 81-91.
- Kadel, R. (2005). *How teacher attitude affect technology*. *Learning and Leading with Technology*, 39 (5), 34-47.
- Lei, J. (2010). Quantity versus Quality: A new approach to examine the relationship between technology use and student outcomes. *British Journal of Educational Technology*, 455-472.
- Khalid, S., & Yamin, S. (2012). Experiences of e-learning at a Malaysian Technical University Network in Malaysia. Is there any success? *Malaysian Technical Universities Conference on Engineering and Technology*, 6, 613-617. Kangar: UniMAP, Malaysia.
- Levin, B. C. (1997). Educational Technology: Media for Inquiry, Communication, Construction and Expression. *Educational Computing Research*, 79-102.
- Liu, T. Y., & Chu, Y. L. (2010). Using ubiquitous games in an English listening and speaking course: Impact on learning outcomes and motivation. *Computers and Education*, 55(2), 630-643.
- Male, S. A., Bush, M. B., & Chapman, E. S. (2010). Perceptions of competency deficiencies in engineering graduates. *Australasian Journal of Engineering Education*, 16(1), 55-67.
- Manuguerra, M., & Petocz, P. (2011). Promoting student engagement by integrating new technology into tertiary education: The role of the iPad. *Asian Social Science*, 7(11), 61-77.

- Martin, R., Ostashevski, N., & Dickinson-Delaporte, S. (2013). Creating authentic iPad activities to increase student engagement: A learning design approach. In *World Conference on Educational Multimedia, Hypermedia and Telecommunication*, 1(2), 249-253.
- Mokhtar, S., & Huoy, L. S. (2013). Design of personal learning environment framework for learner autonomy. *4th International Conference on Computer Science and Information Technology (ICCSIT'2013)*, Dubai (UAE).
- Moore, D. F. (2013). One size does not fit all: Individualized instruction in a standardised educational system. *American Annals of the Deaf*, 158(1), 98-103.
- Mudasiru O. Yusuf, Modupe R. Balogun (2011). Student-Teachers' Competence and Attitude towards Information and Communication Technology: A Case Study in a Nigerian University. *Contemporary Educational Technology*, 2011, 2(1), 18-36.
- Passow, H. J. (2012). Which ABET competencies do engineering graduates find most important in their work?. *Journal of Engineering Education*, 101(1), 95-118.
- Rodríguez, J. C. F., Granados, J. J. R., & Muñoz, F. M. (2013). Engineering education through e-learning technology in Spain. *IJIMAI*, 2(1), 46-50.
- Saadiah, Y. E. (2010). The Definition and Characteristic of Ubiquitous Learning: A Definition. *International Journal of Education and Development using Information and Communication Technology*. , 117-127.
- Sampson, D. G., Isaias, P., & Ifenthaler, D. (2013). *Ubiquitous and Mobile Learning in the Digital Age: Papers from CELDA 2011*. United Kingdom: Springer.
- Wali, I., Faisal, M., Chowdhury, A. H., Alam, S., Muhammad, K. & Islam, M. (2014). Collaborative education: New frontier for future education and YUNUS social business. *Business Education and Accreditation*, 6(1), 101-110.
- Watson, D.M. (2001). *Pedagogy before technology: Re-thinking the relationship between ICT and teaching*. *Education and Information Technology*. 6(4):251-266. Retrieved 10 July 2010, from <http://www.springerlink.com/Content>.

Seamless Flipped Classroom Using SCROLL in CALL Class

Noriko UOSAKI^{a*}, Hiroaki OGATA^b, & Kousuke MOURI^c

^a*Center for International Education and Exchange, Osaka University, Japan*

^b*Faculty of Arts and Science and the Graduate School of Information Science and Electrical Engineering at Kyushu University, Japan*

^c*Graduate School of Information Science and Electrical Engineering*

* uosaki@ciee.osaka-u.ac.jp

Abstract: In this paper we have explored flipped classroom. How we can encourage students to learn outside-class is a key issue in flipped classroom. In our previous study it was found that our system called SCROLL (System for Capturing and Reminding Of Learning Log) contributed to the students' increased involvement in outside-class learning. SCROLL is expected to play an important role in its effective implementation of flipped classroom. A pilot evaluation was conducted to examine the effectiveness of our proposed learning scenario using SCROLL and SNS(Social Networking System). The result showed that it enhanced the students' outside-class learning, though more examination is necessary to conclude its contribution since there are other factors which contributed to boosting up outside learning time. Timing of posting outside-class task was also examined and the period of two weeks was found to be appropriate.

Keywords: flipped classroom, mobile assisted language learning, second language learning

1. Introduction

Growth of the Internet has enabled us to go beyond the interaction between individual learners and the system, and it realized collaborative learning that can occur simultaneously with group of learners connected to each other. Besides, New telecommunications technology such as Wi-Fi (wireless fidelity), Bluetooth, 3G and 4G (third and fourth generation), has enabled various kinds of portables devices (e.g. laptop or netbook computers, palmtop computers or PDA, mobile phones, smart phones, GPS devices, MP3 players, handheld electronic game devices). These technologies allow learners to learn anytime, anywhere, and provide them with multiple ways of learning throughout the day.

The progress of these technologies and realization of one device or more per learner have offered us a new learning environment called "flipped classroom". In flipped classroom, how we can encourage students to learn outside-class is a key issue. In our previous study, SCROLL contributed to the students' increased involvement in outside-class learning (Uosaki et al. 2013). Therefore we expected our system could play an important role in effective implementation of flipped classroom.

The rest of the paper consists of 4 sections: Theoretical backgrounds of our study were overviewed in Section 2. In Section 3, our developed system SCROLL is described. Section 4 includes the pilot evaluation experiments we have conducted to investigate how our system could contribute to the effective implementation of flipped classroom. Finally Section 5 concludes the study mentioning our future works.

2. Theoretical Backgrounds

2.1 Flipped classroom

Flipped classroom is a newly risen learning strategy and has gathered a lot of attention from researchers and educators of various fields in the recent years (Bergmann & Sams, 2012; Kiat & Kwong, 2014; Vaughan, 2014; Schmidt & Ralph, 2014). It is a kind of blended learning, where learning contents moved outside the classroom. According to Flipped Learning Network, ‘flipped classroom’ is defined as “a pedagogical approach in which direct instruction moves from the group learning space to the individual learning space, and the resulting group space is transformed into a dynamic, interactive learning environment where the educator guides students as they apply concepts and engage creatively in the subject matter.” More simply it is often defined as “school work at home and home work at school”. Theoretically it might be possible to conduct flipped classroom without technology. One possibility is to deliver paper-based learning contents to the students for reading before class. But when the term, “flipped classroom” or “flipped learning” emerged, it was already a generalized idea to deliver video contents. Therefore flipped classroom can be realized with the help from technology.

As one of the advantages of flipped classroom, Bergmann et al. (2011) has listed that flipped classroom is “a means to INCREASE interaction and personalized contact time between students and teachers.” It is also expected that it can be a means to increase interaction not only between students and teachers but among students. Thus it enables us to realize a student-centered collaborative learning, which is reported as one of the most effective way of learning in second language learning class (Chen, 2003). It is a growing research area attracting the attention of scholars of learning technology all over the world. Since it is an emerging research area, a lot of issues are to be explored in order to prove its effectiveness and its efficacy.

2.2 Mobile Learning

Mobile learning has generally been defined as learning with the use of mobile and wireless technologies. The concept for mobile learning was foreseen as early as 1970s with the Xerox Dynabook project which proposed a “self-contained knowledge manipulator in a portable package the size and shape of an ordinary notebook” (Sharples et al, 2009). It has been recognized as one of the natural directions toward which CALL (Computer-Assisted Language Learning) is heading (Chinnery, 2006; Stockwell, 2007). Thornton and Houser (2005) reported that the learners preferred mobile platform rather than PCs. Especially, mobile technologies have been expected to foster shifting from classroom-based learning to the one that is free from time and space boundaries. Since mobile technology is a fast-evolving, constantly advancing field, its infinite potential is inevitably expected to contribute to implementation of flipped classroom.

2.3 Motivations

One of the motivations for introducing flipped classroom is to make use of class time for collaborative activities. In Uosaki and Ogata (2009), the survey result shows that the participants, university sophomores, felt it was the most useful to conduct an interview with international students among various activities in their communicative English class. In fact, it is regarded as one of the most effective ways of learning languages to mingle with those who speak that language. Since one of the authors’ L2 learning class consisted of international and Japanese students, it was an ideal situation for language learners. In order to make most use of class time with group discussion, group presentation or any kind of collaborative activities, flipped classroom was introduced.

The other motivation is that learning time of the second language at school is far from sufficient in Japan and there is a strong necessity to boost up outside-class learning time (Uosaki et al., 2013). In order to solve this problem, flipped classroom is expected to be one of the key contributors. Taking the above mentioned elements into account, we have designed a class where students can mingle with peers during class with lecture part at home such as introduction of new terms.

3. SCROLL

3.1 System Design

We have developed a system called SCROLL (System for Capturing and Reminding of Learning Log) that allows learners to log their learning experiences with photos, audios, videos, location, QR - code (Quick Response code), RFID (Radio - frequency identification) tag, and sensor data and so on , and share and reuse them with others (Ogata, et al., 2010). SCROLL is a client-server application. The server side runs on Linux OS. It runs on different platforms such as Android mobile phones, PCs, and other smart phones and tablets. Users register what they have learned, which we call “ubiquitous learning logs (ULLs)”, to the system and view ULLs uploaded by themselves and others. Then the system automatically generates quizzes to help learners to recall their past ULLs.

ULL recorders facilitate learners' recording of their ULLs to the server whenever and wherever they learn new objects. As shown in Figure 1, in order to add a ULL, they take its photo, attach different kinds of meta-data such as its meanings in different languages, comments, tags and location information. They can share their new ULLs with others and view ULLs uploaded by themselves and others. They can keep their ULLs private if they wish.



Figure 1. Add ULL on Android

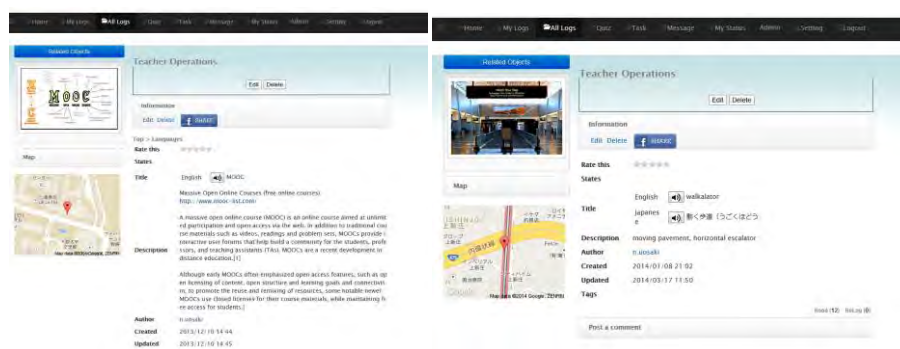

(1) “MOOC” for previewing before class (2) “walkalator” for reviewing after class
Figure 2. SCROLL Interface on the Web

It is expected that the sharing function that we can share ULLs with other learners instantly gives a great deal of support for implementation of flipped classroom. In this study, SCROLL was used for an instructor’s uploading terms to be learned for viewing before class (eg. “MOOC” in Figure 2(1)) and also terms which they learned during class for reviewing after class (eg. “walkalator” in Figure 2(2)). It was also encouraged learners to upload their own learning experiences, which is the system’s original purpose.

4. Evaluation

4.1 Subjects

Eleven university students in an international exchange class which was held weekly and conducted in English language at Osaka University participated in the evaluation. They were 5 international students (two from Netherland, two from Brazil, and one from Germany) and 6 Japanese students. They all reported they had Internet-connected PCs at home and were mobile phone owners.

4.2 Flipped classroom Design

The objectives of the subject class were 1) to improve their target language abilities and 2) to enhance mutual understanding of the culture of their mother countries and Japan. In order to make much of class time for discussion and other collaborative activities, as for lecture part such as learning new terminology, or briefings on how to use SCROLL, they were assigned to view contents on SCROLL before class, which are, in most traditional classes, supposed to be done during class. In addition, in order to encourage students’ outside-learning, they created their own Blogger site and were given home assignments of composing essays using their target language. Furthermore, in order to promote their

interaction outside-class, a Facebook group was created. The learning procedures are described in Figure 3.

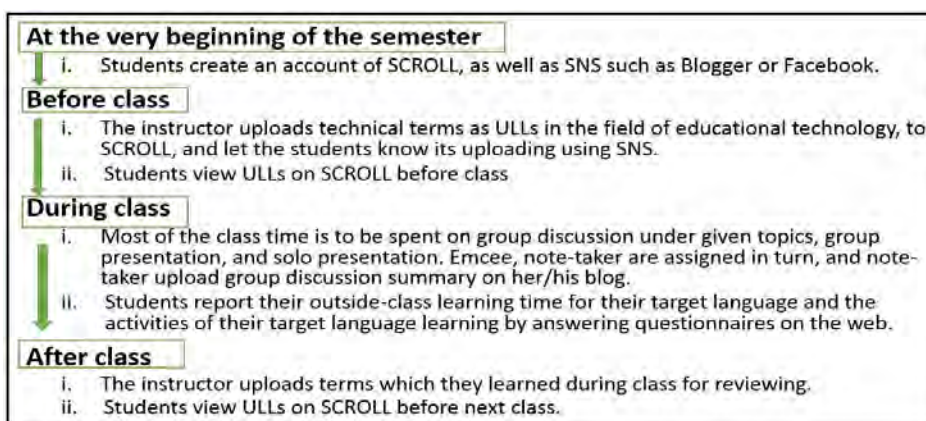

Figure 3. Learning Procedures

4.3 Results and Discussion

4.3.1 The average outside-class learning time for the target language learning

As mentioned, since it is a key issue how we can encourage students to get involved in learning outside-class in flipped classroom, the participants were asked to report their outside-class learning time and what kind of activities were included on the questionnaire site created by Google Drive.

The average outside-class learning time for each student was shown in Table 1. The whole class average was 53.9 minutes per day.

Table 1: Average outside-class learning time for the target language learning (per day)

Student #1	116.9
Student #2	75
Student #3	70.1
Student #4	65.8
Student #5	55.3
Student #6	51.8
Student #7	51.5
Student #8	47.3
Student #9	22.1
Student #10	21.6
Student #11	15.7
Mean (SD)	53.9 (27.6)

In our previous study, we had conducted an evaluation with university freshmen with/without SCROLL (Evaluation I) in order to find the answer to our hypothetical question: Does SCROLL contribute to the solution of lack of learning time? (Uosaki et al., 2013). Table 2 shows the average outside-class learning time for both groups: SCROLL group, 10.07 minute per day, without-SCROLL group, 6.6 minute per day. This indicates that the SCROLL group more committed to outside-class learning than without-SCROLL group, though the t-value (1.28) did not show its statistical significance.

Table 2: Average outside-class learning time in Evaluation I (per day) from (Uosaki et al., 2013)

	Outside-class Learning Time (min)Mean (SD)	<i>t</i>	Effect Size (d)
With SCROLL	10.07 (151)	1.28*	0.37 (Small)
Without SCROLL	6.6 (115)		

* $p = 0.11$

Compared with our previous study, outside-class learning time dramatically increased in this pilot study. Since one of the motivations for introducing flipped classroom was to boost up their outside-class learning time, the question was “How long did you study your target language outside class from date *X* – date *Y*?”, the same question asked in the previous one. There should be considered

various factors which contributed to boosting up outside learning time. The interview session was conducted for the hardest worker whose average outside-learning time for her target language was 116.8 per day. She said “I studied hard because I intended to take IELTS (International English Language Testing System). In her case, it seemed to be IELTS test that boosted up her outside-class learning time. Therefore it is too early to say flipped classroom was one of the contributors.

4.3.2 Appropriate timing of posting an outside-class task

1) One week Vs. two weeks

The students were assigned to view ULLs before class. Figures 4 shows the questionnaire results on whether they learned a new term, ‘flipped classroom’. The first questionnaire result shows only 33% answered ‘yes’ to the question whether they knew it. In fact the exact the same 33% said ‘yes’ to the question whether they viewed it. Next class, the instructor encouraged them to view it and the second questionnaire conducted one week later shows 100% of the students answered ‘yes’. It seemed it was unlikely for them to do their outside-class task during the first week. Their performance was highly improved after the teacher pushed them to view it. Therefore it is recommendable to give them at least two weeks to view ULLs as an outside-class task.

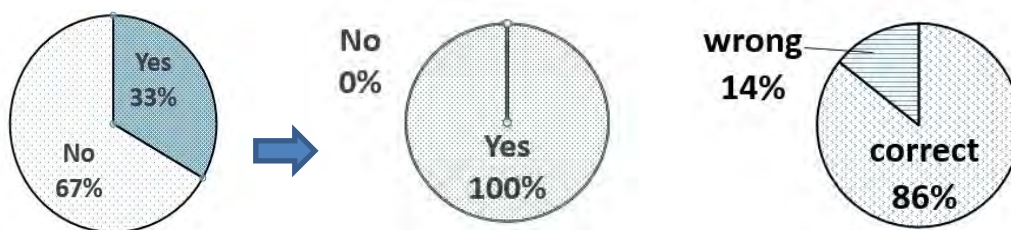

Figure 4. Do you know what 'flipped learning' means?

Figure 5. What does 'MOOC' stand for?

The students were assigned to view ‘MOOC’ uploaded to SCROLL as an assignment. The instructor gave them a reminder the next class and a multiple-choice quiz was conducted two weeks later. Figure. 5 shows its result. 86% gave a correct answer. The result also endorsed it was adequate to give them two weeks view an assignment content.

4.3.3 SNS contribution to outside-class learning

Since SNS function of SCROLL is yet to be ready, all the students created their own blog including the teacher and became readers each other and a Facebook group and a mailing list were also created in order to encourage outside-class interaction. According to the survey, 75% of the students used Facebook as a means of getting messages from the teacher (Figure. 6(1)). 55% of the students viewed Facebook posts every day, while 64% of the students viewed blog posts less than once a week (Figure.6(2)(3)). Therefore blog sites did not work as a means of communication outside-class, while Facebook group functioned as a group forum and they interacted each other using their target language outside-class, which, we believe, one of the contributors to boosting up their outside-class learning time of their target language.

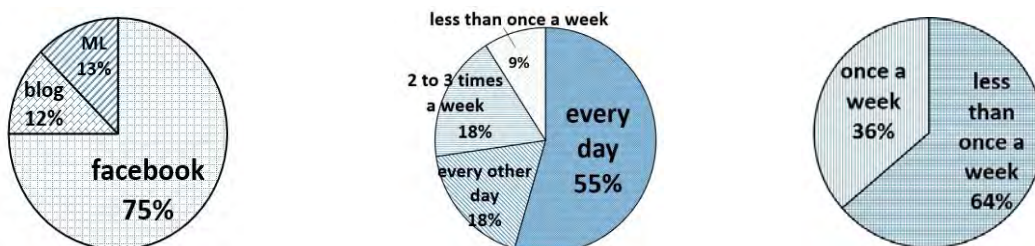

(1) Means of getting messages

(2) FB viewing frequency

(3) Blog viewing frequency

Figure 6. SNS contributions

5. Conclusion and Future Works

In this study, we explored flipped classroom and conducted a pilot evaluation. It was found that outside class learning time increased in our proposed learning scenario, but still more examination was necessary to conclude its contribution. Timing of posting outside-class task was examined and found out that the period of two weeks is appropriate as far as this pilot is concerned. Full evaluation is scheduled to be conducted in the near future to examine whether these findings are replicated.

Acknowledgements

This research work was supported by PRESTO from Japan Science and Technology Agency, and the Grant-in-Aid for Scientific Research No. 26350319 from the Ministry of Education, Culture, Sports, Science and Technology

References

- Bergmann, J., Overmyer, J., and Willie, B. (2011). The flipped class: What it is and What it is not. *The Daily Riff*. Retrieved from <http://www.thedailyriff.com/articles/the-flipped-class-conversation-689.php>
- Bergmann, J., & Sams, A. (2012). *Flip Your Classroom: Reach Every Student in Every Class Every Day*, (ISTE) International Society for Technology in Education ISBN-10: 1564843157 ISBN-13: 978-1564843159
- Chen, T. X. (2003) Interactive Learning of a Foreign Language. *Journal of Acoustic Society of America*, 114, 30-30.
- Chinnery, G. M. (2006). Emerging technologies. Going to the mall: mobile assisted language learning, *Language Learning and Technology*, 10 (1), 9–16.
- Flipped Learning Network retrieved from <http://flippedlearning.org/domain/46>
- Kiat, P.N., & Kwong, Y. T. (2014). The flipped classroom experience. *Proceedings of IEEE 27th Conference on Software Engineering Education and Training (CSEE&T)*, 39 – 43.
- Matsumoto, J., Mitsuhashi, H., Uosaki, N., Teshigawara, M., & Yano, Y. (2009). Learning Material Creation by Student Participation for Niche-Learning, *the IADIS International Journal of WWW/Internet (ISSN: 1645-7641)*, 7 (2), 31 – 46.
- Ogata, H., Hou, B., Li, M., El-Bishouty, M. M., Uosaki, N. and Yano, Y. (2010). What if we can log our ubiquitous learning?, *Proceedings of ICCE2010, Putrajaya, Malaysia*, 360–367.
- Schmidt, S.M.P., & Ralph, D.L.(2014). The Flipped Classroom: A Twist On Teaching, *Proceedings of The Clute Institute International Academic Conference* March 15 - 18, San Antonio, Texas (USA), 98-104. <http://www.cluteinstitute.com/proceedings/2014SAPapers/Article%20218.pdf>
- Sharples, M., Arnedillo-Sánchez, I., Milrad, M., and Vavoula, G. (2009). Mobile Learning, In Balacheff, N., Ludvigsen, S., De Jong, T., Lazonder, A., and Barnes, S. (Eds), *Technology-Enhanced Learning*, 233–249, Springer Netherlands.
- Stockwell, G. (2007). Vocabulary on the move: Investigating an intelligent mobile phone-based vocabulary tutor, *Computer Assisted Language Learning*, 20, 365–383.
- Stone, B.B. (2012). Flip Your Classroom to Increase Active Learning and Student Engagement, *In Proceedings from 28th Annual Conference on Distance Teaching & Learning, Madison, Wisconsin, USA*. http://www.uwex.edu/disted/conference/Resource_library/proceedings/56511_2012.pdf
- Thornton, P. and Houser, C. (2005). Using mobile phones in English education in Japan, *Journal of Computer Assisted Learning*, 21, 217–228.
- Uosaki, N. & Ogata, H. (2009). Supporting communicative English class using mobile devices', *Proceedings of mLearn2009*, Orlando, USA, 94–102.
- Uosaki, N., Ogata, H., Li, M., Hou, B., & Mouri, K. (2013). Enhancing Learning Time Using Learning Log System, *Workshop Proc. of ICCE2013*, 90-99, Bali, Indonesia, 18-22 November 2013.
- Vaughan, M. (2014). Flipping the Learning: An Investigation into the use of the Flipped Classroom Model in an Introductory Teaching Course, *International Journal of Education Research and Perspectives*, 41, 25-41.

Supporting E-Learning in Computer-poor Environments by Combining OER, Cloud Services and Mobile Learning

Simon Nyaga MWENDIA^{a*}, Sven MANSKE^b & H. Ulrich HOPPE^b

^aKCA University, Nairobi, Kenya

^bUniversity of Duisburg-Essen, Duisburg, Germany

*smwendia@yahoo.com

Abstract: Research supervision is an important type of support for advanced students when engaged in study projects or in writing their final theses. One of the most common complaints from research students is erratic or infrequent contact with supervisors, who might be too busy with other responsibilities or are not present frequently enough. High proliferation of mobile phones (i.e. 'mobile-rich') but no computer prevalence (i.e. 'computer-poor') in African countries calls for using mobile technologies to address this challenge. However, limitations of mobile devices (such as usage cost, memory capacity and small screen) are some of the barriers for mobile learning adoption. In this paper, we combine mobile learning with OER and Cloud Computing Services to enhance supervisors' availability to their research students, who are in 'mobile-rich' but 'computer-poor' learning settings typical for African universities.

Keywords: Mobile learning, Cloud Computing, Open Educational Resources

1. Introduction

A case study conducted by Muyinda, Lubega, & Lynch (2008) in Makerere University observed that the face-to-face collaboration between supervisors and research students was inadequate. The students were frustrated by the 'non-availability' of their supervisors. This includes limited face to face interactions that required student to physically meet their supervisors in the campus premises.

By the end of 2012, Africa had a 73% SIM penetration (Connections divided by total population) and is estimated to reach 97% by 2017 (Kearney & GSMA, 2013). However, Computer Access is still very low in this region. A survey conducted by Calandro, Stork & Gillwald (2012) has revealed that in 10 African countries, only 30% of the population have access to computers, while twice as much (60%) have access to mobile phones.

Although, technical limitations and cost of using mobile phones hinder large scale adoption of mobile learning approaches (Isaacs, 2012), incorporating the use of open education resources (OER) and Cloud Computing services in mobile learning can be used to address these challenges.

This paper discusses how OER and Cloud Computing Services can be combined with mobile learning approaches to support research supervision processes in 'mobile-rich' but 'computer-poor' learning environments typical for African universities.

2. Related Work

2.1 Research Supervision Process

According to Hockey (1996), the supervision of students' project work is a complex social process that consists of strategies employed by supervisors for allowing research students to complete their research project successfully. Studies show this complexity to be further reinforced by the fact that the process itself is dynamic in nature. The strategies and tactics selected by supervisors and the way they are implemented depend on a number of factors within the research process that are fluid. There are three strategies which can be adopted (Spear, 2000). That is: i) *Strong Interaction*, which involves sharing of responsibilities in the running of an experiment, regular group meetings (usually after every

5 days) and continuous interaction (collaboration) between supervisor and student; ii) *Intermediate Interaction* is viewed as the most common strategy today, which requires the supervisor and student to agree on meeting frequency usually on weekly basis to discuss research progress; iii) *Weak Interaction* involves irregular and infrequent meetings with the supervisor, whose interval can be several months.

2.2 Mobile Learning

In recent years, there is increased attention in mobile learning by educators, companies, researchers and policy makers, which has resulted to variously definitions of mobile learning (Muyinda, Lubega, & Lynch, 2010). For the purpose of this study, we will adopt the definition by Parsons & Ryu(2006), which states that mobile learning is a form of electronic learning (E-learning) that use mobile devices.

The current forms of mobile learning can be classified into three categories based on their primary objectives(Mwendia & Buchem, 2014). These include: i) Context sensitive mobile learning, which aim at supporting learning by considering the learner's current context (such as activity, identity, and social relations); ii) Mixed modes of representation learning, which aims at improving the meaning of learning content by allowing learners to participate in a media-rich environment, for example, is using a mixture of video, audio and text to present the same learning content; and iii) Ambient learning, which aims at enabling anytime, anywhere and anyhow access to personalized and high quality E-learning material. This category is distinguished from other E-learning services by three main features: Firstly, Multi-modal Broadband Access enables learners to access different modes (e.g. text, audio and video clips) of online E-learning materials. Secondly, Content Management allows integration of existing knowledge catalogues and e-learning resources using meta-data language. Thirdly, Context Management enables capturing and using learners' context(e.g. personal profile, activities) to deliver relevant content (Paraskakis, 2005).

Although there is high proliferation of mobile phones in Africa, mobile learning is still in its infancy, partly because of limitations associated with mobile devices such as small screen, low storage capacity and communication costs(e.g. text messaging cost) (Isaacs, 2012).

2.3 Cloud Computing Services

Studies show that there are several definitions of Cloud Computing. In this paper, we will adopt the definition of Cloud Computing as a form of computing where largely scalable IT-enabled capabilities are provided as a service to external clients using Internet technologies(Plummer, Bittman, Austin, Cearley, & Smith, 2008). In the field of technology-enhanced learning(TEL), there are four categories of Cloud Computing Services that can be used to overcome certain limitations of mobile devices, server systems or desktop computers, especially to enhance accessibility and interoperability in technology-enhanced learning scenarios(Jansen, Bollen, Baloian, & Hoppe, 2013). These are:

- Cloud-based *Communication Services* can help to exchange information between learners in collaboration learning scenarios, for example, chat features in Facebook may be used to support group discussions.
- Cloud-based *Repository Services* can facilitate the integration of learning objects in the cloud, for example, storage services offered by Amazon Simple Storage Service (S3), Dropbox, Youtube, Instagram and Flickr.
- Cloud-based *Production Services* can facilitate the creation of new content and/or improve its quality, for instance, using web-based applications(e.g. 'Mindmeister') to create mind maps.
- Cloud-based *Processing Services* can help to process or analyze data, particularly large amount of data. A good example is the ' Amazon Elastic Map and reduce' service that can be used to analyze huge data set with minimal effort.

However, more research is needed to investigate benefits of combining these services based on their potential functions for education usage, especially in mobile learning scenarios.

2.4 Open Educational Resources (OER)

According to Butcher (2011), open educational resources (OER) refers to any learning resources such as course materials and multimedia applications, which have been constructed for teaching and

learning and are openly accessible for use by educators and learners, without requiring them to pay royalties or license fees. Cloud-based applications can be used to facilitate networking, sharing, communication, and the production and publishing of OER (Ally & Samaka, 2013). Some of the benefits for incorporating OER in mobile learning include:

- Improving quality of learning materials through peer review activities such as editing, adding and mixing (Park, 2013).
- Reducing communication cost by using free OER tools that supports free exchange of messages during collaboration without paying for access fees or licenses (UNESCO/COL, 2011).

3. Applications Scenario and Requirements Analysis

3.1 Scenario

According to Spear (2000), intermediate interaction is the most common strategy that is used to implement research supervision process in universities. We therefore focus on this strategy by discussing an example scenario, which was observed at KCA University in Kenya as a case study for this research.

Bachelor of Information Technology (B.Sc. IT) is one of the degree programs offered by KCA University, which enrolls about 50 students per semester. The Research project unit, is one of the course units that are offered in the program requiring students to do a computer related project of their own choice. The project is progressively evaluated by an allocated supervisor (usually a lecturer) from the start to the last stage of the project. At each stage of research progress, there are two main activities. Learning activity involves receiving guidance from the supervisor through provision of learning materials and collaboration. Evaluation activity involves submission of deliverable and oral presentation to the supervisor, who provides feedback (i.e. marks, remarks) to the student. This process is progressively repeated until the final dissertation is submitted. In order to facilitate the project supervision process, mobile learning can be adopted in universities like KCA University.

3.2 Value-Adding Functions on Mobile Devices

Value-adding functions provided by mobile devices competes with those offered by printed materials. These functions promote the shift from traditional Distance Education Learning (DSL) that utilizes printed materials, towards mobile learning. The following table illustrates these functions.

Table 1: Value-adding functions of mobile phones compared to printed materials.

Mobile devices	Printed materials
Interactive support enables learners to communicate with others through feedback channels e.g. social media.	No collaboration (interaction) support due to the lack of feedback channels.
Multi-modal support allows access to dynamic content such as video and audio clips.	Can only support access to static content such as text and images.
Content in the same learning object can be updated dynamically through copy and paste features.	Content cannot be dynamically updated. It only be replaced with increased cost.

4. Proposed Learning Approach and System

The primary objective of ambient learning is to provide easy E-learning by supporting access to personalized and high quality content at anytime, anywhere and anyhow (Paraskakis, 2005). Among the three categories of mobile learning, this objective of ambient learning seem to be more appropriate for enhancing supervisors' availability to their research students. We therefore choose to adopt ambient learning as a form of mobile learning that can be used to support research supervision process in bachelor or master degree programs.

Ambient learning is described as combining requirements of learning paradigms and characteristics of ambient intelligence (e.g. embedded, context awareness, adaptation, anticipation) (Bick, Kummer, Pawlowski & Veith, 2007). Using this description, we propose a new form of ambient

learning that consists of ambient intelligence characteristics and combines mixed modes representations learning with context sensitive learning, which use mobile devices, cloud-based services and OER for learning support. The distinguishing components of our proposed architecture are:

- The Embedded Mobile Application helps to overcome display limitations of mobile devices by supporting context awareness (i.e. capturing learner's context) and presenting personalized user interface for learners to choose preferred mode of representation (i.e. audio, video or text) (Bick, Kummer, Pawlowski & Veith, 2007).
- Cloud Computing Services help to overcome storage limitations of mobile devices (Jansen et al.2013- see above).
- The Content Manager searches and selects the most relevant online learning materials (videos, audios and text documents) from the cloud- based repositories by considering learners' context obtained through mobile application (Paraskakis, 2005).
- The Context Manager receives, evaluates and stores learners' context in the context database. Examples of context include learner's identity, education level, preferences and so on (ibid).
- Multimodal Mobile (MM) Broadband Access facilitates internet access to multiple modalities of representations such as audio, video and text modes at anytime, anywhere and anyhow using existing mobile broadband technologies such as wireless networks and internet enabled mobile phones (ibid).
- The Context Database stores learners' context (e.g. preferences, profile, learning stage, etc.) that is captured by mobile application. Therefore, the database is connected to the context manager.
- Open Educational Resources (OER) refers to freely available online learning materials (e.g. documents, video and audio clips) that are stored in Cloud-based Repositories (Butcher, 2011).

Figure 1 illustrates how these components are interconnected. It shows that learners can access personalized Cloud Computing Services (i.e Communication, OER repository and Production services) using mobile devices and adaptation components (i.e the context manager, the content manager and the context database) that run on local web server to ensure data confidentiality.

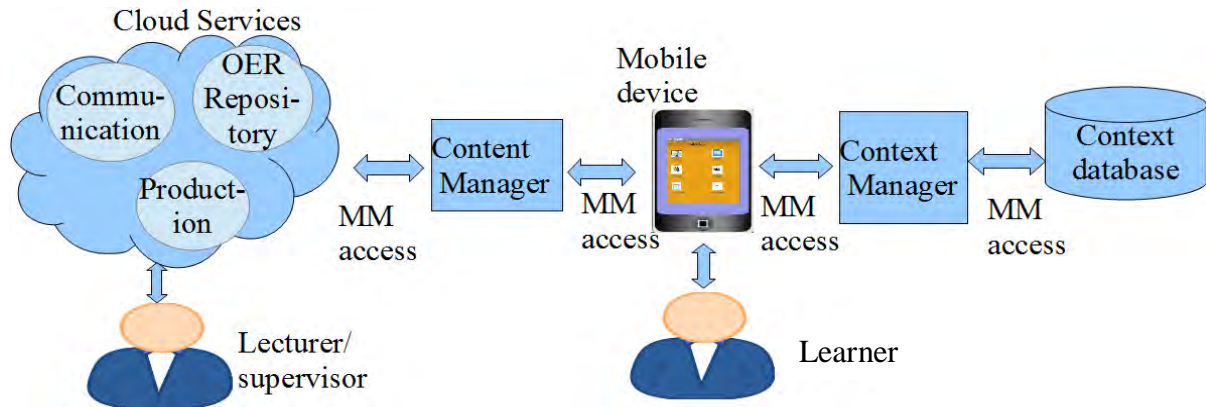

Figure1. Proposed system architecture.

5. Implementation

The effectiveness of the proposed learning approach needs to be evaluated before its adoption. To facilitate this, a prototype was developed during a stay of the first author at the University of Duisburg in Germany and later piloted at KCA University in Kenya starting from mid May 2014. The prototype consists of mobile application that runs on smart phones and a backend web server for hosting adaptation components (i.e. the context database, the context manager and the content manager). It also supports mobile access to Cloud Computing Services that are relevant to learners' individual context. Cloud-based applications connected to the prototype are: i) Google Docs for creating study guides and progress appraisals; ii) Facebook for collaboration support; and iii) Dropbox for managing OERs (i.e. storing, sharing, and deleting). Full implementation of the prototype is scheduled to start from January 2015 at KCA University and can be demonstrated using the following walk through example that includes screen captures of the prototype.

Example: Peter is a university student with a smart phone but has no personal computer at home. He has just registered for the research project unit through his phone and would like to start the learning process while at home during the weekend. Upon login, the mobile application his smart phone checks the context database and notices that no feedback has been posted so far. The application determines that Peter is a beginner and anticipates that next learning material is the proposal guide. The multi-modal access screen is then presented (as shown in Figure 2) so that Peter can choose his mode of access (e.g. video, text or audio). Peter chooses the audio mode, which will allow him to listen through headphones while he is cleaning the house. The application downloads MP3 files from OER repository (as shown in Figure 3) to allow the playing the audio file even when there is no internet connection (offline). After listening for 30 minutes, Peter decides to do a test for evaluating his proposal idea. Now he chooses the assessment option(as shown in Figure2). The application then presents the Progress Appraisal form, which contains diagnostics questions (for identifying knowledge gaps) and reflective questions (to help student evaluate himself) (as shown in Figure 4). Peter answers all the questions and submits them by pressing the submission button.

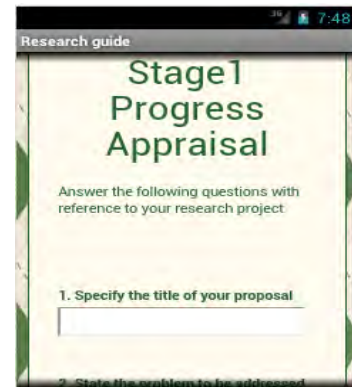
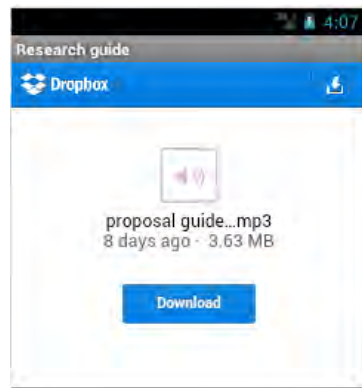
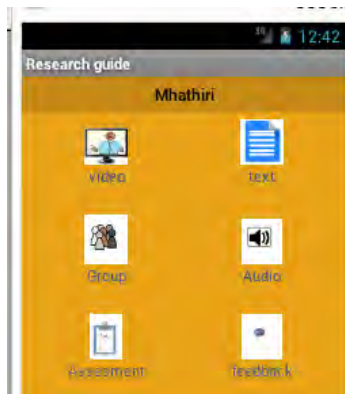

Figure 2. Main menu screen. Figure 3. Stage 1 content. Figure 4. Stage1 assessment.

Before closing the application, Peter presses the Group button(as shown in Figure 2), which displays Facebook page as shown in Figure5. He then writes a message to notify his supervisor that he has submitted stage1 progress appraisal. On receiving the notification, the supervisor uses his tablet to download the appraisal document in PDF format (as shown in Figure 6). He evaluates Peter's submitted work and posts feedback (i.e. marks and remarks) using his tablet as shown in Figure 7.

During the next learning session, Peter logs in and presses the Feedback button at the bottom of the Multi-modal access screen (as shown in Figure 2) .The mobile application searches for feedback posted by the supervisor in the database and presents it on the screen. This process continues for several days until Peter completes all the required learning stages.

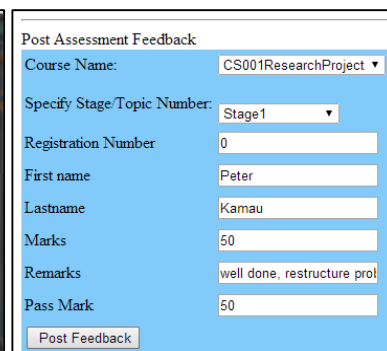
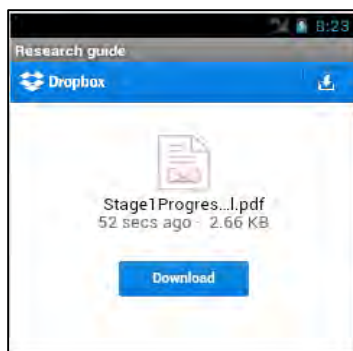

Figure 5:Facebook page Figure 6: Downloading Figure 7: Posting feedback

6. Conclusions and Further Work

This paper discussed the proliferation of mobile phones and non-prevalence of computers in African universities. Mobile phones can be used to reach large proportion of learners but they are associated

with limitations such as usage costs, small screen and limited storage capacity. Based on the digital status of African universities and the need to address limitations of mobile devices, a new learning approach has been proposed, which integrates mobile learning with open education resources (OER) and Cloud Computing services. In order to evaluate the approach, a mobile application has been developed to simulate how the new approach can be used for facilitating to access web based applications that offer Cloud Computing services. These include: Drop box, Google Docs and Facebook. Screen captures obtained from the simulator are included in this paper.

Further work is expected to focus on evaluating the effectiveness of the proposed approach. This can be done through conducting experiments in 'mobile-rich' but 'computer-poor' learning environments, especially concerning African universities. Additionally, there is need to explore other cloud-based applications that can support mobile learning scenarios.

Acknowledgement

This work has been supported by a research grant of the German Academic Exchange Service (DAAD).

References

- Ally, M., & Samaka, M. (2013). Open Educational Resources and Mobile Technology to Narrow the Learning Divide. *International Review of Research in Open and Distance Learning*, 14(2).
- Butcher, N. (2011). Basic guide to educational resources. Commonwealth of Learning & UNESCO.
- Hockey, J. (1996). Strategies and tactics in the supervision of UK social science PhD students. *International Journal of Qualitative Studies in Education*, 9(4), 481–500. doi:10.1080/0951839960090409
- Isaacs, S. (2012). *Mobile Learning for teachers: Exploring the Potential of Mobile Technologies to Support Teachers and Improve Practice in Africa and the Middle east*. (Working paper). UNESCO Working Paper Series on Mobile Learning. Paris, France: United Nations Educational, Scientific and Cultural Organization (UNESCO).
- Jansen, M., Bollen, L., Baloiian, N., & Hoppe, H. U. (2013). Using Cloud Services to Develop Learning Scenarios from a Software Engineering Perspective. *Journal of Universal Computer Science*, 19(14), 2037–2053.
- Kearney, A.T., & GSMA. (2013). *The Mobile Economy 2013* (Research report) (p. 101). London, UK.
- Muyinda, Paul, Lubega, J. T., & Lynch, K. (2010). Mobile Learning Objects Deployment and Utilization in Developing Countries. *International Journal of Computing and ICT Research*, 4(1), 37 – 46.
- Muyinda, Paul, Lubega, J., & Lynch, K. (2008). Mobile Research Supervision Initiative. *International Journal of Computing and ICT Research (IJIR)*, 1(1), 48–59.
- Mwendia, S., & Buchem, I. (2014). Open mobile ambient learning: The next generation of mobile learning for mobile-rich but computer-poor contexts. *UNESCO Mobile Learning Week 2014*. Paris, France: UNESCO.
- Paraskakis, I. (2005). Ambient Learning: a new paradigm for e-learning. Presented at the International Conference on Multimedia, Information and Communications Technologies in Education, Spain.
- Park, J. (2013). Open curriculum alternatives to MPAA's new anti-piracy campaign for kids. *Creative Commons (CC)*. Retrieved from <http://creativecommons.org/tag/oeer>
- Parsons, D., & Ryu, H. (2006). A Framework for Assessing the Quality of Mobile Learning. *Proceedings of the 6th IEEE International Conference on Advanced Learning Technologies*. Kerkrade, The Netherlands.: Massey University website.
- Plummer, D. C., Bittman, T., Austin, T., Cearley, D. W., & Smith, D. M. (2008). Cloud Computing: Defining and Describing an Emerging Phenomenon. *Emory University website*. educational.
- Spear, R. (2000). Supervision of research students: Responding to student expectations. Australian National University. Retrieved from https://digitalcollections.anu.edu.au/bitstream/1885/41534/2/GS00_1.pdf
- UNESCO/COL. (2011). Guidelines open education resources (OER) in Higher Education. Commonwealth of Learning/UNESCO.

Applying POE framework in a simulation system for facilitating physics learning with Tablet PCs

^aChia-Ching Lin, ^bFo-Jui Chen, ^aChen-Chung Liu

^aGraduate Institute of Network Learning Technology, National Central University, Taiwan

^bDepartment of Computer Science & Engineering, Yuan-Ze University, Taiwan

Abstract: This study attempts to propose a model integrating real videos into the development of simulations on iPads to support students' science learning about motions based on Predict, Observation and Explanation (POE) framework. Motion examples in videos embedded in the simulation were employed to assist students in contrasting stimulated phenomena and real-world cases for meaning making about force and motion. A preliminary study found that the students, who were given with the video clips, exhibited significantly higher frequencies of modeling (manipulating variables to simulate the movement) and replaying (watching the simulation) than those who were not given with the videos while dealing with complex motion. Such a result suggest that integrating video clips into the simulation could be helpful to stimulate students' involvements in reviewing and revising the simulation while exploring more complex concepts.

Keywords: Simulation, science learning, iPads, video, POE

1. Introduction

Many researchers (Rutten et al., 2012; Smetana & Bell, 2012) have suggested that computer simulations could be a potential option for facilitating science learning and instruction. Computer simulations can offer many advantages to support students' science learning by ways of making abstract concepts and tacit knowledge of science visible and concrete. Students can see and interact with representational models of natural phenomena that would be hard to observe in the real world to carry out scientific discovery learning (de Jong & van Joolingen, 1998). However, researchers asserted that simulations should be carefully regarded as abstract models by its nature different from the physical entity in the real world, even though computer simulations are useful to the concretization of scientific concepts and phenomena (Horowitz, 1999).

Such a difference raises the concerns about how to strengthen the connection between stimulated representations and real-world situations. If students are engaged in conceptualizing science phenomena in the natural world, they actually learn science from real experience of what they were engaged in (National Research Council, 2011). For this reason, computer simulations demonstrated with real-world examples may be helpful to bridge the gap between the conceptual world and reality, and then help them develop better understanding of scientific principles and phenomena conveyed by the stimulated models. Therefore, this study attempts to propose a model integrating real videos into the development of simulations on iPads to support students' science learning based on Predict, Observation and Explanation (POE) framework. Motion examples in videos embedded in the simulation were employed to assist students in contrasting stimulated phenomena and real-world cases for meaning making about force and motion. Students are expected to acquire better understanding about scientific concepts related to the subject of force and motion within the research context conducted in this study.

2. The POE framework to apply simulations with video clips on iPads

In this study, pictures, texts, simulations and videos were employed to construct a series of multiple representations in support of science learning about force and motion on iPads. In the prediction phase,

a descriptive question with an example illustration as shown in Figure 1 was offered to elicit students' idea of the particle movement being subject to the resultant of two different forces.

In the observation part, a simulation including a set of parameters (i.e., position, initial velocity, forces) was employed to demonstrate the effect of forces on the motion of a particle. Students were asked to choose a video clip that demonstrate a certain type of movement and simulate the movement by the use of the simulation system. Students were allowed to manipulate the given variables and observe the consequent movement of the particle as a way to validate their prediction made previously. The simulation system updates the value of the velocity to reflect the correct velocity of the particle's motion. The students were asked to construct at least two different combinations of the parameters in representative of the movement. The aim of combining hands-on simulation and example videos is to strengthen the connection between the stimulated and physical phenomena in support of students' knowledge transfer and integration.

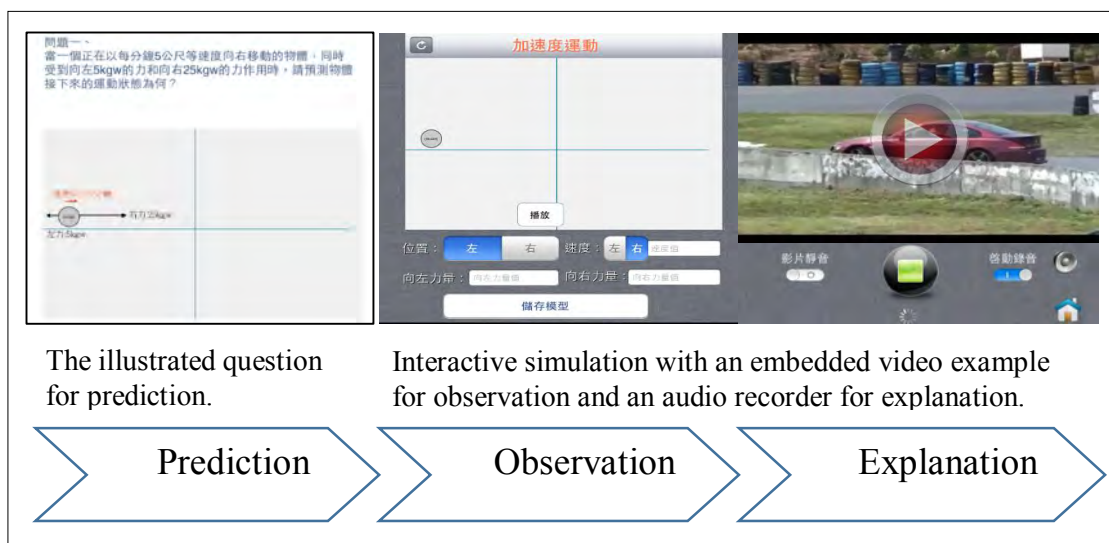

Figure 1. Interactive simulation with an embedded video example in a POE framework

Finally, a mechanism for voice recording is conducted to the explanation step that students are allowed to articulate their own explanations of what they observed and learned through the interaction with the simulation. The students are encouraged to describe the motion of an object by its position, direction of motion, and speed, as well as explicate how forces act on the object along a straight line and may cause changes in the speed or direction of the object's motion. The recorded explanations could be replayed and revised.

3. A Preliminary study

A preliminary study was conducted to understand whether video clips combined with the simulation is helpful to enhance science learning. Comparisons of activity log data between the control group (29 students given with simulation without video clip) and experimental group (28 students given with simulation with video clips) were made. The results indicate that the students in experimental group exhibited significantly higher frequencies of modeling (manipulating variables to simulate the movement) (2.92 versus 1.91, $p < .05$) and replaying (watching the simulation) (8.83 versus 4.76, $p < .05$) than those in control group while dealing with accelerated motion. There were no significant differences of modeling and replaying between the groups for the other two types of movements. The findings suggested that integrating video clips into the simulation could be helpful to stimulate students' involvements in reviewing and revising the simulation while exploring more complex concepts.

4. Concluding remarks

Through the application of the well-designed simulations and supportive mechanisms students would be facilitated to construct their own understanding through interacting with simulations about conceptual knowledge. This study aimed to support students' science learning on the topic of force and motion through interacting with a set of simulations. The POE approach was adopted as explicit guidelines to design and develop the POE-based simulations of force and motion for a normal science course in a classroom setting. The mechanism of video clips and sound recording were utilized to support the students' observation and explanation of the POE-based simulations in experimental condition. This combination is on the strength that everyday physical events may held great potential for students' interpretation of the relationships between scientific principles and real-world situations. Students' own observation and explanation are viewed as a critical enabler for their active and productive learning about force and motion.

Comparisons of the students' interactions with simulations between the groups revealed that the students in experimental group exhibited more frequent interactions with simulations for a particle motion with acceleration. It could be suggested that integrating example video clips into simulations could be helpful to stimulate students' engagements with simulations, especially for exploring some difficult concepts such as acceleration. On the basis of these findings, employing the POE-based simulations along with the application of analogous video examples may offer students an alternative ways to assess the ideas coming up with their interactions with simulations.

References

- de Jong, T., & van Joolingen, W. R. (1998). Scientific discovery learning with computer simulations of conceptual domains. *Review of Educational Research, 68*(2), 179-201.
- Horowitz, P. (1999). *Designing computer models that teach*. In W. Feurzig & N. Roberts (Eds.), *Modeling dynamic systems*. New York: Springer-Verlag.
- National Research Council. (2011). *Learning science through computer games and simulations*. Committee on Science Learning: Computer Games, Simulations, and Education, M.A. Honey, and M.L. Hilton (Eds.). Board on Science Education, Division of Behavioral and Social Sciences and Education. Washington, DC: The National Academies Press.
- Rutten, N., van Joolingen, W. R., & van der Veen, J. T. (2012). The learning effects of computer simulations in science education. *Computers & Education, 58*(1), 136-153. doi: 10.1016/j.compedu.2011.07.017
- Smetana, L. K., & Bell, R. L. (2012). Computer simulations to support science instruction and learning: A critical review of the literature. *International Journal of Science Education, 34*(9), 1337-1370.

Authoring Augmented Reality as Situated Multimedia

Marc Ericson C. SANTOS^{a*}, Jayzon F. TY^b, Arno in Wolde LUEBKE^a,
Ma. Mercedes T. RODRIGO^b, Takafumi TAKETOMI^a, Goshiro YAMAMOTO^a,
Christian Sandor^a & Hirokazu KATO^a

^aInteractive Media Design Laboratory, Nara Institute of Science and Technology, Japan

^bAteneo Laboratory for the Learning Sciences, Ateneo de Manila University, Philippines

*chavez-s@is.naist.jp

Abstract: Augmented reality (AR) is an enabling technology for presenting information in relation to real objects or real environments. AR is *situated multimedia* or information that is positioned in authentic physical contexts. In this paper, we discuss how we address issues in creating AR content for educational settings. From the learning theory perspective, we explain that AR is a logical extension of multimedia learning theory. From the development perspective, we demonstrate how AR content can be created through our in situ authoring tool and our platform for handheld AR.

Keywords: augmented reality, authoring tool, multimedia learning, situated learning

1. Introduction

Augmented reality (AR) is an emerging technology for educational settings. Our review (Santos et al. 2014) provides a useful summary of AR prototypes applied to learning. Currently, researchers have varying definitions for AR, depending on which of its features are emphasized. We define augmented reality learning experiences based on Azuma's (1997) definition of AR – "3-D virtual objects are integrated into a 3-D real environment in real time". This is a conceptual definition that is independent from enabling technologies. The "objects" mentioned are more understood as inserting computer graphics and aligning it to a video feed of the real environment. However, Azuma et al. (2001) explained that AR can potentially apply to all senses.

Although there are many AR prototypes for learning, researchers do not usually use the most important feature of AR – showing an explicit relationship between the virtual learning content and real objects found in the natural environment. There are many definitions for AR. As a technology for education, we propose to define AR to be *situated multimedia*. In other words, AR is multimedia (text, sound, images, animations, etc.) that is displayed in relation to the real environment. Thereby, the real environment becomes the "authentic context" of learning that is characteristic of situated learning (Herrington & Oliver, 1995). From this formalization, we then discuss our implementation of authoring tools that teachers can use for creating such situated multimedia.

2. Extending Multimedia Learning Theory to Augmented Reality

Previous research works have described AR to offer contextual learning (Specht et al., 2011) and ubiquitous learning (Dede, 2011). Indeed, AR has several benefits because it applies situated cognition (Wu et al., 2013). In this paper, we take a step back and explain that AR is essentially multimedia. As such, multimedia learning theory applies. In this theory, multimedia refers to pictures and words. It assumes dual-channels, limited capacity, and active processing (Mayer, 2009). First, humans have two separate channels for perceiving visual and auditory information. Second, humans have a limited capacity of information that they can attend to. Lastly, learning only takes place if learners actively make sense of incoming information using their prior knowledge. AR visualization can reduce cognitive load, thereby, allowing students to allot more effort to actively processing

information. In a previous study (Fujimoto et al., 2012), we have shown that using AR visualization enables better memorization of abstract symbols. This result is consistent with the prediction of spatial and time contiguity principles of multimedia learning.

Multimedia learning is learning with *pictures* and *words* (both written and spoken). This theory applies to AR if we make the following logical substitutions: The real objects or the real environment is the *picture*. The virtual texts, symbols and pre-recorded sounds are the *words*. A *new picture* is created when real objects, real environment and the *original picture* are combined.

3. Authoring Augmented Reality Content

One of the difficulties for adapting situated multimedia is the lack of authoring tools to make educational content. Currently, several authoring tools exist. However, they do not address the needs of teachers for a simple but flexible tool for everyday use. Software libraries like the ARToolkit (Kato & Billinghurst, 1999), Vuforia¹ and PointCloud SDK² are authoring tools for programmers.

MacIntyre et al. (2004) and Hengel et al. (2009) developed desktop-based systems for non-programmers so that they can author AR content. On the other hand, Langlotz et al. (2012) created a system for handheld-based authoring. Although handhelds have less processing power than desktops, it has the key advantage of mobile authoring at any place in any time. Currently, Langlotz et al. (2012) draws basic 3D shapes and other features such as copying, deleting, etc.

3.1 Simple In Situ Authoring for Teacher's Use

For the purposes of teachers, it is enough for them to download pictures from the internet, and then place it on a real environment. As such, we implemented an authoring tool that enables teachers to download a picture, and perform affine transformations. Our prototype uses the ARToolkit running on iPad 2 (dual-core A5, 512MB DDR2 RAM, 32GB, 601 grams, 9.7 in display, 1024-by-768 at 132 ppi).

Figure 1 shows the interface for our simple authoring tool for teachers and a sample use case. In this example, teachers can download any image from the internet. This image is converted into a texture on the screen. Using gestures like swipe, pinch, and so on, the teachers can modify the appearance of the image. In this example, it is desirable to scale and position the lungs correctly on the body.

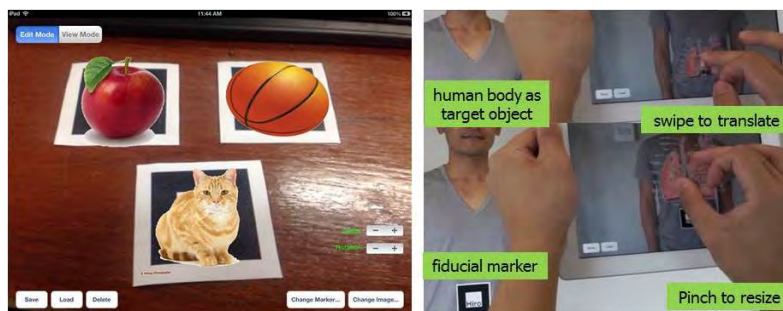

Figure 1. Simple Authoring Tool (left); Sample Use of the Authoring Tool (right)

3.2 Handheld AR Platform for Situated Multimedia

Currently, authoring tools focus on rendering fast and beautiful graphics on a real world scene. There are few authoring tools that emphasize on the use of sounds and text. For educational settings, teachers use a combination of image, sound and text to facilitate learning. As such, we developed a handheld AR platform for presenting images, sound and text onto real objects.

We implemented the whole platform on iOS7 running on iPad 2. Figure 2 shows the package diagram and a sample application for vocabulary learning. The main part of the platform is the Controller, which has access to learning contents. It receives the marker ID and camera view matrix

¹ <https://developer.vuforia.com/>

² <http://developer.pointcloud.io/sdk>

from the Tracker and uses these information to specify the behavior of the on-screen display. The Tracker was built using ARToolkit, and the Renderer was built on OpenGL ES 2.04. In the sample use case, students can learn the word “pindutin” (Filipino for “to push”) by animating a hand which pushes a real button. This is an example of situated multimedia because it shows explicitly the relationship of the animation with real objects such as a coffee maker found in the learner’s natural environment.

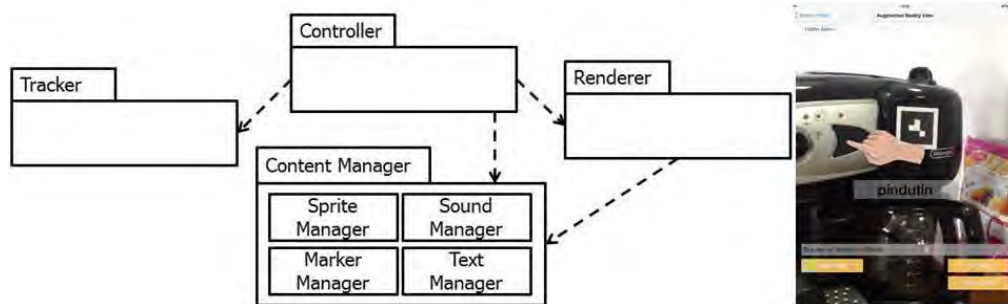

Figure 2. Package diagram of handheld AR platform (left); Sample Interface using the platform (right)

4. Conclusion

We defined augmented reality as situated multimedia. For the first time, we point out that AR could be better understood and designed by applying multimedia learning theory. Aside from graphics, sound and text is also required for creating AR learning materials. As such, we implemented two prototypes for authoring situated multimedia content namely, in situ authoring and our handheld AR platform. Currently, we are conducting evaluations of the interface with teachers. Educators can benefit from this research because it will enable them to design educational content in authentic contexts.

References

- Azuma, R. T. (1997). A survey of augmented reality. *Presence*, 6(4), 355-385.
- Azuma, R., Baillot, Y., Behringer, R., Feiner, S., Julier, S., & MacIntyre, B. (2001, Nov). Recent advances in augmented reality. *Computer Graphics and Applications, IEEE*, 21(6), 34-47.
- Dede, C. (2011). Emerging technologies, ubiquitous learning, and educational transformation. In *Towards Ubiquitous Learning* (pp. 1-8). Springer.
- Herrington, J., & Oliver, R. (1995). Critical Characteristics of Situated Learning: Implications for the Instructional Design of Multimedia. In J. Pearce, & A. Ellis, *Learning with technology* (pp. 235-262). Victoria: University of Melbourne.
- Fujimoto, Y., Yamamoto, G., Kato, H., & Miyazaki, J. (2012). Relation between location of information displayed by augmented reality and user's memorization. *Proceedings of the 3rd Augmented Human International Conference* (pp. 7:1--7:8). New York, NY, USA: ACM.
- Kato, H., & Billinghurst, M. (1999). Marker tracking and hmd calibration for a video-based augmented reality conferencing system. *International Workshop on Augmented Reality, 1999.(IWAR'99)*
- Langlotz, T., Mooslechner, S., Zollmann, S., Degendorfer, C., Reitmayr, G., & Schmalstieg, D. (2012). Sketching up the world: in situ authoring for mobile augmented reality. *Personal and ubiquitous computing*, 16(6), 623-630.
- MacIntyre, B., Gandy, M., Dow, S., & Bolter, J. D. (2004). DART: a toolkit for rapid design exploration of augmented reality experiences. *User interface software and technology*, (pp. 197-206).
- Mayer, R. E. (2009). *Multimedia learning*. Cambridge University Press.
- Santos, M., Chen, A., Taketomi, T., Yamamoto, G., Miyazaki, J., & Kato, H. (2014, March). Augmented Reality Learning Experiences: Survey of Prototype Design and Evaluation. *Learning Technologies, IEEE Transactions on*, 7(1), 38-56.
- Specht, M., Ternier, S., & Greller, W. (2011). Mobile augmented reality for learning: A case study. *Journal of the Research Center for Educational Technology*, 7(1), 117-127.
- van den Hengel, A., Hill, R., Ward, B., & Dick, A. (2009). In situ image-based modeling. *Mixed and Augmented Reality, 2009. ISMAR 2009. 8th IEEE International Symposium on*, (pp. 107-110).
- Wu, H. K., Lee, S. W., Chang, H. Y., & Liang, J. C. (2013). Current status, opportunities and challenges of augmented reality in education. *Computers & Education*, 62, 41-49.

Behavioral Analysis of Learners Using Smart Devices in an Indirect Learning System

Shigeki OHIRA^{a*}

^a*Information Technology Center, Nagoya University, Japan*

*ohira@nagoya-u.jp

Abstract: The main method of learning carried out generally is still direct learning, that is, a method of learning that directly and actively focuses on the object of learning. We call indirect learning the learning of a subject matter indirectly as a result of having actively studied another subject matter. We have aimed to establish the information technology required to put indirect learning into practice. This research deals with the behavior of system users when they use smart devices and realize indirect learning in implementing a task. We report results based on analysis of notebooks and videos recorded at the time of learning.

Keywords: Indirect learning, smart devices, face-to-face communication, user analysis

1. Introduction

In his book, *The Last Lecture* (Pausch and Zaslow, 2008), Pausch said that when we learn something we should not learn it directly: instead he emphasized indirect learning in which learning proceeds indirectly by focusing on another object. However, even today, the type of learning normally carried out is direct learning. Until now proposals have also been made on indirect learning (Adler, 1993). Still, it has been difficult to make a quantitative evaluation of indirect learning itself, and there are almost no examples of the achievement of practical indirect learning. In this study, we introduced a face-to-face meeting support system (Ishitoya et al., 2012) for a small number of people. This system uses tablet devices and large displays as a practical indirect learning system that makes use of information technology. We report on indirect learning in task implementation in English language education.

2. Indirect Learning Systems using Smart Devices

2.1 System Overview

In indirect learning systems, as shown in the processes of indirect learning in Figure 1, it is necessary to carry out support for both individual indirect learning (through investigations, thought, and organization) and indirect learning within a group (through discussions and organization.) We developed and operated a face-to-face meeting support system. This system is composed of two parts. The first part, called the Time Machine Board (hereafter TMB), is a framework for recording the content of meetings. The second part, called iSticky, is client software for collecting content related to individual activities and inputting information into the TMB. TMB uses a large display as a computerized whiteboard, and iSticky is operated by a tablet device (iPad).

2.2 Use in Individual Learning

iSticky has two functions. One of them is to act as a log that records and controls individual daily learning activities. The other is link to an informationally expanded TMB and act as a user interface that presents part of the learning log on a large display. We assumed that the iSticky would be carried around by learners in their daily activities. The learning log recorded on an iSticky can be saved on an indirect learning cloud connected with a network.

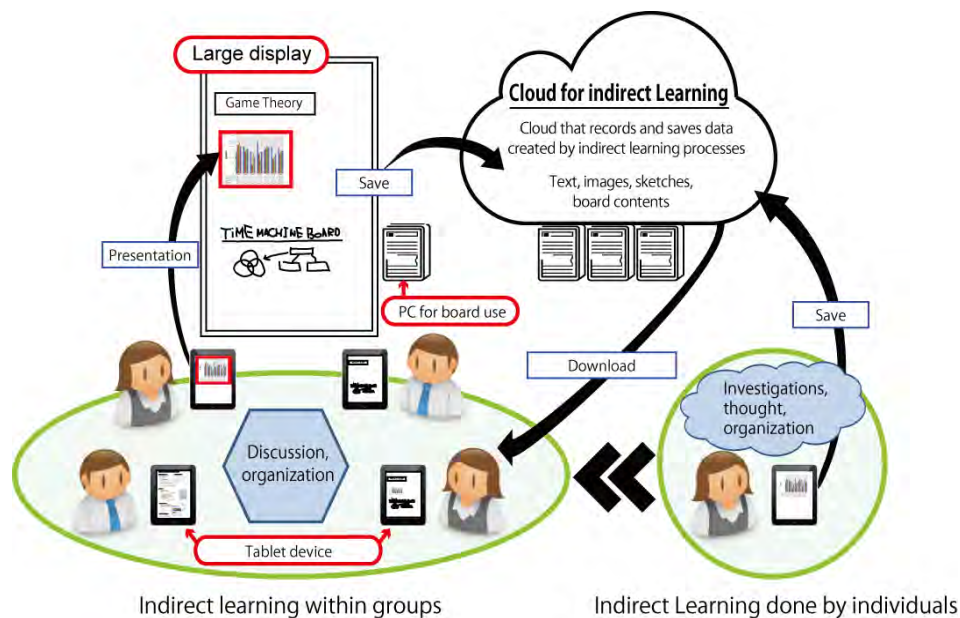

Figure 1. Indirect learning processes.

2.3 Use in Group Learning

There are some studies concerning the mixed use of mobile devices, shared displays, and cloud services (Liu et al., 2009; Jansen et al., 2013). In indirect learning carried out by small groups, students can hold discussions among themselves while they organize and present to other learners some of their ideas, thoughts, and results, which they investigated in their daily activities by using TMB and iSticky. The TMB is composed of a large display and a single PC. With iSticky, individual learning logs such as sketches, images, and text that are stored on a cloud for indirect learning can be transferred to a PC and presented on a large display. With the iSticky board tab, learners can confirm the content displayed on the TMB. They can copy part of the learning log onto the board tab, and by moving, enlarging, or reducing the elements on the board, they are able to manipulate the information presented on the TMB.

3. Collection of Indirect Learning Data

We used this system for indirect learning in which students carried out a task using graded readers, and we collected indirect learning data. The participants were ten second-year university students (9 males, 1 female). TOEFL ITP scores ranged from a high of 620 to a low of 450, with a mean of 510. We first divided the students into small groups of five members. Then we gave the students this indirect learning assignment: “Decide on a theme from any branch of knowledge that you like. Then create a poster that will communicate in an easily understandable way the history, the current situation, and the future of this branch of knowledge.” As material for the students to refer to when doing their assignment, we designated books from the Oxford University “A Very Short Introduction” series as graded readers. We divided implementation of the task into five phases: (i) selection of a theme and assignment of roles (ii) report on investigations (iii) design of posters (iv) presentations and (v) feedback meetings. We made use of an indirect learning support system in the discussions and operations of each phase.

4. Analysis of Indirect Learning Processes

We analyzed the recorded data of operations and of discussions of learners among themselves during indirect learning. We analyzed this data in terms of whether indirect learning systems based on TMB and iSticky were used or not. When these systems were not used, whiteboards and posters were used instead of a large display, and paper notebooks were used instead of tablet devices.

4.1 Analysis of Notebooks and Posters

As a result of comparing the number of characters written in notebooks for each page in the extensive reading text, there was almost no difference between the iSticky and the notebooks, but the number of English words was 2.2 times greater in the iSticky than the notebooks. Furthermore, when the number of characters presented on the whiteboards was compared in terms of time, the rate was 2.9 times more for the TMB than for the whiteboard. Regarding the number of characters on the posters, the TMB had about 11% more, and the time required for making the poster was about 52% less. From the above, we found that when this system was used during a limited time period, it was able to present information efficiently. As a result, more time could be used for communication such as discussions.

4.2 Use of Video Data to Analyze Verbal and Non-verbal Information

We used ELAN to provide annotations to the video data for indirect learning processes. Specifically, we wrote out the content of conversations as verbal information, and we analyzed and recorded eye direction and nodding as non-verbal information. Consequently, the number of characters included in statements per unit of time was about two times greater when smart devices were used. When smart devices were used instead of posters, listeners tended to nod more and have better eye contact with the speaker. The result was that in the discussions immediately after the presentations, we found that groups using the smart devices were asked more questions.

4.3 Questionnaire Survey

Through the whole task of making a poster, we had the learners evaluate, then we found that groups using smart devices had higher evaluations on the understandability of the poster and on the degree of satisfaction with the discussion. We asked the students about any skills other than presentation skills they felt they obtained. Regardless of whether the students used or did not use the indirect learning system, they gave answers such as communication skills overall, ability to impart what I want to say, cooperation, and ability to summarize. Furthermore, students using the system said they improved their ability to create a consensus, their powers of comprehension, and their ability to discuss and debate.

5. Conclusion

We analyzed the behavior of system users when they realized indirect learning through implementation of a task with smart devices. As a result, we found that tablet devices were highly efficient in the presentation of information and more time could be used for communication activities such as discussions; furthermore, we learned that the degree of satisfaction in carrying out the task was higher for those using the system. On the other hand, we learned that there was a trade-off between the redundancy of tool operation and the re-usability of information.

Acknowledgements

This work was supported by JSPS KAKENHI Grant Number 24650552.

References

- Pausch, R. & Zaslow, J. (2008). *The Last Lecture*, New York: Hyperion.
- Adler, J. E. (1993). Indirect learning and the aims-curricula fallacy, *Philosophy of Education*, 27(2), 223-232.
- Ishitoya, K., Ohira, S., Nagao, K. (2012). A continuous meeting support system, *IPSJ Journal*, 53(8), 2044-2048.
- Liu, C.-C., Chung, C.-W., Chen, N.-S., & Liu, B.-J. (2009). Analysis of peer interaction in learning activities with personal handhelds and shared displays. *Educational Technology & Society*, 12(3), 127-142.
- Jansen, M., Bollen, L., Baloian, N., & Hoppe, H. U. (2013). Using cloud services to develop learning scenarios from a software engineering perspective. *Universal Computer Science*, 19(14), 2037-2053.

Development of a Mobile Visualization Application for Constructivist Learning and Assessment in Science

Hsin-Yi CHANG^{a*}, Yuan-Tse YU^b, Jung-Yi HUNG^a & Kao-Chi HSU^a

^a*Graduate Institute of Science Education and Environmental Education,
National Kaohsiung Normal University, Taiwan*

^b*Department of Software Engineering, National Kaohsiung Normal University, Taiwan*

*hsinyichang@nknucc.nknu.edu.tw

Abstract: In this paper we introduce a newly developed application for Android tablets that is designed based on the perspectives of constructivist learning and scientific modeling and representation. The purpose of this designed product is to facilitate visualization instruction and assessment in science class. We conducted an initial evaluation study for usability tests and investigated how case users from scientists, teachers, advanced learners and novice learners may use the tool to support their visualization of the concept of carbon cycling. Different patterns of use were identified for further research and tool development.

Keywords: Mobile technology, visualization, constructivism, science learning, assessment

1. Introduction

Visualization involves important practice for communities of scientists, engineers and many other professional experts (National Research Council [NRC], 2011). Visualization refers to processes of creating multiple representations, making meaning of and interacting with the representations (Gilbert, 2008). In light of education, students' ability to visualize or draw their ideas about certain phenomena and to use their visualizations to understand science concepts is important in terms of science education goals and 21st century knowledge and skills (NRC, 2012). Moreover, asking students to draw their ideas can be an effective teaching strategy since it follows the constructivist perspective that learning occurs when learners try to integrate existing and new information to form their own conceptual framework (Ainsworth, Prain, & Tytler, 2011; Linn, 2006).

There are numerous mobile applications available for the purpose of making digital drawings. However, while many applications allow drawing in general, we have not found any current mobile application that provides science content related functions and supports, which are important for students to make drawings efficiently and with scaffolds to benefit science learning (Quintana et al., 2004). For example, ChemSense (Schank & Kozma, 2002) and Chemation (Chang & Quintana, 2006; Chang, Quintana & Krajcik, 2010) provided built-in atom pallets and connection bonds for students to make digital drawings and animations to represent their ideas of chemical phenomena. Research has shown that students benefit from content specific functions to make their drawings to learn science (Chang & Quintana, 2006). However, neither application can operate on the Android system. Also, they only support students in making drawings of atoms and molecules, representing ideas at the particulate level. In this study we describe our efforts to develop a new mobile application for Android tablets, DrawScience, that allows students to visualize their ideas, not only at the particulate level, but also at the symbolic, systematic, and macroscopic levels, as these levels of representation are all essential elements for visualization of science phenomena and concepts. Currently DrawScience is designed as a formative assessment tool that can be seamlessly integrated in science class to make students' ideas explicit and accessible, and for teachers to learn from students' ideas to improve teaching and learning. Future research includes possibilities of automatic scoring of

visualizations, real-time feedback for the making of visualizations, and collaborative construction of visualizations to spur discussion during the poster presentation.

2. The Mobile Application: DrawScience

The design of the application is based on the constructivist perspective that students' existing ideas are building blocks for their later learning (Linn, 2006). The interface is divided into three main areas (Figure 1, left) to allow students expressing their ideas: question, drawing and animation. During class, teachers can use an e-learning platform to type in their question for students; students respond to the question by using the features in the application to construct visualizations to make their thinking visible. The design of the four modes (Figure 1, middle) is based on the perspective of scientific modeling and representation that indicates four types of representation that are essential in science teaching and learning: particulate, symbolic, systematic, and macroscopic (Gilbert, 2008; Lehrer & Schauble, 2006). The four modes including the free drawing, textual, particulate, and link modes, enable users to draw the four types of representations in their visualization. In addition, users can use the animation function to create flipbook-style animations to represent a dynamic process in their visualization.



Figure 1. Screenshots of DrawScience: Left: the interface includes three major areas - question, drawing, animation; Middle: four modes - free drawing, textual, particulate, and link modes Right: an example drawing made using DrawScience

3. Evaluation of the Application

We interviewed a total of 16 participants to investigate how they used the tool to visualize their understanding of the concept of carbon cycling. We chose to focus on the topic of carbon cycling since it involves important science concepts within biology and across other subject areas such as earth and environmental sciences. Also, visualizing the carbon cycle involves the use of dynamic and multiple representations at particulate, symbolic, textual, systematic and macroscopic levels. We interviewed four cases from each of the distinct groups, biologists, biology teachers, 12th-grade students (who had already learned carbon cycling) and 10th-grade students (who had not yet learned carbon cycling), aiming to test the maximum variety of possible patterns of uses with the visualization tool. Each interview lasted about two hours, and consisted of five major questions asking the participants to make a total of five drawings or animations to show their ideas related to carbon cycling.

Overall the interview results indicate that all participants were able to construct their visualizations and animations of carbon cycling using DrawScience, while participants from different groups seemed to show different patterns of use. To further discern the patterns, we developed a coding framework to analyze the quality of the participants' visualizations (Table 1). We identified four aspects of visualizations emergent from the data, and developed detailed scoring rubrics to rate the participants' drawing in the four aspects: the use of animation, multiple representation, scientific concept and visualization strategy. We found that both the biologist and biology teacher groups scored higher than the students in representing more scientifically appropriate propositions and relationships of the concepts in their visualizations. The biology teachers seemed best at using multiple representations, probably due to their expertise in teaching in which multiple representations are often needed to help students learn the concepts. Interestingly, the students seemed as good as the scientists in terms of using visualization strategies. All participants created three to four frames to formulate an animation showing the directionality and continuity of a dynamic process of plant growth.

Table 1: A coding framework to analyze the quality of the participants' visualizations in four aspects.

Aspect	Definition
Use of animation	Participant created multi-frame animation to show the directionality and continuity of a dynamic process.
Use of multiple representations	Participant used the modes in the tool to create textual, symbolic, macroscopic, and particulate levels of representation.
Use of scientific concepts	Participant represented scientific concepts appropriately including propositions and relationships of concepts.
Use of visualization strategies	Participants used visualization strategies including use of color, zoom-in and zoom-out, and animation techniques.

4. Concluding Remarks

The results of the initial evaluation study indicate that for science learners the design of the visualization tool needs to embed supports in the aspects of appropriately using scientific concepts and multiple representations; for teachers, a reminder to use visualization strategies and for scientists, a reminder to use multiple representations might help. However this tendency of patterns we observed needs further tests with a larger sample size. Nevertheless the application enables scientific visualizations and we are working on providing automatic scoring, real-time feedback, and collaborative construction functions.

Acknowledgements

This material is based upon work supported by the Ministry of Science and Technology, Taiwan, under grant NSC102-2628-S-017-001-MY3. We would like to thank all the people who were involved in the development of the application and preparation of the paper.

References (Selective)

- Ainsworth, S., Prain, V., & Tytler, R. (2011). Drawing to learn in science. *Science*, 333, 1096-1097.
- Gilbert, J. K. (2008). Visualization: An emergent field of practice and enquiry in science education. In J. K. Gilbert, M. Reiner & M. Nakhleh (Eds.), *Visualization: Theory and practice in science education* (Vol. 3, pp. 3-24). Dordrecht, Netherlands: Springer.
- Lehrer, R., & Schauble, L. (2006). Cultivating model-based reasoning in science education. In K. Sawyer (Ed.), *Cambridge handbook of the learning sciences* (pp. 371-388). Cambridge, MA: Cambridge University Press.
- Linn, M. C. (2006). The knowledge integration perspective on learning and instruction. In R. K. Sawyer (Ed.), *The Cambridge handbook of the learning sciences* (pp. 243-264). New York: Cambridge University Press.

Educational Affordances of Smart Learning Applications in Science Education

Young Hoan CHO ^{a*}, Hyunyoung LEE ^a, Mirye OK^a, Namsoo SHIN^b, Eun Jung KOH ^a,
Changyoun LEE ^a, Dae Hong JEONG ^a

^aCollege of Education, Seoul National University, South Korea

^bSchool of Education, University of Michigan, U.S.A.

*yhcho95@snu.ac.kr

Abstract: Science educators have made efforts to design and use educational applications of smart devices for meaningful learning. For the design of *smart learning* environments, it is crucial to understand the affordances of educational applications as well as their limitations. This study analyzed 40 applications according to their educational affordances: information acquisition, inquiry, modeling, and collaboration. Characteristics of smart learning applications were described along with specific examples. More efforts are needed to design smart learning applications for collaboration and to overcome the limitations of existing applications.

Keywords: Educational affordance, smart device, application, science education

1. Introduction

A growing number of educators have paid attention to the use of smart devices that promote ubiquitous learning in formal and informal settings. In South Korea, the government has encouraged Self-directed, Motivated, Adaptive, Resource-enriched, and Technology-embedded learning (i.e., SMART learning). In addition, global enterprises like Apple, Google, and Samsung have invested a lot in the development of educational applications for smartphones and tablet PCs. For the design of meaningful learning with smart devices, it is necessary to understand educational affordances of smart learning applications. Educational affordances indicate the properties of an artifact that enable a particular action for learning and teaching (Gibson, 1977; Tan et al., 2012). Some educational applications are more likely to facilitate constructive or collaborative learning activities than others that focus on delivering new information and knowledge. It is crucial for educators to select and use smart learning applications that have educational affordances closely related to learning objectives. Thus, this study intends to explore educational affordances of smart learning applications in science education.

2. Meaningful Learning in Science Education

Science educators recently emphasized inquiry, modeling, and collaborative learning for meaningful learning rather than knowing scientific information and facts. In inquiry-based learning, students are engaged in creating hypotheses, conducting experiments, and explaining collected evidence. These activities help students to develop an in-depth understanding of scientific principles and scientific literacy in authentic contexts. Students who participate in scientific inquiry are likely to be motivated through authentic activities and develop positive attitudes toward science (Ahmed & Parsons, 2013). In addition, modeling is an essential practice in science education because a lot of scientific knowledge consists of models of scientific phenomena. Student-constructed models explicitly show what students understand and what misconceptions they have. Through iterative modeling activities, students can explain causal relationships behind observed scientific phenomena qualitatively as well as quantitatively (Louca et al., 2011). The inquiry and modeling activities are often conducted in a small group because collaborative discourse helps students to perceive multiple aspects of a scientific phenomenon and develop argumentation skills to support their hypothesis with evidence and scientific knowledge. Students can develop more valid explanations by integrating diverse ideas and challenging

each other. Thus, in science education, smart learning applications should have affordances to enable inquiry, modeling, and collaboration activities for meaningful learning.

3. Methods

Science education applications, which work in smartphones and tablet PCs using Android as an operation system, were searched in “Google Play Store” in October 2013. Initially 163 applications were identified with keywords of chemistry, biology, physics, earth science, and science education. Two graduate students in science education and one secondary school teacher collaborated to exclude redundant applications and select applications that were closely related to K-12 science education on the basis of Korea National Science Curriculum. As a result, 40 applications were selected for analysis. Through constant comparison and discussion, the three researchers grouped the smart learning applications into *information acquisition*, *inquiry*, *modeling*, and *collaboration* according to their educational affordances. They analyzed which learning activity was closely related to the properties of a smart learning application. The data analysis process was constantly monitored and coached by two professors in the college of education.

4. Findings

According to educational affordances, the 40 applications of science education were categorized into information acquisition, inquiry, modeling and collaboration as shown in Figure 1. Smart learning applications for inquiry and modeling were as many as those for information acquisition. However, the number of applications to promote collaboration was much smaller than others. More attention should be paid to develop smart learning applications to enable students to share their different viewpoints and collaboratively build knowledge

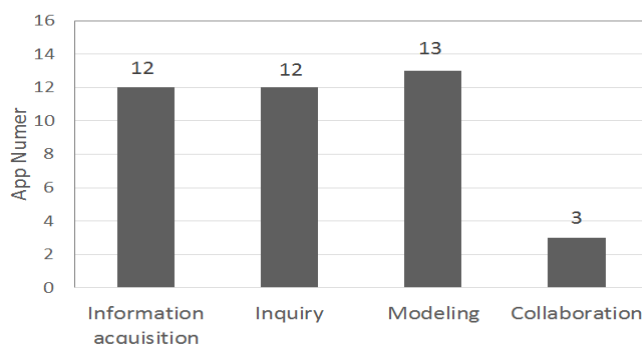

Figure 1. Number of smart learning applications according to educational affordances

Applications of information acquisition enabled students to memorize facts and concepts included in the science education curriculum and to have access to educational resources in the Internet. The applications included the content of a textbook, which allowed students to prepare and review lessons anywhere and at anytime. For instance, the application of “Periodic Table Quiz” helped students to memorize the location of atoms through simple quizzes. However, this kind of applications had limitations in supporting higher-order thinking skills and social competencies.

Inquiry applications enabled students to collect and analyze data with smart devices in and out of school. Students were able to record audio and visual information and to measure the angle, length, height, or temperature of an object. The applications were helpful in observing scientific phenomena and collecting data for scientific inquiry in real world contexts. For instance, the application of “Smart Measure” enabled students to easily measure the distance and height of a target in a smartphone screen by trigonometry. However, we could not find an application that supported a whole process of scientific inquiry (e.g., prediction, observation, and explanation).

Modeling applications visualized scientific concepts and objects (e.g., molecular structure) that could not be observed in everyday lives. The applications allowed students to explore a 3D model from

multiple directions and to interact with the model through the touch screen of a smart device. The application of “3D Brain,” for example, enabled students to explore the function of each brain region by rotating and zooming around a 3D brain model. Despite the benefits of the applications, they had limitations in encouraging students to iteratively create and modify their own models of scientific phenomena.

Information Acquisition:
Periodic Table Quiz

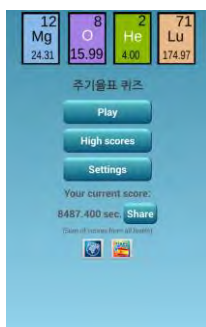

Inquiry:
Smart Measure



Modeling:
3D Brain

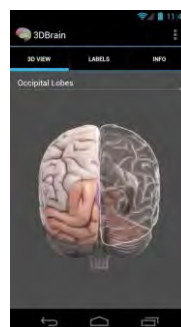

Collaboration:
ISS Detector



Figure 2. Examples of smart learning applications

Lastly, collaboration applications encouraged students to collaboratively collect data and share their opinions on findings. The applications can support not only discussion in a classroom but also online discussion among students in different schools and regions. For instance, the application of “ISS detector” allowed students not only to get information of the international space station and iridium flares but also to share their insights through social network service (SNS). Despite the potential of smart devices for collaborative learning, there were few science education applications that focus on collaboration. More efforts are needed to apply smart devices for collaborative argumentation and knowledge building in science education.

5. Conclusion

Smart learning applications have diverse affordances to facilitate meaningful learning in science education. This study explored educational affordances of the applications in terms of information acquisition, inquiry, modeling, and collaboration. More attention should be paid to the development of smart learning applications that support meaningful learning in science education. Particularly, more smart learning applications are needed to enable students to share their viewpoints of a scientific phenomenon and collaboratively carry out a scientific task. In addition, future research is suggested to investigate educational affordances of smart learning applications in other sources (e.g., Apple Store) and domains. It is also necessary to carry out developmental studies to overcome the limitations of smart learning applications and to optimize educational affordances of smart devices. The study of educational affordances will contribute to the design of meaningful learning environments that help students to develop key competencies necessary in the 21st century.

References

- Ahmed, S., & Parsons, D. (2013). Abductive science inquiry using mobile devices in the classroom. *Computers & Education, 63*, 62-72.
- Gibson, J. J. (1977). The theory of affordances. In R. Shaw & J. Bransford (Eds.), *Perceiving, acting, and knowing: Toward an ecological psychology* (pp. 67-82). Hillsdale, NJ: Lawrence Erlbaum Associates.
- Louca, L. T., Zacharia, Z. C., & Constantinou, C. P. (2011). In quest of productive modeling-based learning discourse in elementary school science. *Journal of Research in Science Teaching, 48*(8), 919-951.
- Tan, T.-H., Lin, M.-S., Chu, Y.-L., & Liu, T.-Y. (2012). Educational affordances of a ubiquitous learning environment in a natural science course. *Educational Technology & Society, 15*(2), 206-219.

Evaluation of Using a Tablet Device for a School Trip

Norio SETOZAKI^{a*}, Mai OKUDA^b, Yusuke MORITA^c

^a*Faculty of Education, Nagasaki University, Japan*

^b*Faculty of Economics, Kanagawa University, Japan*

^c*Faculty of Human Sciences, Waseda University, Japan*

*setozaki@nagasaki-u.ac.jp

Abstract: A tablet device can help solve various problems such as shortening the time of pre- and post-learning activities and remedying the problem of unavailability of a personal computer room. Therefore, this research examines how a tablet device can be effectively used for various learning phases in a school trip. The results show that the use of a tablet device is helpful during the pre-learning phase of a "Famous-place Investigation" and in the use of data obtained in this phase and information sharing during the experiential activities. In addition, this study reveals that the use of a tablet device to present an augmented reality poster is effective.

Keywords: Tablet Device, School Trip, Augmented Reality, Practical Class

1. Introduction

When planning a school trip, various problems may emerge such as securing the time required for pre- and post-learning activities. Moreover, to deepen the learning experience, in many cases, personal computers (PCs) are used for collecting information. However, availability of a PC room may be limited, especially in larger schools.

On the other hand, information and communications technology (ICT) have been utilized for learning activities, such as a school trip, to secure safety and improve the learning effect (Kasahara et al., 2013, Sato et al., 2010). Thus, a tablet device is an example of how ICT equipment has been increasingly put to practical use in schools (Hasegawa et al., 2010), and from the perspective of mobility and user interface, such a device has been deemed effective in various applications (Savilla, 2010).

By utilizing the functions of a tablet device, experiential learning activities at a selected location on a school trip as well as pre- and post-learning activities can be accomplished by a single device. For example, if the Internet is available, then information regarding the location or attraction can be obtained using a tablet device as a pre-learning activity, even if a PC room is not available. In addition, by saving such data on a tablet device and utilizing the information during the visit, work can become more efficient, especially under the time restraints of the pre-learning phase. With regard to post-learning activities, the still images and animations obtained from the location can be saved on the device and used for subsequent presentations. Therefore, in this study, a tablet device was employed for a school trip during the pre-learning phase, the experiential activities at the location, and the post-learning phase in order to evaluate its overall effectiveness for such educational activities.

2. Method

2.1 Use of a Tablet Device

A tablet device (Apple iPad2) was used on a school trip for second-year students at a junior high school. Moreover, as shown in Fig. 1, the tablet device was used during the pre-learning phase, the experiential activities at the location, and the post-learning phase. In the pre-learning phase, the famous place that was selected for visiting, the traffic schedule, and the map were investigated; this digital data was saved

on the tablet device. In the experiential activities, the tablet device was used for viewing the aforementioned digital data, information sharing with other groups, creating the activity report (using a TV phone), and producing the still images and animation used in the presentation for the post-learning phase. In this final phase, an augmented reality (AR) poster was produced as a learning tool and the photographs taken by the students of each group were attached to the sightseeing map and printed in A1 size. In this case, if the tablet device is held up by making the photograph into an AR marker, then the animation recorded during the experiential activities will be displayed on the marker.

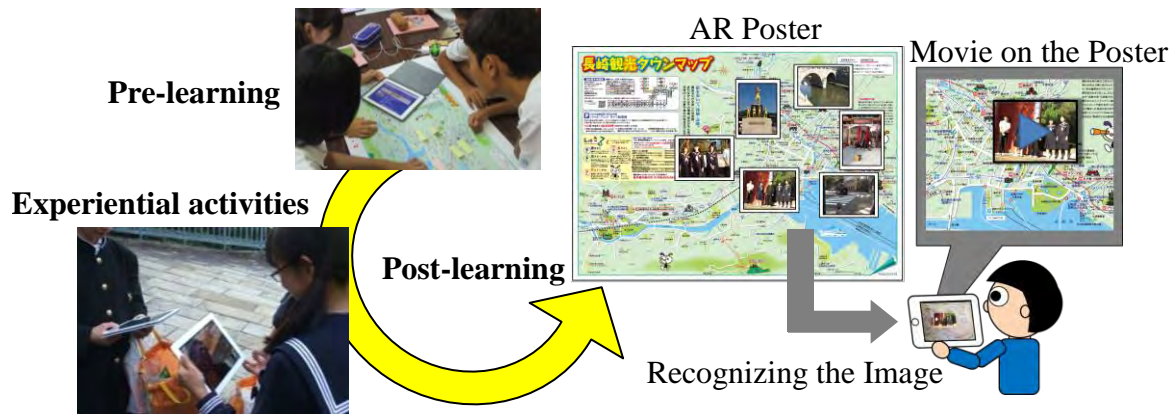

Figure 1. Use of a Tablet Device

2.2 Subjective Assessment by Survey

Evaluation of the use of a tablet device was obtained from the 99 students who participated in the pre-learning and experiential activities. The question items regarding interest and usefulness of the pre-learning activities included "Theme Arrangement," "Famous-place Investigation," and "Presentation." Moreover, the question items concerning the experiential activities were "Usefulness of Famous-place Data," "Interest in Photographs by Other Groups," "Usefulness of Map Data," "Interest in the TV Phone," and "Interest in the Report." The question items regarding the AR poster included "Interest (AR poster was interesting)," "Usefulness (AR poster is useful for presentation)," and "Motivation (I would like to produce AR poster next time also)." Finally, evaluations were performed by 188 students (comprising first and third graders who have not previously participated in a school trip), 19 teachers, and 76 parents.

3. Results and Discussion

Regarding the use of the tablet device in the pre-learning and experiential activities, students responded by selecting either "strongly agree," "agree," "disagree," or "strongly disagree" for each question. The point scores were 4, 3, 2, and 1, respectively. The mean value of the points in each category was then calculated and analyzed using analysis of variance (ANOVA). In addition, multiple comparisons were made using the Holm method.

Figure 2 presents the results of the evaluation for the pre-learning activities. Regarding interest, "Famous-place Investigation" received the highest evaluation, which was followed by "Theme Arrangement" and "Presentation" ($F(2,190) = 31.87, p < .01/MSe = 0.30, p < .05$). Moreover, regarding usefulness, "Famous-place Investigation" obtained the highest evaluation, which was followed by "Presentation" and "Theme Arrangement" ($F(2,190) = 15.64, p < .01/MSe = 0.35, p < .05$). Thus, the findings show that using a tablet device was useful for these activities.

Figure 3 shows the results of the evaluation concerning the experiential activities. "Usefulness of Famous-place Data," "Interest in Photographs by Other Groups," and "Usefulness of Map Data" obtained a higher evaluation than "Interest in the Report" ($F(4,208) = 5.30, p < .01/MSe = 0.51, p < .05$). Therefore, the data obtained by the pre-learning activities and information sharing with the others was useful for these activities.

Figure 4 reveals the results of the evaluation of the AR poster. According to the responses, the participants were not concerned with the subject's attributes, and at least 90% answered in the affirmative for all questions. Therefore, using a tablet device to present the AR poster was useful.

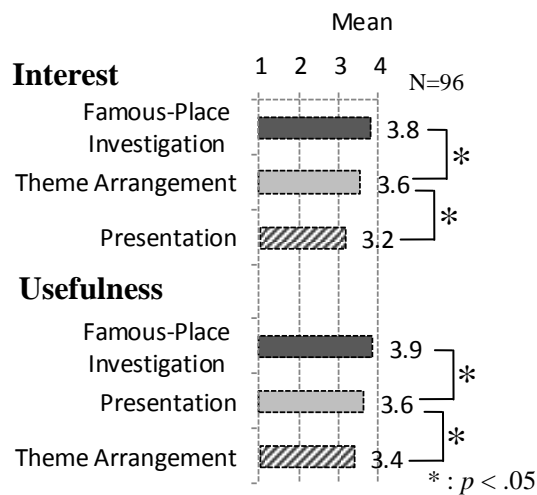

Figure 2. Results of the pre-learning activities

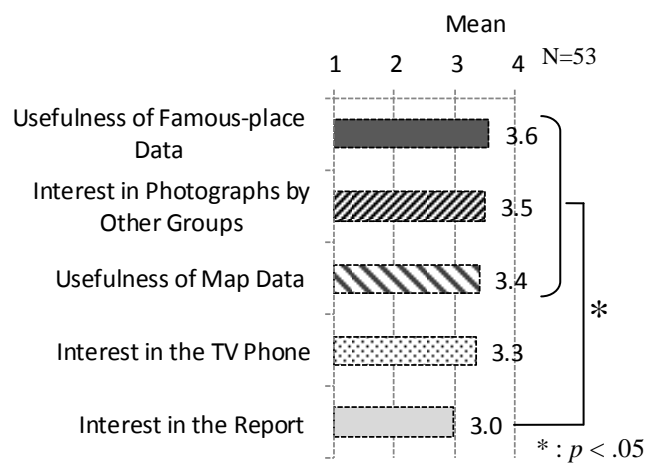

Figure 3. Results of the experiential activities

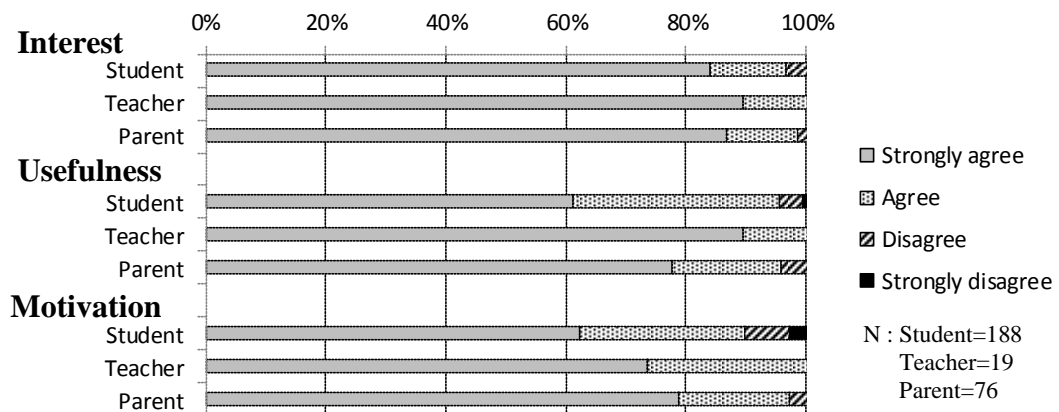

Figure 4. Results of the post-learning activities

4. Conclusion

This study evaluated the usefulness and practicality of a tablet device for a school trip during the pre-learning, experiential activities, and post-learning phases. The results of the evaluation show that using a tablet device during the pre-learning phase of a "Famous-place Investigation" was useful and that the data obtained during this phase and information sharing with others was also useful during the experiential activities. Furthermore, the results reveal that the use of a tablet device to present the AR poster was effective. Although the findings of this study show the effectiveness of such a device for the various learning phases of school trips, further investigation should be conducted regarding its learning effect and usefulness in other situations.

References

- Hasegawa, S., Sahara, O., Hasegawa, A., Tagawa, T., Ozaki, S. (2010). Use of Tablet Terminals in Education: Introduction of iPad to Nagoya Bunri University, *Journal of Human Interface Society*, 12(4), 245–252.
- Kasahara, H., Mori, M., Mukunoki, M., Minoh, M. (2013). Business Model of Mobile Service for Ensuring Students' Safety Both in Disaster and Non-disaster Situations during School Trips, *Information and Communication Technologies in Tourism 2014*, 101–114.
- Sato, Y., Harada, Y., Kojima, M., Kusunoki, F. (2010). An experimental trail for connecting museum resources and the city, *The 34th Annual Meeting of JSSE*, 159–160.
- Savilla, B. (2010). Integrating the iPod Touch in K-12 Education: Visions and Vices. *Computers in the Schools*, 27(2), 121–131.

Features of Creating Flash Card Materials for Reflecting on Learned Contents

Shin KURATA^{a*}

^a*Faculty of Education, Nagasaki University, Japan*

*shin1222kurata@nagasaki-u.ac.jp

Abstract: It is important that reflecting on contents learned during a class is done at the end of each class. However, it is difficult for many to invest in the human cost in time to prepare for such reflection time. This research suggests creating flash card materials using pictures that teachers have taken during class to reflect on different elements of the class. This study introduces the Skitch application tool as a useful application for providing reflection scenes of the class to students belonging to the Graduate School of Education. The tool was evaluated according to its availability during class and from the perspectives of “learning content,” “notes,” and “creativity” in a descriptive questionnaire. Results revealed that Skitch is a tool that can utilize flash card materials created at an earlier time in the class. The study also reveals features of creating and using flash card materials taken during class.

Keywords: ICT, Reflection, Flash Card Material, Materials development, Skitch

1. Introduction

It has become possible to reflect on the contents of a class using different types of multimedia, such as video, with advances in Information Communication Technology (ICT). However, there are issues about Reflection of class use video by Many cost about human and time (KONNO et al. 2009). Empirical research into the use of ICT to reflect on class material focuses on using video(MURAKAMI et al. 2010). Such research has neglected the use of other types of technology in the class. It is important that students reflect on the contents of the class before they forget the class. Therefore, reflecting on class content must be done quickly at the end of every class. Thus, using materials such as flash card materials (FCMs) by taking pictures of scenes during the class by the teacher is a valid form of content reflection. Takahashi (2011) defines FCMs as digital material used to repeatedly present questions quickly as a “Flash Card.” There are also several different types of activity associated with the use of FCM, such as 1) Reading the word written, 2) Giving the name of a picture, figure or symbol, 3) Answering a quiz with three choices, 4) Giving a “yes” or “no” answer, 5) Filling in the blank. Therefore, it can be said that FCMs are still a tool used most frequently in questioning. However, sometimes the target of questioning is unclear because of the large amount of information that can be contained in one still image, particularly if the FCM is a photo which has inserted a shape such as an arrow to clearly depict the target in question. In doing so, it can create FCMs for reflecting scenes from the class. If necessary, it is also possible to take pictures and insert a shape such as an arrow during class. Therefore, advantages are in reducing planning time as much as possible, and ease of operation.

This study focuses on the Skitch application, which has a reputation for speed and simplicity of photo manipulation. Because, Skitch is one of tools which can shoot and modify easily and quickly. This study reveals the possibility of creating practical FCMs in Skitch. In addition, it reveals the features of creating scenes as FCMs with Skitch.

2. Survey-1 : Whether the practical use of Flash Card Materials

2.1 Survey Methods about Whether the practical use of Flash Card Materials

Figure 1 demonstrates that Flow about FCMs by Skitch for Reflection to Learning Contents. The time taken in creating FCMs in Skitch was investigated, as well as the possibility of practically creating FCMs by Skitch in Survey-1. A questionnaire survey was conducted in which 19 teachers of elementary schools were assessed for the duration taken to create FCMs using Skitch in class. Questions in the survey included the maximum allowable time for the creation of FCMs (Stoppable time). This questionnaire is in a description format. The duration taken to create several different images in Skitch was measured: 1) The duration to take a photo, 2) The duration needed to take a picture and add an arrow, 3) The duration to take a picture and add a mosaic, 4) The duration to take a picture, add an arrow and mosaic. Participants in this part of the study were graduate students of 16. The experiment consisted of taking and editing photographs of four character idiomatic compounds that were written onto a whiteboard. Equipment used in the experiment included a tablet PC with Windows8 installed. The creation time of a flash card was calculated as being the time between pushing the shutter button in Skitch and pushing the save button.

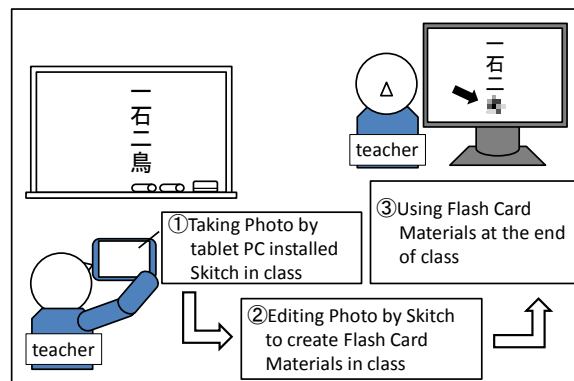

Figure 1 : Flow about Flash Card Materials by Skitch for reflection to learning contents

2.2 Survey Results about Whether the practical use of Flash Card Materials

Figure 2 show the relationship between the number of people and length of stoppable time which teachers think. Results into the average speed of creating a flash card was 112.1 seconds (SD: 70.6). The maximum amount of time taken was 300 seconds, whereas the quickest time was 30 seconds. Results into the amount of time to create an FCM in Skitch were as follows: 1) The average time of taking a picture was only 10.6 seconds (SD: 2.8), 2) The average time of taking a picture and adding an arrow was 13.7 seconds (SD: 3.5), 3) The average time of taking a picture and adding a mosaic was 13.6 seconds (SD: 3.7), 4) The average time of taking a picture, adding an arrow and mosaic was 14.7 seconds (SD: 3.8). In addition, the maximum time taken to create a picture in variable 4 (taking a picture, adding an arrow and mosaic) was 26.0 seconds 2,3,4 in four pattern was creating works of FCMs due to works including to edit ware 2,3,4 in four pattern. The average time across all four variables for creating FCMs was 14.0 seconds. Therefore, the time it takes to create an FCM in Skitch is an average of 14.0 seconds, with a maximum of 26.0 seconds. However, this does not consider the time spent on set up and troubleshooting before and after the pictures are taken.

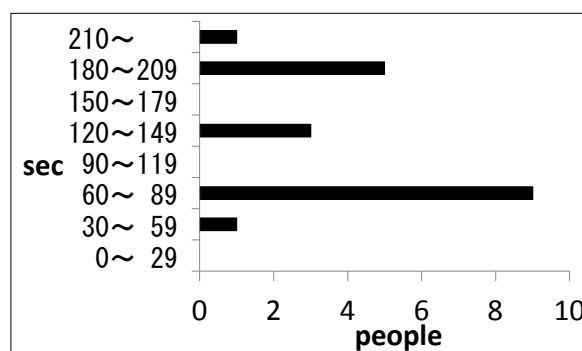

Figure 2 : Relationship of the number of people and stoppable time

3. Survey-2 : Feature for creating scene of Flash Card Materials by Skitch

3.1 Survey Methods about Feature for creating scene of Flash Card Materials by Skitch

A survey was conducted to reveal the features of creating FCMs on Skitch in Survey-2. This questionnaire is in a description format. This survey's participants were the same graduate students who participated in the investigation in Survey-1. There were 17 questions included in this data because one question was added regarding the subject of the survey. The contents of this questionnaire survey included questions such as; 1) "What do you think about the types of lesson contents that can be used?," 2) "What do you think about the notes provided when the flash cards were created?," and 3) "What do you think about the notes provided when editing?." Furthermore, the questionnaire was organized to categorize the information obtained in the questionnaire.

3.2 Survey Results about Feature for creating scene of Flash Card Materials by Skitch

The survey was conducted in the form of a questionnaire following the description format found in Survey-2, and the results were categorized in the same manner. For example, in question 1) "What do you think about the type of lesson contents that can be used?," results were classified into three groups; "passive," "active," and "experience." There were many answers about knowledge acquisition in "passive." There were many answers about sharing, thinking, and behavior in students in "active." Specifically, examples included "Work of a child," "Content of a notebook," "Scene of activities," and so on. There were many answers regarding the difficulties of preparing materials beforehand in "experience." Questionnaire results about the question 2) "What do you think about the notes provided when the flash cards were created?" were classified as "subject," "how to copy," "content," and "other." Answers included comments on accessibility and also on concerns about the privacy rights of portraits including children. There were many answers about the manner in which the camera-works, as well as answers clarifying the purpose and object. Questionnaire results about question 3) "What do you think about the notes provided when editing?" were classified into "focus," "design," and "amount." There were many answers about adding marks to objects under "focus." In "design" answers mostly included comments on the simplicity and ease of viewable colors, as well as many answers about what many mark as unnecessary in "amount."

4. Conclusion and Discussion

Survey-1 is not sufficient to reveal the average time it takes to prepare flash cards because preparation time for teachers largely differs among individual. However, as previously mentioned, the average time for creating FCMs on Skitch was 14 seconds, with a maximum creation time on Skitch of 26 seconds. On the other hand, the average preparation time was 112.1 seconds, and the minimum time was 30 seconds. Therefore, it is considered that almost all teachers at elementary school can create FCMs on Skitch during class.

Survey-2 revealed more qualitative data about creating FCMs on Skitch. The results showed the following; A Skitch application tool can be adapted to feature "passive," "active," and "experiential" class content, covering reasons as to why some teachers may want to use FCMs on Skitch. Traditional FCMs are created in advance by teachers. Therefore, Traditional FCMs cannot be used in class for "active" and "experiential" learning, which has not been a previously predicted progression of the class. On this basis, it is suggested that FCMs by Skitch are more effective in class for providing a review of "active" and "experiential" type materials, which would be difficult to provide by means of traditional FCMs. In considering the classifications of features such as "subject," "how to copy," and "content" notes when creating FCMs on Skitch, these features were considered to be the same as traditional FCMs regarding "content." However, it is important to note the differences which were revealed concerning the "subject" and "how to copy" when taking pictures. In particular, if participants raised concerns about the publicity rights and privacy rights of the "subject." When considering features such as "focusing," "design," and "amount" in editing FCMs by Skitch, results revealed similar results for Traditional FCMs regarding the same topics. However, Traditional FCMs are easy to see in the original form because they are created from a blank, whereas FCMs on Skitch can be difficult so as to find a target for, because they are created from photos. In conclusion, it is important to be clear about the target and not to include too much additional information in each picture. Therefore, it is necessary that the expression should be easy-to-understand and one which keeps additional information to a minimum when creating FCMs on Skitch.

References

- KONNO, F. HIGUCHI, Y. MITSUISHI, T. (2009) A Study on a Teacher Reflection Method by Presenting Differences between Lesson Plan and Actual Instructions. *Japan Journal of Educational Technology*, 32(4), 383-393
- MURAKAMI, M. MARUYAMA, T. KAKUSHO, K. AZUMA, S. SHIMADA, S. MINOH, M. (2010) Development of Making Course Summarization using Lecture Video and Practice at University (Paper on Educational Practice Research. *Japan Journal of Educational Technology*, 34(3), 299-307
- TAKAHASHI, J. HORITA, T. (2011) *SUSUME of Flash-type Teaching Materials*, Obunsha, Tokyo

Research on Learning Support Using a Digital Pen

Yukiya ISHIDA^{a*} & Junichi IMAI^a

^a*Chitose Institute Science and Technology, Japan*

*y-kawani@photon.chitose.ac.jp

Abstract: This study proposes that digital pens may contribute to increased learner autonomy amongst university students who are struggling academically – specifically within the realm of mathematics. The researchers distributed digital pens to a low proficiency mathematics class to determine if the devices could meaningfully contribute to improved motivation to learn, academic performance, and autonomy.

Keywords: Learning Supports, Digital Pens, Learning Situation

1. Introduction

Due to declining birthrates, Japanese universities have loosened their admission policies, a change reflected in the national university entrance examinations, which have decreased in difficulty. Consequently, students with both high and low academic abilities are now attending many Japanese universities. However, the poor academic performance exhibited by many of these new students has been problematic. To remedy this, universities instated a GPA system and also developed college orientation programs, which include placement tests and remedial classes. Chitose Institute of Science and Technology offers such a program, established to prepare prospective university students a year prior to their studies. While Web Based Learning is a component of the program, its implementation could be refined to more adequately address each pupil's unique educational needs. To accomplish this, educators must first familiarize themselves with those needs, and provision appropriate guidance based on that knowledge. Therefore, this study proposes the use of digital pens in conjunction with web applications to gain a more refined understanding of learners' unique learning habits, both inside and outside of the classroom. The researchers tested this idea by distributing digital pens to a group of low-proficiency mathematics students enrolled in the aforementioned orientation program; the data collected were then analyzed to determine the device's effect on the participants' motivation to learn, academic performance, and development of autonomous learning.

2. Application

The authors were permitted to collect data captured during the participants' home studies of mathematics using the digital pens mentioned earlier. To document the students' progress throughout the study, the Deji Note Learning Management System was used. This data were extracted as the students transitioned from the first to second semester, and subsequently between two different topics. Using Deji Note, the researchers identified the beginning and end of each student's home studies on a weekly basis. Furthermore, these statistics were used to calculate the rate at which changes in the participants' motivation, academic performance, and autonomy occurred. The system also allows one to view recreations of a user's pen strokes (see Figure 1), and can be retrieved at any time. In the screenshot that follows, the plotted graph illustrates the learner's transition between activity and rest: the vertical axis denotes that the learner has begun writing, while the horizontal axis indicates rest. The plotted graph corresponds with the series of vertical lines to its left. Here, the black lines indicate activity while the absence of lines indicates rest. By analyzing these graphs, one can obtain a chronological overview of the user's motivation, performance, and autonomy in relation to time, and consequently, course content.

生徒名 (ID)	Learning time												思考時間		思考回数		記入スピード		得点	変遷	ノート				
	今週の子案 12/10/12 ~ 12/10/18												週計	平均	週計	平均	週計	平均				回数	回数	分平均	回数
	日付	10/12	10/13	10/14	10/15	10/16	10/17	10/18	金	土	日	月													
cist_2502 (cist2502)	予定													19.2分	2.7分	6.8分	1分	4回	0.6回	0画	0画	100/100	開く	開く	
cist_2503 (cist2503)	予定													124.5分	17.8分	29.4分	4.2分	12回	1.7回	3,297画	34.7画	100/100	開く	開く	
cist_2504 (cist2504)	予定													94.3分	13.5分	48.4分	6.9分	21回	3回	626画	13.6画	100/100	開く	開く	
cist_2505 (cist2505)	予定													119.6分	17.1分	58.1分	8.3分	19回	2.7回	0画	0画	100/100	開く	開く	
cist_2506 (cist2506)	予定													152.1分	21.7分	77.8分	11.1分	26回	3.7回	653画	8.8画	100/100	開く	開く	

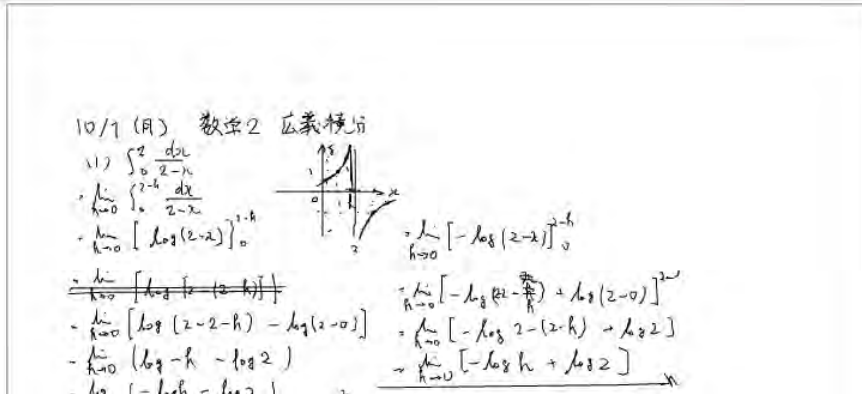

Figure 1. Deji Note Learning Management System

3. Case Study

In this case study, we carry out the learning using the digital pens to students. The study's participants comprised sixteen students attending orientation, all of which lacked mathematics proficiency. We lent a digital pen and notebook dedicated to them. We were used to them to self-study in the home. We were about a month the case study period. We were conducting learning situation of them by Deji Note System. Teachers had taught to students using the learning situation from the system once a week. By comparing participants' test results from before and after the pens were distributed, the authors could reliably gauge whether the devices exhibited a positive effect on students' motivation and academic performance. In addition to the quantitative data above, qualitative data were also collected in the form of interviews and questionnaires. Table 1 shows the learning status and test results. The average score of before test and after test of students who do not use the digital pen was 66 points and 70.7 points. Table 1 shows user's learning time (minutes), the number of pages of notes for the learning, test results before using the digital pen and test results after using it. The result of interviews and questionnaires, all the users have responded that learning time is increased compared to before using the digital pen. The percentage of students who responded motivation is improved by utilizing the digital pen was 85.7%. In the results of interviews, there was opinion that felt being monitored, a sense of crisis to learning. In addition, there was also the answer to the motivation of learning that was increased.

Table 1: A learning situation of students.

User	Learning time (minutes)	The number of pages of notes for the learning	Before test score	After test score
1	361	14	36	54
2	192	12	12	40
3	277	10	17	31
4	332	19	34	47
5	347	14	6	38
6	397	27	32	71
7	250	12	31	62
8	2943	197	32	82
9	354	17	33	69
10	69	2	32	27
11	563	38	34	52
12	146	8	14	41
13	832	24	33	66
14	352	21	27	73
15	271	22	13	38
16	275	12	31	42
Average	497.5	28.1	26.1	52.1

4. Consideration

Test scores of fifteen students out of sixteen were improved. Student of No.10 that test scores fell, learning time had the lowest. The difference between the students who use the pen and the students who do not use it is narrowed to 18 points from 40 points. From the above, the effect of learning by the digital pen available suggests. For contribution to the motivation, students of more than 80% answered motivation were improved. In addition, there was a similar opinion from the interview results. From the above, it has resulted in suggesting that their motivation is improved. While respondents admitted that their motivation had improved as the course progressed, this cause is not said to be due to only the digital pen. Because teachers had done learning support to students using the learning situation from the system once a week. Normally, in the university class, it is not performed tutoring such in most cases, we think to be necessary in the future to compare with the case of performing learning general teaching supports without using data from the digital pen. From the above, to students of low academic ability in particular, we can be considered that there is effective using the digital pen and learning supports using that data. To be specific, it is possible to give a sense of crisis training students and can grow attitudes autonomous. In the future, research of extending the learning period is required. In addition, there is a need for students of low academic ability layer other than, for example, conduct a demonstration evaluation to high academic achievement layer. It is considered that possible to improve motivation for learning is important. In the future, it will be necessary to consider the learning design more effective as well as aim to continue the fixing of study habits autonomous of the digital pen.

References

- Kawanishi, Y. E. (2007). A Case Study for an Evaluation of Web-based Educational Design in Total Education Programs of University. *Journal of Multimedia Aided Education Research*, 3(2), 105-114.
- Komatsugawa, H. (2008). ICT based educational to promote knowledge sharing of science and technology in higher education. *Journal of Multimedia Aided Education Research*, 5(1), 27-34.

Smart Phone based Data Collecting System for Analyzing Learning Behaviors

Chengjiu YIN^{a*}, Fumiya OKUBO^b, Atsushi SHIMADA^b, Kentaro KOJIMA^b, Masanori YAMADA^b, Hiroaki OGATA^b, Naomi FUJIMURA^a

^a*Innovation Center for Educational Resource (ICER), Library, Kyushu University, Japan*

^b*Faculty of Arts and Science, Kyushu University, Japan*

*yin.academic@gmail.com

Abstract: Nowadays, it is a hot topic to analyze the huge amount of data in the world. This issue also exists in the learning during students' life. The learning data are collected only to record students' learning status. As a result, most learning data are not used to improve the quality of learning for students. In this paper, we propose an order made education system, which can recommend students to select the courses they want to learn. In order to analyze students' learning behaviors, we collect students' learning data by using mobile devices.

Keywords: Data Mining, Analyzing Learning Behaviors, Big Data, Mobile learning

1. Introduction

Sensor networks have been widely used to detect certain aspects of the contexts of our daily lives, which embed computation and communication components into the environment (Peng et al., 2009).

By 2020, Ministry of Education, Culture, Sports, Science and Technology (MEXT) is scheduled to change all the textbooks for elementary, middle, and high schools into digital textbooks in Japan¹. Using the digital textbooks, all the learning history can be collected; meanwhile this will create a huge amount of data. Therefore, how to analyze the huge amount of data has been a hot topic, especially in the students' daily learning life. However, most of learning data collection is not aiming at giving students suitable reminders about students' learning status.

We carry out a BYOPC (Bring Your Own PC) program in Kyushu University, which encourage all students to use their own PCs in the University campus. We have set sensors in the university campus to collect and analyze the students' behavior and accumulate various educational data; moreover, this year we are planning to offer digital textbooks for the freshman of our university. All of these learning logs can be used for demonstrating students' learning behaviors. However, most of the system analysis does not focus on giving suggestion of students' learning status.

In this paper, by using mobile devices, sensor technologies, and digital textbooks, we propose a system to collect students' learning data and give students suitable reminders by analyzing students' learning behaviors. The system also provides recommendation and navigation for students to use their available space and free time effectively.

2. Related Work

2.1 Analysis of learning behaviors

¹ <http://www.mext.go.jp/>

Nowadays, many of studies are focusing to analyze student web-based learning behaviors. For example, Hwang et al. (2008) proposed to use Meta-Analyzer to assist the teachers to analyze student web-searching behaviors while they are using search engines for problem solving. Tsai et al. (2011) explored the correlates among teachers' epistemological beliefs concerning Internet environments, their web search strategies and search outcomes.

We can use our system to analyze students' learning behaviors and make students to remind their their learning status.

2.2 Open Educational Resources

Open educational resources (OERs), such as OCW, Moocs, have been widely documented recently. Learners can freely access these learning resources anytime and anywhere. Compared with OERs, traditional educational resources, such as books, textbooks, or their learning contents cannot easily be accessed in online. There are many difficulties in verifying the educational effectiveness with the traditional educational resources and supporting group learning.

Although there are various types of traditional learning resources, there is no research about measurement of the educational effects with those traditional learning resources.

3. System Overview

Students can use the various educational resources in many kinds of e-learning systems, and their learning history will be recorded by those systems.

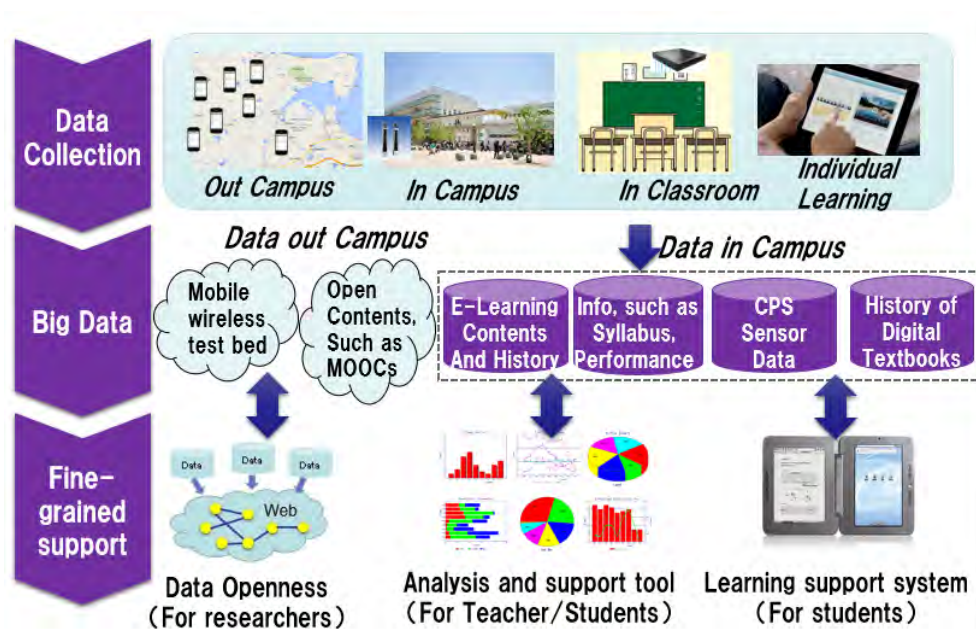

Fig 1. System overview.

As shown in the Fig. 1, many kinds of sensors are set in the campus of Kyushu University, in order to measure and visualize the learning effectiveness; our mobile system is used to collect and analyze various kinds of learning logs. Based on the analyzing results, the system provides recommendation and navigation for the users.

As for the experiment, we use not only the static data such as learning history and performance, but also the activity log such as the operation log of digital textbooks obtained from the camera or video sensors arranged on campus.

4. Scenario



Fig. 2 Underline



Fig3. Comment



Fig.4 Full text search

Mr. X is Japanese and he is studying Chinese in the classroom by using the digital textbooks. He can underline the important parts (Fig. 2), write his comment (Fig. 3), and carry out a full text search (Fig. 4). If he have some questions about Chinese language and need somebody to help him, he memorizes questions with the digital textbook. Then, the system searches a helper for him automatically; the system discovers some helpers who are good at Chinese finally. By using the data of the GPS sensor, the system recommends a closest helper Mr. Y who is in the 3rd floor of the same building for Mr. X. Then Mr. X can get help from Mr. Y.

5. Conclusion and Future Works

Mobile, wireless communication and ubiquitous computing technologies can provide learners and educators with active and adaptive support.

With the sensor technologies, learning systems can detect students' learning behaviors in the real world. Hence, educators and students can conduct more active and adaptive learning activities (Hwang, 2006).

In the paper, we proposed a mobile system with sensor network and digital textbooks. We can collect the educational data with this system in Kyushu University and give students suitable suggestions and supports by analyzing students' learning behaviors.

Acknowledgements

The research results have been achieved by “Research and Development on Fundamental and Utilization Technologies for Social Big Data”, the Commissioned Research of National Institute of Information and Communications Technology (NICT), Japan.

References

- Hwang, G. J. (2006). Criteria and Strategies of Ubiquitous Learning. Proceedings of the IEEE International Conference on Sensor Networks, Ubiquitous, and Trustworthy Computing, IEEE Computer Society: Washington, DC, USA, vol. 2, pp.72-77.
- Hwang G.J., Tsai P.S., Tsai C.C., & Tseng J.C.R. (2008), A novel approach for assisting teachers in analyzing student web-searching behaviors, computer & education, Computers & Education vol. 51, pp. 926–938.
- Peng, H., Chuang, P.-Y., Hwang, G.-J., Chu, H.-C., Wu, T.-T., & Huang, S.-X. (2009). Ubiquitous Performance-support System as Mindtool: A Case Study of Instructional Decision Making and Learning Assistant. Educational Technology & Society, vol. 12 , no. 1, pp.107–120.
- Tsai, P.-S., Tsai, C.-C., & Hwang, G.-J. (2011). The correlates of Taiwan teachers' epistemological beliefs concerning Internet environments, online search strategies, and search outcomes. Internet and Higher Education, vol. 14, pp.54-63.

Emergent Practices and Distributed Emotions in Educational Game Play

Beaumie KIM^{a*}, & Wing HO^b

^a*Werklund School of Education, University of Calgary, Canada*

^b*National Institute of Education, Nanyang Technological University, Singapore*

*beaumie.kim@ucalgary.ca

Abstract: This paper discusses the learners' encounters with an educational game called *DinoPlates*, which intends to support playful learning for secondary level Earth science concepts. *DinoPlates* simulates and lets learners control the Earth's processes and search for dinosaur fossils. We contend that the emergent interactions observed in playing *DinoPlates* may implicate a potential for liberalizing the social practices of the digital generation through an educational game play. Findings with Singapore secondary male students indicate that different pairs playing the game identified different practices for achieving their emergent goals. We discuss the opportunities that the design of *DinoPlates* affords for emergent interactions in game play, and the ways learners' emotional resources influence their practices.

Keywords: Educational game, distributed emotions, informal ideas, playful learning

1. Introduction

We have built Everest! We built Everest! We defeated Everest!

Leon and Justin, during game play

The types of learning that take place in teenagers' daily use of digital media (e.g., web 2.0, social networking, online games) are characterized by the interplay between unlimited resources and environments to create and experiment; and the growth of their ideas, passion, and agency (Thomas & Brown, 2011). The above excerpt is from a pair who played *DinoPlates* together. *DinoPlates*, an educational game for Earth science learning, simulates as well as lets players control the Earth's processes (i.e., tectonic plate movement and erosion) and search for dinosaur fossils from different geologic time periods. Leon and Justin had created towering mountain peaks in *DinoPlates*, and were announcing their achievement with reference to Mount Everest to their classmates. It gives us a glimpse of their excitement, and a potential growth in their passion for the learning.

The potential for learning with digital games has been of interest to researchers since the 1960's (e.g., Boocock & Schild, 1968), which has continued with different ideas and interests. Papert (1980), for example, created children's programming environment for creating games and building knowledge. More recently, Gee (2008) put forward learning principles seen from game plays and advocated digital games' potentials for education. On the other hand, there has been accompanying tensions between the need for playful learning (i.e., gaining knowledge and skills for better game-playing) and the need for educational values that are expected in school. This paper pays attention to the ways in which learners exhibit social practices of the digital generation, i.e., a new culture of learning (Thomas & Brown, 2011), when they encountered *DinoPlates*. In particular, we are interested in what sparks learners' emotional engagements in their game play that give rise to their ideas, passion, and agency. The work detailed in this paper draws on our implementation in an all-boys secondary school. The analysis was guided by following questions: 1) what kinds of learner interactions and practices emerge during game play?; and 2) how do the learners express their ideas and feelings about their practices? We derived our analysis from the video and audio recordings we collected during their in-class gameplay and interviews. We focus our observation on their interaction as a pair playing the game as well as how they respond and connect with other participants. The examples from our study illustrate the kind of learning that took place through their gameplay and conversations.

2. Emotions, Practices and Playful Engagement

Introducing new objects or new ways of using objects within a community requires its members to transform their ways of doing things, adopt new language, or play different roles outside their community boundaries. In many ways, the new objects may lead to transformation of the community itself (Tsurusaki, Calabrese Barton, Tan, Koch, & Contento, 2013). Digital games can create shared spaces that embody objects from disciplinary practices and transform the practices of school learning. Such possibilities are relevant to how game environments consist of models: they may model complex interactions in social, geographical and political settings as in *The Sims* or *Civilization*, simulate scientific principles found in many physics-based games, e.g., *Angry Birds*, and depict our cultural models about the world (e.g., how hero and heroine should look like, what are good and evil acts) (Gee, 2008; Squire & Patterson, 2011). *Civilization III*, for example, was developed with an in-depth understanding of history, geography and politics, and adopted for social science curriculum, which transformed the ways students interact and discuss about the civilization history (Squire, 2005).

When the modeling of a digital game is focused on the meanings of a disciplinary community, players may learn the community's skills, values and knowledge, and identify with the community. One of the Shaffer's (2006) epistemic games, *Urban Science*, models the contexts and problems of urban planner. This requires the players to behave like a professional planner and solve problems through research, consultation and mastery of a particular vocabulary. Such models and modeling embodied within games engage players in thinking and problem-solving of the disciplines. Focus on a real problem is an effective way to learn deeply about the subject and to own the scientific process (Klopfer, 2008; Scardamalia & Bereiter, 2006), which is a first step to think and act beyond the school boundary and to connect with informal ways of learning, i.e., social practices, with school learning.

We contend that the emergent interactions observed in playing *DinoPlates* – as opposed to planned/designed activities – may implicate a potential for liberalizing the social practices of the digital generation in formal school settings. Such interactions emerge and implicate learners' practices while socially situated in a particular learning and playing context. Playful learning is one of the important practices of the digital generation: it highlights learners' experimenting with their surroundings and embracing new things and changes, through which they invent and solve problems and advance their knowledge and skills (Jenkins, Clinton, Purushotma, Robinson, & Weigel, 2007; Thomas & Brown, 2011). Conceptualizing learners' interactions from the perspective of their emergent practices (cf. McCaslin, 2009) enables us to examine their actions and conversations in a meaningful manner. We use the word, "emergent" as being prominent at a particular situation.

Central to this interplay between play and learning are learners' emotions. Learners constantly appraise what is presented in the game and act accordingly (Eynde & Turner, 2006). Learners' ideas, emotions, and actions are sociocultural practices that often emerge in context. Learners' emotional engagement truly become their resources for playful learning: when learners find personal meanings of their activities, their emotions could direct their attention toward them (B. Kim & Kim, 2010; Pekrun, Goetz, Titz, & Perry, 2002). Learners' different ways of being and doing things are enacted in different settings and may shift depending on the situational demands (Gee, 2010; Roth et al., 2004), which are most likely accompanied by various emotions. In the following, we examine learners' expressions that indicate their emotions as resources for their emergent practices, and thus indicating their playful learning. Their emotion-bound personal meanings are implicitly played out by learners themselves in this particular gaming context and affect their practices with the game. We start by describing the design of *DinoPlates* and consider how it affords for emergent interactions in playing the game. Based on what we observed from the video recordings, we then discuss the emergent practices and the ways in which learners' emotional resources influence their practices.

3. Context of the Study

This study was part of a long-term collaboration between a university and an all-boys secondary school in Singapore. Some teachers and students of the school were involved in the design and implementation of the previous earth system science educational game prototypes. The game evolved in stages by involving learners and teachers as design partners in five progressive informant design workshops (Kim, Tan, & Kim, 2013), and *DinoPlates* is the latest game prototype.

3.1 The Game: *DinoPlates*

DinoPlates models convergent and divergent movements of a tectonic plate, layers of rocks, patterns of dinosaur fossil discovery (e.g., elevation, rock types), and natural forces that change landscapes (e.g., erosions by wind and rainfall). *DinoPlates* requires players to consider where and how fossils are exposed for their fossil search, which is similar to how paleontologists work. The development of *DinoPlates* incorporated learners' design ideas. In our informant design workshops, learners often designed quests involving plate tectonics: using tectonic forces as their power to achieve goals in the game (e.g., creating mountains, triggering volcanic eruptions) was the key component of their quest ideas (Kim et al., 2013). Our design incorporated learners' design ideas as well as our principle of situating concepts and knowledge within the disciplinary practices. Meaningful contents and activities support playful learning practices in educational games and help learners to engage their emotional resources for school learning and practices (Kim & Kim, 2010). Players directly affect the landscape to create mountains and erode lands and hills. Modeling plate tectonics is not an easy design task, not only for the complexity of the process but also for its vast scales of time and space. How to both model these processes and make them visible to players was an important issue in our design of *DinoPlates* (see Figure 1).

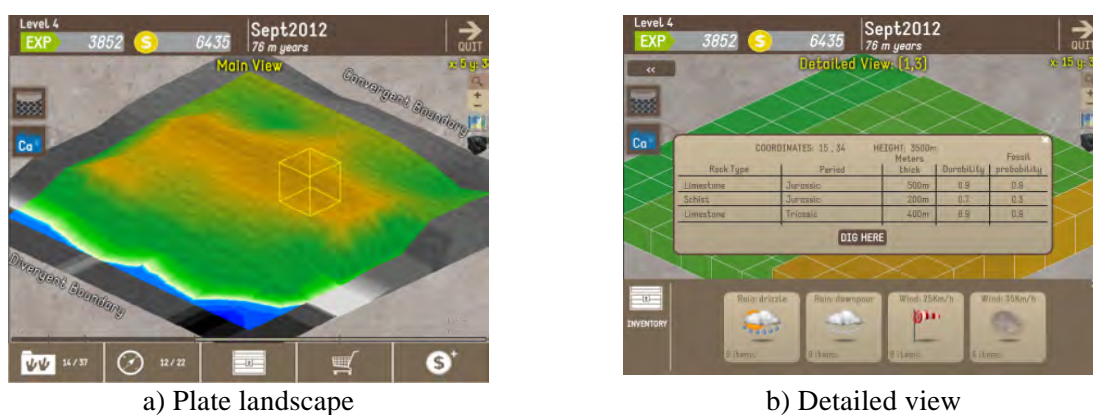

Figure 1. *DinoPlates* game interface

In *DinoPlates*, each player has a tectonic plate: one side is a convergent tectonic boundary (thus rising and forming mountains) and the other side along a divergent boundary (thus fracturing and decreasing in elevation over time) (see Figure 1a). The plate has a total of 10,000 squares. In Main View, the plate is a 10 x 10 map of grid squares, each of which in Detailed View expands to another 10 x 10 grid. Each square is many layers deep, comprised of different rock types and geological periods. Players have access to topographic and geological maps, and they can explore specific grid squares of the plate. When a player clicks on a square in a detailed view, the game displays information about the top three rock layers (rock type, geological age, thickness), and the player is given the option to dig for fossils there (see Figure 1b).

Players complete mini-quests and receive badges in *DinoPlates*. They range from simply reading the geological map; to finding a fossil at an elevation over 6,000 meters; to building a mountain over 10,000 meters high; to conquering a geological time period by discovering all the available fossils from it. Players can only dig the top layer of a square, so they must work to expose the desired rock layers. To do this, they can purchase and use various forces that modify the landform: winds and rains of various strengths, and convergent and divergent tectonic forces. They are deployed in units of many years to yield visible results in the game. Players earn coins and points as they excavate fossils, and the badges they earn enable them to complete the game.

3.2 The Study: Playing *DinoPlates*

The subjects of our study were a cohort of 12 to 13-year-old secondary one (grade 13) students in an all-boys school. Four classes played the *DinoPlates* prototype during supplementary geography lessons, and we gained informed consents from only some of the students from two classes to allow

us to study their game play. The sessions covered two periods (90 minutes) per class. Before allowing the students to enter the computer lab, the teacher asked them to find a partner to work with. They were paired to encourage discussion among themselves. In total, we collected data of 21 groups from two classes. The students collaborated in pairs with an exception of one group with three boys.

The teacher first had them sit away from the computers in order to brief them on the objectives of the session (i.e., experiencing and experimenting with various knowledge and skills from their geography lessons) and orient them with some open questions. He displayed the items from the *DinoPlates*' Store and discussed with them what could happen with such forces (e.g., heavy rain for 10,000 years). He then showed the introductory video that highlights the features of the game. Each pair was given a worksheet, on which they could record data on their fossil searches and changes in landforms. This activity with the worksheet was intended to create resources for their reflection and discussion after the game play. Their game play and group activity lasted about 40 minutes, including the time spent on starting up and creating their account. As we designed this prototype to be completed in about 60 minutes, students were encouraged to continue the game at home. The teacher gathered them again in the open area away from the computers and proceeded to debrief the students. The discussion was focused on what they observed, what they thought was happening, why they thought they were able to find certain fossils in certain areas, and what other questions they had around the fossils, rocks, and landforms.

The game design intended players to use the embodied knowledge within the game, which include rock types, plate movements and land formation, and properties of rock layers and fossils. We expected the players to engage in both gaming practices (i.e., examining and strategizing for quests) as well as disciplinary practices (i.e., examining location indicators in determining where to find fossils, evaluating layer and fossil properties, and using earth changing effects to facilitate their fossil search based on their understanding of fossils, layer properties and landforms).

3.3 Data Collection and Analysis

Video data was captured during the course of these sessions. The team set up the computer lab with individual webcams and screen capture software in advance. The recording captured students' expressions and discussions together with their in-game interactions. After initial analysis of the video recordings of the game play, we interviewed students by watching and having conversations around the video recordings of their game play (7 pairs and 1 group of 3 students). As an exploratory study no specific themes were pre-conceived in the initial phase of the analysis, but the following questions guided our analysis: 1) what kinds of learner interactions and practices emerge during game play?; and 2) how do the learners express their ideas and feelings about their practices?

The observation notes and video data were initially chunked into meaningful episodes and activities (i.e., logs) adopting the interaction analysis method (Barab, Hay, & Yamagata-Lynch, 2001; Erickson, 2006; Hay & Kim, 2007; Jordan & Henderson, 1995), to identify critical events, flow, and shifts in the process. Drawing on the logs, we started to look for themes and patterns, discussed them between the two researchers, and returned to the data for verification. We compared and contrasted the ways in which various components of the games were taken up by the learners in these events (Glaser, 1965; Strauss & Corbin, 2008). We examined how the learners were creating meanings and expressing their ideas, which indicate their existing or shifted ways of communicating, doing, and being in this particular context (Gee, 2010). Their interactions with the game and each other allowed us to identify categories useful in understanding how they relate to the game and also the practices they introduce to make the game more meaningful to them.

4. Emergent Practices and Distributed Emotions in Playing *DinoPlates*

Playing a game during school time provides a unique situation whereby the learners may constantly move in and out of the various practices (i.e., gaming practices, out-of-school social practices, and school practices). Out of the eight groups we observed as well as interviewed, we chose two groups (two pairs with pseudonyms) to discuss two of the themes to be presented in this paper. These two groups represent how learners mobilize informal ideas while searching for fossils and how they pursue situated and emergent goals during game play.

Danny and Zheng Yi are from an academically weaker class within their cohort. The school, however, is one of the higher ranked schools in the country. Zheng Yi came to the interview alone because Danny was not well on that day. Zheng Yi personally plays Team Fortress and Minecraft, and he pointed out that Danny plays Blackshot. He plays computer games for about 30 minutes to 2-3 hours a day depending on the time of the year (he plays less during exam time). He thinks Danny plays many other games everyday and is very good at them. It seemed that Danny knows he is better gamer than Zheng Yi: he called Zheng Yi a “noob”, when he made a mistake during game play.

Leon and Justin are from another class, which is considered a “high achievers” class in their level. They both mentioned Backyard Monster (a Facebook game) and Minecraft as games they play. They named their tectonic plate Korath, their favourite monster character from Backyard Monsters. They described Korath as a creature made of magma and covered by pieces of rocks, but they did not intend to associate it with the characteristics of the game.

Our analysis was focused on their actions and discourses that were emergent and not necessarily intended by our design of the game. The findings indicate that different groups identified different practices for achieving their emergent goals. We discuss how students approached their search for fossils, and how their goals and practices emerged during the game play. For each theme, we first discuss the general pattern emerged from various groups, and then provide an illustrative case from one of the groups described above.

4.1 Approaches to Fossil Search: Mobilizing Informal Ideas

We witnessed a range of modus operandi employed by the students to achieve the goal of finding fossils. They include relying on the information on fossil probabilities, looking for the appropriate rock types using the rock distribution map, finding target area to change the landform, digging as many places as possible (trial-and-error), or combinations of these. The most often seen strategy is reading the values of “fossil probability” presented in a table of information before they click on the “Dig Here” button. Figure 2 shows the information box, it appeared when a pair clicked a tile in an area (coordinates 12, 44). Each row shows a layer of the rock with their properties, and the line drawn across the window is the trace of mouse movement.

Rock Type	Period	Meters thick	Durability	Fossil probability
Limestone	Jurassic	500m	0.9	0.9
Schist	Jurassic	200m	0.7	0.3
Limestone	Triassic	400m	0.9	0.9

Figure 2. Pop-up Box for Digging a Tile

Fossil probability value of 0.9 in the top layer indicates a strong possibility of fossil finds from Jurassic period, which is also relevant to its rock type (i.e., limestone). Many students relied on the reading of the fossil probability to locate fossils as a way of deducing the fossil presence. Other information in Figure 2 includes the thickness and durability of the layer, which are useful if they are interested in eroding the layer to reach the next layer. Some students indeed added another step by using some earth-changing effects (wind and rain) that was followed by an excavation of fossils in the deeper rock layer.

For Danny and Zheng Yi, examining the fossil probabilities was one of the possible means for their fossil search. Earlier in the game play, they went into the shop after earning some coins with a mini-game instead of spending the coins to dig for fossils. Zheng Yi controlled the mouse most of the time, and Danny told him to buy Rain Monsoon (strongest and most expensive among different types of rain effects). They discussed about Divergent force, but Zheng Yi bought Convergent force. Looking at the items they had, Danny initiated the idea of using the convergent effect to create mountains and then apply the rain monsoon effect to cause a landslide to expose fossils.

- Zheng Yi : ((enters the inventory menu to check on the earth changing effects they purchased: Rain monsoon and convergent tectonic effects are in their inventory))
- Danny : ((laughs)) You, you, you convergent right, then you (form) one mountain, then you (dig) bones.
- Zheng Yi : (use) rain monsoon.
- Danny : No, ((laughs)) you, you put convergent, make it damn high first, then you go put rain monsoon, landslide all the way.
- Zheng Yi : Explore this ((chooses an area in the main view to explore))
- Danny : You should put it here ((points at an area on the monitor screen/main view)), then you like monsoon all (the things).
- Zheng Yi : (This one) monsoon (here)
- Danny : No. You convergent first, then everything *damn high* ((hands gesturing a mountain peak)) ((laughs)), then you rain monsoon, then *whole thing* fall.

Danny and Zheng Yi were not articulating fluently when they were describing their strategies to expose fossils. We, however, can see that Danny constructed his logic by adding elements to his explanation as he tried to convey his idea to Zheng Yi several times. Danny initially only had the idea of forming a mountain to find fossils, and then he added rain monsoon effect when Zheng Yi mentioned it. In the end, in order to better express and simulate what he was imagining, he used his hands to gesticulate the peaking and eroding mountain. Although he did not express much at that time, Zheng Yi seemed to be mobilizing his informal ideas and knowledge on how the earth changes. He explained their approach as following during the interview:

We used convergent and rain effects because the effects are *more drastic*, like more changes... Because we tried, and it ((rain)) seems to clear more lands so we want to use rain (to clear quickly), and convergent to show us more ((fossils)). In class also learn that. Water will *erode faster* than (wind)... It's to show the bottom of the surface ((the lower layer of the plate)), because the bottom (pushed up on top then washed) down, I think... (First) convergent, then wash down so that, even *more exposed*.

Danny and Zheng Yi's approach seems to demonstrate how some students were able to use and experiment with their own informal ideas and prior knowledge on how fossils are exposed and how the land goes through changes. Such informal ideas are the most important resources for their learning (Kim et al., 2012; Kim et al., 2013), and we see the potential of their everyday learning practices being brought forward while playing the game. At the same time, learners expressed the prospective simulation of the game and its earth changing effects (i.e., representations) with words that emphasize on what they imagine as exciting changes (i.e., drastic changes, emphasis added in the excerpts above). Danny's persistence in expressing the earth's processes reveals how closely he is connected to his own ideas. It illuminates how Danny anchored his emotional relationship with the content (i.e., being able to experiment with his own ideas) and with representations to be processed based on their choices (i.e., mountain formation and erosion).

4.2 *Situated and Emergent Goals*

Playing an educational game with their peers in the school computer lab certainly provides a very different atmosphere from a teacher delivering a traditional lecture in their classroom. It is different from their out-of-school gaming situations. Learners in this situation are constantly navigating among the various contextual cues as gamers, playmates, and students, and we observed that their personal goals emerge in the course. Such emergence especially came with students' experimenting with their ideas, not only to find more fossils (as in Zheng Yi and Danny's case) but also just to see what happens with the simulated environment in *DinoPlates*. A pair, for example, tried to excavate the sea area to test the possibility of fossils in the waters: the game offered a safe space for the players to experiment. In another group we observed, one of the boys was trying to influence his partner, who is on task with fossil searching, to join him to create mountains after seeing the "Build a 10000 meters Mountain" icon on the Quest bar. As they go along, their game trajectory included the purchase of more convergent effects to create mountains. Such emergent goals are triggered by different events

for each group, as they were playing the game and interacting with their peers, the teacher, and researchers.

For Leon and Justin, their goal of creating a mountain emerged when the teacher commented on what they did in the game. When the teacher was walking by their computer, he observed that their landscape was dominated by a massive mountain:

Teacher : What monstrosity have you created? ((referring to the massive block of mountains formed in their landmass, see Figure 3)).

Justin : ((controlling the mouse)) Huh?

Teacher : It's huge.

Justin : I know. (Found) it.

Leon : ((giggling)) Monstrosity... ((continue giggling as the teacher walks away)).

Justin : Maybe you know (where it is). ((In the main view, they maneuver the frame and position the group of mountains to the fore)).

Leon : Eh, do some more.

Justin : ((selecting and exploring an area by the mountains)) I am going to try blowing up, you know, the tall area? Yah? I am going to try blowing it up.

Leon : How?

Justin : OK, let's... ((entering the Inventory menu, choosing the Convergent tectonic effect, and dragging the effect to the mountains)).

Leon : Yah, dump it there, dump it there.

Encouraged by their teacher's comments, Justin and Leon set off to create more ambitious ones. They employed convergent tectonic effect generously on the mountain to cause it to elevate further. This self-driven task was performed with much pleasure as both Leon and Justin "conspired" to create something of monumental scale. They spent the next few minutes applying more convergent forces on the plate, which triggered more effects on the land mass (i.e., stronger convergent forces on the grid squares they chose subsequently causing other parts of the plate to converge and raise higher).



Figure 3. Justin and Leon's Korath Plate

In the next excerpt, Leon had dragged convergent tectonic effects onto the mountains. They are waiting for the results of the effects indicated by exclamation marks. At times, the game will generate effects and exclamation marks automatically without the need for players to plant any effects on the grid squares. These exclamation marks when activated, display information on the type of natural phenomenon that has occurred. Blue exclamation marks would show up and blink to alert the players to click on it when certain events had happened (e.g., erosion of the landmass or convergence of the plate by the player's application of effects or by the system's simulation). When they clicked on a blinking exclamation mark, it announces that rain monsoon had taken place:

Justin : Oh, no, no, no, that one is a natural one. Wait for one of those (we put). ((waiting for the Convergent tectonic effect timer to complete the count-down)). ((A blue exclamation mark appears randomly to convey a natural event taking place.))

Justin : Eh, another one. ((the blue exclamation mark)).

- Leon : See, one. ((clicks on the mark, and it disappears)) Eh, what's wrong?
- Justin : Just wait, just wait. ((A box pops up congratulating them for accomplishing a task of building a 10,000 meters high mountain in five minutes and earning 1000 coins))
- Justin : We have built a mountain.
- Researcher: Oh, built a mountain. You have finished. ((Leon giggles)).
- Justin : Whoaaa... ((Leon starts to giggle louder when they change the view revealing a taller mountain)) *All those convergence really work.* ((Leon laughing)). *All those convergence really work.* ((two other convergent effects they planted turned to blue exclamation marks consecutively and Justin clicks on them)).

They were ecstatic when they built a 10,000 meters tall mountain, and continued to put more convergent tectonic forces. As they saw more mountains were peaking up, they invited other friends to witness what they had created and announced that they built and defeated Everest. When we asked them about it during the interview, they said,

- Leon : It's actually a mountain because of the convergent plate. Then they were folding and creating a large mountain. And later on, we actually decided to, like, make it bigger... 'Cause, Mt. Everest's supposed to be the tallest mountain so we wanted to make it even taller than that... The time was almost over so we tried to have a bit more fun with the (world) and so we actually just built this gigantic mountain and then after that... with reference to Everest.
- Justin : ((They used more convergent effects because)) just curious to see what would happen. See how, how it can be... We spam on it ((convergent boundary))...'Cause we did what we wanted to do, (so we were) having a bit of fun ((with regards to announcing Everest)).

Leon and Justin introduced their personal goal into their game play when they decided to apply multiple effects in a single area. This kind of motivation to explore and create can become a powerful resource for playful learning during the game play. When they are engaged to complete personal goals, they are empowered by their decisions, and their accomplishments become personally meaningful. Such endeavours we saw from Leon and Justin are highly situated and emergent in this particular context: there was a limited play time within the school's curriculum schedule, there were adults who acknowledged their accomplishments, and there were other classmates whom they could share their achievements immediately. In contrast to Zheng Yi and Danny's account, Leon and Justin's emotional relationship (i.e., excitement expressed through their giggling and laughing and their words of awe) is associated with how the game created the representations beyond their expectations, how their teacher and their classmates respond to the changes, and how the concepts (i.e., convergent boundaries and how high mountains in the world formed) existed in textbooks came into play.

5. Discussions: Evaluating Objects, Environment, and Accomplishments

What we have discussed above is the glimpse of the possible interplay between their play and learning. There were variations in students' approaches to fossil search, but mobilizing their ideas and experiences as students and game players was a common practice among different groups. Their goals and practices emerged within the context of game play and also indicate an interplay between formal and informal practices: students were focused on their practice of playing and experimenting with the game, but at the same time were amused and excited by the events occurred in the game and the social activities they engaged in with their friends.

During the game play, many of the pairs working together compared and announced their achievements with their classmates around them. Their actions informed us that they were sharing information on what they were doing and at the same time inviting their peers to join similar practices. They looked for indicators of their status as game players and introduced competitions among them. Leon and Justin, as discussed above, were very excited to announce their accomplishments, when they said, "We *defeated* Everest." Such status enhancement and competition were within their game play (i.e., defeating Everest) as well as with their friends around them. They are able and empowered

to create, discover, and evaluate various indicators (e.g., the highest mountain in the world, the properties of dinosaurs they find) by creating their personal and social goals situated within this context. Similar youths' coveting for status and ranking through new media production, games, and social media was described by Ito and colleagues (2010), whereas student initiated these elements into the formal space in our context.

Playful learning is one of the important practices of the digital generation: it highlights learners' experimenting through their actions with their surroundings and embracing and familiarizing new things and changes, through which they invent and solve problems and advance their knowledge and skills. Two pairs in our illustrated examples above have shown their capacity to experiment and invent. Central to this interplay between play and learning, lie students' emotions. As discussed above, Leon and Justin were experimenting with the game environment to explore how the convergent effects work as well as to have "fun", and giggling and laughing were common in their group play. While developing his strategies to expose fossils in the game, Danny connected the mountain formation and erosion processes with his approach and described it to his partner, Zhengyi with much laughter and conviction. Such emotional engagement truly become their resources for playful learning (Kim & Kim, 2010), and it shows the learning potentials and design implications for an educational game that can invite their practices of play. For Leon and Justin, their interview revealed that their game play continued at home and triggered them to search and read more information about the dinosaur fossils they found.

Playful learning also involves evaluating their artifacts and actions, and expressing their judgments through their words and actions. When Justin told Leon, "Wait for one of those (we put)" for their convergent effects, they value their actions they performed earlier on the game rather than effects automatically created by the game. In the exchanges not reported in this paper, Danny and his friends compared fossils they found and they wanted to know if other groups have found fossils of a whole dinosaur rather than parts (e.g., tooth, claw, jaw). Learners also evaluate their own actions and express their judgments when they play. For examples, Leon and Justin called their action of putting many convergent effects as "spamming", expressing the value they see for such actions. For Justin and Leon, the words used in action (e.g., fighting and shooting) games seem to express their excitement and emotional attachment to their current game interactions. When they decided to build high mountains, Justin told Leon that he would try "blowing it up." Leon, on the other hand, excitedly announced to his friends that they have "defeated" Everest, as they know that it is the highest mountain in the world. By using such informal terms of play to describe their actions, learners situate themselves in a playful mode within a formal school setting.

6. Conclusions

We recognize and emphasize that what we observed above are highly situated in this context: (1) the game play was with a classroom full of boys, many of whom are experienced with playing games; (2) there were tasks given by the teacher and being created by themselves; and (3) their classmates as well as the presence of the teacher and the researchers constantly influenced their interactions. For example, instead of chastising and regulating their overzealous excitement in the formal space, the teacher played the role of a "co-conspirator" (Ito, 2010), rousing Leon and Justin's interests with his comments encouraging them to make advancements in the game. This spontaneity seen in students may say something about classroom teaching and the potential of setting up a nurturing learning space. In our case of educational game play, learners' emergent interactions as students, playmates, and gamers can all be productive in their learning efforts, in which they use their informal ideas, negotiate for their ideas and roles within the group, create personal goals and competitions, find ways to have fun, create and solve problems together, and seek recognitions and confirmations from the teacher and peers. Learners' playfulness and excitements were expressed through their actions and terms they used. We believe that the skills required in the new media culture (as discussed in Jenkins et al., 2007) are used in our learners' everyday social practices and that we need to provide learners with the opportunities to recognize their own legitimate ways of learning and use them well in the school contexts. We hope that our on-going efforts provide design implications for engaging learners in playful learning potentially liberalizing their social practices of the digital generation.

References

- Barab, S. A., Hay, K. E., & Yamagata-Lynch, L. C. (2001). Constructing Networks of Action-Relevant Episodes: An in Situ Research Methodology. *The Journal of the Learning Sciences*, *10*(1/2), 63–112. doi:10.2307/1466830
- Boocock, S. S., & Schild, E. O. (1968). *Simulation games in learning*. Beverly Hills, CA: Sage.
- Castanheira, M. L., Crawford, T., Dixon, C. N., & Green, J. L. (2000). Interactional Ethnography: An Approach to Studying the Social Construction of Literate Practices. *Linguistics and Education*, *11*(4), 353–400. doi:10.1016/S0898-5898(00)00032-2
- Erickson, F. (2006). Definition and analysis of data from videotape: Some research procedures and their rationales. In J. L. Green, G. Camilli, & P. B. Elmore (Eds.), *Handbook of Complementary Methods in Education Research* (pp. 177–191). Mahwah, NJ: Lawrence Erlbaum Associates.
- Eynde, P. O. 't, & Turner, J. E. (2006). Focusing on the complexity of emotion issues in academic learning: A dynamical component systems approach. *Educational Psychology Review*, *18*(4), 361–376.
- Gee, J. P. (2008). *What video games have to teach us about learning and literacy* (Revised and updated.). New York: Palgrave MacMillan.
- Gee, J. P. (2010). *An introduction to discourse analysis: Theory and method* (3rd ed.). Florence, KY: Routledge.
- Glaser, B. G. (1965). The Constant Comparative Method of Qualitative Analysis. *Social Problems*, *12*(4), 436–445. doi:10.2307/798843
- Hay, K. E., & Kim, B. (2007). Integrated temporal multimedia data (ITMD) research system. In R. Goldman, R. Pea, B. Barron, & S. Derry (Eds.), *Video research in the learning sciences* (pp. 521–536). Mahwah, NJ: Lawrence Erlbaum.
- Ito, M. (2010). *Hanging out, messing around, and geeking out: kids living and learning with new media*. Cambridge, Mass.: MIT Press.
- Jenkins, H., Clinton, K., Purushotma, R., Robinson, A. J., & Weigel, M. (2007). *Confronting the challenges of participatory culture: Media education for the 21st Century*. Chicago, IL: MacArthur Foundation. Retrieved from <http://www.macfound.org/press/publications/white-paper-confronting-the-challenges-of-participatory-culture-media-education-for-the-21st-century-by-henry-jenkins/>
- Jordan, B., & Henderson, A. (1995). Interaction analysis: Foundations and practice. *The Journal of the Learning Sciences*, *4*(1), 39–103.
- Kim, B., & Kim, M. S. (2010). Distributed emotions in the design of learning technologies. *Educational Technology*, *50*(5), 14–19.
- Kim, B., Tan, L., & Kim, M. S. (2013). The affordances of informant design in educational game development. *International Journal of Arts and Technology*, *6*(3), 215–228. doi:10.1504/IJART.2013.055388
- Klopfer, E. (2008). *Augmented learning: Research and design of mobile educational games*. Cambridge, MA: MIT Press.
- Papert, S. (1980). *Mindstorms: children, computers and powerful ideas*. New York: Basic Books.
- Pekrun, R., Goetz, T., Titz, W., & Perry, R. P. (2002). Academic Emotions in Students' Self-Regulated Learning and Achievement: A Program of Qualitative and Quantitative Research. *Educational Psychologist*, *37*(2), 91–105.
- Roth, W.-M., Tobin, K., Elmesky, R., Carambo, C., McKnight, Y.-M., & Beers, J. (2004). Re/Making Identities in the Praxis of Urban Schooling: A Cultural Historical Perspective. *Mind, Culture, and Activity*, *11*(1), 48–69. doi:10.1207/s15327884mca1101_4
- Scardamalia, M., & Bereiter, C. (2006). Knowledge building: Theory, pedagogy, and technology. In R. K. Sawyer (Ed.), *The Cambridge Handbook of the Learning Sciences* (pp. 97–115). New York: Cambridge University Press.
- Shaffer, D. W. (2006). Epistemic frames for epistemic games. *Computers & Education*, *46*(3), 223–234. doi:10.1016/j.compedu.2005.11.003
- Squire, K. D. (2005). Changing the game: What happens when video games enter the classroom? *Innovate: Journal of Online Education*, *1*(6). Retrieved from <http://www.innovateonline.info>
- Strauss, A., & Corbin, J. M. (2008). *Basics of Qualitative Research: Techniques and Procedures for Developing Grounded Theory* (3rd ed.). SAGE Publications.
- Thomas, D., & Brown, J. S. (2011). *A new culture of learning: Cultivating the imagination for a world of constant change*. Lexington, KY: CreateSpace.
- Tsurusaki, B. K., Calabrese Barton, A., Tan, E., Koch, P., & Contento, I. (2013). Using transformative boundary objects to create critical engagement in science: A case study. *Science Education*, *97*(1), 1–31. doi:10.1002/scs.21037

Investigating Factors Affecting Conceptual Learning Progression when Playing Digital Game-based Inquiry Learning for Energy Education

Patcharin PANJABUREE^{a*}, Ugyen DORJI^{a,b} & Niwat SRISAWASDI^c

^a*Institute for Innovative Learning, Mahidol University, Thailand*

^b*Gelephu Higher Secondary School, Bhutan*

^c*Faculty of Education, Khon Kaen University, Thailand*

*panjaburee_p@hotmail.com

Abstract: One of the challenges of promoting students constructing knowledge on abstract topic as energy is helping them make the relationship between the theoretical-world and their life outside the classroom, through inquiry of the elements of energy consumption by daily used household electrical appliances in the digital game. Factors that increase students' conceptual learning progression in the digital game-based inquiry learning are challenged to be investigated. In this study, factors of Enjoyment, Inquiry, and Intention to Use were selected as important attitudes in learning game and promoting conceptual learning progression. To verify the effectiveness of the game, sixty-six secondary school students participated in the digital game-based inquiry learning for energy education. The results showed that the game impacted moderately on improving the students' conceptual understanding progression on energy consumption topic, students' inquiry of the game has a significant relation with their learning progression, and students' enjoyment and intention to use with the game do not significantly have a relation with their learning progression. Our results suggest that there are attitudinal factors affecting conceptual learning progression gained by the digital game-based inquiry learning.

Keywords: Game in education, learning progression, energy education

1. Introduction

It is known that school science subjects, like physics, chemistry and biology contain lots of theoretical concepts which students find difficult to understand and thus have misconceptions in it. Because of this, students rarely link the knowledge gained from those sciences in day-to-day life. This is all due to the narrow relation between how they are taught and what they learn (Kurt and Ayas, 2012; Ozmen, 2008). Normally in traditional teaching approach, teachers often over-rate the importance of their content and under-rate their impact in students' learning. Thus, attempts to teach students all that they need to know become ineffective because students forget much of the content that they memorize. Most of the time in traditional teaching, teachers concern much about time limitation for teaching vast content of the subjects so they rarely encourage students in class discussion, collaborative learning, and inquiry-based activities that often take time. However, for effective learning, teachers must develop learning activities that encourage students on how to use scientific knowledge to solve important queries and help in deep thinking rather than worrying about covering the content. Deep thinking is essential because understanding is the residue of thinking. To encourage thinking, learning should incorporate activities that create a joy, an excitement, and loves for learning so that the students will be impatient to run home, study, and contemplate— to real learning (DiCarlo, 2009).

In the recent years, there are varieties of resources developed and are available. Incorporating such resources can be the best appropriate instructions that can fit the goal of achieving active learning. This has been a challenge for science teachers especially to teach abstract concepts, such as energy to young children (Duit, 1981; Yuenyong, Jones and Sung-Ong, 2011). So there has been always hunt for better learning method(s) to inculcate this concept in students because energy education has become an

area of major importance for those who are responsible for school teaching. As per DeWaters and Powers (2011), energy education enables clients to identify the better ways to save energy. However, the study indicated that while almost everybody agrees that they want to conserve energy, this often does not translate into action. Further, the study also showed that domestic energy usages are invisible to the consumers most of the time. This is simply because most people have only a vague idea of how much energy they are using for different purposes and what sort of difference they could make by changing day-to-day behavior or investing in efficient methods. For this reason, energy consumption has not declined significantly in reality (Boyde, 2002; Yang, Chien and Liu, 2012). This difficulty may be due to the fact that users usually either do not know how much electricity is consumed by their household electrical appliances or do not have any idea of how to save electricity in an appropriate way. As stated by Bates (2003), to meet the consequences of the paradigm shift from industrial age to information age, the current approaches and methods of instructions are insufficient. Eventually, the instructional designers are facing with the challenges of making learning situation to fit an instructional design/ development of model rather than selecting suitable model to fit the needs of changing learning situations (Gustafson and Branch, 2002).

In recent years, there are many books and articles published, indicating various approaches for learning the different forms of energy, energy transformation, and the law of conservation of energy (Aggul, Yalcin, Acikyildiz and Sonmez, 2008). However, student's prevailing ideas about energy are still found to be different from the scientific perspective. These days, a number of active learning units employing simulations and games have been developed for educational purpose in many disciplines like mathematics, science, engineering, humanities, and social sciences (Cai, Lu, Zheng and Li, 2006; Eck, 2006). Many students prefer learning by using computer games as it has lots of benefits in students' habits and interests (Gee, 2006; Prensky, 2007). Games in education provide students to interact and gain learning experience from those activities that are closely relate to realistic situations that help students to apply their knowledge, skills and strategies to make decisions in their assigned task. Consequently, the students' intellectual capacities and expectations about learning are enhanced. Papastergiou (2009) viewed that games and simulations integrated with contents help in teaching concepts through the transformation of experiences. Thus, the computer games can be used as learning tool to teach the factual information as well as worksheet activities for teaching and learning process (Spraggins and Rowsey, 1986).

Therefore, this study develops a digital game incorporating with inquiry-based learning strategy called Digital Game-based Inquiry of Energy Education to assist students' learning in learning energy consumption. When playing the developed game, the students were encouraged to use electrical appliances for certain durations and to adjust the appropriate duration with each electrical appliance in a meaningful way of learning conceptual understanding of factors of energy consumption. In this study, we examined how much students' conceptual learning progression size after participating in the developed game. Moreover, the factors that increase students' conceptual learning progression in the game are challenged to be investigated to know the attitudinal factors affecting their conceptual learning progression.

2. Background and Motivation

According to National Research Council (2000), the authors summarized their research findings that students have different preconceptions about how the world works. If the teachers do not engage and link students' initial understanding into new concepts then, they may fail to grasp the new concepts and information that were taught, or they may land up learning for the purpose of test only. Such that, to develop competence in an area of inquiry, students must have a proper foundation of factual knowledge, comprehend facts and ideas in the context of a conceptual framework, and organize knowledge that facilitates retrieval and application. Therefore, it is vital to choose appropriate strategy to develop learning tools (Charsky and Ressler, 2011; Chuang and Chen, 2009; Wang and Chen, 2010).

Inquiry-based learning is a strategy to enhance learning by engaging students in authentic investigations, achieving a more realistic conception of scientific endeavor as well as providing a more student-centered and motivating learning environment (Kubicek, 2005). Teachers act as a facilitator who provides the opportunity for students to observing, examining books and other sources of information using tools to gather, analyze, and interpret data which students learn from their

explanation, predictions, and communicating the results. (Krajcik and Blumenfeld, 2006; Kuhn, Black, Keselman and Kaplan, 2000). Regarding to provide opportunity for students to observe, gather, analyse, construct their own conceptual knowledge; in this study, the inquiry-based learning strategy was chosen to design a digital game-based learning to assist students explore the factors of energy consumption by using electrical appliances for certain durations and adjusting the appropriate duration with each electrical appliance. These features of the game might help students to improve their conceptual knowledge on energy consumption. As such, we hypothesize that:

H1: Students' conceptual learning progression through Digital Game-based Inquiry Learning has medium gain size or high gain size when using concept of Hake (1998) normalized gain $\langle g \rangle$.

When the digital game-based inquiry learning can help students to improve conceptual learning progression in medium gain size or high gain size; then, in our case, we can imply that it is successful digital game-based inquiry learning. Such that the students' attitudes toward the digital game-based inquiry learning are challenged to be investigated to know the factor(s) affecting their conceptual learning progression. In this study, the factors of Enjoyment, Inquiry, and Intention to Use were selected as important attitudes in learning game and promoting conceptual Learning Progression.

Enjoyment is the degree to which activity is perceived to be personally enjoyable (Davis, Bagozzi and Warshaw, 1992). When the students participate in a game, they are reduced anxiety and feel confident to construct knowledge. This is the sense of enjoyment in the game (Vorderer, Klimmt and Ritterfeld, 2004). We can imply that higher levels of enjoyment affect higher conceptual learning progression size. Moreover, as mentioned above, the inquiry-based strategy is the method to which learning sequence is perceived to be personal inquiry. The term of inquiry while the students learn through a game facilitate exploration and help students construct conceptual knowledge on specific concept. We can assume that higher levels of inquiry affect higher conceptual learning progression size. In addition, the intention of use is considered as common factor on most of the game acceptance studies (Ha, Yoon and Choi, 2007; Hsu & Lu, 2004; Venkatesh and Bala, 2008). The students' attitude toward playing or intention to use the game will facilitate the practical use of a digital game system. We can imply that higher levels of intention to use affect higher conceptual learning progression size. Hence, we have hypotheses as follow:

H2: Students' Enjoyment with the digital game-based inquiry learning has a positive relation with their Learning Progression size;

H3: Students' Inquiry with the digital game-based inquiry learning has a positive relation with their Learning Progression size;





H4: Students' Intention to Use with the digital game-based inquiry learning has a positive relation with their Learning Progression size;

3. The Digital Game-based Inquiry Learning

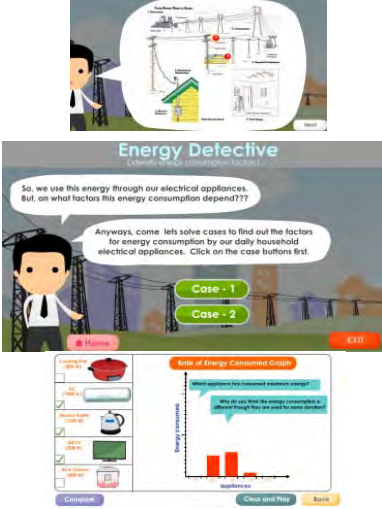
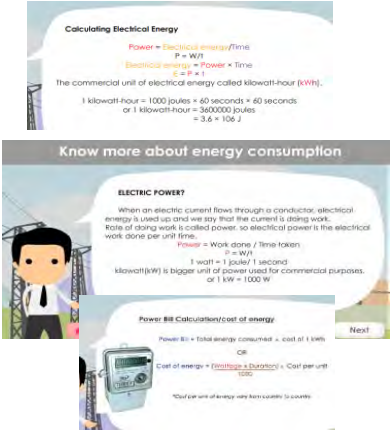
For the purpose of our study, we developed the digital game-based inquiry learning. The main purpose of the developed game is to improve the conceptual knowledge of energy consumption. The developed game provides ways by which students can experience their subject in different manners. The game brings the world (reality) into the classroom and appeals to actively engaging students. While learning through the game, the students are provided opportunity to think more critically about their own progress and abilities. The developed game media follows the design rationale for the proposed game-based learning units that guide the students in transforming their knowledge on electrical energy consumption into their daily life applications. Furthermore, the learning game is embedded within inquiry-based learning approach. It helps students engaged in a new concept by relating their previous knowledge by exploring and explaining through their experiences, then elaborating on what they have learned, and finally evaluating their understanding on that new concept under the guidance of teachers. Eventually, this enhances students' conceptual understanding of subject. Table 1 shows the summary of the developed game.

Table 1: The learning activities in the digital game-based inquiry learning for energy education

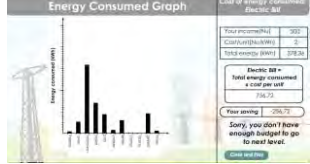
Steps	Pictorial representation	Learning activities
1. Engagement		<p>The lesson begins with scenario that commonly happens at our home. Example, father gets a monthly power bill claiming Nu. 6,500/- (Currency used in Bhutan). But his monthly salary is just Nu. 10,000/- now he has pay more than 50% of his income just on power bill.</p> <p>This arise curiosity and engage students to investigate the cause of power consumption. Teacher further encourages them with some common questions, like</p> <ul style="list-style-type: none"> - list down electrical appliances operated at our home? - any idea how much energy is been consumed by those appliances? <p>Eventually, teacher will link to learning unit.</p>
2. Exploration		<p>To investigate reason for high power bill; students explore the cases in “Energy Detective”- interactive simulated learning module to identify the factors for energy consumption. It also explains, elaborates and evaluate students understanding on transmission of electricity to our home, how power bill is calculated, unit of electrical energy is derived, etc. In the meanwhile, teacher keeps note of the findings and reinforce participants to find reasons to support their findings.</p>
3. Explanation		<p>After exploring through the interactive units to identify the factors for energy consumption, students solve problems provided in the worksheets and present their findings to the class. Teacher then displays and compares their findings, and ask them to summarize the findings in identifying the factors for energy consumption in electrical appliances. Subsequently, teacher introduces important formulas, relations and units related to energy consumption context.</p>

Steps	Pictorial representation	Learning activities
4. Elaboration	  	<p>Theoretical knowledge of energy consumption is then extended into the interactive game “Energy Efficiency Game: know your power bill”. This provides students opportunity to apply the abstract concept of energy consumption to into practical, which help them to visual and understand clearly in a playful way. Students find ideas about rate of energy consumption and how to conserve it. Thus, the knowledge on energy consumption is elaborated into energy conservation. In the meantime, teacher ask the students the ways of saving more money while playing the game and encourage them to share the ideas with rest of the friends.</p>
5. Evaluation	 	<p>“Shopping: know your home electric appliance better” is an interactive game, students can interact and choose commonly used home electrical appliances from the list. This module evaluates students’ self-awareness in using electrical efficient appliances to conserve energy. Further, teachers elaborate the context into daily life situations and provide additional information on it and provide opportunity to students to share their knowledge on energy saving at their home and school. Finally, the teachers summarize/ debrief on the learning unit.</p>

4. Research Methodology

We will investigate the four research hypotheses of this study. In the first research hypothesis (H1), a Digital Game-based Inquiry Learning has improve students’ conceptual learning progression in medium gain size or high gain size; results on H1 will lead us to the other three hypotheses (H2, H3, H4) in order to clarify which factors affect the students’ conceptual learning progression.

4.1 Experiment Procedure and Participants

The research design was one group pre-posttest design. A total of 66 tenth graders of secondary school students (37 females and 29 males) in eastern Bhutan participated in this study. The students were asked to learn with the digital game-based inquiry learning environment; that is the game led the students to explore factors of energy consumption, and guided them to construct their own conceptual knowledge via asking questions during playing game. Before participating in learning unit/game, the students were asked to take pre-conceptual test of the topic. After finishing learning activities on the game learning environment lasted 90 minutes in a time, they were asked to take post-conceptual test followed by

attitude questionnaire. They were asked to respond questionnaire only one time after finishing post-conceptual test.

4.2 Research Tools

To examine the first research hypothesis (H1), the research tools were a pre-conceptual test and a post-conceptual test; both of them were designed by three experienced teachers teaching same subject. Each test contained 20 multiple-choice items, and one point was scored for each correct answer; therefore, the total score of the tests was 20. The pre-conceptual test was evaluated the validity by three experienced teachers, and had the reliability value 0.63, implying that the test was reliable. Similarly, the post-conceptual test was evaluated the validity by three experienced teachers, and had the reliability value 0.60, implying that the test was reliable.

To investigate the other three hypotheses (H2, H3, H4), the attitude questionnaire was adopted from Giannakos (2013). In this study, there were 10 items in three factors of the questionnaire: Enjoyment (four items), Inquiry (three items), and Intention to Use (three items) as shown in Table 2. This questionnaire was measuring using a 5-points Likert scale ranging from “1 = strongly disagree” to “5 = strongly agree”. This questionnaire showed that the Cronbach’s alpha reliability value was 0.74, implying that the questionnaire was reliable.

Table 2: The research factors and their corresponding items

Factors	Definition	Items
Enjoyment (ENY)	The degree to which the learning sequence of using the digital game-based inquiry learning is perceived to be personally enjoyable.	<i>Item1</i> : Participating is more interesting using the digital game-based inquiry learning. <i>Item2</i> : Using the digital game-based inquiry learning is fun. <i>Item3</i> : I like using the digital game-based inquiry learning. <i>Item4</i> : I enjoy those aspects of my studying that require me to use the digital game-based inquiry learning.
Inquiry (INQ)	The degree to which the learning activity of using the digital game-based inquiry learning is perceived to be personal inquiry.	<i>Item5</i> : Using the digital game-based inquiry learning does help me explore factors of energy consumption. <i>Item6</i> : Using the digital game-based inquiry learning does help me construct my own knowledge. <i>Item7</i> : Using the digital game-based inquiry learning does help me building confidence in finding conceptual understanding of energy consumption clearly.
Intention to Use (IU)	The degree of students’ willingness to play the digital game-based inquiry learning.	<i>Item8</i> : I plan to use the digital game-based inquiry learning for studying in the future. <i>Item9</i> : I intent to continue using the digital game-based inquiry learning for studying in the future. <i>Item10</i> : I expect my use of the digital game-based inquiry learning to continue in the future.
Learning Progression (LPRO)	The level of students’ conceptual knowledge gained using the digital game-based inquiry learning.	The conceptual tests

5. Results

5.1 Students' conceptual learning progression

The result of the first research hypotheses (H1): students' conceptual learning progression through Digital Game-based Inquiry Learning has medium gain size or high gain size is taken to be the average normalized gain $\langle g \rangle$ by analyzing the conceptual pre-test and post-test. Hake (1998) defined the $\langle g \rangle$ as "High gain, $\langle g \rangle \geq 0.7$ ", "Medium gain, $0.7 > \langle g \rangle \geq 0.3$ ", and "Low gain, $\langle g \rangle < 0.3$ ". From sixty-six students' conceptual pre- and conceptual post-test scores, the results show that there are 13, 34, and 19 students for high, medium, and low gains respectively. For overall result, as shown in Table 3, the conceptual score of pre- and post-test, the $\langle g \rangle$ is 0.46 indicating that the students have conceptual learning progression of their learning by gaining better conceptual knowledge after participating in the digital game-based inquiry learning environment. It is clearly that the progression of their conceptual knowledge has medium gain size which meets the H1.

Table 3: Learning progression of conceptual score by the average normalized gain $\langle g \rangle$

Conceptual test (Total score = 20)	N	Mean	S.D.
Pre-test	66	7.56	2.30
Post-test	66	13.26	3.07
$\langle g \rangle$		0.46	

According to Table 3 results, this result suggests that learning with the developed digital game-based inquiry learning impacted moderately on improving the students' conceptual understanding of energy consumption. As now we have proven the value of the digital game-based inquiry learning on conceptual learning progression. We will answer the other three hypotheses (H2, H3, H4) to identify which factors of the developed game influences students' conceptual learning progression.

5.2 Students' attitudes affecting conceptual learning progression

To examine the research hypotheses regarding the effect of ENJ, INQ, and IU on students' LPRO, we divided ENJ, INQ, and IU on high and low categories performing by progression size; then performing a *t*-test including students' LPRO as a dependent variable and the other three factors (ENJ, INQ, IU) as independent variables. As shown in Table 4, we can see that INQ has significantly effect on students' LPRO, with a significant level of 0.05, while ENY and IU have not.

Table 4: Research hypotheses (H2, H3, H4) testing using *t*-test

Dependent variable	Independent variable	Categories progression gain size		<i>T</i>
		Low Mean (S.D.), interpretation	High Mean (S.D.), interpretation	
Learning progression (LPRO)	Enjoyment (ENY)	4.46 (0.35), strong agree	4.63 (0.32), strongly agree	1.56
	Inquiry (INQ)	3.92 (0.64), strong agree	4.77 (0.44), strongly agree	3.81*
	Intention of Use (IU)	4.57 (0.42), strongly agree	4.67 (0.41), strongly agree	0.66

* $p < 0.05$

Although we notice that only INQ has the significant effect on students' LPRO, observing Table 4, we must acknowledge that there is higher effect of IU than ENY. This indicates that the decision of students to use a digital game is higher effect than the enjoyment experienced through a

digital game on influencing the learning progression. Overall, Figure 1 clearly shows the positive influence of ENY, INQ, IU on students' LPRO in which we can answer the research hypotheses (H2, H3, H4).

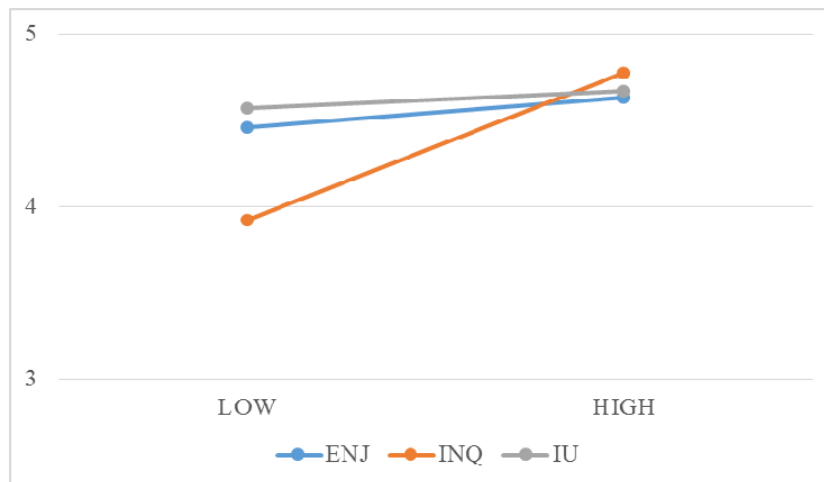

Figure 1. The effect of students' attitudes in their conceptual learning progression gain size when playing the digital game-based inquiry learning

We can see that the three factors (ENY, INQ, IU) affect the students' LPRO in the different way. As such to verify the strength of the relationship between factors, we used Pearson's coefficient as shown in Table 5. Clearly, there is relatively strong relation among three factors. This indicates that students reflecting high enjoyment are more likely to explore knowledge by themselves through the game; students reflecting high intention to use the game are more likely to be enjoyment during learning; and also a digital game reflecting high inquiry-based activity are more likely to influence decision of students to use a digital game.

Table 5: Pearson's correlation coefficient between factors (ENJ, INQ, IU)

Factors	ENY	INQ	IU
ENY	1		
INQ	.492*	1	
IU	.549*	.592*	1

*Correlation is significant at the 0.01 level

6. Discussion and Conclusion

This study examined the effectiveness of a digital game-based inquiry learning at the conceptual learning progression of energy consumption competences with the students of eastern Bhutan secondary school. From the conceptual tests, this study indicates that the developed digital game-based inquiry learning successfully improved students in Physics course. This result leads us to investigate the relationship between students' attitudes (Enjoyment, Inquiry, Intention to Use) and conceptual learning progression gain size regarding digital game-based inquiry learning. The findings indicated that Inquiry has a significant effect on students' conceptual learning progression. Thus, we could suggest that Inquiry: the degree to which the learning activity of using the digital game-based inquiry learning is perceived to be personal inquiry could play a very crucial role in acquiring conceptual knowledge of students. On the other hand, the hypotheses H2 and H4 are rejected. As such, students' enjoyment and intention to use indicate that there is no significant effect on students' conceptual learning progression. Our study is also similar with several studies (Sumak, Hericko and Pusnik, 2011; Giannakos, 2013) that also deal with the effect of students' attitudes (Enjoyment, Intention to Use) on learning performance when using digital games. Moreover, our study clearly

indicate the important roles of Enjoyment, Inquiry, Intention to Use in affecting the students' decision to use the digital game-based inquiry learning (Table 5).

The research findings revealed that students reflecting high inquiry are more likely to gain conceptual knowledge through the digital game. As such, educators, researchers, and practitioners should provide a learning environment where inquiry feature is supported and fostered in order to enhance successful conceptual learning progression with the digital game. If we overlook students' inquiry feature, it might have unfavorable effects on the conceptual knowledge constructing led to the conceptual knowledge progression.

Acknowledgement

This research project is supported by Thailand International Cooperation and Development Agency (TICA) scholarship.

References

- Aggul., F., Yalcin., M., Acikyildiz., A., & Sonmez, E. (2008). Investigation of effectiveness of demonstration simulation based instruction in teaching energy conservation at 7th grade. *Journal of Baltic Science Education*, 7(2), 64–78.
- Bates, T. (2003). *Effective teaching with technology in higher education: foundations for success* (1st ed.). San Francisco, CA: Jossey-Bass.
- Boyde, S. (2002). Green lubricants. Environmental benefits and impacts of lubrication. *Green Chemistry*, 4(4), 293–307.
- Cai, Y., Lu, B., Zheng, J., & Li, L. (2006). Immersive protein gaming for bio edutainment. *Simulation & Gaming*, 37(4), 466–475.
- Charsky, D. & Ressler, W. (2011). “Games are made for fun”: lessons on the effects of concept maps in the classroom use of computer games. *Computers & Education*, 56, 604–615.
- Chuang, T. Y. & Chen, W. F. (2009). Effect of computer-based video games on children: an experimental study. *Educational Technology & Society*, 12(2), 1–10.
- Davis, F. D., Bagozzi, R. P., & Warshaw, P. R. (1992). Extrinsic and intrinsic motivation to use computers in the workplace. *Journal of Applied Social Psychology*, 22, 1111–1132.
- DeWaters, J. E., & Powers, S. E. (2011). Improving energy literacy among middle school youth with project-based learning pedagogies. In *Frontiers in Education Conference (FIE)*, 2011 (p. T1D–1).
- DiCarlo, S. E. (2009). Too much content, not enough thinking, and too little FUN!. *Advances in Physiology Education*, 33(4), 257–264.
- Duit, Reinders. (1981). Students' notions about the energy concept-before and after Physics instruction. *Proceedings of the International Workshop “Problems Concerning Students” Representation of Physics and Chemistry Knowledge*, 19, 59 – 66.
- Eck, R. V. (2006). Digital Game- Based Learning: It's Not Just the Digital Natives Who Are Restless. *EDUCAUSE Review*, 41(2), 16–30.
- Gee, J. P. (2006). Are video games good for learning? Presented at the Curriculum Corporation 13th National Conference, Adelaide.
- Giannakos, M. N. (2013). Enjoy and learn with educational games: Examining factors affecting learning performance. *Computers and Education*, 68, 429–439.
- Gustafson, K. L., & Branch, R. M. (2002). *Survey of instructional development models* (4th ed.). Syracuse, N.Y: ERIC Clearinghouse on Information & Technology.
- Ha, I., Yoon, Y., & Choi, M. (2007). Determinants of adoption of mobile games under mobile broadband wireless access environment. *Information & Management*, 44(3), 276–286.
- Hake, R. (1998). Interactive-engagement vs traditional methods: A six-thousand-student survey of mechanics test data for introductory physics courses. *American Association of Physics Teachers*. 66, 64–74.
- Hsu, C. L., & Lu, H. P. (2004). Why do people play on-line games? An extended TAM with social influences and flow experience. *Information & Management*, 41(7), 853–868.
- Krajcik, J. S., & Blumenfeld, P. C. (2006). Project-based learning. In R. K. Sawyer (Ed.), *The Cambridge handbook of the learning sciences* (pp. 317–334). New York: Cambridge.
- Kubicek, J. P. (2005). Inquiry-based learning, the nature of science, and computer technology: New possibilities in science education. *Canadian Journal of Learning and Technology*, 31(1).

- Kuhn, D., Black, J., Keselman, A., & Kaplan, D. (2000). The development of cognitive skills to support inquiry learning. *Cognition and Instruction, 18*(4), 495–523.
- Kurt, S., & Ayas, A. (2012). Improving Student's Understanding and Explaining Real Life Problems on Concepts of Reaction Rate by Using a Four Step Constructivist Approach. *Energy Education Science and Technology Part B: Social and Educational Studies, 4*(2), 979–992.
- National Research Council (U.S.), & National Research Council (U.S.). (2000). *How people learn: brain, mind, experience, and school* (Expanded ed.). Washington, D.C: National Academy Press.
- Ozmen, H. (2008). Turkish Primary Students' Conceptions about the Particulate Nature of Matter. *International Journal of Environmental & Science Education, 3*(3).
- Papastergiou, M. (2009). Digital Game-Based Learning in high school Computer Science education: Impact on educational effectiveness and student motivation. *Computers & Education, 52*(1), 1–12.
- Prensky, M. (2007). *Digital game-based learning*. St. Paul, Minn.: Paragon House.
- Spraggins, C. C., & Rowsey, R. E. (1986). The effect of simulation games and worksheets on learning of varying ability groups in a high school biology classroom. *Journal of Research in Science Teaching, 23*(3), 219–229.
- Sumak, B., Hericko, M., & Pusnik, M. (2011). A meta-analysis of e-learning technology acceptance: the role of user types and e-learning technology types. *Computers in Human Behavior, 27*(6), 2067–2077.
- Wang, L. C. & Chen, M. P. (2010). The effects of game strategy and preference-matching on flow experience and programming performance in game-based learning. *Innovations in Education and Teaching International, 47*(1), 39–52.
- Venkatesh, V., & Bala, H. (2008). Technology acceptance model 3 and a research agenda on interventions. *Decision Sciences, 39*(2), 273–315.
- Vorderer, P., Klimmt, C., & Ritterfeld, U. (2004). Enjoyment: at the heart of media entertainment. *Communication Theory, 14*(4), 388–408.
- Yang, J. C., Chien, K. H., & Liu, T. C. (2012). A digital game-based learning system for energy education: an energy conservation pet. *The Turkish Online Journal of Educational Technology, 11*(2), 27-37.
- Yuenyong, C., Jones, A., & Sung-Ong, S. (2011). *Student Energy Conceptions*. In Science Education in International Contexts (pp. 3–16). Springer.

Revised Computer Game Attitude Scale

Maiga CHANG^{a*}, Rita KUO^b & Eric Zhi-Feng LIU^c

^a*School of Computing and Information Systems, Athabasca University, Canada*

^b*Knowledge Square Ltd., Taiwan*

^c*National Central University, Taiwan*

*maiga.chang@gmail.com

Abstract: In order to fit students' needs, an accurate computer game attitude scale is needed so teachers and researchers can know among their students who can really benefit from the use of educational games. In this paper, the research team analyzes 218 students' responses of a revised computer game attitude scale and finds their computer game attitude relationships and differences among gender, grade, preferred gaming way and game playing experience.

Keywords: Educational games, gender issue, elementary school students, post-secondary school students

1. Introduction

Most games are in some way educational, even if they have not been originally designed to be. When the games are played, the games can introduce new concepts or reinforce existing ones for players. Consider a deck of cards. There are literally thousands of card games that can be played. In most card games players need to know basic matching skills to match card denominations or suits; card denominations are often added together, requiring math skills. Often cards must be counted and matched, requiring counting (Cribbage, 2013; War, 2013), matching (Go Fish, 2013; Rummy, 2013) and more complex mathematical skills (Contract Bridge, 2013; Cribbage, 2013).

More and more games are designed for teaching and learning in the last decade (Fletcher & Tobias, 2006). Many researchers believe that students can learn in a leisure and friendly environment (i.e., game) if the game is designed for specific learning subject (Gee, 2003; van Eck, 2007). Furthermore, researchers also find out that educational games can help students learning complex contents such like activities of daily living (Kuo, Chang, Lyu, and Heh, 2013), algebra cognition (Corbett, Koedinger, & Handley, 2001), financial concepts (Jones, Chang and Kinshuk, 2014), history and culture (Ardito, Costabile, De Angeli, 2012; Chang & Chang, 2006; Garzotto, 2007), logic (Lanzilotti and Roselli, 2007), management information systems (Lu, Chang, Kinshuk, Huang, and Chen, 2014), programming language (Kahn, 1999; Kuo, Chang, Kinshuk, and Liu, 2010), and help elders with disabilities to improve selective attentions and to gain higher quality of life (Chen, Chiang, Liu, and Chang, 2012) as well as encouraging young females to do physical activity (Huang, Hung, Chang, and Chang, 2009). All experiments and pilots of educational games do show positive and encouraging outcome (Kapp, 2012; Prensky, 2007).

On the other hand, although many research find that there are gender differences on students' confidence in playing computer games and on how much students like computer games (Liu, Lee, and Chen, 2013; Lu, Chang, Kinshuk, Huang, and Chen, 2012), Lu and his colleagues (2012) have found that how students think about computer games and how comfortable they feel toward computer games are the two factors that significantly influence their voluntariness of using educational games. It is important to have an accurate measure for researchers and teachers getting clear idea of their students' attitude toward computer games, so proper supplemental learning tools like educational games can be offered to the right target – students who may really need and appreciate the alternative way of learning.

2. Computer Game Attitude Scales

Computer Game Attitude Scale (CGAS) is used to measure the player's attitude towards computer games. The scale was first introduced in 1997 and has proven to have strong validity and reliability in measuring attitudes (Chappell & Taylor, 1997). The CGAS has twenty items for testing two main subscales – comfort and liking. Liu and colleagues (2013) develop a New Computer Game Attitude Scale (NCGAS) by adopting items from Chappell and Taylor's CGAS and adding new items for new subscales and factors. There are sixty items proposed, in the NCGAS, for testing three subscales: cognition which includes two factors – learning and confidence; affection which includes liking factor; and, behavior which includes three factors – participation, leisure, and negative behavior). After validity and reliability tests, only twenty-two items kept in the final version of NCGAS questionnaire. The twenty-two items are used to examine three subscales (i.e., cognition, affection, and leisure) and five factors (i.e., learning and confidence in cognition subscale, liking in affection subscale, and participation and leisure in behavior subscale).

The research team further develops a revised CGAS based on NCGAS. As the NCGAS was developed for early adolescents, we remove some items according to the comments and suggestions made by research ethics review board and revise wordings of some items so the revised items can even be fully understood by Canadian children at ages 6 to 7 (i.e., 2nd grade elementary school students). There are seventeen five-point Likert-scale items (5 for "Strongly Agree" to 1 for "Strongly Disagree") proposed at beginning. The seventeen items are categorized into 4 factors listed below:

- Confidence: users' confidence in playing the computer game;
- Learning: users' perceptions of positive impact when computer games are used in learning;
- Liking: users perceived enjoyment for playing computer games;
- Leisure: users' thoughts on taking playing computer games as leisure activities.

Table 1: The proposed items of the revised Computer Game Attitude Scale.

Subscale	Factor	Item
Cognition	Confidence (CON)	1. I am good at playing computer games. 2. Playing computer games is easy for me. 3. I understand and play computer games well. 4. I am skilled at playing computer games.
	Learning (LRN)	1. I like taking courses that use computers. 2. Using computer games in school is a good way to learn. 3. Playing computer games improves my eye and hand coordination. 4. Playing computer games enhances my imagination.
Affection	Liking (LIKE)	1. I like it when people talk about computer games. 2. I feel comfortable while playing computer games. 3. I am very interested in solving quests/questions/missions in computer games. 4. I always try to solve the current quest/question/mission in the computer game.
Behavior	Leisure (LEI)	1. Playing computer games makes me happy. 2. Playing computer games is part of my life. 3. When I have free time, I play computer games. 4. I talk about computer games with my friends. 5. I am not alone in a computer game as I can make friends there.

Beside the seventeen items, in order to find out the differences among gender, grade, preferred gaming ways, and game play experience, additional twelve items are included – (1) one item for gender; (2) one item for grade; (3) three items for the preferred gaming ways include single player, limited multiplayer, and full functionality of multiplayer gaming; and, (4) seven items for amount of hours every day in a week the respondent usually spend on playing computer games.

3. Validity and Reliability of the Revised CGAS

Principal Component Analysis with varimax rotation is used to examine items' validity within the factors. Items with factor loading less than 0.6 were not good enough for presenting the factor (Hair, Anderson, Tatham, & Black, 1995). At the end, a valid and reliable revised computer game attitude scale with four factors and 17 items is determined and confirmed.

The cognition subscale is identified into Confidence and Learning factors. The reliability of the entire subscale is good as its Cronbach's alpha value is 0.882 (George & Mallery, 2010). Moreover, the reliability of Confidence factors is excellent (i.e., its Cronbach's alpha value is 0.936 and is larger than 0.9) and Learning factor is acceptable (i.e., its Cronbach's alpha value is 0.704 and is larger than 0.7). Table 2 lists the factor analysis results of the cognition subscale.

Table 2: Rotated factor loadings and Cronbach's alpha values of the cognition subscale of the revised Computer Game Attitude Scale.

Item	Factor 1: Confidence	Factor 2: Learning
Factor 1: Confidence (Cronbach's alpha = 0.967)		
CON3	0.936	
CON4	0.930	
CON2	0.921	
CON1	0.914	
Factor 2: Learning (Cronbach's alpha = 0.704)		
LRN2		0.795
LRN1		0.694
LRN4		0.670
LRN3		0.662
Eigenvalue	4.476	1.356
% of variance	55.955%	16.948%
Overall alpha = 0.882, Total variance explained is 72.903%		

The affection subscale only has one factor, Liking. The Cronbach alpha of the subscale is 0.748 and its reliability is acceptable. Table 3 lists the factor analysis result of the affection subscale.

Table 3: Factor loadings and Cronbach's alpha value for the affection subscale of the revised Computer Game Attitude Scale.

Item	Factor 1: Liking
Factor 1: Liking (Cronbach's alpha = 0.748)	
LIKE3	0.818
LIKE4	0.749
LIKE1	0.749
LIKE2	0.709
Eigenvalue	2.290
% of variance	57.242%

The last subscale, behavior, also has one factor, Leisure. The reliability of the subscale is also acceptable with its Cronbach alpha equals 0.754. The factor analysis results of the behavior subscale is listed in Table 4.

Table 4: Factor loadings and Cronbach's alpha value for the behavior subscale of the revised Computer Game Attitude Scale.

Item	Factor 1: Leisure
Factor 1: Leisure (Cronbach's alpha = 0.754)	
LEI2	0.829
LEI4	0.827
LEI5	0.802
LEI3	0.775
LEI1	0.744
Eigenvalue	3.167
% of variance	63.341%

The correlations among four factors are shown in the intercorrelation matrix in Table 5. All correlations in-between two factors are reached significance at level of 0.01. Moreover, the correlations in-between two subscales are also reached significance as the intercorrelation matrix in Table 6 shows. These two tables show that the three subscales and the four factors are coherent measurement in computer game attitude.

Table 5: Intercorrelation matrix of four computer game attitude factors.

Factor	CON	LRN	LIKE	LEI
CON	-	-	-	-
LRN	0.501**	-	-	-
LIKE	0.616**	0.569**	-	-
LEI	0.664**	0.649**	0.693**	-

** : Correlation is significant at the 0.01

Table 6: Intercorrelation matrix of three computer game attitude subscales.

Subscale	Cognition	Affection	Behavior
Cognition	-	-	-
Affection	0.683**	-	-
Behavior	0.753**	0.693**	-

** : Correlation is significant at the 0.01

Table 7 list the descriptive statistics of the three subscales and the four factors. The results show that students believe playing computer games is a good way for learning. Students are also enjoy in playing computer games and prefer playing computer games when they are free.

Table 7: Descriptive statistics of students' responses to the four factors and three subscales of the revised Computer Game Attitude Scale.

Subscale	Item Amount	Value Range	Mean	SD	Skewness
Cognition	8	1-5	3.950	0.889	-0.578
Affection	4	1-5	4.037	0.893	-0.863
Behavior	5	1-5	3.959	0.994	-0.779
Factor	Item Amount	Value Range	Mean	SD	Skewness
CON	4	1-5	3.798	1.236	-0.716
LRN	4	1-5	4.102	0.803	-0.532
LIKE	4	1-5	4.037	0.893	-0.863
LEI	5	1-5	3.959	0.994	-0.779

4. Differences among Gender, Grade, Preferred Gaming Way, and Game Playing

This research compares the scores of the four factors and the three subscales that students in different groups (e.g., gender, grade, preferred gaming way, and average hours of weekly game playing) respond. Table 8 shows the results of comparing male and female students' responses by using t-tests. Students' responses in all of the factors and the subscales show significant difference. The results show that male students have higher confidence in playing computer games and enjoy more on playing computer games when they are free. Male students also have higher perceptions of believing computer games can be a tool for learning.

Table 8: Gender differences to the factors in CGAS.

Factor	Gender	Mean	S.D.	t
CON	Female	3.348	1.356	-5.242**
	Male	4.194	0.965	
LRN	Female	3.985	0.844	-2.035*
	Male	4.206	0.753	
LIKE	Female	3.793	0.999	-3.818**
	Male	4.251	0.728	
LEI	Female	3.725	1.088	-3.275**
	Male	4.164	0.857	
Subscale				
Cognition	Female	3.668	0.942	-4.539**
	Male	4.199	0.760	
Affection	Female	3.793	0.999	-3.818**
	Male	4.251	0.728	
Behavior	Female	3.725	1.088	-3.275**
	Male	4.164	0.857	

*: Correlation is significant at the 0.05

**: Correlation is significant at the 0.01

We also divide data into two groups according to students' ages. The two groups are elementary school and post-secondary school. We use t-tests to check if there are differences in students' responses between the two groups. The results in Table 9 show that there are significant differences between the two. Elementary school students have more positive responses to all factors and subscales than post-secondary school students. The results show that elementary school students believe that they are good in playing computer games and treating playing computer games is an leisure activity. Elementary school students also believe that they can learn via the game-play of computer games. In other words, educational games may be appreciated much more for elementary school students.

In terms of preferred gaming way: there are 15.1% of students prefer to play computer games alone; 7.8% prefer to play computer games which have limited multiplayer features; 57.3% prefer to play multiplayer computer games; 1.8% prefer to play both of single player and limited multiplayer games; 0.9% prefer to play both of single player and full function multiplayer games; 3.7% prefer to play both of limited and full function multiplayer games; and, 2.3% enjoy all kinds of games. Table 10 lists the analysis results of the relations between preferred gaming way and the revised Computer Game Attitude Scale. The ANOVA and the Scheffe's tests results show that in terms of learning from playing computer games there is no significant difference among students' responses from different groups. On the other hand, we can find that students who prefer full function multiplayer games have more positive perceptions toward learning from playing computer games than their counterpart; for instances, group 3 vs. groups 1 and 2; group 4 vs. group 1; group 6 vs. group 2; and, group 7 vs. group 4.

Table 9: Grade differences to the factors in CGAS.

Factor	Gender	Mean	S.D.	t
CON	Elementary	3.954	1.281	3.301**
	Post-secondary	3.407	1.023	
LRN	Elementary	4.194	0.851	3.125**
	Post-secondary	3.871	0.614	
LIKE	Elementary	4.149	0.924	3.290**
	Post-secondary	3.754	0.745	
LEI	Elementary	4.055	1.062	2.647**
	Post-secondary	3.716	0.753	
Subscale				
Cognition	Elementary	4.074	0.917	3.673**
	Post-secondary	3.639	0.730	
Affection	Elementary	4.149	0.924	3.290**
	Post-secondary	3.754	0.745	
Behavior	Elementary	4.055	1.062	2.647**
	Post-secondary	3.716	0.753	

** : Correlation is significant at the 0.01

Table 10: Students who prefer different gaming ways have different responses toward the revised Computer Game Attitude Scale.

	CON	LRN	LIKE	LEI	Cognition	Affection	Behavior
Group 1 (1)	3.303 (1.536)	3.947 (0.922)	3.780 (1.121)	3.588 (1.184)	3.625 (1.108)	3.780 (1.121)	3.588 (1.184)
Group 2 (2)	3.559 (1.368)	4.147 (0.862)	4.000 (0.976)	3.882 (0.914)	3.850 (1.003)	4.000 (0.976)	3.882 (0.914)
Group 3 (3)	3.956 (1.057)	4.183 (0.726)	4.179 (0.740)	4.201 (0.830)	4.068 (0.752)	4.179 (0.740)	4.201 (0.83)
Group 4 (1)+(2)	2.563 (0.718)	3.375 (0.595)	2.896 (0.393)	2.863 (0.419)	2.969 (0.063)	2.896 (0.393)	2.863 (0.419)
Group 5 (1)+(3)	4.500 (0.707)	4.875 (0.177)	4.375 (0.884)	4.100 (1.273)	4.688 (0.442)	4.375 (0.884)	4.100 (1.273)
Group 6 (2)+(3)	4.469 (0.633)	4.531 (0.542)	4.563 (0.547)	4.400 (0.835)	4.500 (0.513)	4.563 (0.547)	4.400 (0.835)
Group 7 (1)+(2)+(3)	4.600 (0.894)	4.500 (0.707)	4.700 (0.671)	4.280 (0.820)	4.550 (0.758)	4.700 (0.671)	4.280 (0.820)
F	3.208**	1.910	3.345**	3.506**	3.429**	3.345**	3.506**
Scheffe test							

** : Correlation is significant at the 0.01

(1) prefer single player games; (2) prefer limited multiplayer games; and (3) prefer full function multiplayer games

Students spend time in playing computer games. Some of them spend less than two hours daily averagely and some may spend more than four hours a day. We divide the student responses to five groups according to how much time students spend on playing computer games daily. The five groups are: playing no computer game (8.3%), playing computer games less than 2 hours (33.5%), playing computer games 2 to 4 hours (25.7%), playing computer games 4 to 6 hours (12.8%), and playing computer games more than 6 hours (19.7%). The differences that students in different groups may have are also investigated in this research. Table 11 lists the results of comparing different group students' CGAS responses with ANOVA and the Scheffe tests. All of the factors and subscales have significant differences among the groups with level 0.01. Moreover, the Scheffe tests show that students spending more time in playing computer games may have higher score in Computer Game Attitude Scale.

Table 11: Students who spend different time daily in playing computer games have different responses toward the revised Computer Game Attitude Scale.

	CON	LRN	LIKE	LEI	Cognition	Affection	Behavior
Group 1 not playing	2.903 (1.632)	3.653 (0.879)	3.347 (1.287)	3.092 (1.158)	3.286 (1.073)	3.347 (1.287)	3.092 (1.158)
Group 2 less than 2 hours	3.26 (1.218)	3.894 (0.866)	3.817 (0.862)	3.641 (1.053)	3.575 (0.915)	3.817 (0.862)	3.641 (1.053)
Group 3 2 to 4 hours	4.232 (1.061)	4.304 (0.723)	4.296 (0.677)	4.224 (0.833)	4.268 (0.718)	4.296 (0.677)	4.224 (0.833)
Group 4 4 to 6 hours	4.152 (0.826)	4.241 (0.665)	4.089 (0.800)	4.121 (0.788)	4.198 (0.672)	4.089 (0.800)	4.121 (0.788)
Group 5 more than 6 hours	4.291 (0.965)	4.293 (0.705)	4.326 (0.837)	4.409 (0.735)	4.29 (0.698)	4.326 (0.837)	4.409 (0.735)
F	11.776**	4.626**	6.762**	10.134**	11.563**	4.626**	6.762**
Scheffe test	(3)>(1) (4)>(1) (5)>(1) (3)>(2) (4)>(2) (5)>(2)		(3)>(1) (5)>(1) (3)>(2) (5)>(2)	(3)>(1) (4)>(1) (5)>(1) (3)>(2) (5)>(2)	(3)>(1) (4)>(1) (5)>(1) (3)>(2) (4)>(2) (5)>(2)	(3)>(1) (5)>(1) (3)>(2) (5)>(2)	(3)>(1) (4)>(1) (5)>(1) (3)>(2) (5)>(2)

** : Correlation is significant at the 0.01

We also further investigate whether or not the time spent on playing computer games during weekdays and weekends have influence to the students' CGAS responses. During weekdays, there are 31.2% of students who do not play computer games, 38.5% of students spend less than 2 hours in playing computer games, 14.7% of students spend 2 to 4 hours in playing computer games, 7.3% of students spend 4 to 6 hours in playing computer games, and 8.3% of students spend more than 6 hours in playing computer games. Table 12 list the results of ANOVA and the Scheffe's tests. The results show that there is no significant difference in the responses to the Learning factor among groups. The Scheffe tests also show that less significant patterns among groups have found. However, in general speaking, the hardcore players do still have higher CGAS value than non-players (i.e., who play no computer games all the time no matter in weekdays or weekends) and leisure game players (i.e., who play computer games less or even not during weekdays but will play less than 2 hours or more in weekends).

For weekends, there are 22.9% of students who do not play computer games, 26.1% of students spend less than 2 hours in playing computer games, 17% of students spend 2 to 4 hours in playing computer games, 13.8% of students spend 4 to 6 hours in playing computer games, and 20.2% of students spend more than 6 hours in playing computer games. From the results of ANOVA and the Scheffe's tests listed in Table 13 we can see that all of factors and subscales have significant difference among the groups.

Table 12: Students who spend different time daily (during weekdays) in playing computer games have different responses toward the revised Computer Game Attitude Scale.

	CON	LRN	LIKE	LEI	Cognition	Affection	Behavior
Group 1 not playing	3.371 (1.331)	3.989 (0.798)	3.771 (1.055)	3.73 (1.09)	3.682 (0.949)	3.771 (1.055)	3.73 (1.09)
Group 2 less than 2 hours	3.628 (1.224)	4.012 (0.82)	3.976 (0.742)	3.805 (0.956)	3.818 (0.892)	3.976 (0.742)	3.805 (0.956)
Group 3 2 to 4 hours	4.359 (0.842)	4.32 (0.744)	4.292 (0.753)	4.166 (0.907)	4.341 (0.615)	4.292 (0.753)	4.166 (0.907)
Group 4 4 to 6 hours	4.531 (0.712)	4.505 (0.597)	4.281 (0.917)	4.388 (0.659)	4.515 (0.618)	4.281 (0.917)	4.388 (0.659)
Group 5 more than 6 hours	4.556 (0.942)	4.208 (0.871)	4.653 (0.67)	4.789 (0.533)	4.382 (0.679)	4.653 (0.67)	4.789 (0.533)
F	8.112**	2.338	5.046**	6.168**	6.910**	5.046**	6.168**
Scheffe test	(3)>(1) (4)>(1) (5)>(1)		(5)>(1)	(5)>(1) (5)>(2)	(3)>(1) (4)>(1) (5)>(1)	(5)>(1)	(5)>(1) (5)>(2)

*: Correlation is significant at the 0.05

**: Correlation is significant at the 0.01

Table 13: Analysis of average hour of daily game play in weekend and Computer Game Attitude Scale.

	CON	LRN	LIKE	LEI	Cognition	Affection	Behavior
Group 1 not playing	3.305 (1.323)	3.825 (0.708)	3.615 (0.976)	3.525 (0.92)	3.568 (0.883)	3.615 (0.976)	3.525 (0.92)
Group 2 less than 2 hours	3.272 (1.083)	3.904 (0.766)	3.73 (0.761)	3.597 (1.016)	3.588 (0.788)	3.73 (0.761)	3.597 (1.016)
Group 3 2 to 4 hours	3.696 (1.313)	4.088 (0.93)	4.187 (0.888)	4.041 (1.051)	3.887 (0.97)	4.187 (0.888)	4.041 (1.051)
Group 4 4 to 6 hours	4.5 (0.785)	4.408 (0.73)	4.425 (0.686)	4.187 (0.832)	4.452 (0.579)	4.425 (0.686)	4.187 (0.832)
Group 5 more than 6 hours	4.648 (0.767)	4.479 (0.694)	4.523 (0.715)	4.696 (0.545)	4.564 (0.604)	4.523 (0.715)	4.696 (0.545)
F	15.535**	6.478**	11.174**	13.187**	15.735**	11.174**	13.187**
Scheffe test	(4)>(1) (5)>(1) (4)>(2) (5)>(2) (4)>(3) (5)>(3)	(4)>(1) (5)>(1) (5)>(2)	(3)>(1) (4)>(1) (5)>(1) (4)>(2) (5)>(2)	(4)>(1) (5)>(1) (5)>(2) (5)>(3)	(4)>(1) (5)>(1) (4)>(2) (5)>(2) (5)>(3)	(3)>(1) (4)>(1) (5)>(1) (4)>(2) (5)>(2)	(4)>(1) (5)>(1) (5)>(2) (5)>(3)

**: Correlation is significant at the 0.01

5. Conclusion

This paper aims to provide researchers and teachers a valid and reliable revised Computer Game Attitude Scale which can be used even by children at their age of seven. Moreover, the findings of the differences among gender, grade, preferred gaming way, and game play experience, show that educational games may be appreciated by elementary school students and hardcore game players. Students who prefer to play full function multiplayer games seem to be more positive toward the idea of

learning from playing computer games. In the other words, an educational game may have higher usability and be accepted by students if it can have well-designed multiplayer functionality built-in. t

References

- Ardito, C., Costabile, M. F., de Angeli, A. (2012). Enriching exploration of archaeological parks with mobile technology. *ACM Transactions on Computer-Human Interaction*, 19(4), 1-30.
- Chang, A., & Chang, M. (2006). A Treasure Hunting Learning Model for Students Studying History and Culture in the Field with Cellphone. In Kinshuk, R. Koper, P. Kommers, P. Kirschner, D. G. Sampson, and W. Didderen (Eds.), *Proceedings of the 6th IEEE International Conference on Advanced Learning Technologies* (pp. 106-108). Los Alamitos, CA: IEEE.
- Chappell, K. K., & Taylor, C. S. (1997). Evidence for the Reliability and Factorial Validity of the Computer Game Attitude Scale. *Journal of Educational Computing Research*, 17(1), 67-77.
- Chen, S.-T., Chiang, I.-T., Liu, E. Z.-F., & Chang, M. (2012). Effects of Improvement on Selective Attention: Developing Appropriate Somatosensory Video Game Interventions for Insitutional-dwelling Elderly with Disabilities. *The Turkish Online Journal of Educational Technology*, 11(4), 409-417.
- Contract Bridge. (2014). Wikipedia. Retrieved May 26, 2014, from http://en.wikipedia.org/wiki/Contract_bridge
- Corbett, A. T., Koedinger, K. R., and Handley, W. (2001). Cognitive tutors: From the research classroom to all classrooms. In P. S. Goodman (Ed.), *Technology enhanced learning* (pp. 235-263). Mahwah, NJ: Lawrence Erlbaum.
- Cribbage. (2014). Wikipedia. Retrieved May 26, 2014, from <http://en.wikipedia.org/wiki/Cribbage>
- Fletcher, J. D., & Tobias, S. (2006). Using computer games and simulations for instructions: A research review. In *Proceedings of the Society for Applied Learning Technology Meeting*. Orlando, FL: New Learning Technologies.
- Gee, J. P. (2003). *What video game have to teach use about learning and literacy*. New York: Palgrave Macmillan.
- George, D., and Mallery, P. (2010). *SPSS for windows step by step: A simple guide and reference 18.0 update*, 11th ed., Boston: Allyn & Bacon.
- Go Fish. (2014). Wikipedia. Retrieved May 26, 2014, from http://en.wikipedia.org/wiki/Go_fish
- Garzotto, F. (2007). Investigating the educational effectiveness of multiplayer online games for children. In *Proceedings of the 6th international conference on Interaction design and children* (pp. 29-36). New York, NY: ACM.
- Hair, J. F., Anderson, R. E., Tatham, R. L., & Black, W. C. (1995). *Multivariate Data Analysis* (5th ed.). Upper Saddle River, NJ: Prentice Hall.
- Huang, S.-J., Hung, W.-C., Chang, M., & Chang, J. (2009). The Effect of an Internet-Based, Stage-Matched Message Intervention on Young Taiwanese Women's Physical Activity. *Journal of Health Communication*, 14(3), 210-227.
- Jones, D. A., Chang, M., & Kinshuk. (2014). Pecunia – A Life Simulation Game for Finance Education. *Research and Practice in Technology Enhanced Learning*, 9(1), 7-39.
- Kahn, K. (1999). A computer game to teach programming. Paper presented at the National Educational Computer Conference, Atalntic City, NJ.
- Kapp, K. M. (2012). *The Gamification of Learning and Instruction: Game-based Methods and Strategies for Training and Education*. San Francisco, CA: Pfeiffer.
- Kuo, R., Chang, M., Kinshuk, & Liu, E. Z.-F. (2010). Applying Multiplayer Online Game in Actionscript Programming Courses for Students Doing Self-Assessment. In S. L. Wong, S. C. Kong, and F.-Y. Yu (Eds), *Proceedings of Workshop on New Paradigms in Learning: Robotics, Playful Learning, and Digital Arts* (pp. 351-355). Serdang, Selangor, Malaysia: Faculty of Educational Studies, Universiti Putra Malaysia.
- Kuo, R., Chang, M., Lyu, C.-W., & Heh, J.-S. (2013). A Pilot Study of the Situated Game for Autistic Children Learning Activities of Daily Living. *Research and Practice in Technology Enhanced Learning*, 8(2), 291-315.
- Lanzilotti, R., & Roselli, T. (2007). An experimental evaluation of Logiocando – an intelligent tutoring hypermedia system. *International Journal of Artificial Intelligence in Education*, 17(1), 41-56.
- Liu, E. Z.-F., Lee, C.-Y., & Chen, J.-H. (2013). Developing a New Computer Game Attitude Scale for Taiwanese Early Adolescents. *Educational Technology and Society*, 16(1), 183-193.
- Lu, C., Chang, M., Kinshuk, Huang, E., & Chen, C.-W. (2012). Context-Aware Mobile Role Playing Game for Learning – A Case of Canada and Taiwan. In *Proceedings of Conference on Digital Game based Learning* (pp. 161-165), Hangzhou, China.
- Lu, C., Chang, M., Kinshuk, Huang, E., & Chen, C.-W. (2014). Context-Aware Mobile Role Playing Game for Learning – A Case of Canada and Taiwan. *Educational Technology & Society*, 17(2), 101-114.

- Prensky, M. (2007). *Digital Game-Based Learning*. Paragon House.
- Rummy. (2014). Wikipedia. Retrieved May 26, 2014, from <http://en.wikipedia.org/wiki/Rummy>
- van Eck, R. (2007). Building artificially intelligent learning games. In D. Gibson, C. Aldrich, & M. Prensky (Eds.). *Games and simulations in online learning: Research and development frameworks* (pp.271-307). Hershey, PA: Information Science.
- War. (2014). Wikipedia. Retrieved May 26, 2014, from [http://en.wikipedia.org/wiki/War_\(card_game\)](http://en.wikipedia.org/wiki/War_(card_game))

Why Are Schools Reluctant to Bring Higher-order Thinking Games to Classrooms?

Mingfong JAN

*Learning Sciences Lab, National Institute of Education, Nanyang Technological University,
Singapore*

mingfongjan@gmail.com

Abstract: In this conceptual paper, we analyze why schools are reluctant to bring higher-order thinking games to the classrooms. We use a role-playing mobile game designed for scientific argumentation—*Mad City Mystery*—to illuminate the complexity of the issue. We argue that the complexity arises at the design level, at the enactment level, and at an education system level as schools evaluate bringing a higher-order thinking game to a classroom. We maintain that these factors, as synthesized in Table 1, can be utilized as an essential check list for researchers, teachers, school leaders and policy makers when they consider designing and introducing higher-order thinking games to the classrooms.

Keywords: game-based learning, scientific argumentation, school innovation, ICT integration, 21st century competency

1. Games for learning: Promise and reality

Game-based learning surfaces as a promising solution to educational reform, especially for developing 21st century competencies (Shaffer, Halverson, Squire, & Gee, 2005). Indeed, game scholars in the 20th century did not miss the connection between games and learning. MIT researcher Malone (1980) was one of the pioneers to theorize the motivation aspects of game play and learning. Using games, or the concept of games, as learning approaches, however, did not gain momentum until Prensky and Gee. Prensky (2001) maintains that games motivate learners to learn deeper with its player-centered design. Gee (2003, 2007), arguing from a sociocultural perspective, maintains that “good” games can help people learn because they incorporate learning theories and cultural models. With the promotion and theorization from heavyweight scholars, game-based learning has become a popular research theme in the past decade.

Researchers are not the only ones intrigued by the mysterious power of games. While researchers are designing and theorizing games for learning, school practitioners in many parts of the world have already used games for learning in classrooms. In a 2011 survey by the Joan Ganz Cooney Center (Barseghian, 2012), 18% of the 505 K-8 United States teachers (mostly K-5th grade) use games in their classroom on a daily bases while half of them use digital games with their students two or more days a week. Nearly 70% of the participant teachers said that “lower-performing students engage more with subject content with use of digital games.”

In Asian countries such as Singapore, games emerge as an attractive approach for teaching and learning. In the Ministry of Education, a special task force is dedicated to game-based learning. Schools not only work with researchers to develop learning games (e.g., Jan, Chee, & Tan, 2010), but also utilize commercial off-the-shelf game engines and editors to design their own games for learning (e.g., "3DHive - Canberra Primary School," 2014)

Given the zeal in game-based learning across international boundaries and stakeholder communities, there are few reported cases in Asian schools that utilize games for historical thinking (e.g., Squire & Barab, 2004), place-based inquiry (e.g., Klopfer, 2008), scientific habit of mind (e.g., Steinkuehler & Duncan, 2008) or scientific argumentation (Squire & Jan, 2007)—all of them are higher-order thinking skills that can be viewed as 21st century competencies. While game scholars are urging schools to utilize games for deep learning (e.g., Gee, 2003), identity formation (e.g., Thomas & Brown, 2009), and even changes of discourse patterns in the classroom (e.g., Jan, 2010), schools are mostly using games for motivation, drilling and practices (Jan, 2013). Even when they use games for learning, it is rarely a sustainable practice (e.g., Chee, Tan, Tan, & Jan, 2012).

2. Why Are Schools Reluctant to Bring Higher-order Thinking Games to Classrooms?

Since games are a popular medium for learning and game-based learning is a proven approach for developing higher order thinking skills such as historic thinking and argumentation, why are schools reluctant to bring higher-order thinking games to classrooms?

This conceptual paper provides an analytic account for the above phenomenon. In particular, we tease out the major reasons that keep researcher-developed higher-order thinking games out of schools. To illustrate the case, we use *Mad City Mystery* (will be referred to as MCM hereafter), a scientific argumentation game designed by researchers (Squire & Jan, 2007), as an example to delineate pertinent issues that inhibit using games for higher order thinking skills in classrooms.

As a conceptual paper, this paper does not employ a standardized research paper structure commonly found in empirical studies. Instead, we describe the problem and build the argument with an authentic example—*MCM*. As the game designer and co-researcher of this game, I describe the game design and critical elements that enable the game a success in engaging students to practice scientific argumentation. After that, we re-situate the enablers in the classrooms in order to illuminate why schools may not utilize the game *as it is*. A similar writing approach is commonly adapted by education researchers such as the conceptual paper by diSessa and Cobb (2004) at the Journal of the Learning Sciences.

3. Case Selection Criteria

Why do we choose MCM to illuminate the issues pertaining to bringing higher-order thinking games to schools? *Mad City Mystery* (Squire & Jan, 2007), a role-playing mobile game designed to foster scientific argumentation skills by designing an authentic argumentation context, is an early proof of concept in game-based learning. It exemplifies how game-based learning may engage players in making scientific argumentation—a higher order thinking skill. The following reasons justify the case selection.

- 1) MCM is designed for a higher-order skill that is relatively common in the school syllabus. The curricular alignment makes it a plausible choice for schools to take up. The alignment with the science curriculum enables us to scrutinize reasons for not taking up the game.
- 2) A robust proof of concept is an important factor for schools to take up a learning game. MCM has clearly demonstrated the potential of game-based learning for a higher-order thinking skill.
- 3) The technology that enables MCM was novel when it was developed, but has become mature and readily available in the past few years.

The above criteria make MCM a plausible choice when schools consider using a learning game to foster scientific argumentation. In using MCM to make a case, we are able to exclude three major reasons that often prevent teachers from using a new technology in their classroom: curricular alignment, proof of concept, and technology integration (e.g., Cuban, 1986; Earle, 2002). In other words, the choice of the case enables us to highlight other factors that are equally critical, but often inconspicuous when it comes to bringing higher-order thinking games to classrooms.

4. MCM: A game-based learning model for scientific argumentation

MCM is a mobile game designed by researchers for scientific argumentation. With a location-sensitive technology developed by MIT (Klopfer, Squire, & Jenkins, 2004), Squire and Jan turned the physical space into an enormous game board. They employed game design principles such as role-playing, open-ended challenges, rich just-in-time contents delivery, to design a location-based game. Players role-play as teams of Environmental Specialist, Medical Doctor and Government Official. In uncovering the mysterious death of Ivan, they interview non-player characters (NPCs)

to collect qualitative and quantitative data. The data is designed based on argumentation theory such as Toulmin's (1958) argumentation pattern. The ultimate goal is to design an authentic context in the game so that it is essential for players to coordinate theory and evidence (Kuhn, 2005) while they investigate the mystery. The coordination of theory and evidence, based on Kuhn, is the core skill of scientific argumentation.

4.1 Briefing Session

The entire learning activity is composed of three activities that can be completed in 2~3 hours: pre-game briefing, gameplay, and post-game debriefing. The pre-game briefing familiarizes players with the game narrative, game interface and technology. Game play was initiated after the briefing when a team of three players (as a Medical Doctor, a Government Official and an Environmental Scientist) read about Ivan's death from their GPS-enabled mobile device.

4.2 Game Session

Ivan Ilyich is dead.

Police claimed that he drowned while fishing by the south shore of Lake Mendota.

Between January and the time of his death, Ivan put on 25 pounds and started drinking heavily. His health condition had deteriorated considerably.

As one of his friends, your task is to investigate the case with two of your best friends. It is your duty to present a clear picture about the causes and effects of these to the public.

The investigation of Ivan's mysterious death brought the team (composed of three players) into a complex system involving ecological, social, and cultural issues in Ivan's case. The success of the investigation relies on the players' ability to (1) critically filter the data they receive from the non-player characters (NPCs) in the game, (2) formulate hypotheses based on the collected data, and (3) revise/abandon hypotheses or construct new hypotheses when new data emerge. Through the entire game, players are immersed in (1) data collection at different physical locations and (2) the practices of coordinating theories and evidence. Figure 1 demonstrates how the non-player characters are designed to foster the argumentation among the players.

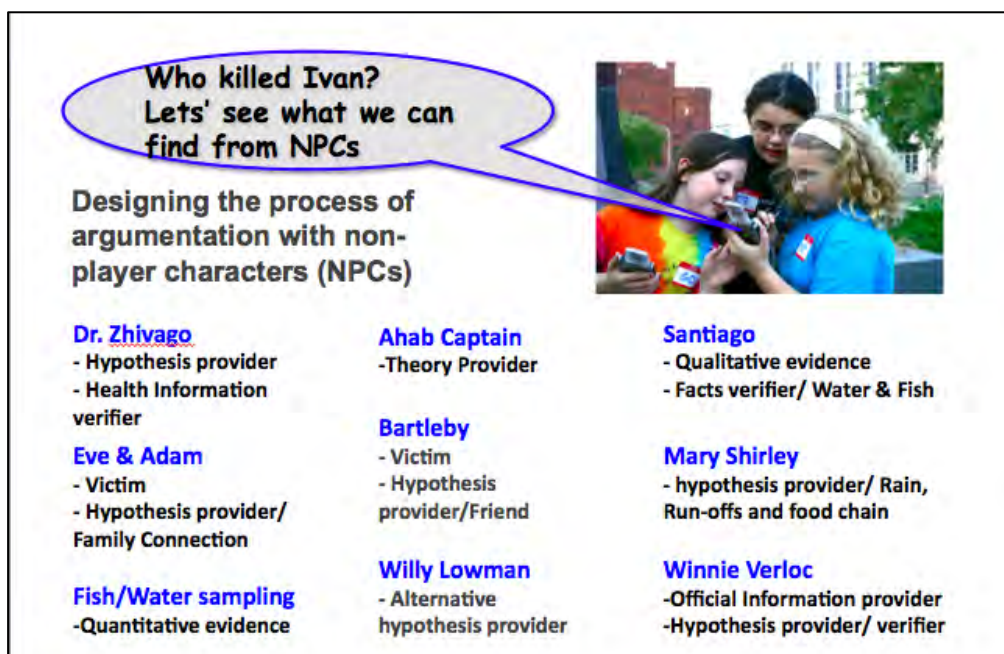

Figure 1: Designing non-player characters to foster the coordination of theory and evidence

Furthermore, the coordination of theories and evidence is a collaborative effort by design. Each player, depending on the role they play, only receives a subset of data. Unless they work with each other closely, each player can only develop a partial view of Ivan's case. In this process, team building is as critical as theory building if they want to solve the mystery.

During the game play, player teams often play at different paces due to various factors—collaboration skills, computer literacy, reading capabilities, observation of the physical space, to name just a few. Therefore, almost no teams finish the game at the same time.

At the end of the data collection, players need to ask more questions because the game never gives students sufficient data to come up with an absolute answer. The design goal is for them to develop multiple hypotheses and tell people which ones are more plausible. This is similar to multiple interpretations and debates about the extinction of dinosaurs in the science community.

4.3 Debriefing Session

In the debriefing session, players are first given thirty minutes to examine collected data and develop hypotheses as teams. After that, each team present their case to the Chief Investigator played by a researcher. What happened to Ivan Ilyich? How did he die and why should it be a concern to the public?

MCM was designed to with open-ended challenges—there are no “absolutely correct” answers that student players can identify in a content mastery paradigm. Players' performance is evaluated based on how well they are able to piece together relevant data and formulate evidence-based and plausible theories. The debriefing to the Chief Investigator is the assessment on the players. After the assessment, players are encouraged by the Chief Investigator to reconsider how they may come up with more robust theories or hypotheses about the above questions based on the collected data.

In a nutshell, *MCM* provides a *designed experience* (Squire, 2006) that is informed by theories about learning argumentation. The play experience is similar to the discourse practice commonly found in scientists' communities (c.f., Lemke, 1990; Gee, 2004)—debating the validity of data, making hypotheses, revising theories, and reporting findings.

4.4. Designing Argumentation Experience in Out-of-school and School Settings

MCM successfully create a *designed experience* where players develop argumentation skills via authentic discourse practices (e.g., Lemke, 1990) in an out-of-school setting. *What does it take to bring MCM to schools so that a similar designed experience can be achieved?* This is a question that we ask in the beginning of this paper. This is also a question that policy makers, school leaders, and teachers are most concerned about when they consider introducing learning games to the classrooms.

To unpack the question, we examine the *critical design elements* that enable the designed experience mediated by *MCM* in an out-of-school context. We then ask if the critical design elements can be replicated regularly in schools so that a similar designed experience can be achieved. Examining the efforts that it takes to bring *MCM* to the classroom enables us to pinpoint a set of *critical design constraints* that researchers, teachers, school leaders and policy makers should consider if the ultimate goal of designing a learning game and activities is to generate sustainable impacts to student learning in a school setting.

5. Critical Design Elements that enable *MCM* as a game for scientific argumentation

In the following, we enlist the **critical design elements** for *MCM* and re-situate them in a classroom setting. Doing so allow us to identify and examine the enablers for both contexts. Specifically, we will unpack these critical design elements from the (1) *game design stage* to the (2) *game enactment stage* in order to develop a systematic understanding.

5.1 Critical Design Elements in the Game Design Stage

In the *game design stage*, the critical design elements that enable the success of *MCM* are:

- 1) **Designing a learning experience that is informed by learning theories.** Integrating learning theories that inform how people develop argumentation in situ and game design principles are the most challenging design components in *MCM*. The designers of *MCM* not only design the game, but also the theory-informed play experience. To ensure a similar designed experience for scientific argumentation in the classroom, there is a need for teachers to be able to play a similar role that the researchers played—understanding the affordances of *MCM* and how to leverage its affordances for argumentation skills (Jan, 2009). Unfortunately, teachers are mostly trained as *content experts* rather than an *experience designers or facilitators*. Besides, the role change will have a deep effect on classroom management, discourse participation (e.g., O'Connor, & Michaels, 1996; Jan, 2009), teacher-student relationship (e.g., Frymier, & Houser, 2000) and other unexpected outcomes that teachers must be prepared for.
- 2) **The availability and affordability of technology.** The design of *MCM* was enabled by MIT's mobile augmented reality game engine/editor (Klopfer & Squire, 2008). The software technology and the digital device are critical enablers for a game like *MCM*. Though the technologies were not commonly seen in schools at the time *MCM* study was carried out, it has become mature and the infrastructure is in place for most schools in developed and some developing countries. In Singapore, many schools are currently using similar technology to develop learning trails for history, science and other subjects (e.g., So, Kim, & Looi, 2008). Even without the game engine/editor provided by MIT, there is a great chance that *MCM* can be reproduced using game engines available today. The real challenge, however, may not lie in the price tag. Whether the devices are easy to maintain and if the devices are used for multiple purposes are all practical issues that schools and policy makers must put into consideration.
- 3) **Flexibility in designing learning objectives and curricular structure.** *MCM* was designed for students to develop scientific argumentation skills—important 21st century literacy. As *MCM* was designed, the researchers were more concerned about the proof of concept. Designing a learning program not bounded by the formal school curriculum is a more feasible choice at a proof-of-concept stage. To bring *MCM* to the classroom, we must at least consider the following schooling-related constraints. The first and foremost is if developing scientific argumentation skill is a requirement in the curriculum. Even with scientific argumentation listed as an important learning objective, there is the issue of teaching approach and time allocated for developing argumentation skills. Fostering students' scientific argumentation skills require substantially more time than teaching what a scientific argumentation is using a direct instruction approach. In a content mastery learning paradigm, taking more time for the practices of scientific argumentation means less time for other content areas and therefore unexpected consequences if not planned well.
- 4) **Flexibility in choosing the learning sites.** To make *MCM* an authentic life experience game, the researchers utilize GPS-enabled technology to develop scientific argumentation skills. In *MCM*, the choice of game site is not a random choice because the problems players encounter in the game are also authentic problems commonly identified in the same physical space. Learning in the mainstream classrooms often assumes that learning in contexts (e.g., place experience) can be traded for convenience and efficiency (i.e., content mastery). To create a similar experience in schools, there is a need to “localize the game” based on the schools' location and the authentic problems to be solved near that location. This may post a tremendous challenge to schools if the goal is to recreate a similar authentic learning experience.
- 5) **Flexibility in designing alternative assessment.** In *MCM*, assessment is designed as students' team performance in the debriefing session. The goal is to identify the failure or mistakes that players make so that appropriate scaffolding can be provided. Players' performance is evaluated based on how they defend their hypotheses about Ivan's death. From there, the researchers could understand players' needs in

developing scientific argumentation skills. In other words, the assessment is designed to improve learning. In schools, assessments are often designed for multiple purposes. Unfortunately, many assessments, especially high-stake exams, are designed for *streaming* and *ranking*. Ranking students are so important that there is often a demand for new learning programs to have a quantifiable assessment before schools adapt them.

5.2 Game Enactment Stage

In the enactment stage, the critical design elements that enable the success of *MCM* are:

- 1) **Administrative and logistic support.** Before running the *MCM* game, there is a need to install software to all mobile devices, manage their updates, and make sure that they are all charged for game play. This is not a trivial task when there are 30~40 mobile devices to manage. When students play the game in an outdoor space, players' safety is always a concern especially for young kids who are concentrated on the mobile device. For a classroom with 40 students, there is a need to deploy 4~6 well-trained teachers to help manage game play during its enactment.
- 2) **Roles and social model.** *MCM* is a role-playing game with a unique social model designed into the practices of scientific argumentation. To play the game is to enact the embedded social model. It requires students and researchers to play roles that are quite different from their everyday identities. To enact the social model in a classroom, there is a need for the students to view themselves as professionals and inquirers. Shifting their identity from a student to a professional ensures the learning process to be more authentic. The identity shift can not be achieved without the researchers playing a counterpart. Creating a social model and fostering such an identity shift is perhaps more challenging in the classroom than in an outdoor space due to the established cultural model (e.g., Wegerif, Mercer, & Dawes, 1999) in the mainstream classrooms.
- 3) **Diverse learning pace.** To make *MCM* a successful learning experience, the research team allows the players to play at their own comfortable pace based on their needs and capabilities. Players interested in knowing more about water quality may spend more time observing water by the lake. Players who like to share may raise more questions when they collect new evidence. It is often not the case in a mainstream classroom, especially when developing cognitive abilities are placed on top of the learning hierarchy. Most classrooms have troubles accommodating students with diverse learning paces, not to mention diverse learning needs. This phenomenon has not changed much since Dewey (1956) comments on the compartmentation of subjects and grades in schools.

Table 1 summarizes the critical design elements for *MCM* and what it takes to enable them in schools.

Table 1 Aspects for considerations when we bring *MCM* from an out-of-school context to schools

Critical Design Elements	Challenges in bringing <i>MCM</i> to schools
1. Designing a game that is informed by learning theories.	Teachers are often trained as content experts and they mostly utilize direct instruction as a major pedagogical approach. To enact <i>MCM</i> , teachers need to understand how scientific argumentation skills are developed and play a mentor/facilitator role in guiding students. There is a need for professional development in the above areas.
2. The availability and affordability of technology	Although the technology that enables <i>MCM</i> is mature and affordable today, there is a need to consider if the technology is useful for other purposes and is easy to maintain.

3. Flexibility in designing learning objectives and curricular structure.	Developing higher order thinking skills requires guided participation through authentic practices. It takes significantly more time to develop. This creates a tension for a curriculum designed for <i>teaching</i> scientific argumentation instead of <i>practicing</i> argumentation.
4. Flexibility in choosing the learning sites.	<i>MCM</i> is designed based on problems authentic to the place where it is played. There is a need to localize the game at a different site in order to recreate similar authentic learning experience.
5. Flexibility in designing alternative assessment.	In <i>MCM</i> , the assessment is designed to help the researcher address issues of learning. In schools, assessments are often designed with ranking as the top priority. To design an assessment for learning and ranking at the same time is complex, and is often not achievable.
6. Administrative and logistic support.	Using digital technologies to support learning demands tremendous amount of administrative and logistic support. Given that resources are always limited, there is a risk of enabling <i>MCM</i> in schools at the price of other learning activities.
7. Roles and social model.	The researchers design a new social model to foster scientific argumentation. It can be a daunting challenge to promote this new social model in a classroom when there is already an established social model.
8. Diverse learning pace.	Schools demand students to learn with similar speed/pace, and the mainstream curriculum is designed with this assumption. Therefore, catering the needs of learners with diverse learning styles will be a critical concern for the game to be used in schools.

6. Why are schools reluctant to bring higher-order thinking games to the classrooms?

Based on the above analysis, we can further delineate the issues of brining a game like *MCM* to the classroom in three areas—*curricular*, *teaching* and *managerial*. Curricular issues refer to structural issues such as what to teach and how much time is allocated for teaching a topic. It is within the same category that the purposes of assessment are defined. Teaching issues refer to what teachers learn when they learn to teach and how they actually teach in the classrooms. Managerial issues refer to how resources are allocated to keep the system effective, such as teacher/student ratio, and the support given to teachers for teaching a subject. We find that in enabling *MCM* as a sustainable practice, all of the above practices face significant challenges. In a nutshell, there is misalignment lying at the system level if we wish to promote higher order thinking skills with games like *MCM*.

6.1 How should the analysis be interpreted?

In presenting these design challenges or design constraints, we do not maintain that higher order thinking games can be introduced in the classrooms because it requires substantial changes at a curricular, teaching and managerial level to sustain the *MCM* learning practices. We do not argue that we should keep the current education system intact because the price to pay is too great to be practical. *We ask readers not to view the condition as a dualistic choice.* Rather, the case presents a comprehensive view of the issues and complexities in introducing a higher order thinking game to the classroom. The complexity arises at the design level, at the enactment level and at a system level because the issue is not as simple as bringing a higher-order thinking game to a classroom. If fostering higher-order thinking skills is essential for a flat new world (Friedman, 2006; Shaffer & Gee, 2005), then there is a need to reconsider the major design assumptions underlying the current education system and why it is resilient to changes (Sarason, 1996).

6.2 How may the analysis inform practitioners and researchers when they bring/design higher order thinking games for sustainable changes?

We argue that the analysis above can also be viewed as an essential checklist for, teachers, school leaders, and policy makers when they consider bringing higher-order thinking games or other learning technologies to the classrooms. For researchers, this list will inform them to better define the *design constraints* if the ultimate goal is to bring their learning design to the classroom on a regular basis. For instance, the researchers may design card games informed by the *MCM* design principles as a way to minimize the pushbacks from the established learning system. It is useful for teachers to interrogate the changes they might have to make and the professional development they must go over before they take on this journey. School leaders and policy makers have more authority to redefine the constraints at different levels. Without fundamentally changing the education system, they could create alternative spaces within the system to slowly, but firmly and steadily, roll in new learning initiatives.

7. Contribution

This paper explicates the challenges and constraints of bringing higher order thinking games to schools from a design perspective. We scrutinize eight design constraints arising due to the change of design contexts—from an out-of-school setting to the mainstream schools—and the change of design objectives—from a proof of concept to everyday practices. By doing so, our contribution to the research community and stakeholders can be summarized as:

- 1) Presenting a holistic and comprehensive picture about the design constraints that game-based learning researchers must identify before they embark on designing learning games. There are researches that zoom into certain design constraints from different perspectives such as technology integration (e.g., Chai, Koh, & Tsai, 2010). Viewing from a design perspective enables the researchers and practitioners to consider the design constraints simultaneously from multiple levels—cognitive processes, tools, social models and systems. We argue that viewing these design constraints as a holistic and interwoven mechanism is a major contribution of this paper.
- 2) We explicate how “context” plays a critical role in designing games for learning. Our analysis highlights the design of a small “g” game and big “G” game at the same time. Drawing from Gee (2008), good game designers not only design the small “g” game—the software—but also the big G game—the social interaction taking place when the small “g” game is played. To play *MCM* in an out-of-school setting and schools, the same “g” game is identical while the big “G” game is different. This paper spells out some major factors that define the big “G” game in the mainstream schools.

8. Limitation

In crafting this conceptual paper with a case—*MCM*, we do not argue that all higher order thinking games will face identical design constraints when they are used in schools. Undeniably, a card game designed based on the same design principles may encounter different constraints. Nonetheless, there are system level constraints—such as teachers’ capacity—that are shared regardless the choice of media. We hope that there will be more studies about design constraints at different school systems. The better we are able to clarify the design constraints, the better we can pinpoint key design features at the early development stage.

References

- 3DHive - Canberra Primary School. (2014, August 11). Retrieved from <http://portal.3dhive.net/COMMUNITY/Games/TabId/170/PID/909/TagID/21/TagName/CanberraPrimarySchool/Default.aspx>
- Barab, S.A., Gresalfi, M.S., & Ingram-Goble, A. (2010). Transformational play: Using games to position person, content, and context. *Educational Researcher*, 39(7), 525-536.
- Barseghian, T. (2012, May 2). *New Report: Half of Teachers Surveyed Use Digital Games in Class / MindShift*. Retrieved from <http://blogs.kqed.org/mindshift/2012/05/new-survey-half-of-teachers-use-digital-games-in-class/>
- Chai, C. S., Koh, J. H. L., & Tsai, C. C. (2010). Facilitating Preservice Teachers' Development of Technological, Pedagogical, and Content Knowledge (TPACK). *Educational Technology & Society*, 13(4), 63-73.
- Chee, Y. S., Tan, K. C. D., Tan, E. M., & Jan, M. (2012). Learning chemistry performatively: Epistemological and pedagogical bases of design-for-learning with computer and video games. IN Tan, K. C. D. & Kim, M. (EDS.), *Issues and challenges in science education research: Moving forward* (PP. 245-262). Dordrecht: Springer.
- Cuban, L. (1986). *Teachers and machines: The classroom use of technology since 1920*. Teachers College Press.
- Dewey, J. (1956). *The child and the curriculum and the school and society*. Chicago: The University of Chicago Press.
- Earle, R. S. (2002). The integration of instructional technology into public education: Promises and challenges. *Educational Technology-Saddle Brook Then Englewood Cliffs Nj-*, 42(1), 5-13.
- diSessa, A. A., & Cobb, P. (2004). Ontological innovation and the role of theory in design experiments. *Journal of the Learning Sciences*, 13(1), 77-103.
- Friedman, T. L. (2006). *The world is flat: A brief history of the twenty-first century*. Macmillan.
- Frymier, A. B., & Houser, M. L. (2000). The teacher-student relationship as an interpersonal relationship. *Communication Education*, 49(3), 207-219.
- Gee, J. P. (2003). *What video games have to teach us about learning and literacy?* New York: Palgrave Macmillan.
- Gee, J. P. (2004). *Situated language and learning: A critique of traditional schooling*. London: Routledge.
- Gee, J. P. (2007). *Good video games + good learning: Collected essays on video games, learning and literacy*. New York, NY: Peter Lang Publishing.
- Gee, J. P. (2008). Learning and games. *The ecology of games: Connecting youth, games, and learning*, 3, 21-40.
- Jan, M. (2009). *Designing an Augmented Reality Game-based Curriculum for Argumentation*. Unpublished doctoral dissertation, University of Wisconsin-Madison.
- Jan, M., Chee, Y. S., & Tan, E. M. (2010). Learning science via a science-in-the-making process: The design of a game-based learning curriculum. In S. Martin (Ed.), *iVERG 2010 Proceedings – International Conference on Immersive Technologies for Learning: A multi-disciplinary approach* (pp. 13–25). Stockton: Iverg Publishing.
- Jan, M. (2013, December). *A Literature Review of Game-based Learning | SingTeach | Education Research for Teachers*. Retrieved from <http://singteach.nie.edu.sg/issue45-research02/>
- Klopfer, E. (2008). *Augmented learning: Research and design of mobile educational games*. MIT Press.
- Klopfer, E., & Squire, K. (2008). Environmental Detectives—the development of an augmented reality platform for environmental simulations. *Educational Technology Research and Development*, 56(2), 203-228.
- Kuhn, D. (1989). Children and adults as intuitive scientists. *Psychological Review*, 96(4), 674-689.
- Kuhn, D. (2005). *Education for thinking*. Cambridge, MA: Harvard University Press.
- Lemke, J. (1990). *Talking science: Language, learning, and values*. Norwood, NJ: Ablex.
- Malone, T. W. (1980). What makes things fun to learn? Heuristics for designing instructional computer games. In *Proceedings of the 3rd ACM SIGSMALL symposium and the first SIGPC symposium on Small systems* (pp. 162-169). ACM.
- O'Connor, M. C., & Michaels, S. (1996). Shifting participant frameworks: Orchestrating thinking practices in group discussion. *Discourse, learning, and schooling*, 63-103.
- Prensky, M. (2001). *Digital Game-based Learning*. New York: McGraw-Hill.
- Sarason, S. B. (1996). *Revisiting The Culture of the School and the Problem of Change*. New York: Teachers College Press.
- Shaffer, D. W. (2006). *How computer games help children learn*. Macmillan.

- Shaffer, D. W., & Gee, J. P. (2005). Before every child is left behind: How epistemic games can solve the coming crisis in education (WCER Working Paper): University of Wisconsin-Madison, Wisconsin Center for Education Research.
- Shaffer, D. W., Halverson, R., Squire, K. R., & Gee, J. P. (2005). Video Games and the Future of Learning. WCER Working Paper No. 2005-4. Wisconsin Center for Education Research.
- So, H. J., Kim, I., & Looi, C. K. (2008). Seamless mobile learning: Possibilities and challenges arising from the Singapore experience. *Educational Technology International*, 9(2), 97-121.
- Squire, K. D. (2006). From content to context: Video games as designed experiences. *Educational Researcher*, 35(8), 19-29.
- Squire, K., & Barab, S. (2004, June). Replaying history: Engaging urban underserved students in learning world history through computer simulation games. In *Proceedings of the 6th international conference on Learning sciences* (pp. 505-512). International Society of the Learning Sciences.
- Squire, K. D. & Jan, M. (2007). MCM: Developing scientific argumentation skills with a place-based augmented reality game on handheld computers. *Journal of Science Education and Technology*, 16(1), 5-29.
- Steinkuehler, C., & Duncan, S. (2008). Scientific habits of mind in virtual worlds. *Journal of Science Education and Technology*, 17(6), 530-543.
- Thomas, D., & Brown, J. S. (2009). The play of imagination: Extending the literary mind. In *After Cognitivism* (pp. 99-120). Springer Netherlands.
- Toulmin, S. (1958). *The uses of argument*. Cambridge: Cambridge University Press.
- Wegerif, R., Mercer, N., & Dawes, L. (1999). From social interaction to individual reasoning: an empirical investigation of a possible socio-cultural model of cognitive development. *Learning and instruction*, 9(6), 493-516.

An RPG Pattern for Ethical Gameplay in MAGNITUDE

Didin WAHYUDIN ^{a*1}, Shinobu HASEGAWA ^b

^a*School of Information Science, JAIST, Japan*

^b*Center for Graduate Education Initiative, JAIST, Japan*

*didin.wahyudin@jaist.ac.jp

Abstract: Disaster response works usually contain many problems, which need to be solved immediately. Most of such problems are consisted ethical matters. Therefore, it is essential for disaster responders having an awareness of ethical consideration to make decision accurately. To address such requirement, we designed a training game environment named MAGNITUDE. The game was proposed to improve non-technical skills, i.e. ethical decision-making. MAGNITUDE combined two types of game genre, simulation and role-playing game (RPG). By implementing simulation genre, it is expected to provide realistic-situation like disaster response. Whereas, by adopting RPG genre, we presume that MAGNITUDE encouraged a player to increase the level of his/her non-technical skill from a novice to an expert. In this paper, we explain the RPG pattern, which yields the ethical gameplay implemented in MAGNITUDE game.

Keywords: RPG Pattern, Ethical Gameplay, Ethical Dilemmas, Training Game, Simulation and Role-Playing Game.

1. Introduction

Disaster response works require personal skills in project management, teamwork, effective communication, and other soft skills. The disaster responder, therefore, should increase their soft skills regularly. However, it is difficult to create a realistic exercise due to limited environment. Training game is an approach to deal with the above issue. Researchers in this area found that games have the potential to enhance the training and performance of a disaster response team. Training games may improve the emergency team skill by providing regular training opportunities (Hullet & Mateas, 2009). The idea of enabling games as tools for education and training is not new. With decades of researches on game for learning, the games were usually developed for specific learning outcome, for example the games for emergency rescue and evacuation, emergency preparedness, and decision making (Campbell & Weaver, 2013). Training games takes benefits of gaming technologies for motivating, and interactive virtual learning environment that stimulates situated experiential learning.

The aim of this paper is to describe an RPG pattern in MAGNITUDE. Magnitude is a terminology to measure the earthquake scale. We named the game as MAGNITUDE, because we expect that the game can explode the player skill from a novice to be an expert. The game situates the natural post-disaster environment. It is intended to promote the player to have awareness of post-disaster setting and ethical tension appeared in such disaster response works. The structure of the discussion in this paper is as follows: In section 2, we firstly review the previous works concerning to the ethical model and game narrative. These works discovered that embedding ethical values into gameplay in MAGNITUDE is meaningful for encouraging the players to be aware of the real post-disaster situations. Section 3 explains the RPG design pattern. There are many patterns presented in the success commercial RPG, but we only discuss the specific patterns, which are suitable for ethical gameplay. We also discuss about a quest pattern in MAGNITUDE for transforming ethical values and judgment framework for assessing ethical decision. In section 4, we continue to discuss implementation of the proposed pattern. We finally conclude this paper in section 5.

¹ Didin Wahyudin is also with the Department of Electrical Engineering, Faculty of Technical and Vocational Education, Universitas Pendidikan Indonesia, Bandung, INDONESIA 40154, e-mail: deewahyu@upi.edu

2. Previous Work

2.1 Ethical Model in MAGNITUDE

Social and humanitarian action, such as emergency response of natural disaster, usually faces many problems. However, decisions made on a moral basis may have critical impacts on the societies. Ethics has been defined as the study of the general nature morality and the specific moral choices to be made by a person. Schrieber stated:

“Ethics refers to the study of systems of rules which are used to distinguish “right” actions—those which are ethical, moral, and valuable—from “wrong” actions. These systems are referred to as ethical systems, while specific rules that comprise an ethical system are called ethical principles” (Schreiber, Cash, & Hughes, 2011).

To embed ethical values, we pick up six components of moral intensity discovered by Jones, i.e. Magnitude of Consequence, Social Consensus Probability of Effect, Temporal Immediacy, Proximity, Concentration of Effect (Lincoln et al., 2011). We previously studied the model of game elements to implement them in MAGNITUDE (Wahyudin, Hasegawa, & Dahlan, 2013). Figure 1 shows the relationship between ethical components and others.

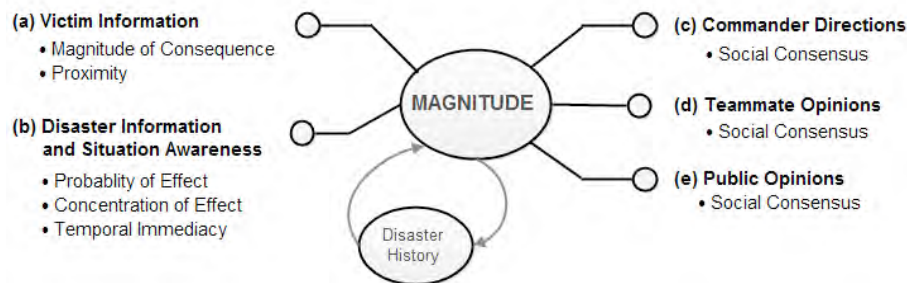

Figure 1. Ethical Model in MAGNITUDE

The following are MAGNITUDE elements. Some of them contain specific components of moral intensity:

- Victim Information is complete data, including the number of victims, illness involved, and social background. This element contains Magnitude of Consequence and Proximity. Knowing information of victims is necessary for the player to distinguish the victims who need immediate help or not.
- Disaster Information is data about the type, scale, and location of the disaster. Situation awareness is knowledge of the circumstances that will occur later. The elements consist of Probability of Effect, Concentration of Effect and Temporal Immediacy. By having an awareness of disaster situation, the player can estimate that the actions in disaster response are potential to affect the environment or community in short or long time span.
- Commander Directions are all advices from the disaster response commander related to the response stages. The commander has a duty to manage and direct the process of response. It is important to keep the process on the track of the actions plan, because the longer the process goes, the more difficult the commander sets up the next step.
- Teammate Opinions are comments or judgements from the other members of the team. As part of social collaborative teamwork, each member of the disaster response team has own rational thinking. Some of them have supporting argument, whereas the others dispute the player’s analysis.
- Public Opinions are comments and responses come from community and the victims to the action that has been carried out.

Commander Directions, Teammate opinions, and Public Opinions are MAGNITUDE elements, which contain Social Consensus.

2.2 Narrative of MAGNITUDE

MAGNITUDE is a game based training, which combined two genres of game, i.e. simulation and RPG. By implementing simulation, it provides the real-life disaster environment, such as flooding, earthquake, volcano eruption, and landslide. On the other hand, some literatures discovered that RPG is potential for teaching ethics and it can provide comprehensive ethical gameplay (Simkins, 2010). By incorporating RPG genre stimulate them to choose the best choice among ethical dilemmas that have emerged.

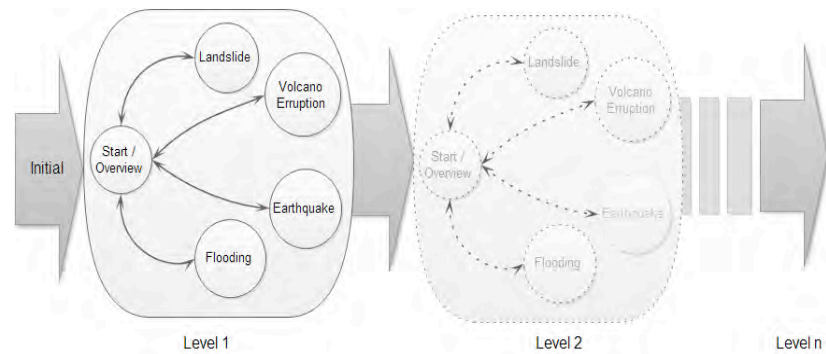

Figure 2. Model of MAGNITUDE Narrative

The main purpose of MAGNITUDE is to improve the skill level of the player from the novice to the expert. It takes place in the situations of post disaster, which player role is a member of a certain disaster response team (Wahyudin & Hasegawa 2014). Figure 2 illustrates the flow of the MAGNITUDE narrative. The game starts with an initial condition. Initial point demonstrates the opening narrative that shows the main character profile and roles. Each level contains branching narratives formed by four quests, which represent the types of disaster.

3. RPG Pattern

3.1 Applicable RPG Pattern

There are a lot of common patterns discovered from established RPG genre. However, in this paper we explain only the necessary patterns needed in MAGNITUDE. The followings are applicable patterns of RPG.

3.2 Character

A character is the game personality. The character may either controlled by the player, or by the computer. The character has characteristics, such as age, gender, strength, etc. that differentiates one by one. In a specific purpose, the character in MAGNITUDE can be classified into two classes, these are:

Classes of character based on type

- Player Character (PC): A PC in MAGNITUDE is named Pandu, which mean a boy scout. He is a teenager and a student in high school. He becomes an active student after joining a student organization at his school, which focuses on outdoor and humanitarian activities.
- Non-player character (NPC): NPC types can be distinguished into two categories. First NPC type is an interactive character, for example victim's family, and basecamp commander. Interactive character has the big contribution to present ethical tension and they will be involved in dialog trees. Another type is non-interactive character, with which the player cannot communicate with the others. Usually, non-interactive NPC is the only ornament for the game world.

Classes of character based on behavior

- **Protagonist:** This character has good behavior. The player usually acts as a protagonist.
- **Antagonist:** This character has bad behavior. Antagonist might come from the disaster response team or from the community. For instance, it always has a bad judgment to any actions taken by the player or annoys the main character actions.
- **Dynamic:** This character is usually an NPC appeared in all situations. In some situations the NPC expresses good behavior, but in another condition it conducts bad behavior or does not react anything to the main character.

3.3 Character Point

Character point is awarded to the player when he/she completes the quests, overcoming the obstacles. It is an incentive given to the player to encourage. It also performs the results of the activities' appropriate acquisition parameters. Character point in MAGNITUDE is determined by a combination of the following factors.

- **Success reward:** It is an incentive given to the player to encourage him/her show up the period and success to pass the difficulty or solve the problem.
- **Social Reward:** It is an incentive given to the player when the NPC was satisfied with his/her act. If he/she does satisfied job, the NPC will give him/her one point of Social Reward and vice versa.
- **Failure Reward:** It is negative rating given to the player when he/she commit to a fatal mistake.
- **Teammate Reward:** It is a satisfaction of the disaster response team when the player shows good collaborative works.

3.4 Hit Points

Hit Point is also known as Health or Life. The player's ones are status of the character's health during disaster response works. Doing a lot of work, he/she will lose his/her Hit Points. If his/her Hit Points decreases, he/she needs to add source of energy or take an enough rest. It can be added by earning food items found in the game world. For the NPCs of the disaster response team, Hit Points will lead to the slow of their response, and it is related to the mood of those NPCs. For the NPCs of the victims, once Hit Points lost rapidly, it will affect loss of the opportunity to save their life.

3.5 Resources

Resources are properties with limited quantity in the game world that the player may get, manage and consume in certain ways. For instance, he/she should find food to keep the energy in sufficient level. He/she may fight with the bad NPC to obtain the food items so that he/she can assure that his/her energy is maintained. On the other hand, if he/she discovers the victims who need food items, he/she can expend the reserved foods to help the victims' life.

3.6 Quest Pattern for Transforming Ethics Values

Quest provides the player with purpose and direction of the disaster response works. It also promotes him/her to explore the game world and make interaction with the NPC or static objects. The followings are typical patterns of RPG quest, which are possible to transform ethical values (Smith, 2011).

3.7 Actions

Actions are abstractions of the player's steps to complete the quests. For example, a quest which pushes him/her to do search and rescue operation when a natural disaster strikes. The player should distinguish between injured victims and died victims. The injured victims have priority to be evacuated than died victims. The following are elements of quest actions applied in MAGNITUDE.

- Options: It is the element which, the player will be confronted with the ethical dilemmas. Every option has Type and Outcome. Type is the kind of being made by the player such as, amputated victim's leg, destroyed hill, etc. Outcome is the result based on what the player opts.
- Equipment: It is a specific item needed to solve confronted problems. The variables of this element are the amount and function of them. For example, when the player discusses the response works, he/she will be asked to prepare safety equipment's and should determine and gather the necessary equipment related to the type of disaster.
- Moxie: The element pushes the player to use his/her personal knowledge to attain the objectives. This is a very important element in MAGNITUDE, because it endorses him/her to use his/her skills for making decisions rather than just exploiting the virtual skills of his/her character.

3.8 Objectives

Objectives are tasks needed to solve to complete the quest. The player will be assigned the main objectives, such as, determining the type and scale of the disaster, preparing emergency equipment, collecting the food items, searching and evacuating the victims, gathering information, and making decisions when response actions faced the dilemmas.

3.9 Quest Structure

Quest Structure causes the actions and the quest merging together. In MAGNITUDE, Quest Structure consists of:

- Ethical Dilemmas: The player will be confronted with the problems of search and rescue activities. Every problem contains at least one of six components of moral intensity.
- Deadline: It is a set amount of time. The player should complete the quest before it mechanically ends. If he/she cannot complete such tasks in a particular time, he/she will get the false point and the quests will be marked as failed.

4. Example of MAGNITUDE Quest

An example quest takes place in the situation of flooding disaster. Figure 3 shows narrative for this quest. The quest starts with a narrative that explains the objective of the quest. He/she requested to meet a commander (interactive NPC), who will guide the discussion to plan disaster response. He/she asked about disaster type, location and scale of the impacted area, and the number of the victims. To do quick response, he/she needs to determine the priority area, which area is fatal destruction. On the other hand, he/she should measure the possibility to save as much as possible the victims in this area.

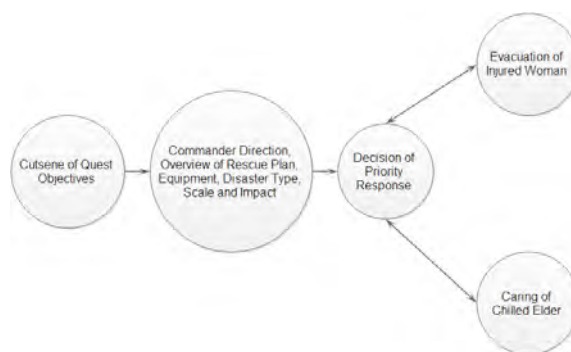

Figure 3. Flow of flooding quest

The player would continue to select priority of response actions. There are two jobs, i.e., caring the chilled elders, and evacuating the injured woman. In first location, there are many elders who need blankets and hot meals to prevent them from hypothermia. The problem is prepared blankets are not enough to meet the needs of all refugees. Some of the teens contend to get the blankets. Some of them have bad behavior that aggressive to annoy the player's act. However, if

he/she meets the teens' refugees who provide dialogue (interactive NPC), he/she can argue that they will survive without blankets. Now, he/she face the ethical problems associated to Proximity, which emotional and social closeness influence the decision to be taken. If he/she prioritizes the teens, elder refugees who cannot get the blankets will punish him/her with minus Social Reward. If the condition of elder refugees is critical, perhaps the refugees will lose their hit point. In this case, he/she will get Failure Reward. If he/she cannot satisfy the needs of teens' refugees, on the other hand, the refugees will stop to annoy the response activities, but the response action will be delayed and it causes the response team members or commander giving minus point of Teammate Reward.

Now we continue to see the next job at the location of the injured woman. There is an injured woman trapped under a collapsed bridge. Her leg was broken, and she is unconscious. Weather center reports that the heavy rain is happening in the headwaters area. In the next few hours, the river waves will be raised and lead to subsequent flooding. The player has a responsibility to evacuate the injured woman before next flooding hit this area. The problem is that he/she does not carry enough equipment to cross the river with a swift current. He/she can request to the command center to deliver required equipment, but it takes time because the injured woman needs help immediately. These circumstances give him/her Deadline. If he/she cannot evacuate, he/she will lose the opportunity to save the injured woman's life that perhaps break the woman family's hope. If woman's family felt let down, he/she will get minus point of Social Reward. On the other hand, because of its inability to evacuate on time, he/she loses the opportunity to save the woman. Hence he/she will get the Failure Reward.

5. Conclusion and Future Works

We have identified the RPG pattern of ethical gameplay. We found that the pattern of RPG applied to the example quest shows the game is potential to produce the meaningful of ethical gameplay. We are now working in progress of implementation of this pattern into complete playable game. However, there are still missing pattern for our research purposes. In the future, we expect to solve this weakness by studying other RPG patterns of established game. Another important work is to measure the effectiveness of the implemented pattern for training outcome through play testing of the playable game.

References

- Campbell, B., & Weaver, C. (2013). RimSim Response Hospital Evacuation: Improving Situation Awareness and Insight through Serious Games Play and Analysis. In M. Jennex (Ed.), *Using Social and Information Technologies for Disaster and Crisis Management* (pp. 132-146). Hershey, PA: Information Science Reference. doi:10.4018/978-1-4666-2788-8.ch009
- Hullett, K., and Mateas, M. (2009). Scenario generation for emergency rescue training games. In *Proceedings of the 4th International Conference on Foundations of Digital Games (FDG '09)*. ACM, New York, NY, USA, 99-106. DOI=10.1145/1536513.1536538 <http://doi.acm.org/10.1145/1536513.1536538>
- Lincoln, S. H., & Holmes, E. K. (2011). Ethical decision making: A process influenced by moral intensity. *Journal of Healthcare, Science and the Humanities*, I, pp. 1-15.
- Schreiber, I., Cash, B., & Hughes, L. (2011). Ethical Dilemmas in Gameplay: Choosing Between Right and Right. In K. Schrier, & D. Gibson (Eds.) *Designing Games for Ethics: Models, Techniques and Frameworks* (pp. 72-82). Hershey, PA: Information Science Reference. doi:10.4018/978-1-60960-120-1.ch005
- Simkins, D. (2010). Playing with Ethics: Experiencing New Ways of Being in RPGs. In K. Schrier, & D. Gibson (Eds.) *Ethics and Game Design: Teaching Values through Play* (pp. 69-84). Hershey, PA: Information Science Reference. doi:10.4018/978-1-61520-845-6.ch005
- Smith, G., Anderson, R., Kopleck, B., Lindblad, Z., Scott, L., Wardell, A., Whitehead, J., and Mateas, M. (2011). Situating quests: Design pattern for quest and level design in role-playing games. LNCS 7069, pp. 326-329, Springer-Verlag, Berlin Heidelberg.
- Wahyudin, D., Hasegawa, S., & Dahlan, T. (2013). Mobile game based learning to develop ethical decision making skill of novice volunteer in disaster response. Proceedings of The 21st International Conference on Computers in Education (ICCE 2013), Bali, Indonesia.
- Wahyudin, D., & Hasegawa, S. (2014). Game narrative to situate ethical dilemmas in virtual disaster response works. Proceeding of The 41st Conference of International Simulation and Gaming Association (ISAGA 2014), Dornbirn, Austria, pp. 611-623.

Aesthetic Design For Learning With Games

Diali GUPTA* & Beaumie KIM

Werklund School of Education, University of Calgary, Canada

*diali.gupta@ucalgary.ca

Abstract: This paper presents a design framework for educational games utilizing the notion of game aesthetics. Aesthetics in games is presently defined by all the facets of gaming experienced by players either directly through audio and graphics or indirectly through rules, geography, temporal characteristics and number of players. Researchers have observed that learning depends on the aesthetic qualities of an instructional environment and therefore the design of effective learning environments is dependent on its aesthetic considerations. Using the aesthetic principles of instructional design and the Design/Creativity loop model as the overall framework this paper elucidates how a game can be aesthetically conceived to reveal the core learning concepts and complexities for a deeper engagement with the content. To emphasize the role of creativity, we conceptualize the design process through a comparative analysis between choreography and the aesthetic configuration of a game based learning environment. We present and discuss the parallel processes of these two creative and iterative design activities, using various exemplary educational games and West African dance forms.

Keywords: Aesthetics, game based learning environments, choreography, creativity in design

1. Introduction

Although game based learning environments are recognized as good media for learning and socialization through the dimension of play (Van Eck, 2006), designing games for classroom use to advance cognitive development has been a challenge. In order for teachers to use games in the classroom, they not only need to consider students' level of engagement, motivation and prior knowledge but also ensure the alignment of the curriculum, pedagogical techniques and clear learning goals for games (Kirkland, Ulicsak & Harlington, 2010). Shute, Rieber and Van Eck, (2012) discussed that the hurdle faced with wider usage of games in classrooms is due to the lack of understanding of the gaming environments' effects on learning and a corresponding lack of theory and practice for their design and implementation. Educational games can often be ineffective if they fail to unpack the students' interests and extend them into the academic domain (Squire, 2011). We argue that learning becomes a meaningful experience when it is aesthetic in nature, and hence propose a reconceptualization of game design from an aesthetic perspective. An aesthetic learning experience is engaging, lends continuity to a learning process and is concerned with the qualitative meaning attributed to it (Parrish, 2009). Reemphasizing the importance of aesthetics in game design, Squire (2011) reiterates how design teams or designers must strive towards making game development an iterative or creative process with frequent prototyping and testing to create compelling educational experiences. We therefore advocate that game design as a process in itself has to be an aesthetic experience so that the designers engage in a creative process and are able to reflect their creativity through the aesthetics of game based learning environments.

2. Aesthetics and Creativity in Designing Game Based Learning Environments

An aesthetic experience is similar to being pulled out of one's subjectivity into a web of relations that demand his or her attention (Gadamer, 2011). An aesthetic understanding depends on the notion of play through participation, which is crucial for individuals in deciphering the ways of the world (Jardine, 2006). Egenfeldt-Nielsen, Smith & Tosca (2013) from a purely technical point of view, define aesthetics in games constitute the elements such as audiovisuals, rules, geography, temporal features and number of players, and how these work in unison to showcase the experience of "how it plays" (p.

117). Learning environments possess aesthetic qualities, which become evident through instructional activities or methods that foster intellectual and emotional tensions or through content and strategies that provide significant learning experiences (Wilson, 2005; Parrish, 2009). Aesthetic experiences within learning environments make the learning immersive, meaningful, coherent, complete and transformative (Parrish, 2009). Extending the notion to game based learning environments we suggest that aesthetics in games affects learning and plays a coherent role towards understanding the game (Gupta & Kim, 2014). In game based learning the learners derive the meaning from interacting directly with the gaming world and through observations of the consequences of their actions (Squire, 2011). The aesthetics of a game also captures the subjective experience and invokes the emotional response of the players (Aleven, Myers, Easterday & Ogan, 2010). Game design, which bring out the aesthetic qualities, is therefore of immense importance for facilitating learning and creating meaningful learning experiences.

Aesthetic qualities help to establish the theme of learning if the issues arising from the subject are part of the situation (Parrish, 2009). Elements such as rules or geography can help present the problem and the theme of learning. Aesthetic qualities such as patterns, routines or motifs help to see the connections or the changes thus supplying an anchor for new learning (Parrish, 2009). Aesthetic elements of a game similarly provide patterns, routines or motifs, which holistically reveal the changes and connections as the game progresses. Aesthetic elements, especially visual representations, are critical for making sense of a game: they not only communicate educational concepts and enable players to see patterns in the gaming process but also shape and reshape various game elements depending on the player's choices (Egenfeldt-Nielsen, Smith & Tosca, 2013; Squire, 2011). Aesthetic learning experiences also involve tension and anticipation in the course of clarifying a problem, making it challenging and engaging for learners (Parrish, 2009). We claim that aesthetic tension or anticipation arising out of the game elements can motivate the player impacting his or her critical thinking skills and emotions towards solving the problem (Gupta & Kim, 2014). We assert that creating a game based learning environment rich in aesthetics demands embodying the above mentioned aesthetical qualities in the design.

We also propose that the designers themselves have to undergo an aesthetical experience as instructional designers, to come up with creative designs for presenting a problem or a theme in a project. Hokanson and Miller (2009) suggested how designers have to be in a creative frame of mind for visualizing innovative ideas to commence and end the process of design. The Design/Creativity Loop Model (see Clinton & Hokanson, 2012) further develops the role of creativity by focusing on the various processes that take place during instructional design and development. The model illustrates an iterative process of creative thinking. The design process may commence with the problem identification or the creative vision and proceed to the preparation stage where the designer pursues supporting design tasks. Incubation involves creative endeavours of the designer while processing the design problems, which leads to illumination reflecting the designer's comprehension of solutions. These solutions are derived through repeated mental iterations, which the designer then builds upon or verifies through the design.

Creativity in game design must surface through a mix of the visual arts, the content and the connections to learning theory (Squire 2011). Drawing from Chen, Kasof, Himsel, Dmitrieva, Dong and Xue's (2005) notion of creative response, we propose that an instructional design of a game, which involves insightful problem identification, divergent and evaluative thinking, is bound to extract creative responses from the learners. An instructional design process can bear similarities to an artistic approach "since designers can actually devise specific instructional strategies and make aesthetic decisions" (Clinton & Hokanson, 2012, p.123). Choreography is a highly artistic and creative process of design. It is an integral part of performance arts and we have chosen to explain the game design process by drawing similarities between the processes. We use the Design/Creativity Loop Model to understand the fundamental process of creative design and devise our own model specifically for an aesthetic design of game based learning environments.

3. The Aesthetic Process of Designing a Game Based Learning Environment

Design requires creativity. Choreography often starts with an artistic intention, inspiration or vision and dwells on the possibility of finding novel solutions through a chain of reasoning (Pakes, 2009).

Choreography can emerge as an evidence of the synthesis of competing ideas such as problem finding, problem solving and metaphorical thinking (McKechnie & Stevens, 2009). The purpose of a choreographed dance therefore is to highlight an issue, express the process of resolving it and bring about a conclusive end to the narrative. The purpose of an educational game is similar: it identifies the issues in the context and engages players in the problem solving process within the game situation as the protagonist(s) in the narrative.

There are four creative operations of dance making – improvisation, development, evaluation and assimilation (Lavender, 2009). Improvisation begins with generating the artistic value of movements or dance structure ideas. Since it is exploratory, choreographers have to make critical choices about the form and structure of the movements based on their aesthetic values (Lavender & Predock-Linnell, 2001). The movements are then developed through the application of choreographic principles and devices. In order to infuse the movements with a particular energy or quality the choreographers may attend to the structural frames of the movements and alter the expressive details (Lavender, 2009). Choreographers then evaluate their actions and outcomes because choreography is a critical process that incorporates reflection, instantaneous or otherwise, to analyze, interpret and assess how the ideas are working towards shaping the dance (Lavender & Predock-Linnell, 2001). Finally choreographers assimilate all the materials they have composed to form smaller chunks that eventually coalesce into the fully formed dance, set for performance (Lavender, 2009). Thus choreographic approach remains entrenched in the aesthetic-artistic environment of the choreographers and goes through iterative stages of preparation, creative thinking and decision making regarding style, form, tempo or other characteristics. The final creative piece when woven together becomes an ensemble that has evolved as a dynamical system to communicate the flow of thought of the choreographer.

To understand how choreography bears similarities to the game design process we have devised a model (see Figure 1), drawing from key concepts of creativity in design (Clinton & Hokanson, 2012) and the creative operations of dance making.

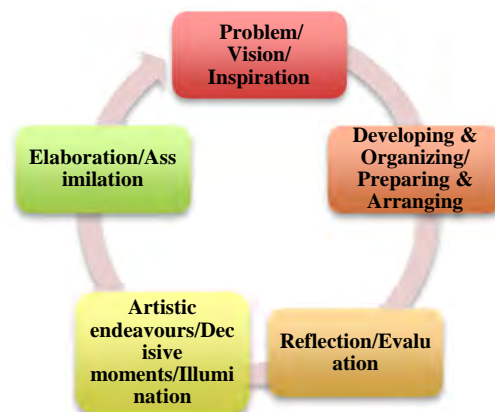

Figure 1. The Aesthetic Game Design Cycle

The aesthetic game design cycle is based on the creativity of the individual designers and is not prescriptive but descriptive towards reorienting the process of game design. Creativity as an iterative process involves divergent thinking and is grounded in everyday capacities such as association of ideas, perception, analogical thinking or reflective self-criticism (Boden, 1998). As a creative endeavour the Aesthetic Game Design Cycle is therefore repetitive and cyclical. Using the aesthetic principles for instructional design (Parrish, 2009) we now elaborate how the aesthetic elements of a game establish the theme, create sustained engagement and anticipation and emerge through patterns and motifs that mark progression and novelty.

3.1 Establishing the Game Theme

Inspiration for choreography can stem from a piece of music, a visual concept, image or perhaps an emotion or feeling (McKechnie & Stevens, 2009; Pakes, 2009; Smith-Autard, 2009; D.J. Walsh, personal communication, 26th April, 2014). In comparison, the game designer has to identify the problem first, wrap it contextually (Clinton & Hokanson, 2012) to express the complexity so that there

are divergent means of solving the problem. The theme of learning as an aesthetic principle concerns itself with the learning activity (Parrish, 2009). Learning activity in game based environments evolves through game play where the focus has been to narratize the discipline or the subject through a core problem so that the learners can engage in socio-scientific inquiry (Barab, Sadler, Heiselt, Hickey & Zuicker, 2010). The narrative therefore becomes a framework for the aesthetic principles of instruction as it helps to understand the theme, the subject or the problem that is presented through the game. Narrative is an important element of choreography as it helps to conceptualize the dance (Lavender, 2009). The mini narratives or intention framing exercises both in design and choreography, thus help to build the narrative.

The aesthetic elements of a game can bring out the theme by portraying the conflicting information or the tension as the narrative progresses. Elements of a theme are decipherable from the rules of dance forms (Pakes, 2009). Rules define what the style will be (example Jazz, West African or Contemporary), and depending on the style chosen the rules help to elaborate the theme by establishing the structure, form, tempo, time signature and characteristics of the dance (Lavender, 2009). Genres or types of games are similarly classified by rules, which define the basic structure of the game. Depending on the theme the designer may choose completely open-ended environments (*Assassin's Creed*) where the outcome of the game depends on the actions of the player or point and click games (*On the Ground Reporter, Darfur*) where the player's actions are guided by artificial intelligence. In traditional West African dance, a wedding dance like *Guinea Lamban*, performed separately by men or women has a unique rhythm and certain signature movements. In Africa, dance serves as an index to the value systems that enable the community to interpret and express the various events of life (Nii-Yartey, 2009). Based on some of these rules, the choreographer can portray the narrative by sequencing the steps, modifying the artistic movements through complexities within the steps. (D.J.Walsh, personal communication, 26th April, 2014). Different genres of games (simulation exercises, role-playing games, building games etc) have different sets of rules. The designer is guided by these rules but can be creative within the defined parameters.



Figure 2. Screen Shot (*Assassin's Creed*)



Figure 3. Cuban Dancers on Stage
(Photo courtesy of C. M. Constantinescu, 2014)

The choreographer or designer may choose to work on the geographical or spatial elements of the design for example (Lycouris, 2009; D.J.Walsh, personal communication, 26th April, 2014). The spatial arrangement can speak to the narrative and hence to the theme. The stage can be divided into halves or quadrants with site specific installations. Such arrangements play a crucial role in the choreographer's decision. For example it can be a piece in isolation or an invitation to the audience to be part of the world (see Figure 3). A designer can similarly conceptualize the geography or the physical landscape to portray the theme accurately and help create the mood for the story to unfold (see Figure 2). Just like in a dance piece, the game designer has the option to select the number of players depending on the theme (see Figure 3), adding a social component to the game.

3.2 Creating Sustained Engagement and Anticipation

Once the choreographer/designer goes through a number of iterations of the creative cycle to arrive at major decisions (Decisive moments stage) regarding the theme, the process of elaboration and assimilation of the theme commences for the entire dance form/the game design. During this stage the

choreographer/designer can revisit the design to verify and elaborate towards sustaining the engagement and anticipation of the audience/players as well as their own visions.

Sustained engagement can be achieved in a learning environment through enhancement of the complication by introducing new tensions or complexities (Parrish, 2009). The game designer can reconstruct the narrative to introduce complications and create small achievements towards anticipation. Maintaining such anticipation demonstrates unity in the learning process and helps towards consummation of learning (Parrish, 2009). Small-scale tensions and consummations can come alive through the choreographic elements of intrigue, resolve or surprise (Nii-Yartey, 2009). Such elements are woven in through the changes of dynamic in audiovisual representations incorporating movement, music and lighting (McKechnie & Stevens, 2009). The form, style, tempo, time signatures, specific movements, spatial arrangements and number of dancers help to elaborate these minor complications within the choreography. In a similar way game designers can build up mini complications through the audio-visual representations or the narrative by suddenly exaggerating problems that appeared earlier or by augmenting unexpected turn of events through the game play.

The designer(s), having a thorough understanding of the problem may be further inspired to embed emergent problems within the parameters (curriculum) of the content/subject. Such emergent problems may be conceived through self-perception or through influences of the socio-cultural perspectives of the designers. These conflicts or problems can help establish continuity for the game.

3.3 Using Patterns, Routines and Motifs to Mark Progress

Patterns, routines and motifs are aesthetic traits that help to comprehend connections in the theme or even the narrative. Without patterns, routines or motifs the context emerges as chaotic and the novelty of situation is lost in the process (Parrish, 2009). Patterns in choreography cultivate a sense of understanding of the theme by reemphasizing certain dance movements (D.J. Walsh, personal communication, 26th April, 2014). In games patterns, routines and motifs are yardsticks for measuring progress particularly the onset of new situations, changes and connections in the problem. Patterns or routines repeated over time or through the action of players may have special significance towards comprehending the theme or narrative. The designer can elaborate on the theme by initiating the patterns and routines to establish the sequence or growth in the narrative. Repetitive patterns in West African rhythms emphasize the organic flow of one movement to the other (Nii-Yartey, 2009) which introduces novelties and meaningful progression. Patterns can also be established in games using the rules, geography, characters, the tempo as well as through the music and visual artistry. In *On the Ground Reporter Darfur*, as the player travels to a new area, a certain piece of music is repeated to establish familiarity and progress.

3. Implication and Conclusion

Games, which have strong elements of aesthetics and are conceived through a creative process, enable the learners to come up with creative responses to the theme, content or problems. As the learners start making sense of the aesthetic elements they create their own framework, which define and shape their understanding. The aesthetic qualities of the gaming environment thus specify, depict and convey visual representations to the learners. Characters, contexts, events or even objects within game based learning environments may serve as emotional anchors of learning depending on their aesthetic capacity (Kim & Kim, 2010). Each interaction in the game evokes different emotions from learners depending upon their sociocultural context. They seek solutions, which serve as artifacts or evidence of learning and the learners develop new identities to establish their learning. As noted earlier game based learning is often not used in classrooms for lack of proper pedagogies. However when the game designers establish themselves as model protagonists and experienced learners by revealing their own creative perceptions and sociocultural understandings through their game design, educators and researchers can better understand how games facilitate meaningful learning experiences and contribute to knowledge advancement. By sharing what motivated them to design the game they share their expertise in the subject or field through their creative design. Creativity is an integral part of instructional design, and aesthetic designs for learning environments and games need to be important aspect of the design process.

References

- Assassin's Creed*. Produced by Ubisoft (2007). Retrieved from <http://assassinscreed.ubi.com/en-gb/news/index.aspx>
- Aleven, V., Myers, E., Easterday, M., & Ogan, M. (2010). Toward a framework for the analysis and design of educational games. In *2010 IEEE International Conference on Digital Game and Intelligent Toy Enhanced Learning* (pp. 69-76) IEEE. Doi : 10.1109/DIGITEL.2010.55
- Barab, S.A., Sadler, T.D., Heiselt, C., Hickey, D., Zuicker, S. (2010). Erratum to: Relating narrative to inquiry and inscriptions: supporting consequential play. *Journal of Science and Education Technology*, 19, 387- 407. Doi : 10.1007/s10956-010-9220-0.
- Boden, M. (1998). Creativity and Artificial Intelligence. *Artificial Intelligence*. 103.347-356.
- Chen, C., Himsel, A., Dimitrieva, J., Dong, Q., & Xue, G. (2005). Effects of explicit instruction to “be creative” across domains and cultures. *Journal of Creative Behaviour*, 39(2) 89-110.
- Clinton, G & Hokanson, B. (2012). Creativity in the training and practice of instructional designers: the Design/Creativity Loops Model. *Educational Technology Research and Development*, 60, 111-130.
- Egenfeldt-Nielsen, S., Smith, J.H., Tosca, S.M. (2013). *Understanding video games : the essential introduction*. New York: Routledge.
- Gadamer, H.G. (2011). *Truth and Method*. New York: Continuum International Publishing Group.
- Gupta, D., & Kim, B. (2014). Connecting aesthetics and engagement in game based learning. In Babb, A. P. (Ed). *Proceedings of the IDEAS: Rising to the Challenge Conference*. Calgary, Canada: University of Calgary.
- Hokanson, B., & Miller, C. (2009). Role-Based Design: A contemporary framework for innovation and creativity in instructional design. *Educational Technology*, 49(2). 21-28.
- Jardine, D. W., (2006). On hermeneutics: “ Over and above our wanting and doing”. In K Tobin & J.L. Kincheloe (Eds.), *Doing Educational Research: A Handbook.*, (pp. 269-288). Rotterdam, Netherlands: Sense Publishers.
- Lavender, L. (2009). Facilitating the choreographic process. In J. Butterworth & L. Wildschut (Eds), *Contemporary Choreography*, (pp.71-89). London : Routledge
- Lavender, L., & Predock-Linnell, J. (2001). From improvisation to choreography : the critical bridge. *Research in Dance Education*. 2 (2). 195-209.
- Kim, B. & Kim, M.S. (2010). Distributed emotions in the design of learning technologies. *Educational Technology*, 14-19.
- Kirkland, K., Ulicsak, M., & Harlinton, M. (2010). Game based learning experiences : Testing the principles with teachers and students. Retrieved from: <http://www.futurelab.org.uk/projects/game-based-experience>
- Lycouris, S. (2009). Choreographic environments: new technologies and movement related artistic work. In J. Butterworth, & L. Wildschut (Eds), *Contemporary Choreography*, (pp.346-361). London : Routledge
- McKechnie, S. & Stevens, C.J. (2009). Visible thought: choreographic cognition in creating, performing, watching contemporary dance. In J. Butterworth, & L. Wildschut (Eds), *Contemporary Choreography*, (pp.38-51). London : Routledge.
- Nii-Yartey, F. (2009). Principles of African choreography : some perspectives from Ghana. In J. Butterworth, & L. Wildschut (Eds), *Contemporary Choreography*, (pp.254-268). London : Routledge
- On the Ground Reporter Darfur*, Produced by Butch & Sundance Media (2010). Retrieved from <http://www.gamesforchange.com>
- Pakes, A. (2009). Knowing through dance making : choreography, practical knowledge, and practice as research. In J. Butterworth & L. Wildschut (Eds). *Contemporary Choreography*. (pp.10-22). London : Routledge.
- Parrish, P. E. (2009). Aesthetics principles for instructional design. *Educational Technology Research and Development*, 57(4), 511-528.
- Shute, V.J., Rieber, L., & Van Eck, R. (2012). Games.... and ...Learning. In R. Reiser, & J Dempsey (Eds.), *Trends and Issues in Instructional Design Technology*. (pp. 321-362). New Jersey: Pearson Education Inc. Retrieved from http://myweb.fsu.edu/vshute/pdf/shute_pres_i.pdf.
- Smith-Autard, J. (2009). Creativity in dance education through use of interactive technology resources. In J. Butterworth, & L. Wildschut (Eds). *Contemporary Choreography*. (pp.90-105). London : Routledge
- Squire, K. (2011). *Video Games and Learning*. New York : Teachers College Press.
- Van Eck, R. (2006). Digital game based learning : Its not just the digital natives who are restless. *Educause Review*. 41(2). 16-30. Retrieved from <http://www.educause.edu/ero/article/digital-game-based-learning-its-not-just-digital-natives-who-are-restless>
- Wilson, B.G. (2005). Broadening our foundation for instructional design : four pillars of practice. *Educational Technology*. 45(2). 10-16.

Enhancing Motivation in Disaster Prevention Learning with Perceptual and Semantic Gaming

Koji TANAKA^{a*}, Tatsuto HIRAI^b, Mitsuru IKEDA^a & Masahiro HORI^b

^a*School of Knowledge Science, Japan Advanced Institute of Science and Technology, Japan*

^b*Graduate School of Informatics, Kansai University, Japan*

* kjtanaka@jaist.ac.jp

Abstract: Hazard maps provide knowledge about evacuation behavior, in addition to graphical indications of areas influenced by a disaster. However, without prerequisite knowledge or map reading literacy, it is not easy for citizens to fully understand hazard maps. Learning support systems for disaster education must thus to be effective in lightening the learning load and enhancing motivation for learning. If the content is not held in memory, learners would need to repeat the learning session, which would lessen their motivation for learning. Moreover, natural disasters do not happen often, and cannot always be predicted. Therefore, it is not easy to enhance citizens' motivation for disaster prevention learning. This can result in a vicious circle between degraded motivation and insufficient prerequisite knowledge. In this paper, we propose a learning support framework that helps gain learners' attention by gaming at two different processing levels and facilitates retention of disaster prevention knowledge on the basis of priming effect on implicit memory. The key idea behind this framework is to utilize two components: implicit learning by means of implicit memory and memory retention based on levels-of-processing effect, so that the vicious circle between degraded motivation and insufficient prerequisite knowledge can be disrupted.

Keywords: Disaster education, learning strategy, gaming, enhancing motivation

1. Introduction

In addition to graphical indication of areas affected by a disaster, hazard maps provide knowledge about evacuation behavior which enable decision making by concerned individuals. It is crucial for area residents to understand the significance and use of hazard maps distributed by local governments so that their self assistance ability can be improved. Without prerequisite knowledge or map reading literacy, however, it is not easy for many citizens to fully understand hazard maps. Therefore, the development of a learning support system which not only facilitates retention of the preliminary knowledge for hazard map comprehension but also enhances motivation for disaster prevention learning is essential.

Learning support systems for disaster education must be effective in lightening the learning load and enhancing motivation for learning. However, readiness for disaster prevention cannot be sustained unless previously learned content is firmly held in learners' memory, and the learners are motivated to repeat the learning process. If learned contents are not kept in memory, the learners have to review the learning sessions, which would reduce their intrinsic motivation for further learning. Moreover, as natural disasters do not happen often and cannot always be accurately predicted in advance, it is not easy to enhance residents' motivation for disaster prevention learning. This can result in a vicious circle between degraded motivation and insufficient prerequisite knowledge.

According to the ARCS model of motivation design (Keller, 1987), instructional environments need to be designed, so that learners' attention can be grabbed by stimulating their curiosity under unpredictable circumstances, and a sense of achievement can be formed by giving satisfaction. In this paper, we propose a learning support framework that attracts learner's attention by gaming and facilitates retention of disaster prevention knowledge by means of priming effect on implicit memory (Reber, 1989). This paper also reports the results of an empirical evaluation with a prototype system.

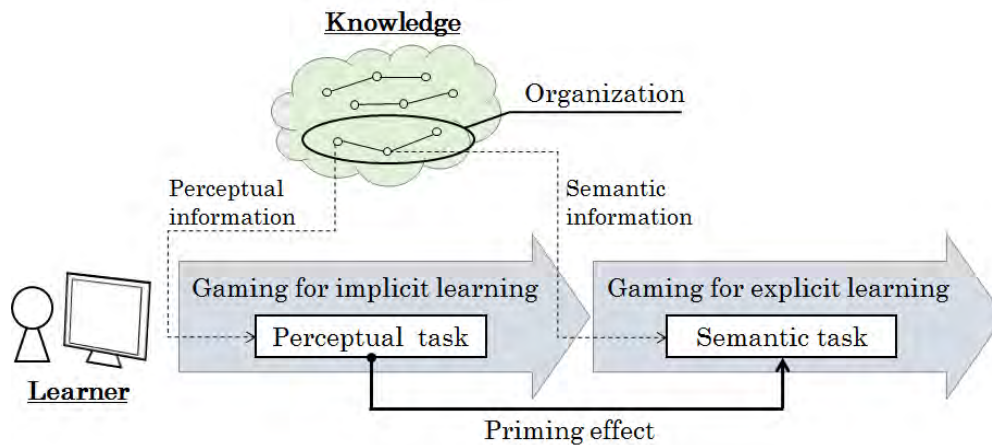

Figure 1. Overview of the proposed learning support framework.

2. Learning Support Framework

2.1 Cognitive Psychological Findings Applied for the Learning Support Framework

Memory without explicit consciousness of recall (implicit memory) is distinct from memory with consciousness of recall (explicit memory). A learning process that produces an effect on implicit memory is called implicit learning (Reber, 1989), and the effect brought about by implicit memory is known as *priming effect*. The priming effect is a kind of learning effect because memory tasks without conscious recall result in a positive effect on subsequent memory tasks (Terasawa, 1998). The positive effect can last for an extended period of time; for example, Komatsu (1984) demonstrated the priming effect was observed 5 weeks later when presented with a short stimulus of 3.5 second duration.

In human information processing, the depth of mental processing ranges from shallow to deep (e.g., structural, phonemic, and semantic). Deeper levels of processing achieve higher memory retention, which is called the levels-of-processing effect (Craik & Lockhart, 1972). Since more processing resources are required to accommodate the increase in process level or mental load, deeper level processing takes longer to complete (Craik & Tulving, 1975). The load at the semantic level is thus higher than that at the perceptual level. On the other hand, the cognitive load is quite small for shallow processes. However, repeating shallow processes can not lead to an improvement in memory retention even if the entire learning load is small throughout the course of the repetition (Craik & Lockhart, 1972). Memory retention based on the levels-of-processing effect and implicit learning have been adopted individually for previous learning strategies. In this study, we propose a learning support framework that utilizes these two components to break the above-mentioned vicious circle between degraded motivation and insufficient prerequisite knowledge.

2.2 Approach to Motivational Enhancement

Here we use the term “gaming” in the sense of simulation (Duke, 1974), which involves a representation or a model of reality in software. Players take the central role while in use, and that motivates players to learn readily from a particular scenario. In the area of disaster prevention learning, a card game called "Cross Road" (Yamori, 2012) was devised to attract learners’ interest and improve disaster imagination by challenging players’ judgment under time-varying uncertain situations. Most learning support systems make the learners aware of learning content in the original context of the simulation, and the learning contents are stored in the learner’s explicit memory. In our learning support framework, on the other hand, learning content is associated with constituents in a gaming context that is easier for learners to comprehend than in the context of the target field that is unfamiliar due to their lack of preliminary knowledge.

In our framework the learning process starts with gaming for implicit learning, where learning content is exposed merely as objects in the gaming scene without regard to the meaning of the context



(a) Perceptual game for shooting graphic symbols by touching the screen



(b) Semantic game for underpass as a role-playing game

Figure 2. Examples of perceptual and semantic gaming.

of disaster prevention knowledge; in the next stage, those objects are presented for explicit learning where all content is presented explicitly in the sense of a particular target field (Figure 1). According to this distinction of the presentation context, this framework facilitates retention of knowledge by associating preliminary knowledge or graphic symbols recognized during the perceptual task (e.g., bridge, underpass, and evacuation shelter in Figure 2(a)) with an entity in a target field appearing in the subsequent semantic task (e.g., underpass in Figure 2(b)).

3. A Prototype System for Flood Disaster Prevention Learning

Figure 3 shows a learning process based on our framework mentioned above, which includes a perceptual game for implicit learning and a semantic gaming for explicit learning. Each game is followed by a session for giving background knowledge. In the remainder of this section, the perceptual and semantic games are further explained.

3.1 Perceptual Game for Implicit Learning

In the prototype system, a shooting game targeting graphical symbols of map legends (Figure 2(a)) was used as a game for implicit learning with a perceptual task (hereinafter referred to as a perceptual game). In the perceptual game, five graphical symbols given in Table 1 (evacuation shelter, welfare evacuation shelter, gauging station, underpass, and bridge) were used as shooting targets. These targets are square, and their side length is one fourth of the screen height. These targets appear randomly from the left side and move linearly toward the right, and the moving time of a target from one side to another is about 2 seconds. With a maximum 12 targets appear on the screen at one time, and totally 32 targets appear during a gaming session in the prototype system.

The perceptual game, which consists of two sessions, is presented first to the learners (Figure 3(1)). The first session of the perceptual game exposes moving map legend symbols, and requests learners to touch as many of the symbols as possible. The number of touched symbols are counted and recorded as game's score. In the second session, additional rules are explained to the learners, namely, when symbols which stand for dangerous places (e.g., bridge and underpass) are touched, the number of such touched symbols is subtracted from the total score, while the number is added when symbols for safe places such as an evacuation shelter are touched. These additional constraints for gaming intend to encourage implicit understanding of the distinction between dangerous and safe places in the map legend. Note that the learning here is conducted implicitly because at this moment game users do not know that the map legend symbols are part of disaster evacuation knowledge. Since the perceptual game is a very simple shooting game, it allows the learner to concentrate more on touching graphical symbols. The key point here is that implicit learning during the perceptual game facilitates explicit learning by producing a priming effect later in the semantic gaming.

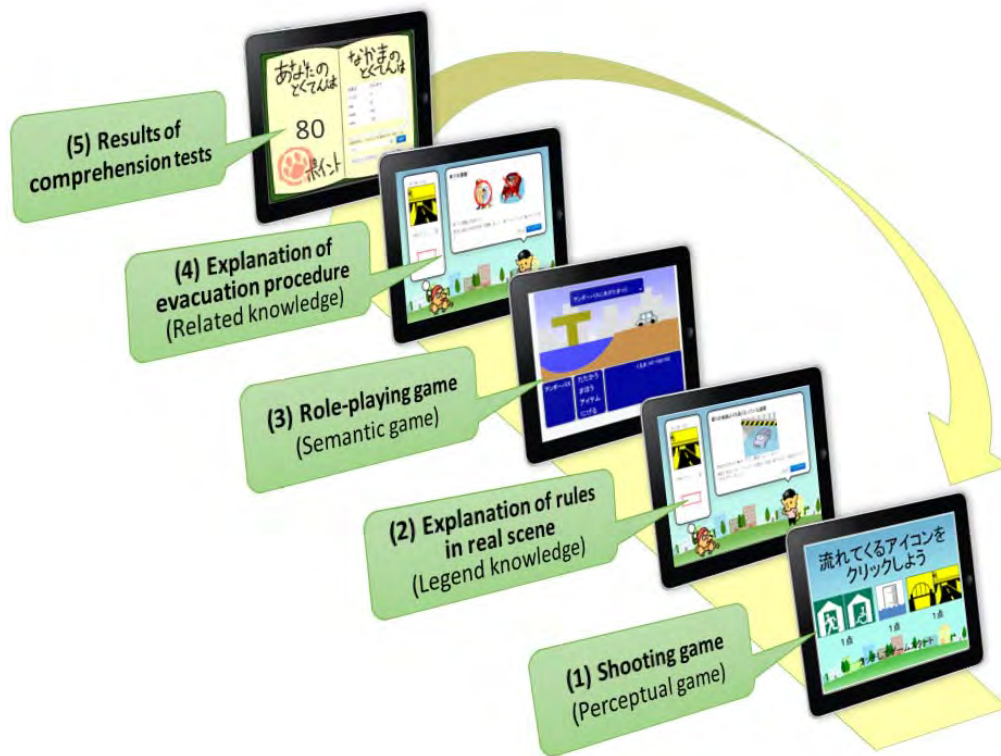

Figure 3. Learning process in the prototype system based on the proposed framework.

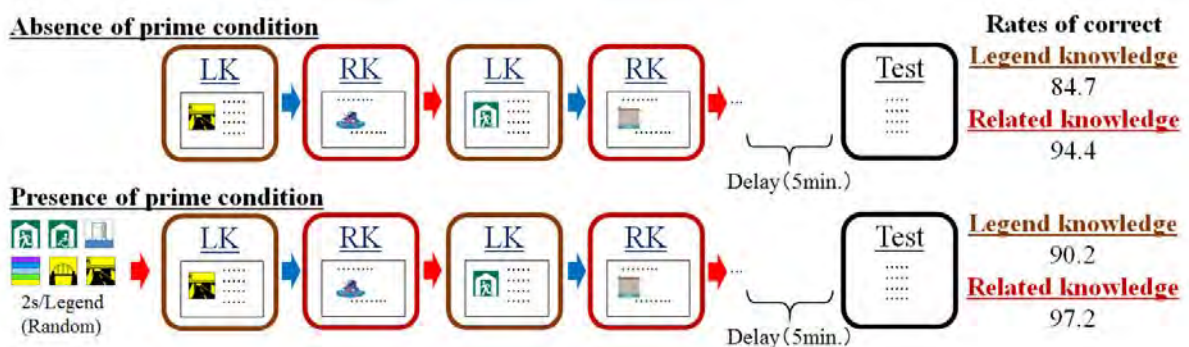







Figure 4. Results of the second experiment.

The learning effect of the proposed framework was tested in two web-based experiments with a total of 144 participants. In the first experiment (Hirai, Tanaka and Hori, 2013a), the rate of correct answers for the test of related knowledge differed significantly among presence (97.2) and absence (85.4) of prime conditions, $p < .05$, and the correct answer rate was higher in presence of prime condition. In the second experiment (Hirai, Tanaka and Hori, 2013b) depicted in Figure 4, the rates of correct answers for the tests of legend and related knowledge differed with marginal significance under presence or absence of prime conditions, $.05 < p < .10$. These results indicate that the rate of correct answers was higher in presence of prime conditions in both cases. The results of these experimental studies demonstrated the effect of memory retention of map legends and their related knowledge when perceptual-level information was presented before exposure to semantic information.

3.2 Semantic Game for Explicit Learning

As gaming for explicit learning in the semantic task phase (hereinafter referred to as semantic game), simulation games that mimics disaster situations were used. The semantic games required that the

Table 1. Map legend and its graphical symbol used in the perceptual game, and task descriptions of each semantic game that corresponds to a map legend.

Map legend and symbol used in the perceptual game	Task descriptions of each semantic game
Flood water depth 	Choose a building in which to shelter outside an area being flooded, before the time nearby rivers are flooded.
Gauging station 	Quickly choose a correct action based on emergency information presented at random.
Evacuation shelter 	Manipulate a graphic symbol of an evacuee and, by way of save road, navigate it to an evacuation shelter within the set time.
Welfare evacuation shelter 	Connect explanatory text to the illustration that most appropriately describes the scene of assisting vulnerable people.
Underpass 	Operate a graphic symbol of a car, and choose a command of battle action to fight with an anthropomorphic, flooded underpass (Figure 2(b)).
Bridge 	Operate a character of a little bonze, and choose a direction of movement to buy dumplings on a rainy day.

activity in the game correspond to the rules of the real disaster situation. The current prototype system provides with six semantic games featuring each of the six map legends in Table 1. When played with these semantic games, learners cannot make a higher score unless they understand the meaning of the map legends and their implications in disaster situation.

3.3 Gaming Simulation for Setting off Unsafe Behavior

It is not difficult for learners, for the most cases, to understand appropriate evacuation behavior as knowledge of disaster prevention. For example, it is straightforward to know why flooded underpasses should not be went through by cars. It is just because cars would be submerged and got stuck on the way. However, people sometimes fails to apply such knowledge to take an appropriate action, due to the so-called knowledge-to-action gap. Even if a learning support system simply presents a dangerous situation to learners, it does not necessarily mean the learners take unsafe actions spontaneously. For a better understanding of unsafe behavior in disaster prevention learning, simulation is useful since learners' behavior can be contextualized in a dangerous situation. Thus it is a crucial requirement for a learning support system to lead learners to take unsafe actions spontaneously.

In our learning support system, semantic games allow learners to take unsafe actions under the simulated or explicit context of semantic tasks. For example, a semantic game for underpass is realized as a role-playing game (Figure 2(b)). In essence, a semantic game can be regarded as a multiple choice test because the players finally select one of the actions available in the gaming contexts,. In the field of cognitive psychology, a phenomenon called the testing effect is known, which means that taking a memory test repeatedly produces substantially better retention than studying learning materials (Roediger & Karpicke, 2006). Taking account of the effect of this finding, semantic gaming is expected to contribute to enhancing memory retention because gaming facilitate for the learners to take tests or semantic games repeatedly.

4. Concluding Remarks

We set up a resident experience booth during an evacuation drill held in an area of Takatsuki City in Osaka Prefecture, Japan, on Nov. 9, 2013. About 100 local residents from children to the elderly participated in this drill. We provided a tablet terminal to participants at the venue so they could experience the prototype system. We then conducted an interview survey and a questionnaire survey. The proposed system gave local residents the opportunity to think about their behavior in disaster by directing their attention to the importance of flood hazard maps. It was confirmed from the experience that the disaster prevention information presented by the prototype system was understandable, and that residents were very interested in playing the prototype games. At the closing session of the disaster prevention drill, our activities were appreciated by the head of Takatsuki City Crisis Management Office as substantially contributing to increasing the awareness of disaster prevention for local residents. We are going to put this research to practical use and continue to develop application systems for disaster prevention education to be tested in schools and communities.

References

- Craik, F. I. M., & Lockhart, R. S. (1972). Level of processing: A framework for memory research. *Journal of Verbal Learning and Verbal Behavior*, 11, 671-684.
- Craik, F. I. M., & Tulving, E. (1975). Depth of processing and the retention of words in episodic memory. *Journal of Experimental Psychology: General*, 104 (3), 268-294.
- Duke, R. D. (1974). *Gaming: The Future's Language*. New York: Sage Publications.
- Hirai, T., Tanaka, K., & Hori, M. (2013a, March). Experimental study on a learning support method based on implicit memory and level-of-processing model. Paper presented at SIG on Advanced Learning Science and Technology, 67 (pp.53-58). Kochi, Japan. (in Japanese with English abstract)
- Hirai, T., Tanaka, K., & Hori, M. (2013b, September). Implicit effect of preceding perceptual processing by a learning support method based on level-of-processing model. *Proceedings of Human Interface Symposium 2013* (pp.643-647). Tokyo, Japan. (in Japanese with English abstract)
- Keller, J. M. (1987). Development and use of the ARCS model of motivational design. *Journal of Instructional Development*, 10(3), 2-10.
- Komatsu, S. & Ota, N. (1984). Priming effects in word-fragment completion for short- and long-term retention intervals. *Japanese Psychological Research*, 26 (4), 194-200.
- Roediger, H. L., III, & Karpicke, J. D. (2006). Test-enhanced learning: Taking memory tests improves long-term retention. *Psychological Science*, 17, 249-255.
- Terasawa, T. (1998). The basis of the micro-step estimation method or learning acquisition: Measuring unconscious learning level and systematizing learning contents. *Tsukuba Psychological Research*, 20, 91-98. (in Japanese with English abstract)
- Yamori, K. (2012). Using games in community disaster prevention exercises. *Group Decision and Negotiation*, 21(4), 571-583.

Game-based APP in Teaching Newton's Three Laws of Motion for High Schools Students

Hsin-Yih SHYU^{a*}, Yu-Hur CHOU^b

^a*Department of Educational Technology, Tamkang University, Taiwan*

^b*Department of Information Management, Tung Nan University, Taiwan*

*hyshyu@mail.tku.edu.tw

Abstract: This study aims to design and develop an interactive game-based learning APP for teaching Newton's three laws of motion for High Schools Students and examine students' attitudes towards Secondary Physics and this game-based learning materials. Subjects were 278 students in junior and senior high school. Results indicated that there was a significant difference between pretest and posttest and gender on attitudes toward learning physics ($p < .05$). In addition, the results from interviews with 6 high school teachers showed they were positive toward this software and its effects. Some suggestions for revisions were made from the students and teachers for further improvement.

Keywords: *game-based learning, APP, physics education, mobile learning, Newton's three laws of motion*

1. Introduction

Horizon Report (2012) has forecasted the most promising technologies likely to impact on K-12 education, such as: mobile devices & Apps, tablet computing, game-based learning, personal learning environments, augmented reality, natural user interfaces. Prensky (2001) pointed that the digital game based learning (DGBL) can solve the boring problem in the traditional classroom learning. He further claimed that students grow up along with the technology belonging to "game generation". Education for the game generation is different from that for previous generation. For example, digital games have been reported using in schools in many fields (Guillén-Nieto & Aleson-Carbonell, 2012; Kennedy-Clark, 2011; Oblinger, 2004; Staiano & Calvert, 2011; Young et al., 2012). Numerous studies also noted that the digital learning will increase students' motivation in learning and enhance their learning performance (Adachi & Willoughby, 2013; Kirriemuir & McFarlane, 2004; Hjert-Bernardi & Anderson, 2011). However, does gamed-based educational app still work in a physics course for a specific topic? This is the key question that we want to get the answer in this study. In this paper, we try to develop a game-based app for students according to the scenario-oriented strategies to learn Newton's Laws of motion. In the beginning, we raised the learning issues of physics courses. Then, we addressed our educational app design for learning the Newton's laws of motion which followed the digital game-based learning (DGBL). Finally, we tested and explained the effects on attitudes toward learning physics with the app.

1.1 State of problem. New technologies have a powerful influence on all aspects of our daily life. Many of them have an impact on the way we teach and learn. There are inconsiderable tendencies, including the reform of teaching models, the trend of information evolution, the convenience of making good use of mobile devices, grasping the advantages of applying technology in learning, and the teaching strategies of combination of challenging hands-on practice and contributing to autonomous learning. At the present time teaching physics in junior and senior high schools is quite challenging. The main problem is that students lack intention of learning in a traditional class; however, they are proficient with computers and interested in new things. It will be helpful to elevate students' intention if the learning environment is built with the technology of virtual reality for students (Parkinson & Hudson, 2002; Shyu & Chou, 2012). Moreover, the basics of physics are complicated and they need more mathematic logic computation. It takes a great amount of time for teachers to explain a phenomena in science ; therefore, students find it strenuous to learn physics. There is deficiency of time,

which troubles teachers while teaching. Students are not able to understand the aim and application of the basics, thus the experimental course will be needed to explain the basics of theories and the utilization of the application. If virtual reality technology is applied to construct 3D related game-based learning, it will be of benefit to students with low learning motivation.

Huang (2009) has pointed out that many physics students in college are familiar with the laws of physics; however, students' practical application of all kinds of basic physics often surprisingly disappoints professors. That may be due to junior and senior high school students' motivation for learning physics is merely for passing the entrance examination. By doing so, it diminishes students' interest in physics and cognition of utilization of physics. In addition, the work effectiveness of applications of simulation software needs verifying. All current simulation software has come into existence for a while and most of them adopted techniques such as Java and Flash. As a consequence, the screen is limited to a 2D range, and fails to display in 3D. There are limitations to show the applications of physics. Moreover, trends of mobile learning and education cloud contribute to mobilization, cross platforms and facilitation of teaching materials.

1.2 Purposes of Study The purpose of this study attempts to carry out an instructional design based on Newton's Three Laws of Motion. A cross-platform game-based material APP using 3D virtual reality technology is designed and produced. It is hoped that students can learn physics in a game-based virtual environment on cross-platform with a mobile device so that learning can be vivid and interesting, which elevates junior and senior high students' motivation for learning physics. Thus, it is hoped that the junior and senior high students receive an experimental instruction so as to acquire the understanding of how the product contributes to their physics learning and what attitude they have towards the physics game-based material. The aims of this paper are threefold: 1. to develop appropriate physics game-based APP -*The Newton Rabbit*: Newton's Three Laws of Motion; 2. to examine the feasibility of the product, e. g., to examine the change of students' attitude towards learning physics and the teachers' acceptability of the product and suggestions; 3. to explore the differences of the students of different genders after the students learning physics through physics games.

2. Game Design

2.1 Game Scenario *Newton Rabbit* is a scenario-based educational APP for learning Newton's three laws of motion. It starts with a story of a crowd of rabbits living on the moon. They have to apply Newton's laws in order to defeat the soldiers on earth, accomplish the tasks and then back home. In the end of the game, the result was shown to either fail or success, including the number of rabbits succeeded to return to the Moon. The software is intended to motivate high school students' interests and problem-solving abilities in learning science.

2.1 Game Features *Newton's Rabbit*, was mainly developed from the game-based learning design principles based on literature review. The game itself has an easy and intriguing plot with three stages. Students can increase their pleasant experience of learning through games. The complexity of learning physics, in traditional classroom, often makes students lose their motivation for learning it; therefore, the playability and challenges were taken into consideration while the game was designed. For example, (Shown in Stage One) players will face a challenge that they have to know how to launch the rabbit to the moon accurately. Accordingly, players explore and acquire the understanding of the theory of $F=MA$ and of application of the theory as well. After players get engaged in the game and gain a sense of achievement so as to enhance their motivation. In a traditional learning process, a teacher usually lectures along with numerous exercises. In the long run, students merely know how to calculate instead of acquiring knowledge. This app (*Newton's Rabbit*) emphasizes the discovery and exploration of the relationship between variables through interaction. Therefore, conflicts and choices were designed. For example, the *Newton Rabbit* in Stage Two, players need to choose to move the rabbit to face the bullets attacking and use the law of reaction to eliminate the bullets from the enemy. In this case, the back and forth design can help students understand and attempt to explain the importance of the reaction force in this stage. Players have the rabbits block the bullets and remove the enemy through the feedback loops. In addition, students are assisted in setting a goal to make the rabbit come back to the earth from the moon in the last stage (Stage Three) so as to gain rewards. This work embedded the knowledge

concepts in the game. Not only can students understand Newton's Three Laws of Motion by completing game stages, but the learning process can be elaborated in a competitive atmosphere in order to gain a satisfying evaluation and reach an educational goal via entertainment. This app (Newton's Rabbit) is a cross-platform game whose system supports computers, smartphones and tablets. We summary the features of this material as following:

1. The screen layout is so vivid that it can attract students' attention.
2. The characters-goofy looking rabbits are so cute that players cannot help but fall for them.
3. The way of playing a series of stage games makes students think and apply the knowledge of physics
4. The instructions, most of which can be carried out with a finger (on a mobile device) or with a mouse (on a computer), are easy and clear. Hence, students can get the hang of it rapidly.
5. The design with multi-versions enables students to play it at home or download it to a mobile device to enjoy it anytime anywhere.



Figure 1. Starting the Game



Figure 2. Stage one- Newton's Second Law of Motion

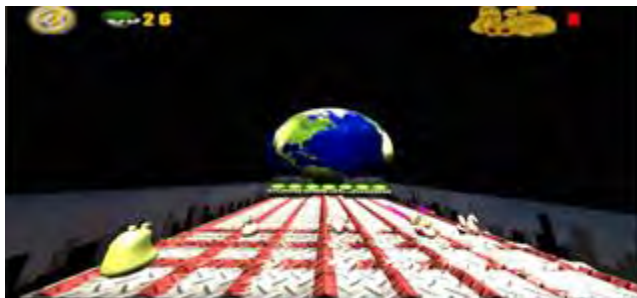

Figure 3. Stage two-Newton's Third Law of Motion



Figure 4: Stage two Newton's Third Law of Motion

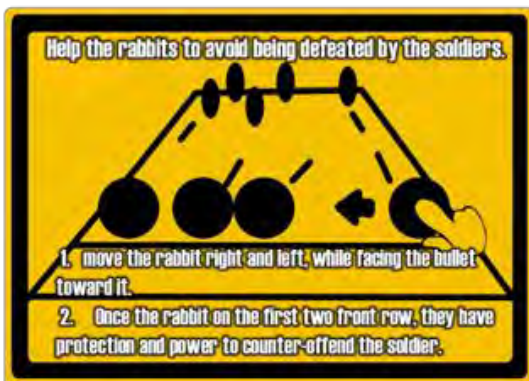

Figure 5. Instructions for Stage Two

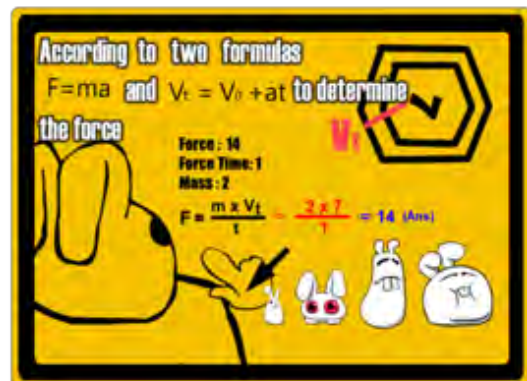

Figure 6. Instructions for State One

3. Research Design

The design-based research was applied to develop Newton Rabbit using ADDIE model. The App was developed by Unity 3D, 3DMaxTM, and PoserTM. Then, the questionnaires were administered before

and after the instruction. The participants in this experiment were 278 students from 8 high schools in Taiwan.

4. Results

4.1 Attitudes toward Learning Physics. Subjects were administered both before and after the treatment with the questionnaires of a pretest and posttest on attitudes towards learning physics. The pretest was 3.11, and the posttest was 3.93, indicating most of students had a positive attitudes toward physics. The results of a correlated t-test revealed that students' attitudes toward learning physics significantly improved after learning with Newton Rabbit ($p < .05$).

Table 2 : Pretest and Posttest on Attitudes toward Learning Physics

		Mean	Std. Dev.	Prob.
Attitudes toward learning	Pretest	3.11		
Physics	Posttest	3.93	0.91	0.00**

** $p < .001$

A further investigation was found that most students liked Newton Rabbits because it was interesting, can enhance motivation, and enjoy the way of this learning. Students also expressed Newton Rabbit can help them learn physics and would like to try more Apps like Newton Rabbit.

Table 3 Posttest on Attitudes

Items	Mean	Std. Dev.
「Newton's Rabbit」 make learning physics more interesting	4.04	.95
「Newton's Rabbit」 enhance my learning motivation	3.93	.98
「Newton's Rabbit」 help me less afraid of learning physics	3.80	1.02
I am willing to spend more time on learning physics with 「Newton's Rabbit」.	3.72	1.06
「Newton's Rabbit」 help me understand the principle of Newton's laws.	3.86	.93
I enjoy the way of learning physics with 「Newton's Rabbit」	4.05	.97
I would like to try more activities of Apps in learning physics like 「Newton's Rabbit」.	4.04	.92
Over all, 「Newton's Rabbit」 helps me learn physics in a better way.	3.96	.95
Average	3.92	.97

4.2 Gender Differences in Attitudes toward Learning Physics with APP. The results of a t-test between gender indicated there was a significant difference ($p < .05$). The girls felt more positive toward learning physics with APP than the boys.

Table: Gender difference on Attitudes

	gender	Mean	Std. Dev.	Prob.	Mean
Gender	Male	3.87	.926		0.002**
	Female	4.02	.709		

** $P < .001$

5 Conclusions and Suggestions

This study attempted to awaken teachers' attentions to the effects of a game-based APP in assisting middle school students to learn physics-Newton's Three Laws of Motion. The results, which were based on empirical evidences and interviews with teachers and students, have been shown very positive. It is explained that the scenario-and- game-based APP has helped students learn physics and promote physics education in middle schools. Moreover, boys are usually more familiar with game-based software than girls, and they have an advantage of the (positive) learning attitude over girls. This study

indicated that this kind of game-base APP for learning physics is popular with girls, and girls' positive attitude is better than boys'. As a consequence, the results of the study have suggested that the future of game-based software is promising. Meanwhile, Taiwan's government has been promoting the educational apps market to K-12 schools. The results of the present study yielded from the experience of research and students' feedbacks on the APP can offer an example of the development of design and application to educational technology industry, including game-based learning software, application of school education, and textbook publishers, and instructional material designers. It is hoped that the game-based learning APP can be applied on a large scale.

References

- Carr, D. & Bossomaier, T. (2011). Relativity in a rock field: a study of physics learning with a computer game. *Australasian Journal of Educational Technology*, 27, 6, 1042–1067.
- Guillén-Nieto, V. & Aleson-Carbonell, M. (2012). Serious games and learning effectiveness: the case of It's a Deal! *Computers&Education*, 58, 1, 435–448.
- Giannakos, M. N. (2013). Enjoy and learn with educational games: examining factors affecting learning performance. *Computers & Education*, 68, 429–439.
- Kennedy-Clark, S. (2011). Pre-service teachers' perspectives on using scenario-based virtual worlds in science education. *Computers & Education*, 57, 4, 2224–2235.
- Kirriemuir, J. & McFarlane, A. (2004). Literature review in games and learning. Retrieved November 4, 2012, from <http://telearn.archives-ouvertes.fr/docs/00/19/04/53/PDF/kirriemuir-j-2004-r8.pdf>
- Oblinger, D. G. (2004). The next generation of educational engagement. *Journal of Interactive Media in Education*, Special Issue on the Educational SemanticWeb, 8, 1–18.
- Parkinson, B., & Hudson, P. (2002). Extending the Learning Experience Using the Web and a Knowledge-based Virtual Environment, *Computers & Education*, vol. 38, 2002, pp. 95–102.
- Shyu, H. & Chou, Y. (2012). Investigation of the Effects on 3D Digital Game-Based Learning in Teaching Kinematics for High Schools Students. Paper presented to 2012 International Conference on Digital Game-Based Learning. Hongzhou, China.
- Young, M., Slota, S., Cutter, A., Jalette, G., Mullin, G., Lai, B., Simeoni, A., Tra, M. & Yukhymenko, M. (2012). Our Princess is in another castle: A review of trends in serious gaming for education. *Review of Educational Research*, 1-29.

Gamification in Academia Practice – What Motivate Users Most

Ming-Shiou KUO^{a*}, Tsung-Yen CHUANG^a, Ting-Chieh CHUANG^a, Po-Yu CHEN^a & Hsin-Chih LIN^a

^a*Department of Information and Learning Technology, National University of Tainan, Taiwan*

*ccmitchellkuo@gmail.com

Abstract: Gamification is the use of game design elements and game mechanisms in non-game context to increase audience's motivation and engagement. Not only being applied on the commercial market to attract consumers, gamification is also used in educational context by teachers to help keeping students engaged and motivated in the physical classrooms. This paper furthermore upraises the discussion of how the gamification strategies can be implemented online for a website with academic purposes to retain its members, and what of which are the members' most concerns a designer should adapt to if time and resource are limited. Examples are given and an online survey of 73 subjects with empirical experience was conducted to reveal that among those game mechanisms proposed, the graphical feedbacks are the subjects' most concerns, followed by the gamified theme activity and discussion board. For websites which are not gameplay purposed this paper could provide useful suggestions for the designers who try to use gamification for enhancing the audience's participation and enthusiasm, even for educational purposes.

Keywords: Gamification, Game mechanisms, Game elements, Motivation, Engagement

1. Introduction

Gamification, an emerged trend of using game mechanisms or elements in non-game context for increasing audience's motivation and engagement, needs more designers' efforts to arrange and carefully implement for integrating with the non-game target than just design a pure game. It is more likely that game designers try from the beginning to pack a non-game target by using game design strategies for the insipid and unattractive content or context concerned by the audience. The concept is based on that the game elements in entertaining video games should be able to make other, non-game applications more enjoyable and engaging as well (Flatla, Gutwin, Nacke, Bateman, & Mandryk, 2011). However, the definition of game elements and how to use it for gamification brings up debates among researchers and will be discussed in the later literature review section.

Non-game content or context covers many domains including commercial market and education, therefore the purpose of applying gamification could be at least divided into two different perspectives: organization benefit and meaningfulness for students or the target audience. Nicholson (2012) argues that the long-term benefits to the company eventually result from the positive and meaningful benefits for the user, therefore a user-centered theoretical framework was proposed, in theory and in ideal condition. However, for short lifetime products or for promotion in the competitive market, a gamification designer is inevitably bound with limited time, budget and the needs of the organization, therefore our study tries to identify what mechanisms are most concerned or welcomed by the target audience to save the designers.

Another setting of this study is putting the gamification online. Take gamification in education for example, in most real cases gamification is implemented in just the physical classroom for teaching. In which context a teacher can easily arrange or modify the gamification strategy in a controllable environment for gathered students, however to digitize the gamification strategy or mechanisms online is a different thing, and usually ignored in many gamification 101 guidelines for education (Fioriello, 2013; Lepi, 2013). The survey samples of this study were then collected online from those who have the experience of visiting membership websites with gamification applied digitally. The membership sites may be an educational platform with personnel account setting, or a commercial site with lucky draw

games, or a forum with different discussion boards. One thing in common among those sites is their goals of retaining and increasing the members' engagements and motivations for visiting. We hope that through this survey and discussion, valuable efficiency gamification design data could be provided for future related research.

2. Literature reviews

Gamification uses game-thinking and playful design in non-game context as a motivational tool to engage people (de-Marcos, Domínguez, Saenz-de-Navarrete, & Pagés, 2014). Ryan and Deci (2000) distinguished motivation into two types, the intrinsic and extrinsic motivation in their early Self-Determination Theory (SDT). Based on the reasons or goals that give rise to an action, the intrinsic motivation refers to people doing something because it is inherently interesting or enjoyable, while the extrinsic motivation refer to doing something because it leads to a separable outcome, e.g., rewards, punishments or pressures. In the classic literature extrinsic motivation has typically been characterized as a low quality form that contrasts with intrinsic motivation, yet in Ryan and Deci's taxonomy the extrinsic motivation still plays an important role and has the great opportunity to internalize and integrate with the external regulation therefore results in an orientation shift, Deci furthermore discussed the effects of all rewards and did explicit analyzing to clear that the understanding of intrinsic motivation by tangible rewards is indeed a significance issue (Deci, Koestner, & Ryan, 2001).

Wang and Sun (2011) further linked the usage of reward system as the extrinsic motivation for video game experience. They discussed how game reward systems can be used to motivate or change behaviors in the physical world, as well as how reward mechanisms foster intrinsic motivation while giving extrinsic rewards. Eight virtual reward forms in digital game worlds were proposed including score system, point system like experience point, item granting system, virtual resources like wood and stone for building facilities in certain games, achievement system, feedback messages as instant reward, plot animation and pictures like cutscenes and badges, and unlocking mechanism for accessing new game content. These reward forms give clues for our later gamification design on how to provide positive player experiences, establish status, attract attention, and help players building social connections with others.

For the nature of gameplays the inherent fun, interesting and enjoyment of games can be typically linked to the intrinsic motivation and considered as a high quality form, therefore many discussions of game-based learning, game-based training, or serious games which use an off-the-shelf game as a medium or as a game-based motivational tool to engage the target audience are emerging in recent years. However if there is no existing game for increasing people's motivation of doing something that is inherently without fun and enjoyment, the alternative approach which uses the advantage of game's motivation linkage to repack the insipid task with a game form, in other words, to gamify a non-game activity for increasing people's engagement, is gamification promisingly.

Since a non-game context is different from games from the bottom, it is hard to just find and extract a fine game's subtle core spirit to replace the non-game's heart. That is why most gamification theorists turn to discuss the game design elements, game mechanisms and strategies to try building the guidelines for gamifying the targets. Brathwaite and Schreiber (2009) use the term game design atoms to introduce the elements of games, including the game states, a collection of all relevant virtual information that may change during play; players, avatars and game bits - the art assets such as icons, sprites, objects, NPCs or monsters; the game mechanics which are rules acting upon the above to change the game state and are the ingredients of game design, not to mention the game dynamics, goals and theme.

Reeves and Read (2009) argues that some so called game elements like avatars, ranks, levels, time pressure, competition rules and some other ingredients can also be found outside of games or are not necessarily in different game genres, therefore would not be readily identified as 'gameful', let alone game specific. In addition, how game elements are perceived can be a very subjective judgment depending on different perspectives of designers or players.

Since what game elements are is still need to be discussed, Deterding, Dixon, Khaled, and Nacke (2011) restrict gamification to the description of elements that are characteristic to games, and reserve the term for the use of gamifying design. Although the definition may bring up another debate

for what is “characteristic” of games, their proposed levels of game design elements give the practitioner a direction to design gamification, show as table 1 below.

Table 1: Levels of Game Design Elements (Deterding et al., 2011)

Level	Description	Example
Game interface Design patterns	Common, successful interaction design components and design solutions for a known problem in a context, including prototypical implementations	Badge, leaderboard, level
Game design patterns and mechanics	Commonly reoccurring parts of the design of a game that concern gameplay	Time constraint, limited resources, turns
Game design principles and heuristics	Evaluative guidelines to approach a design problem or analyze a given design solution	Enduring play, clear goals, variety of game styles
Game models	Conceptual models of the components of games or game experience	MDA; challenge, fantasy, curiosity; game design atoms; CEGE
Game design methods	Game design-specific practices and processes	Playtesting, playcentric design, value conscious game design

As can be seen in table 1, game interface design patterns with implemented solutions such as badge and leaderboard, are distinguished from game design patterns or game mechanics which can be implemented with many different interface elements, therefore are more abstract and treated as distinct.

Besides those models and theories proposed in the academic research, from commercial market a gamification agency Bunchball.com publishes its white paper to link human desires as game dynamics with game mechanics, such as points, levels, challenges, leaderboards, gifting and charity. Table 2 from Bunchball.com gives a clear picture of how each game mechanic interacts with human desires, respectively. The black dots signify the primary desire a particular game mechanic fulfills, and the white dots show the other areas that it affects.

Table 2: The interaction of basic human desires and game play, adapted from Bunchball.com (2010)

Game Mechanics	Human Desires					
	Reward	Status	Achievement	Self Expression	Competition	Altruism
Points	●	○	○		○	○
Levels		●	○		○	
Challenges	○	○	●	○	○	○
Virtual Goods	○	○	○	●	○	
Leaderboards		○	○		●	○
Gifting and Charity		○	○		○	●

The implemented solutions above for gamification are now often seen in many websites with membership registration to record each member’s performance or engagement by accumulated points, level, leaderboard and other game interface design mechanisms such as badges and trophies (de-Marcos et al., 2014; Domínguez et al., 2013). Although using virtual pictorial reward is considered as task-contingent, performance-contingent or completion-contingent rewards which is categorized into extrinsic rewards (Deci et al., 2001) and will decrease intrinsic motivation, many commercial operations still use extrinsic rewards including tangible, material ones, e.g., money and prizes, to attract potential customers. From instructional aspect the decreasing of intrinsic motivation may result in students’ low learning performance, however in commercial marketing perspectives, it is worthy to use

extrinsic rewards like lottery or draw lots to promote the sales of a short-lifetime product, therefore we regularly argue that a full understanding of the gamification purposes in different context with additional factors and considerations is necessary.

To sum up, games are typically considered to provide joyful intrinsic motivation, and gamification tries to parse that characteristic of games for applying on the non-game applications. Because people may lack intrinsic motivation for non-game applications, extrinsic motivation such as rewards or other regulations may be necessary for the gamifying process to engage people. In the above reviews many game design mechanisms are discussed, yet from the gamification experienced users' perspective, which mechanism brings up the most motivation or is not essential, is still need to be explored for efficient gamification design.

3. Methods and implementation

An online survey was used to investigate the expectations of subjects regarding the usage of the game interface design elements in their favorite membership websites. To assure that all subjects at least have experienced one membership website with gamification mechanisms, the survey is deployed on our multi-purposes platform, LOPUPA (<http://lopupa.npust.edu.tw>), "learning on projects of united promotion for academia." The ultimate goal of the platform design is to gamify the process of academic activities in the National Pingtung University of Science and Technology, NPUST. Faculties can use the platform to introduce or promote their projects or research outcomes, students can demonstrate their projects for feedbacks, other members can interact with the non-game educational context and become research samples, industries can contact the faculties, students and members for cooperation opportunities or marketing purposes.

Game design mechanisms are implemented in the platform including points, leaderboards, challenges and rewards, etc. Table 3 describes the design of point mechanism in LOPUPA, three types of point are introduced, and the tangible rewards system is shown in fig. 1.

Table 3: The point mechanism in LOPUPA

Point type	Obtain methods	Purpose
Experience Point	Personnel engagement with LOPUPA: Logins, participating online single player activities, responding online surveys.	Quantitate the interactions between user and the system
Charisma Point	Social engagement in LOPUPA: Using discussion boards, participating online multi-user activities to interact with other users.	Quantitate the interactions among users.
Gift Point	converted by activity rules: $X*(EP) + Y*(CP) - GP$ spent for gifts = GP X, Y depends on each activity design.	Virtual currency to convert user performance for exchanging real incentive gifts as tangible rewards.



Figure 1. The reward system for gift point exchange

The thematic activities and web games are also provided to introduce and engage people in NPUST content made by its faculties and students, fig. 2 shows the portal. As described in table 2, these challenging arrangements may fulfill the human desires for competition, achievement and more, including self-expression as one of the LOPUPA members shows his/her complete collection of collectable cards in the Hakka activity discussion board as in fig. 3.



Figure 2. The thematic activity and thematic web game module

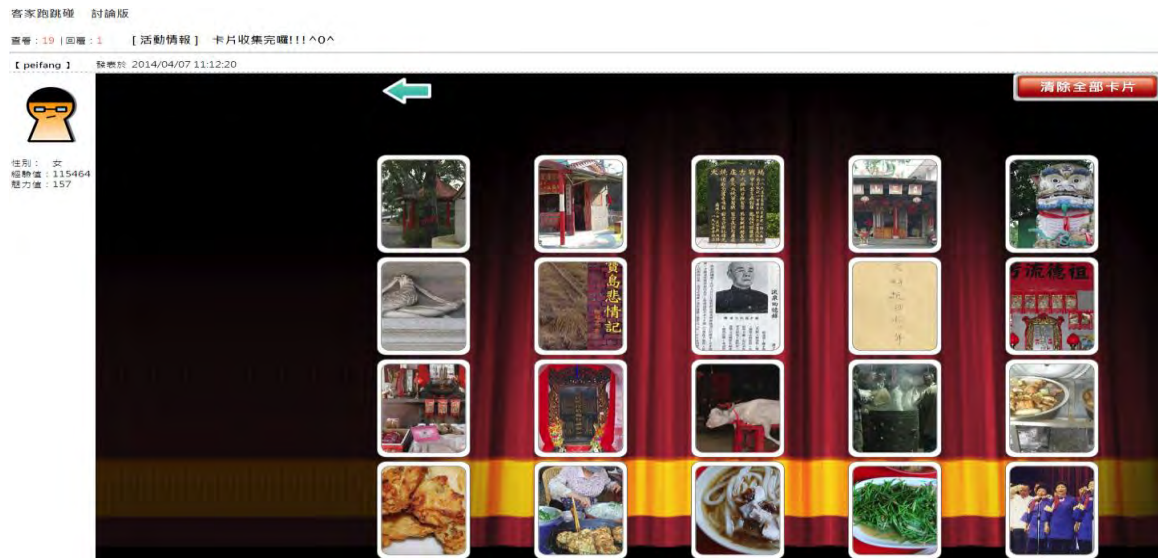

Figure 3. The LOPUPA member who first completed collecting all collectable cards in an activity posted his/her achievement in the discussion board

With the deployment and implementation above, our survey subjects are registered members who are exposed to the gamification platform and aware of the mechanisms, therefore their answers and suggestions could reflect the authentic responses for improving gamification strategies in the future.

4. Results and Conclusion

A Likert-type seven-point scale with options ranged from 1 (very disagreeable) to 7 (very agreeable) is deployed, and 73 members responded. The result of the questionnaire showed the top three mean values fall into: Graphical incentives is a must have to make my determination more strong for completing the online theme activity or web games ($M = 5.59, SD = 1.41$); Online theme activity or thematic web games of a membership website can keep my interest and retain my visits ($M = 5.55, SD = 1.41$); and Discussion board is a must have to open my communication with other members or web administrators to keep my enthusiasm ($M = 5.55, SD = 1.41$).

The survey reveals that graphical virtual feedbacks such as trophies, badges or collectable cards, the theme activities or web games and the discussion board are the top three welcomed

gamification methods. These findings could be explained as follows accordingly: members like to have their online self-fulfillment displayed in graphics, members' retention are mainly because they have interests in the theme activities regarding the website property, and members like to have community interactions by social tools which has been proofed in de-Marco's gamification and social networking study. On the contrast, the leaderboard has the lowest score comparatively, suggesting that displaying accomplishments for competition with others is not so important from the members' perspectives.

Although the tangible rewards are not attractive enough to make it on the top of the list in our study, in the open question section of the survey, some members do respond with the expectations of gift varieties, lower point thresholds for gift exchanging, and having a lottery instead of accumulating gift points by continuously participating the theme activities or web games. However we must consider the balance between the members' wishes and the organization's gamification purposes and resource, making the strategy of proper balancing issue our future considerations, including the frequency of developing new theme activities or thematic web games.

This article reports the empirical investigation of gamification for educational promotion context. Unlike small classroom surveys in other similar gamification researches, a gamified platform LOPUPA was established with faculties, students, visitors and industries involved, and an online survey was conducted to understand which mechanisms are the most important for members' retention and engagement through the internet. Our future work will include the further analysis of how users interact with the strategy from the play theory's point of view, and the implementation of Google Analytics to retrieve the global view of user behaviors. The digital gamification services or web designers therefore could be benefited by our research outcomes.

References

- Brathwaite, B., & Schreiber, I. (2009). Challenges for Game Designers Retrieved from http://www.docunator.com/bigdata/1/1366451007_8b52b39dce/challenges-for-game-designers.pdf
- Bunchball.com. (2010). Gamification 101: An Introduction to the Use of Game Dynamics to Influence Behavior [White Paper]. Retrieved March 11, 2014, from <http://www.bunchball.com/sites/default/files/downloads/gamification101.pdf>
- de-Marcos, L., Domínguez, A., Saenz-de-Navarrete, J., & Pagés, C. (2014). An empirical study comparing gamification and social networking on e-learning. *Computers & Education*, 75(0), 82-91. doi: <http://dx.doi.org/10.1016/j.compedu.2014.01.012>
- Deci, E. L., Koestner, R., & Ryan, R. M. (2001). Extrinsic rewards and intrinsic motivation in education: Reconsidered once again. *Review of Educational Research*, 71(1), 1-27.
- Deterding, S., Dixon, D., Khaled, R., & Nacke, L. (2011). From game design elements to gamefulness: defining "gamification". Paper presented at the Proceedings of the 15th International Academic MindTrek Conference: Envisioning Future Media Environments, Tampere, Finland.
- Domínguez, A., Saenz-de-Navarrete, J., de-Marcos, L., Fernández-Sanz, L., Pagés, C., & Martínez-Herráiz, J.-J. (2013). Gamifying learning experiences: Practical implications and outcomes. *Computers & Education*, 63, 380-392. doi: 10.1016/j.compedu.2012.12.020
- Fioriello, P. (2013). 25 Things Teachers Should Know About Gamification. Retrieved February 21, 2014, from <http://www.edudemic.com/25-things-teachers-should-know-about-gamification/>
- Flatla, D. R., Gutwin, C., Nacke, L. E., Bateman, S., & Mandryk, R. L. (2011). Calibration games: making calibration tasks enjoyable by adding motivating game elements. Paper presented at the Proceedings of the 24th annual ACM symposium on User interface software and technology, Santa Barbara, California, USA.
- Wang, H., & S, C.-T. (2011). Game reward systems: Gaming experiences and social meanings. Paper presented at the Think Design Play: The fifth international conference of the Digital Research Association (DIGRA).
- Lepi, K. (2013). How to Gamify Your Classroom in 6 Easy Steps. Retrieved February 21, 2014, from <http://www.edudemic.com/gamify-your-classroom/>
- Nicholson, S. (2012). A User-Centered Theoretical Framework for Meaningful Gamification. Retrieved Dec 10, 2013, from <http://scottnicholson.com/pubs/meaningfulframework.pdf>
- Reeves, B., & Read, J. L. (2009). *Total Engagement: Using Games and Virtual Worlds to Change the Way People Work and Businesses Compete*. Boston, MA: Harvard Business School Press.
- Ryan, R. M., & Deci, E. L. (2000). Intrinsic and Extrinsic Motivations: Classic Definitions and New Directions. *Contemporary Educational Psychology*, 25(1), 54-67. doi: <http://dx.doi.org/10.1006/ceps.1999.1020>

Enhancing Children's Numeracy & Te Reo Skills using Computer Games

Kalpana NAND^a, Nilufar BAGHAEI^{b*}, John CASEY^b

^aMission Heights Primary School, 103 Jeffs Road, Flat Bush, Manukau 2016, New Zealand

^bUnitec Institute of Technology, Private Bag 92025, Victoria Street West, Auckland 1142, New Zealand

*nbaghaei@unitec.ac.nz

Abstract: The use of computer games as common vehicles for education, as opposed to pure entertainment, has gained immense popularity in recent years. In our earlier work, we investigated the appealing characteristics of engaging computer games for children and designed an educational tool based on those characteristics. In this paper, we present the results of a study conducted with 120 primary school children, in which two versions of our proposed educational tool (features enriched vs feature devoid) were used for four weeks to teach primary school curriculum areas of Numeracy and Te Reo Maori language. The effectiveness of the educational tool was measured using a pre-test and a post-test, as well as other indicators such as subjective analysis, the frequency and duration of time on playing the game. We found that the features enriched game enhanced children's learning in both Numeracy and Te Reo curriculum areas more than the feature devoid version. In the case of Numeracy, the increase in scores was twice as much as the feature devoid version and in the case of Te Reo it was five times as much. Finally, the results of the subjective analysis showed that the feature enriched game was more popular with children – the test group indicated that they enjoyed playing the game more than the participants in the control group and are more likely to recommend it to their friends. The results also showed that the sound effects, the visual effects, the level of challenges in the game and the feedback messages contributed more to their engagement.

Keywords: Learning, games, literacy, numeracy, engagement, children

1. Introduction

The success rate of computer games in engaging children has prompted educational researchers to investigate if similar techniques can be used to engage children with learning. Studies carried out by Fisch (2005) and Chen et al (2011) are two out of the many such studies which have focused on how to achieve positive results for learning by playing games. A key factor which has generated a lot of interest is the capacity of such games to engage the players for extended periods of time. There are certain attributes of computer games which contribute to how well they are received by the players. Designers of educational tools can integrate these attributes to maximise the tool's effectiveness in increasing learning outcomes, level of engagement and motivation. According to Prensky (2001), a prerequisite of successful learning is motivation. He argues that a lot of what is in the curriculum is not motivating for students these days. Yet the same children are motivated and excited to play video games for long duration. What is notable is that some children's attitude towards video games is the opposite of the attitude they have towards learning in schools. One way of getting children motivated is to design educational tools with the aim of making them as engaging and motivating as popular commercial games. These tools can be integrated with the curriculum to enhance children's learning.

In our earlier work, we investigated the main characteristics of engaging computer games (i.e. graphics, feedback and challenge) and designed an educational tool with those characteristics embedded into it (Nand et al, 2013). This paper seeks to examine the effectiveness of our proposed educational tool in enhancing students' knowledge of Numeracy and Maori Language – two subjects heavily used in New Zealand primary school curriculum

The remainder of this paper is organised as follows. Section 2 reports on the current literature. Section 3 briefly describes our proposed educational tool. We then present the research questions, evaluation study and the results in Section 4, followed by conclusions and future work.

2. Related Work

The use of technology, such as computer games, to enhance student achievement in the classroom is a timely topic that permeates a lot of educational literature today. Video and computer game design have been studied by various researchers interested in finding out how different aspects of the game design could be utilised in developing educational games (e.g. Malone, 1981; Dondlinger, 2007; Pinelle et al 2008). The increase in the popularity of games and recent developments in information and computer technologies have attracted researchers to investigate the learning benefits of computer games.

There have been a number of studies showing that children's learning increased as a result of playing computer games. Research (e.g., Csikszentmihalyi, 1990; Rogoff, 1990) has shown that game playing makes up a vital element of a child's cognitive and social development. These studies assert that children learn more from playing and carrying out "hands-on" activities than by being simply asked to "recite" information from books. According to Vygotsky (1976), children learn by playing with others, creating and improving their zone of proximal developments. Fisch (2005) has noted that children have learnt about diverse subjects such as prehistory and asthma education by playing computer games. The learning aspect of computer games has been further endorsed by Chen et al (2011). In this study, the researchers proposed a set of design guidelines that can be ideally applied to any game to teach children how to manage their diabetes. The preliminary results of their research showed that users enjoyed playing the game and they believed their knowledge of diabetes increased as a result of playing the game. Other examples of educational and health-related games include Consolvo et al., 2006; Fujiki et al., 2008; Alankus et al., 2010.

Based on our experience, most of the educational games available in New Zealand primary schools are not motivating enough for students. These games lack the fun factor. Children are not as motivated to play these games as they are to play popular computer and video games at home. Most of the games that do exist are usually the basic grill and drill practice models. There is a need to develop useful and instructional computer games, which are relevant to the current New Zealand curriculum and can be integrated in the day to day learning. In our previous study, we investigated the main characteristics of computer games used to engage player for a long period of time. We then designed an educational tool based on the feedback we collected.

3. Game Design

We selected a group of 120 children aged between 9-10 at Glen Eden Primary School in Auckland, NZ. They were given a questionnaire and were asked to choose 3 features (from a given list) of computer games that they found most appealing. The following game attributes were most appealing (Nand et al., 2013):

- Challenges (CH): having different levels in the game
- Feedback (FB): knowing how many points were scored
- Graphics (GH): having realistic graphics

The participants were also asked to select the curriculum area in which they preferred a game to be designed in. The Topics Related part included Science, Social Studies, Technology and Te Reo (Māori language). A vast number of children were interested in playing numeracy games. Some of the reasons given as to why they wanted a numeracy game developed included: "*I want to get better at maths*", "*I want to learn my multiplication facts*", "*Learning maths in a game will be a fun way to learn*" and "*I don't like maths so playing a game and learning will be better*".

Driven by the three main characteristics identified by the target group and described in the previous section (i.e CH, FB and GH), a variety of open source games were examined. We felt that the Java-based open source game "Who wants to be an Millionaire" (<http://quizshow.sourceforge.net/download.html>) is a suitable option to choose for the preliminary evaluation (see Fig. 1). It was also identified as one of the games children enjoyed playing; hence modifications were made to incorporate educational features into it.

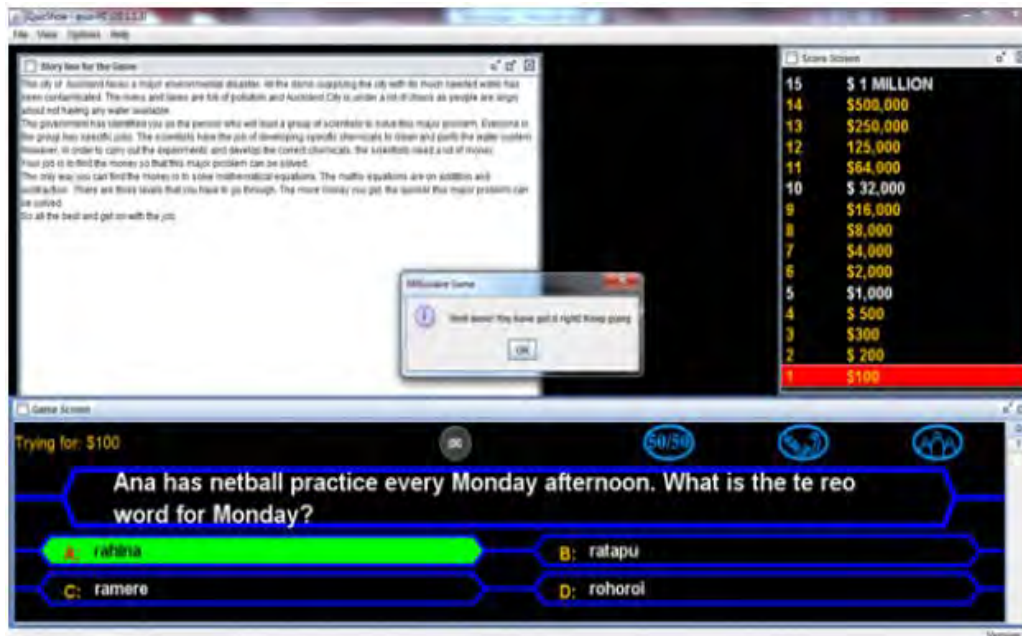

Figure 1. Screenshots from the game “who wants to be a millionaire?”

The game is based on a television game show in which the participants are offered cash prizes for correctly answering a series of multiple-choice questions in the order of increasing difficulty levels. This game can be configured easily to include any content. New content can be added by including the questions at various levels as a text file. Choosing an incorrect answer at any point in the game ends the current session, with a feedback message saying the game can be played again from the beginning. Depending on when the incorrect answer is given, the player can leave with either no money or certain amount. The amount a player can leave with depends on the level reached. The game designed for this study had three levels indicated by an amount written in white font compared to the rest of the amounts which are written in yellow font (see Fig. 1). Once a player passes a level1 indicated by the amounts \$1,000, \$32,000 and \$1 million, the player can leave anytime with the money associated with the highest previous level reached. This applies in both cases: when a player voluntarily chooses to leave the game and/or when the player gets an incorrect answer.

The two subject areas chosen for this study were Numeracy and Te Reo (Maori language). Numeracy was chosen because a large number of students had identified numeracy in the questionnaire as one of the areas they wanted to play games in. The New Zealand Numeracy Curriculum was used in order to determine the level of question suitable for the children selected for the study. In order for the game to be enjoyable and engaging, it was necessary that the players were given the type of questions of which they had prior knowledge and which were not extremely difficult or “boringly” easy (e.g. a good solution was to provide a progressive level of skills). Their teachers were consulted and the numeracy levels of the children were taken into consideration. Te Reo (Maori Language) was chosen to be the second subject to teach, since this was an area of learning in which there were very limited educational games. Te Reo is a component of the NZ Primary School curriculum. The teachers of the selected group of students were again consulted to find out what competency level the students were in Te Reo. The questions designed for the Te Reo game were then compiled in line with the children’s competence. The questions were based around identifying everyday items, recalling numbers, naming the colour range, as well as naming the days of the week. The children in the study group were expected to have prior knowledge on these topics. We developed two versions. The first version was a Feature Enriched Game (FEG) which had extensive use of the three identified features (i.e. CH, FB & GH) and the second version, a Feature Devoid Game (FDG) had overt absence of these features. To learn more about the proposed features and how they were integrated into FEG version of the game, refer to our earlier work (Nand et al, 2013).

4. Evaluation Study

Our research questions in this study are as follows: 1) How will the domain of the game (Literacy vs

Numeracy) affect users' learning outcome? 2) Do children enjoy using the proposed educational tool with the embedded characteristics?

The Evaluation study was conducted with 120 children aged 9-10 at Glen Eden Primary School in Auckland. The participants were divided into a Control group and a Test group of 60 students each. Both groups were pre-tested firstly on the numeracy learning outcomes. The Test group was given the FEG version to play over a period of two weeks and the Control group was given the FDG version to play over two weeks. Both groups were given post tests on the numeracy learning outcome. Both groups were then pre-tested on the Te Reo learning outcome. The test group was given the Te Reo FEG version to play over a period of two weeks and the Control group was given the Te Reo FDG version to play over two weeks. Both groups were given post tests on the Te Reo learning outcome.

Both FEG and FDG versions of the game were installed on the 12 available computers in the school library and as time permitted, pupils in groups of 12 were given the games to play in a separate room with the computers. Both Control and Test groups played at different times and were not able to see what version of game each group was playing. There was a deliberate attempt to keep the two group's playing times separate. The students were allowed to play the game for about 20 minutes without any interference from the researcher or any of the other teachers. At the end of a maximum of 30 minutes the students were stopped and allowed to go back to their classrooms.

4.1 Measuring Children's Learning

Measuring children's learning was our main dependent variable. In order to do that, we used a pre-test, post-test and interaction logs. The pre-test was conducted to measure student knowledge before using the educational tool and the post-test was used to measure the learning outcome after using the educational tool. The questions in the tests were similar to the ones used by teachers in assessing their students in numeracy and their knowledge of Maori language. The pre-test and the post-test for each of the curriculum areas were done using the same questions. This gave us a direct measurement of the change in the learning outcome. The results are reported in Table 1.

Table 1a: Statistics for the Pre and Post Scores for the Numeracy experiment

Statistic	Control Group		Test Group	
	Pre Test	Post Test	Pre Test	Post Test
Count	60	60	60	60
Average	12.12	12.97	12.87	14.77
Std. Dev.	4.30	4.21	4.55	3.51
Relative Std. Dev. (%)	35.5	32.5	35.4	23.8

Table 1b: Statistics for the Pre and Post Scores for the Te Reo experiment

Statistic	Control Group		Test Group	
	Pre Test	Post Test	Pre Test	Post Test
Count	60	60	60	60
Average	8.35	8.85	10.52	14.18
Std. Dev.	3.47	3.41	3.22	3.42
Relative Std. Dev. (%)	41.6	38.6	30.7	24.1

As we can see, the average scores for both domains have increased after playing both versions of the game. For numeracy domain (Table 1a), the average for the control group has increased from 12.12 to 12.97 and for the test group, has gone up from 12.87 to 14.77. In addition, the absolute score for these equate to an increase of 0.85 or 7% for the control group and an increase of 1.9 or 14.8% for the test group. Thus, the percentage increase in the mean score is twice as much for the FEG compared to the FDG game. Comparison of the post-test scores for the control and the test groups (12.97 compared to 14.77) also shows that the FEG was more effective in raising the performance level of the students. The T-Test values are 3.63×10^{-10} for the Control group and 1.31×10^{-31} for the Test group. Both values are orders of magnitude smaller than 0.05, showing that the change in the learning outcome (post-test vs pre-test) was statistically significant for both groups. Additionally, the T-Test value for the Test group is orders of magnitude smaller than the Control group, implying a significant effect of the FEG. The

corresponding figures for the Te Reo game is 0.5 or 6% increase for the control group compared to 3.66 or 34.8% for the test group. This gives us an approximately 6 fold increase in the learning score for the Te Reo experiment. The results in the case of the Te Reo curriculum also show a similar pattern to the Numeracy curriculum, in that the test group performed better compared with the control group.

In addition, the participants in the Test group (for both Numeracy and Te Reo domains) attempted more questions in average, provided more correct answers, spent more time playing the game and reached more levels compared with the Control group – this indicates that the FEG version was better utilised compared with the FDG.

4.2 Analysis of Post-Game Questionnaire Responses

After playing the FEG and the FDG versions of the game over a period of four weeks, the students were given a questionnaire to fill out in order to collect information about their perception of the game. Figure 2 shows the participants’ responses to whether they would recommend the game to their friends. As it can be seen, the students in the Test group were more likely to recommend the game to their friends (38 definitely and 17 possibly). On the other hand, very few students in the Control group were likely to do so (1 definitely and 9 possibly). A little more than half of the students in the Control group (17 not at all and 24 not really) said they would not recommend the game, as opposed to only 1 student in the Test group.

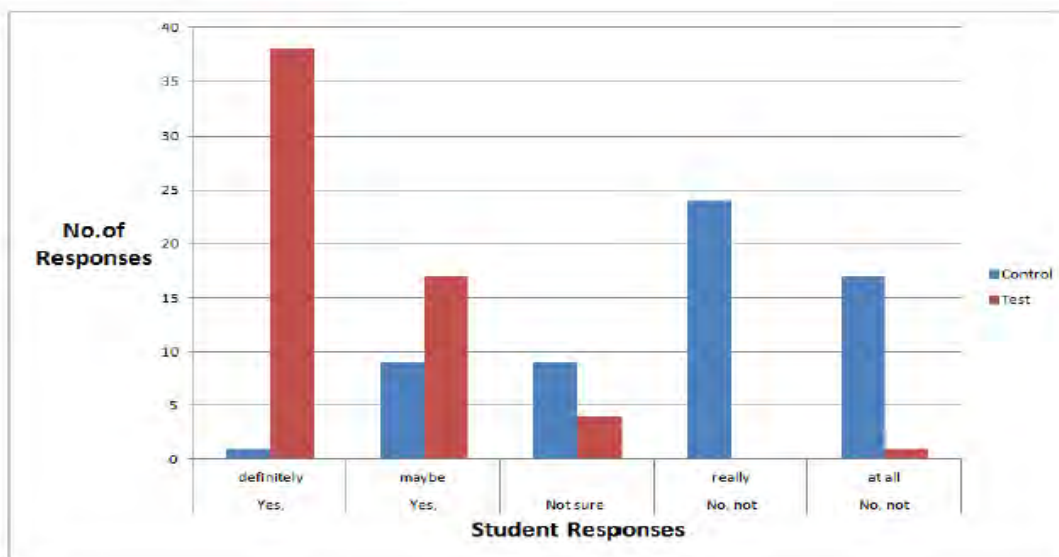

Figure 2. Students’ responses to whether they would recommend the game to their friends?

Our results also show that the Test group enjoyed playing the game more than the Control group and was more inclined to want to play the game again. We believe that the presence of the key three features, i.e., the sound & visuals effects, level of challenges in the game and the feedback messages contributed more to their engagement. The FDG version, used by the Control group, was devoid of those features, which resulted in them not wanting to play the game again nor wanting to recommend it to their friends. Moreover, visual observations of students while playing the game showed that the Test group was more engaged and excited with the sound and the graphics compared to the control group. Their expressions and body language demonstrated that they were motivated to keep on playing and they finally had to be stopped at the end of the session. Some of the participants, for example, were shouting in delight when they were given feedback about their answers, smiled and talked to their friend sitting next to them often and shared how they were progressing in the game. On the other hand, the Control group playing the FDG version looked less interested and engaged, and some of them asked if they could leave the session earlier. The game did not seem to hold their attention as they were seen to be fidgeting and their attention seemed to drift from the game to observe what others in the room were doing.

5. Conclusions & Future Work

In this paper, we examined the effectiveness of our educational tool in enhancing students' knowledge of Numeracy and Maori Language, as well as conducting a subjective analysis amongst the participants. The tool is designed based on the characteristics of engaging computer games identified in our previous study, i.e. graphics (GH), feedback (FB) and challenge (CH). We conducted the evaluation study with 120 primary school children aged 9-10, at Glen Eden Primary School in Auckland. The main dependent variable used was the amount of learning that took place, measured with the use of pre-test and post-test and user interaction data.

The results showed that the proposed features embedded into the learning tool were effective in significantly improving learning outcomes. The results of the subject analysis indicated that the Test group enjoyed playing with the game more than the participants in the control group and that the sound effects, the visual effects, the level of challenges and the feedback messages contributed more to their engagement. The test group is also more likely to want to play the game again. We also found that the test group did significantly better when working on the Te Reo questions than Numeracy. The much greater increase in the learning outcome score for Te Reo indicates that the educational tool was especially effective for this curricular. This can be attributed to the difference in the types of learning involved in the two curricula. Te Reo involves fact-based learning where the student is required to learn and recall facts. On the other hand, the Numeracy learning task is based on problem solving; it involves more fact manipulation operations and various intermediate steps in order to arrive at the final answer. The intermediate steps were not fully supported in the current version of the tool designed for this study. In spite of this, the FEG version significantly improved learning outcomes for Numeracy, which can be even further improved by adapting the game for more fact manipulation or cognitive based curricula.

An immediate future work identified from this study is to adapt the game for more cognitive based learning tasks. In addition, a more comprehensive set of questions with intermediate questions can be developed in the game to guide the user to a final answer. It would be interesting to see if the effectiveness of the feature enriched educational tool would also be valid in other scenarios such as for secondary school children and in other curriculum areas. We also plan to conduct a long-term study to find out if there will be significant increase in learning outcomes and amount of enjoyment as opposed to a two week study. We believe our research paves the way for the systematic design and development of full-fledged engaging educational tools.

References

- Alankus, G., Lazar, A., May, M. and Kelleher, C. Towards Customizable Games for Stroke Rehabilitation. In Proc. Int. Conference on Human Factors in Computing Systems (CHI 2010), ACM Press: Atlanta, GA, USA.
- Chen, G., Baghaei, N., Sarrafzadeh, A., Manford, C., Marshall, S. & Court, G. (2011). Designing games to educate diabetic children. In Proc. Australian Computer-Human Interaction Conference (OZCHI 2011).
- Consolvo, S., Everitt, K., Smith, I., and Landay, J. A. Design Requirements for Technologies that Encourage Physical Activity. In Proc. Int. Conference on Human Factors in Computing Systems (CHI 2006), ACM Press.
- Csikszentmihalyi, M. (1990). *Flow: The psychology of optimal experience*. London: Harper Perennial.
- Dondlinger, M. J. (2007). Educational Video Game Design: A Review of the Literature. *Journal of Applied Educational Technology*, 4(1), 21-31.
- Fisch, S. M. (2005). Making educational computer games "educational". Paper presented at the 2005 Conference on Interaction design and children, Boulder, CO.
- Fujiki, Y., Kazakos, K., Puri, C., Buddharaju, P., Pavlidis, I., and Levine, J. NEAT-o-Games: Blending Physical Activity and Fun in the Daily Routine. *ACM Computers in Entertainment* 6 2(2008).
- Malone, T. W. (1981). Toward a theory of intrinsically motivating instruction. *Cognitive Science*, (4), 333-369.
- Nand, K., Baghaei, N., Casey, J. Play & Learn: Designing Engaging Educational Games for Children. *Int. Journal of Cognitive Technology*, vol. 18, no. 1, 2013.
- Pinelle, D; Wong, N; & Stach, T. (2008) Heuristic Evaluation for Games: Usability Principles for Video Game Design. In M.Czerwinski, A.M. Lund, & D. S. Tan (Eds.): In Proc. Conference on Human Factors in Computing Systems (CHI 2008), ACM: Florence, Italy.
- Premsky, M. (2001). *Digital Game-Based Learning*. McGraw Hill: New York.
- Rogoff, B. (1990). *Apprenticeship in thinking: Cognitive development in social context*. New York, NY: Oxford University Press.
- Vygotsky, L. (1976). Play: It's role in development and evolution, chapter Play and its role in the mental development of the child, pages 537-554. New York, NY: Penguin Books.

Learning English Words via Visual Media using Tablet PCs

Kaoru Sumi^{a*} & Ayaka Kazuhara^{a*}

^a*Department of Media Architecture, Future University Hakodate, Japan*

*kaoru.sumi@acm.org

Abstract: A tablet PC system using an etymological memorization method with animations can enable Japanese children to memorize English words. The system specifically helps with memorization of compound nouns, which are combination of two simple nouns, for animals. For each noun it shows an animation with a narration produced by a voice synthesizer, followed by an animation showing the compound noun, again with narration. The system was experimentally evaluated by comparing the effectiveness of using animation, pictures, and text.

Keywords: Learning English Words, Etymological memorization method, Tablet PCs.

1. Introduction

We have developed a system of iPad applications that is effective in enabling children to memorize English words yet enjoy themselves while learning English. The system specifically helps with memorization of compound nouns, which are combination of two simple nouns.

A compound noun is a combination of two or more simple nouns such that the meaning can be derived from the meanings of the simple nouns. We think that this concept is important for training English learners at an early age, because children come to understand the meanings of various words by considering etymology. For example, Japanese students have difficulty predicting the meaning of a new English word, because Japanese and English are so different. In particular, it is difficult to cope with a complex English word at first sight. The meaning can be made predictable, however, by dividing the word and thinking about the etymology of each part. Using this approach, students can learn many English words that they do not already know. In Japan, full-scale English education starts from junior high school. We want to encourage children to maintain this applied word learning skill for future English learning, and that is why we developed this system of iPad applications before entering junior high school.

Therefore, in our system we apply an etymological memorization method (Zhang and Han 2004), which entails learning compound words by being conscious of the origin of each constituent word. For example, “centipede” consists of “centi” (hundred) and “pede” (foot). The idea is that the learning effect should be increased by learning words via animations for understanding both compound nouns and their constituent simple nouns.

Our group has extensively researched content understanding through animation and shown that animations are effective for understanding content and vocabulary (Sumi and Tanaka 2005), (Sumi and Nagata 2011), (Sumi and Nagata 2012). In general, animations have been shown to improve understanding and recall of text, making them an effective tool for promoting learning (Levie and Lentz 1982). Research has also shown that animations increase motivation to learn (Rieber 1991). This paper introduces our system and presents a comparative evaluation with elementary school students as subjects using the system with animations, pictures, and Japanese characters.

In addition, we think that after a student learns compound nouns, improvement in long-term memory is possible through the opportunity to use those nouns several times. For example, consider the case of building a simple sentence by combining a noun and a verb. Therefore, our system also has a function for sentence construction, in which the student combines memorized compound nouns and verbs and views corresponding animations.

As for the effect of the etymological memorization method, research has verified its learning effect and indicated the advantage of being able to imagine the meaning of an unknown word by being conscious of etymology (Kikuchi 2011). Another study (Suzuki 2011) examined etymology learning by showing

English words corresponding to Japanese words. This study involved changing the colors of the constituents of a compound noun and showing the whole noun, with a beneficial learning effect for some subjects. We thus adopt the technique in our system of separating English words by color according to etymology.

The field of second language acquisition attaches importance to conveying a message through the meaning of the language rather than focusing on the form of the language. The etymological memorization method corresponds to such basic learning for conveying a message, since learners understand the meaning of the language. This system is also related to the classic flash card systems of computer-assisted language learning (CALL).

This paper investigates the additional effects of animations, pictures, and characters. The sentence construction application entices children to generate an animation by choosing a noun and verb intuitively. It aims to imprint English words on students' memories via learning in an enjoyable way.

2. English Vocabulary Learning Applications

The system consists of four applications: "English Vocabulary," "Sentence Construction," "Vocabulary Quiz," and "Word Meaning Deduction Quiz." The "English Vocabulary" application operates in three different ways, using animations, pictures, or Japanese characters, to compare the effects of these three approaches. The picture and Japanese character approaches respectively show a freeze frame of a picture or Japanese characters representing a noun. In contrast, the animation approach expresses an explanatory state in which, for each noun, an animated animal appears and coalesces from a smoke screen, so that the application finally shows the animal corresponding to a compound noun.

We chose animal nouns as the target words because they are familiar to children. The field of second language acquisition considers background knowledge important for understanding input (Krashen 1985). To make learning more effective by exploiting the learner's field of interest (Shirai 2004), we thus chose animal words.

After learning compound animal nouns, students can use the Sentence Construction application to build sentences using the compound nouns while seeing animations of the corresponding animals. Students then use the Vocabulary Quiz application to confirm how many words they have memorized. We also developed the Word Meaning Detection Quiz application to see if children could deduce the meanings of unlearned compound nouns merely from hints in the form of simple nouns. The system keeps track of the current time, the class, the student number, the application, and the student's numbers of correct and incorrect answers.

All applications were developed using Adobe Flash Professional CS6, Adobe AIR for iOS, and ActionScript 3.0. All icons and pictures were created using Adobe Illustrator CS5. Sound for words in English was obtained from Google's speech synthesis system with words recorded beforehand in MP3 format. The system was designed to clearly express English words through pictures and animations and to support intuitive operation leveraging the benefits of the iPad.

2.1 English Vocabulary application

As noted above, the English Vocabulary application operates in one of three ways, using animations, pictures, or Japanese characters. We chose compound nouns for ten kinds of animals. In a preparatory experiment, we confirmed that ten English compound nouns in our system were not familiar to Japanese fifth and sixth graders, although they knew the Japanese words for these animals. We concluded that memorization of ten words was a sufficient challenge for these students.

The starting screen displays icons for these ten compound nouns. Touching one of the ten icons switches the screen to the corresponding learning screen for the compound noun. Touching the "?" button causes the animation (or picture, or Japanese character) corresponding to the word to be shown on the screen, with the sound of the word in English played at the same time. Similarly, touching the "=" button causes the application to show the animation (picture, character) and play the sound corresponding to the whole compound noun. Furthermore, the animation shows the process of joining the two English words forming the compound together. The sound can be replayed by touching the icon.

2.2 Sentence Construction Application

The Sentence Construction application is designed to promote long-term word memorization through sentence construction. The student chooses a compound noun, which has already been learned, and a simple verb. The starting screen displays icons for the ten compound nouns and ten suitable verbs. The compound nouns, listed on the left side, and the verbs, listed on the right side, can be selected by dragging each into the respective left or right part of the center area. The animation for the resulting sentence then appears in the lower part of the screen.

2.3 Vocabulary Quiz Application

The Vocabulary Quiz application is used to confirm whether the student was able to memorize the compound nouns. The application provides two kinds of quizzes, called Test 1 and Test 2. In both tests, upon seeing the corresponding characters and hearing the corresponding sound, the student chooses an answer by selecting one of four icons to represent the compound noun. In Test 1, the four answer choices consist of two of the compound nouns, including the correct answer, and two simple nouns. In Test 2, the four choices consist of three compound nouns and one simple noun. For the word test in our experiment we adopted Test 2, which is more difficult than Test 1, according to the results of a pre-test experiment with children.

The spoken compound noun can be replayed by touching the button next to the word. If the student selects the right answer, the application switches to a “correct answer” screen with a corresponding sound. Likewise, if the student selects a wrong answer, the application switches to an “incorrect answer” screen with a corresponding sound. One of six different screens is finally shown according to the number of correct answers.

Note here that our system keeps track of the current time, the class, the student number, the application, and the student’s numbers of correct and incorrect answers.

2.4 Word Meaning Deduction Quiz Application

This application is used to confirm whether the student can deduce the meaning of an unlearned compound noun from the etymology of English words. As in the Vocabulary Quiz application, this etymology quiz lets the student choose an answer by selecting one of four icons expressing a compound noun, upon seeing the corresponding character and hearing the corresponding sound. Because this test has a high difficulty level, the system shows hints in the form of pictures and characters for words with helpful etymology.

3. Experiment

We held an English learning workshop using our system with 111 children: 34 sixth graders (20 boys, 14 girls), and 77 fifth graders (38 boys, 39 girls). We analyzed the following issues: (1) comparison among media, in terms of which media are effective for memorizing nouns; (2) whether sentence construction is effective for memorizing English words; (3) whether the system differs in effectiveness depending on experience in learning English; (4) whether the system differs in effectiveness depending on cognitive style; (5) and whether, after learning nouns, students find sentence construction by combining a noun with a simple verb effective for memorization.

We used the Vocabulary Quiz application as a word test, and the Word Meaning Deduction Quiz application as an etymology test.

To compare effectiveness, we also developed English vocabulary applications using pictures and Japanese characters, in addition to the application using animations.

We pretested and distributed the subjects into five groups, without differentiation according to gender, English learning experience, or cognitive style. A chi-square test showed no significant difference in bias in the number of subjects for any cross tabulations. The allotment to each group was thus non-biased.

Group 1 used the English Vocabulary application with animations and the Sentence Construction application. Group 2 used the English Vocabulary application with pictures and the Sentence

Construction application. Groups 3, 4, and 5 used only the English Vocabulary application, with animations, pictures, and Japanese characters, respectively. We used the Group Embedded Figures Test (GEFT) to screen cognitive styles. The GEFT involves looking for a specified figure from among various provided figures. It consists of seven practice questions as the first section (two minutes), and 18 real questions as the second and third sections (five minutes each). We measured how many figures children could identify before running out of time. Then, we classified children with zero to nine correct answers as having a field-dependent cognitive style, and those with 10 to 18 correct answers as having a field-independent cognitive style. We translated the GEFT into Japanese because the original GEFT is in English.

Note here that the cognitive style (either field-dependent or field-independent) refers to how people classify personal characteristics, according to differences in the methods used to receive, constitute, analyze, and remember information and experiences (Hojo 1991). People with a field-dependent cognitive style receive the structure of an image as shown, without revising it, and they interact with it. They fuse all elements in the field of vision, without dividing what they see into visual components. On the other hand, people with a field-independent cognitive style consider an image to be a visual stimulus. They can either decompose the image when it is organized or add an original structure when it is not organized. As a result, these people can precisely distinguish specific information in a complicated picture (Moore and Dwyer 1991). For junior high students with a field-independent cognitive style, Hojo (Hojo 1991) found a strong learning effect when they used pictures in English learning. He concluded that because the analysis and estimation abilities of field-independent learners are superior for coping with this problem, they can use information from a picture more effectively.

Before this main experiment, we conducted a preparatory experiment using our system with 18 children at a different elementary school. The subjects used the English Vocabulary application with animations (or pictures). Through this experiment we (1) determined the number of repeated times using the system required to learn an English word, and we confirmed (2) the adequacy of the difficulty of the words and quiz and (3) the system's user-friendliness. We found that there was a difference in the number of times required when the students used the system freely within a limited time. Therefore, we revised the system to maintain a consistent number of times for learning, and we also decided to develop an application using Japanese characters, because there was little difference in results between the animation and picture cases.

As comparison among media, analysis of variance showed no significant difference in scores after using the three different media ($F(2,43) = 0.17, p < .05$).

As effectiveness of sentence construction, there was no significant difference in word test scores between Groups 1 and 2 ($t = -0.75, df = 63, n.s.$). On the other hand, there was a significant difference in etymology test scores between these groups ($t = -2.56, df = 63, p < 0.05$). This suggests that deducing new English words was easier using the application with pictures than using the application with animations.

As effectiveness depending on differences in English learning experience, There was a significant difference in scores between Groups 1(experienced) and 2(experienced) ($t = -2.35, df = 63, p < 0.05$). That is, among the subjects with English learning experience, the application using pictures was more effective than that using animations, before sentence construction. There was also a significant difference in scores between Groups 2(non-experienced) and 2(experienced) ($t = -2.96, df = 32, p < 0.05$). This means that in the case of learning using the application with pictures, the subjects with English learning experience performed better than did the non-experienced subjects.

The average etymology test scores were also categorized by English learning experience. There was a significant difference in scores between Groups 1(experienced) and 2(experienced) ($t = -2.22, df = 63, p > 0.05$). That is, among the subjects with English learning experience, the application using pictures was more effective than that using animations. There was also a significant difference in scores between Groups 1-1 and 2-1 ($t = -1.81, df = 17, p > 0.05$). This means that among the non-experienced subjects, as well, the application using pictures was more effective than that using animations for deducing new English words. Lastly, there was a significant difference in scores between Groups 2(experienced) and 4(experienced) ($t = 2.28, df = 47, p > 0.05$). In other words, among the subjects with English learning experience, the application using pictures was more effective than that using animations for deducing new English words.

4. Discussion

Our analysis showed that the English Vocabulary application using pictures, rather than animations or Japanese characters, was the most effective for memorization. In particular, the system was effective for subjects with experience learning English. Moreover, the application using pictures was more effective for children with a field-independent cognitive style than for those with a field-dependent style. Another interesting result was that, for recalling memorized English words one week later, learning with both the English Vocabulary application (using pictures or animations) and the Sentence Construction application was better than learning only with the vocabulary application (using pictures or animations). This demonstrates the effectiveness of sentence construction for learning English vocabulary, thus confirming our hypothesis that building sentences with the Sentence Construction application after learning English words should have a learning effect, specifically for long-term learning.

After the experiment we administered questionnaires to the subjects, offering the chance for free response, and we gleaned the following opinions. For the question, "Were the positions and colors of screen icons easy to recognize?", there were many favorable comments. Examples include "The application was very colorful and characters were easy to recognize," "The icons for '? + ? =' were easy to comprehend," and "It was easy because of the sounds played with the words."

For the question, "Was learning English fun?" there were also many favorable comments. In this case responses include "It was very fun, unlike learning from a textbook," "I have come to like English so far, though it was hard," "It was fun because of the Sentence Construction application," "I thought it was very good that I could learn English while playing a game, and it was fun," "I could learn English like a game and it was fun," "The Sentence Construction application was very fun," and "It was good to learn even with a quiz."

For the question, "Was learning English easy?", as well, there were many favorable comments. Examples for this question include "It was easy, because the system spoke the words," and "It was easy, because the words were made up of other words." Other comments include "Though it was difficult, it was fun," and "It was sometimes difficult and sometimes easy."

Finally, for the question, "Was it easy to learn English with this method?", there were also many favorable comments. In this case responses include "Because I understood the pronunciation by hearing it and the English was written, it was easy to learn," "Because I could hear the sound, it was easy," "I could learn English with this system rather than by having someone explain it," "It was easy to understand, because of the audio pronunciation," "It attracted everyone's interest that we could use an iPad system with sound," and "It was easy to learn more than usual, because we always learn English only by hearing."

The field of image psychology postulates that learning effects are determined by such factors as "variables in the image," "characteristic differences in the actor," and "the kind of problem." Here, "variables in the image" refers to media, such as animation. The phrase "characteristic differences in the actor" means the subject's ability. Finally, "the kind of problem" means the problem to be solved, such as learning English words. In this case, we investigated the problem of learning English words by using animations, pictures, and Japanese characters, for children who either do or do not have English learning experience and have either a field-dependent or field-independent cognitive style.

Our hypothesis was that the learning effect would be enhanced by using animations for learning English words, and we thus expected that animations would have a higher effect on learning than would pictures or characters. The learning effectiveness of showing a picture or animation with text was demonstrated in studies by (Cowen 1984) and (Peeck 1974). Additionally, because animation can express the process of combining two English words to create a compound noun, we thought that animation should produce better results than with pictures or characters. For example, the system can present an explanatory animation of an animal noun appearing and coalescing beyond a smoke screen. We found, however, that such explanatory presentations through animation had little or no value and no relation to memorizing English words. It might be that unnecessary movement disrupts memory, or there might be a more suitable speed for presenting images to promote memorization. According to (Levie and Lentz 1982), visual representations have both a cognitive function that facilitates learning from text by improving understanding and retention, and an attentional function that attracts attention to the content. Visual representations could obstruct learning, however, when they capture the learner's attention, because visual representations themselves contain mixed information (Levie and Lentz 1982). Thus, we

conclude that our experimental result for the animation condition was caused by the explanatory animations attracting the learner's attention and obstructing learning.

As a result, the child subjects could gain interest in English learning and learn in an enjoyable way via our iPad-based system. By using the system's applications to repeat the cycle of learning through memorizing, building sentences, watching animations, and taking a quiz, the elementary school children became more familiar with English, more aware of etymology, and more prepared for further English learning in junior high school.

5. Conclusion

In this paper, we have introduced an iPad-based system to help Japanese students learn English compound nouns while having fun. The system consists of four applications: "English Vocabulary," "Sentence Construction," "Vocabulary Quiz," and "Word Meaning Deduction Quiz." We conducted an experiment with our system and analyzed the results in terms of various subjects and conditions.

As a result, the English Vocabulary application using pictures, rather than animations or Japanese characters, was the most effective for memorization. In particular, the system was effective for subjects with experience learning English. Moreover, the application using pictures was more effective for children with a field-independent cognitive style than for those with a field-dependent style. For recalling memorized English words one week later, learning with both the English Vocabulary application (using pictures or animations) and the Sentence Construction application was better than learning only with the vocabulary application (using pictures or animations).

Acknowledgements

We would like to thank Akagawa and Showa Elementary Schools in Hakodate, Japan, and the undergraduate students at Future University Hakodate, who helped with our children's workshops.

References

- Cowen, P.S. (1984). Film and text : Order effects in recall and social inference. *Educational Communication and Technology Journal*,32, 131-144.
- Hojo, R. (1991). Basic study on effect of the image in the foreign language education2. *Visual education study*, 21, 55-67. In Japanese.
- Kikuchi, A. (2011) . An Attempt on Vocabulary learning using etymology, *Hachinohe Kogyo Senmon School Journal*, 46, 119-123.
- Krashen, S.D. (1985), *The Input Hypothesis: Issues and Implications*, New York: Longman.
- Levie, W.H. & Lentz, R. (1982). Effects of text illustrations :A review of research, *Educational Communication and Technology Journal*, 30, 195-232.
- Moore, D. M., & Dwyer, F. M. (1991). Effect of color coded information on students' levels of field dependence. *Perceptual and Motor Skills*, 72, 611-616.
- Peeck, J. (1974) . Retention of pictorial and verbal content of text with illustration, *Journal of Educational Psychology*, 66, 880-888.
- Rieber, L. P.(1991). Animation, Incidental Learning, and Continuing Motivation, *Journal of Educational Psychology*, Vol.83. No.3, 318-328.
- Shirai, Y. (2004). A person succeeding in foreign language learning and the person who do not succeed: Invitation to a second language acquisition theory. Iwanami Science Library. In Japanese.
- Sumi, K. and Tanaka, K. (2005). Automatic Conversion from E-content into Virtual Storytelling, published in Gerard Subsol ed., *Virtual Storytelling, LNCS 3805, Springer Lecture Note in Computer Science*, pp.262-271, Springer.
- Sumi, K. and Nagata, M. (2011). Interactive e-Hon as Parent-child Communication Tool, *HCI 12, volume 6772 of Lecture Notes in Computer Science*, page 199-206, Springer.
- Sumi, K. and Nagata, M. (2012). Animation for Supporting Parent-and-Child Communication, *Handbook: "New Horizons in Creative Open Software, Multimedia, Human Factors and Software Engineering"* :Blue Herons Editions.Suzuki, T.(2011). About learning Katakana-words and English abbreviations in ICT , *IPSJ*,2011-CE-111(6), 1-4, 2011-10-07
- Zhang, B. & Han, W. (2004). A Study on Presentation Models in English Vocabulary Teaching [J]. *Foreign Languages and Their Teaching* 4: 005.

On the Design of Embodiment-based Gamification Activities for Learning Fundamental Projectile Motion

Shih-Chieh WANG, I-Chun HUNG, Li-Chun LIN, Nian-Shing CHEN*

*Department of Information Management, National Sun Yat-sen University, Taiwan
stu8620125@hotmail.com, ichung@mis.nsysu.edu.tw, zoelclin@gmail.com,*

**nschen@mis.nsysu.edu.tw*

Abstract: Based on theories of embodied cognition, this study applied technologies of natural user interface to design gamification activities for learning fundamental projectile motion. The embodiment-based design facilitates elementary learners to learn the abstract concept of fundamental projectile motion through their body-moving experience. When the learners perform gamification activities with their body movements, they can construct their knowledge schema through external perceptions. This study recruited 60 fourth to sixth grade students to participate the experiment. The participants were randomly and equally divided into body-moving learning group and finger-touching learning group. The learners in the body-moving learning group directly use their body movements to accomplish the gamification learning activities. On the other hand, the learners in the finger-touching learning group have to hold a tablet PC and use only their fingers for all operations. Participants' learning performance was evaluated through tests of factual knowledge and procedural knowledge. The result shows that the body-moving learning group outperformed the finger-touching learning group on speed in the factual knowledge test and projectile angle in procedure knowledge test. No significant difference was found in the rest of test items.

Keywords: Embodied cognition, embodiment-based learning, natural user interface, elementary gamification activities, projectile motion

1. Introduction

Literature of embodied cognition suggests that human cognition consists of mental model simulation, environment, situated action and bodily state (Barsalou, 2008, 2010; Lankoski & Järvelä, 2012; Rambusch, 2006). Learning with the support of body movements, external perception, and environment information is helpful for internal knowledge construction (Arjoranta, 2013; Barsalou, 2010). Pointing gestures, representational gestures, and metaphoric gestures can be exploited for enhancing memorization and improving comprehension (Martha W. Alibali & Nathan, 2012). Macedonia, Müller, and Friederici (2011) found that iconic gestures can better facilitate language learning than meaningless gestures. Currently, learners usually interact with most learning systems through physical controllers and mobile devices such as mouse, smartphone and tablet PC. However, the controller-based interaction is limited to provide enough external perception for a clear understanding when learning abstract concepts in natural science subjects.

Previous research suggests that learning with adequate strategies and technologies can facilitate learners' comprehension of abstract concepts, knowledge construction, and learning performance improvements. Educational computer games can motivate learners, draw their attention on learning content, and improve their learning outcome (Cagiltay, 2007; Tüzün, Yılmaz-Soylu, Karakuş, İnal, & Kızılkaya, 2009). For example, Sung and Hwang (2013) designed a collaborative game with a grid-based Mindtool for elementary school students to learn characteristics of plants and the learners obtained improved learning achievement. The learners' attitudes, motivation, academic record, and self-efficacy were better promoted after playing the game. Howison, Trninic, Reinholz, and Abrahamson (2011) utilized Wii Remote controller to provide gesture-based interaction between learners and learning system and help the learners learn the concept of numerators and denominators. Learning with such kind interaction by using body movements can help learners deal with the cognitive conflict

between their thoughts and observational operations for better comprehension. Hao et al. (2010) utilized a webcam to develop a Wii-like, vision-based motion game for learning the stroke order of Chinese characters. The result shows that learners can memorize well the stroke order of Chinese characters and achieve better learning outcomes. The interaction between a learner and a learning system is depended on the design and representation of learning materials. Also, simulation is a form of interactive multimedia. For example, a virtual laboratory can be created and simulated for an experimental process without imposing any physical dangers on learners (Annetta et al., 2014).

Learners can have authentic understanding if they actually conduct a natural science experiment and experience everything that occurs with their own bodies during the experimental process. From the perspective of embodied cognition, external perception and internal mental model simulation both contribute to create cognition. Learning by doing is a practical method and can make learners situate in a rich context. During the learning process, learners' body movements can help them to understand the learning content with a reflection of previous learning and daily life experience (Anastopoulou, Sharples, & Baber, 2011; Shapiro, 2014). For example, with the body participation, multimedia materials, and simulation exercises, learners can successfully bridge the gap of abstract concept and real world to learn fundamental optics better (Hung, Lin, Fang, & Chen, 2014). Chao, Huang, Fang, and Chen (2013) successfully improved learners' memorization of English vocabulary and phrases by using a gesture-based learning system. Kuo, Hsu, Fang, and Chen (2014) implemented total physical response (TPR) approach with an embodiment-based design to facilitate English vocabulary learning. The result shows that the retention of the learners in the embodiment-based TPR group was better than those in the conventional TPR group.

This study applied technologies of natural user interface to design gamification activities for learning the fundamental projectile motion of physics. Another aim of the study was to test if the learners are able to transform what they have learned into real-life practices and applications.

2. System Design

Projectile is an object projected by external force. Projectile motion describes the process regarding how the projectile moves, and it can be easily observed in people's daily life. In this study, the learning content is fundamental projectile motion of physics including two learning goals. The first one is how the projectile parameters change in terms of the moving distance and the angle when the initial speed is fixed. The second one is how the projectile parameters change in terms of the moving distance and the initial speed when the angle is fixed.

After considering the learning goals and the age of the target learners, the Angry Birds game is exploited to design an elementary gamification activity. Based on embodied cognition, education computer games can be implemented with a role-playing feature and the players can link the gaming experience with their daily lives (Lankoski & Järvelä, 2012). The gaming events and operations in the Angry Birds game are consistent with the learners' daily experiences and the knowledge behind the game regards fundamental projectile motion of physics.

Based on the perspective of embodied cognition, this study utilizes technologies of natural user interface to make learners be able to interact with the learning system through their body movements. The Angry Birds game is adopted to convey the abstract concept of fundamental projectile motion with learners' body-moving experience. In Figure 1 (a), the body-moving learning system consists of a Microsoft Kinect sensor, a laptop, and a big display. The Microsoft Kinect sensor was used to build the learning environment capable of sensing learners' movements. The learning system was developed in C# and executed with the Angry Birds PC game on the laptop (Figure 1 (b)). The external display is to provide learners a big visual area for watching the game details because the learners have to stand in front of the sensor about 2~3 meters and the laptop screen is too small.

Three gestures were designed for playing the game to enable learners to simulate the process of projectile motion. First one is that learners swing their right hand at different speed to control the projectile initial speed. Another one is that learners raise their left hand at different height to adjust the projectile angle. The last one is that learners raise both hands to confirm the adjustments regarding projectile initial speed and projectile angle, and then an angry bird is launched to hit targets. The top area of the system screenshot provides learners operational guides with pictures and text to prompt related functionalities for game playing. When learners move their hands, this area instantly present every position changes of their hand skeletons. The bottom area is the game area of the Angry Birds.

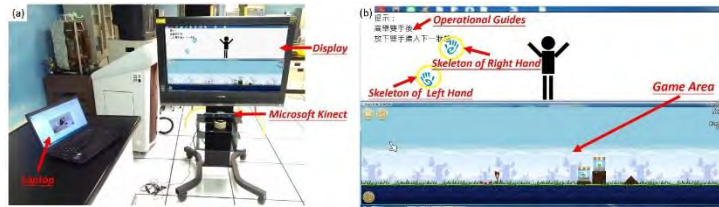

Figure 1. The body-moving learning's (a) environment setup; (b) system screenshot.

The finger-touching learning system is the Angry Birds game which runs on a FIC Tycoon 10.1-inch multimedia tablet PC. All operations are finished by finger-touching. In this case, learners play the game according the two learning goals. Compared to the body-moving learning, the finger-touching learning barely provides learners external perception related to the abstract concept of the learning content (Figure 2).

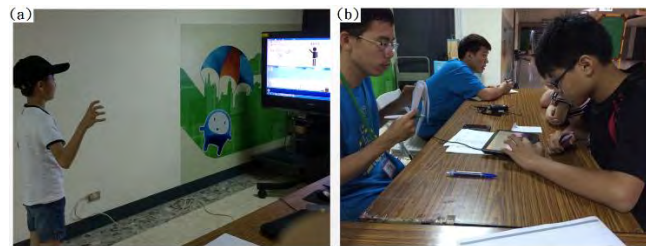

Figure 2. Learners in (a) body-moving learning; (b) finger-touching learning.

3 Method

This study applied technologies of natural user interface into elementary gamification activities for learning fundamental projectile motion. In order to evaluate learners' performance, an experiment was conducted including the body-moving and finger-touching learning groups. Krathwohl (2002) proposed the structure of the knowledge dimension of the Revised Bloom's Taxonomy including factual knowledge, concept knowledge, procedure knowledge, and metacognition knowledge. Factual knowledge regards the terminology of learning content that learners have to know. Procedure knowledge concerns that learners know how to apply what they have learned such as methods and skill. In body-moving learning group, learners can control the projectile initial speed by swing their hands at different speed. When they want to have a high projectile initial speed, they need to swing their hand quickly. On the other hand, learners in the finger-touching learning group just move their finger to control the projectile initial speed which is only related to the finger position, not to the speed. Therefore, hypothesis 1 is proposed as *"In fundamental projectile motion learning, the body-moving learning group has higher scores on the factual knowledge test than the finger-touching learning group"*.

During the learning period, learners in the body-moving learning group can interact with the game objects in the learning system through their body movements. But learners in the finger-touching learning group can only interact with the game objects by moving their finger to different positions and touching the screen for confirmation. The body-moving learning group has external perception for knowledge construction than the finger-touching learning group. The body-moving learning group provides learners a learning context capable of interacting with the game objects and adjusting corresponding parameters through their body movements. Although learners in the finger-touching learning group can also interact with the game objects and adjust related parameters, the connection between knowledge and motor skill is not strong enough. Thus, hypothesis 2 is proposed as *"In fundamental projectile motion learning, the body-moving learning group has higher scores on the procedural knowledge test in terms of projectile initial speed, angle, and motor skill than the finger-touching learning group"*.

A total of 60 elementary school students from grades four to six were recruited to participate in this experiment at National Science and Technology Museum, Taiwan. 30 of the participants are male. The average age is 10.82 with 0.93 standard deviation. Participations were randomly and equally divided into the body-moving learning group and the finger-touching learning group followed by the

same instruction of fundamental projectile motion. After the experiment, every participations can get a gift as rewards.

The design of the tests of factual knowledge and procedural knowledge is based on the definitions of the structure of the knowledge dimension (Krathwohl, 2002). Factual knowledge was assessed by selecting related terms from eight keywords including sunshine, parabola, force, angle, speed, temperature, water, and weather. After the experiment, the participants have to answer what the keywords related to the learning of fundamental projectile motion.

The test of procedural knowledge includes the projectile methods and the motor skill to project an object to correct places. The projectile methods were assessed by a projectile motion simulation program from PhET (<http://phet.colorado.edu>) including projectile angle and projectile initial speed. The simulation program has been widely used in the educational field. The participants were asked to finish two parts. First part is to fix projectile angle, and the participations only change the value of projectile initial speed to make the object hit the target. Second part is to fix projectile initial speed, and the participants only change the value of projectile angle to make the object hit the target. The total scores for each part is 10. Each learner in each part is allowed to have ten tries. When the learner fails a try, the scores will be deducted one point and the worst case is zero. A screenshot of this test is shown in Figure 3(a).

In the evaluation of the motor skill, learners have to throw a ball and sees if they can hit the scoring area in real world (Figure 3(b)). Firstly, participations should stand on the starting point. The throwing gesture in the motor skill is requested to be identical with that in the gamification activity. This test has two part including near-end and far-end. The total score in each part is three points. A learner has two opportunities in each part for practicing and three tries for counting scores. In each part, there are five blocks, one for ten points, two for five points, and two for one point. If a learner throws the ball out of the five blocks, the learner only gets one point.

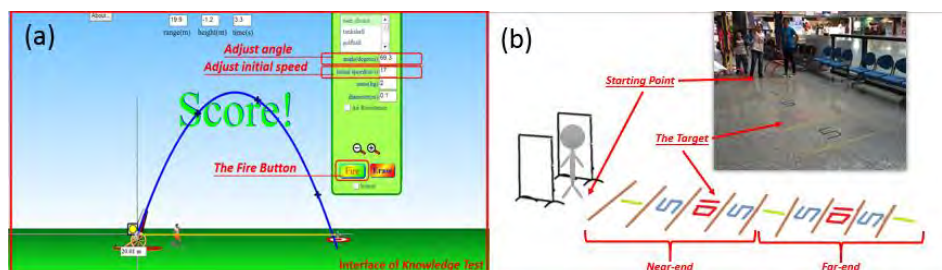

Figure 3. Procedural knowledge test (a) projectile initial speed and angle; (b) motor skill

Before the experiment, an instructor introduced the entire process to participants. At the beginning, a pre-test of procedural knowledge was conducted for five minutes. Then participants were randomly and equally divided into body-moving learning group and finger-touching learning group. Then, the learners in each group received corresponding instruction regarding the knowledge of fundamental projectile motion and the operation of the learning system for five minutes. In terms of learning system operation, each participant watched a demonstration of an instructor and had two opportunities to practice in person. Then, each participant started to perform the gamification activity for seven minutes. After the learning activity, a post-test of procedural knowledge was conducted for five minutes and the factual knowledge test was performed in two minutes. The pre-test and post-test of procedural knowledge is mostly the same only with different default parameters to avoid memorization effect. At the end of experiment, participants were requested to fill out a questionnaire in two minutes for collecting demographic data.

4 Results and Discussion

The descriptive statistic of the factual knowledge shows that most of participants chosen four keywords, namely parabola, force, angle, and speed. For hypothesis 1, an independent-sample t-test was used to test the difference between the body-moving learning group and the finger-touching learning group. This result shows that the body-moving learning group has better outcome in terms of speed than the finger-touching learning group ($t = 2.918, p < 0.01$). No significant difference was found in the other

seven keywords. The participants in the body-moving learning group have to swing their hand to control the projectile initial speed. The projectile initial speed reflects on how quick the learners swing their hand. Therefore, the learners can have a strong impression on speed. On the other hand, the learners in the finger-touching learning group just move their finger on the screen of the tablet PC and no related external clues can make their thinking associated with speed.

For hypothesis 2, this study used independent-sample t-test to test the difference between the body-moving learning group and the finger-touching learning group. No significant differences were found in the result of the pre-test which suggests that all participants in this experiment do not have significant differences of procedural knowledge in terms of projectile angle, projectile initial speed, and motor skill. The result of the post-test is shown in Table 1. The body-moving learning group has significantly higher scores of projectile angle than the finger-touching learning group ($t = 2.189, p < 0.05$). No significant differences were found in terms of the projectile initial speed and the motor skill.

Table 1: Independent-sample t-test result of procedural knowledge.

Type	Body-moving learning group (N=30)	Finger-touching learning group (N=30)	$t(p)$
	Mean (SD)	Mean (SD)	
Projectile angle	7.33 (1.688)	6.37 (1.732)	2.189* (0.033)
Projectile initial speed	7.37 (1.629)	7.73 (1.413)	-0.931 (0.356)
Motor skill	44.80 (9.925)	44.63 (7.712)	0.073 (0.942)

* $p < 0.05$

The result of procedural knowledge does not fully consist with the hypothesis 2. Two probable explanations are addressed in this study. The first one is that the design of the Angry Birds game which only emphasizes the adjustment of the projectile angle, not the adjustment of both projectile angle and projectile initial speed. The body-moving learning system can reflect the speed of swing a hand on the projectile initial speed in the game. By reviewing the video recording, most of the learners in the body-moving learning group would rather swing their hand at high speed than at low speed. The same situation also occurred in the finger-touching learning group. Therefore, it may affect the result of the procedural knowledge. The other explanation is that the elementary school student is too young to have an adult-like mature cognitive development. The embodiment-based design can facilitate learners to link body movements with the game objects and parameters. However, the young learners have difficulty to transform such experience from what they learned into real practices and applications because the gamification activity was performed in a third-person view. The motor skill was assessed in a first-person view. Thus, the young learners could not deal with the change of viewpoints well, and the outcome of motor skill is likely to be interfered.

5 Conclusion

This study exploits the Angry Birds game to provide elementary students gamification activities and improve their learning of fundamental projectile motion through an embodied approach. According to the results, the body-moving learning group outperformed the finger-touching learning group on speed in factual knowledge test and projectile angle in procedure knowledge test. These results have already shed light on the potential of gamification activities to learn factual knowledge and procedure knowledge of subjects. Although not all test items are significant, the learners in the body-moving learning group certainly obtain improvements on speed in factual knowledge and projectile angle in procedure knowledge. This study designs the gamification activities which can be accomplished in just seven minutes. Short period gamification activities are fairly appropriate for learning in field trips such as a part of educational exercises in a museum. Because the cognitive development of young learners is still in progress, the gaming experience can motivate them and learning by doing is also one good practice for digital game enhanced learning. One research limitation in this study is the fixed third-person viewpoint of playing the game because the off-the-shelf commercial game was used. Although the body-moving learning can link body movements with the game objects and parameters, the learning outcomes would be affected by the extent of learners' cognitive development. Instructors and

researchers have to take care of the issue of viewpoint changes for young learners when designing an embodiment-based learning system.

Acknowledgements

This research was supported by Ministry of Science and Technology and National Science Council in Taiwan under project numbers MOST 103-2511-S-110-002-MY3, NSC 102-2911-I-110-501, NSC 101-2511-S-110-003-MY3, and NSC 100-2511-S-110-001-MY3.

References

- Anastopoulou, S., Sharples, M., & Baber, C. (2011). An evaluation of multimodal interactions with technology while learning science concepts. *British Journal of Educational Technology*, 42(2), 266-290. doi: 10.1111/j.1467-8535.2009.01017.x
- Annetta, L., Lamb, R., Minogue, J., Folta, E., Holmes, S., Vallett, D., & Cheng, R. (2014). Safe science classrooms: Teacher training through serious educational games. *Information Sciences*, 264(20), 61-74. doi: 10.1016/j.ins.2013.10.028
- Arjoranta, J. (2013). *Understanding player interpretation: An embodied approach*. Paper presented at the 7th International Conference on the Philosophy of Computer Games, Bergen, Norway.
- Barsalou, L. W. (2008). Grounded cognition. *Annual Review of Psychology*, 59, 617-645. doi: 10.1146/annurev.psych.59.103006.093639
- Barsalou, L. W. (2010). Grounded cognition: Past, present, and future. *Topics in Cognitive Science*, 2(4), 716-724. doi: 10.1111/j.1756-8765.2010.01115.x
- Cagiltay, N. E. (2007). Teaching software engineering by means of computer-game development: Challenges and opportunities. *British Journal of Educational Technology*, 38(3), 405-415. doi: 10.1111/j.1467-8535.2007.00705.x
- Chao, K.-J., Huang, H.-W., Fang, W.-C., & Chen, N.-S. (2013). Embodied play to learn: Exploring Kinect-facilitated memory performance. *British Journal of Educational Technology*, 44(5), E151-E155. doi: 10.1111/bjet.12018
- Hao, Y., Hong, J.-C., Jong, J.-T., Hwang, M.-Y., Su, C.-Y., & Yang, J.-S. (2010). Non-native Chinese language learners' attitudes towards online vision-based motion games. *British Journal of Educational Technology*, 41(6), 1043-1053. doi: 10.1111/j.1467-8535.2009.01050.x
- Howison, M., Trninic, D., Reinholz, D., & Abrahamson, D. (2011). The mathematical imagery trainer-from embodied interaction to conceptual learning. In G. Fitzpatrick, C. Gutwin, B. Begole, W. A. Kellogg & D. Tan (Eds.), *Proceedings of ACM Conference on Human Factors in Computing Systems (CHI 2011)* (pp. 1989-1998). Vancouver, Canada: Association for Computing Machinery, ACM.
- Hung, I.-C., Lin, L.-I., Fang, W.-C., & Chen, N.-S. (2014). Learning with the Body: An Embodiment-Based Learning Strategy Enhances Performance of Comprehending Fundamental Optics. *Interacting with Computers*, 26(4), 360-371. doi: 10.1093/iwc/iwu011
- Krathwohl, D. R. (2002). Revision of Bloom's taxonomy: An overview. *Theory Into Practice*, 41(4), 212-218.
- Kuo, F.-R., Hsu, C.-C., Fang, W.-C., & Chen, N.-S. (2014). The effects of Embodiment-based TPR approach on student English vocabulary learning achievement, retention and acceptance. *Journal of King Saud University - Computer and Information Sciences*, 26(1, Supplement), 63-70. doi: 10.1016/j.jksuci.2013.10.003
- Lankoski, P., & Järvelä, S. (2012). An embodied cognition approach for understanding role-playing. *International Journal of Role-Playing*, 3, 18-32.
- Macedonia, M., Müller, K., & Friederici, A. D. (2011). The impact of iconic gestures on foreign language word learning and its neural substrate. *Human Brain Mapping*, 32(6), 982-998. doi: 10.1002/hbm.21084
- Martha W. Alibali, & Nathan, M. J. (2012). Embodiment in Mathematics Teaching and Learning Evidence From Learners' and Teachers' Gestures *The Journal of the Learning Sciences*, 21(2), 247-286. doi: 10.1080/10508406.2011.611446
- Rambusch, J. (2006). *The embodied and situated nature of computer game play*. Paper presented at the workshop on the cognitive science of games and game play, Vancouver, Canada.
- Shapiro, L. (Ed.). (2014). *The Routledge Handbook of Embodied Cognition*. London: Routledge.
- Sung, H.-Y., & Hwang, G.-J. (2013). A collaborative game-based learning approach to improving students' learning performance in science courses. *Computers & Education*, 63, 43-51. doi: 10.1016/j.compedu.2012.11.019
- Tüzün, H., Yılmaz-Soylu, M., Karakuş, T., İnal, Y., & Kızılkaya, G. (2009). The effects of computer games on primary school students' achievement and motivation in geography learning. *Computers & Education*, 52(1), 68-77. doi: doi:10.1016/j.compedu.2008.06.008

SHIVA: Virtual Sculpting and 3D Printing for Disabled Children

Leigh MCLOUGHLIN^{a*}, Oleg FRYAZINOV^a, Mark MOSELEY^b, Mathieu SANCHEZ^a,
Valery ADZHIEV^a, Peter COMNINOS^a & Alexander PASKO^a

^aNCCA, Bournemouth University, UK

^bVictoria Education Centre, UK

*lmcloughlin@bournemouth.ac.uk

Abstract: In this paper we present the SHIVA project which was designed to provide virtual sculpting tools for children with complex disabilities, to allow them to engage with artistic and creative activities that they might otherwise never be able to access. Modern 3D printing then allows us to physically build their creations. To achieve this, we combined our expertise in education, accessible technology, user interfaces and geometric modelling. We built a generic accessible graphical user interface (GUI), a suitable geometric modelling system and used these to produce two prototype modelling systems. These tools were deployed in a school for students with disabilities and are being used for a variety of educational purposes. In this paper, we present the project's motivations, approach and implementation details together with initial results, including 3D printed objects designed by children with disabilities.

Keywords: Virtual Sculpting, Accessibility, User Interfaces, Disabilities, 3D Printing

1. Introduction

Artistic activities are an important educational subject in their own right and can also provide strong links with other core subjects and life-skills such as spatial awareness, object recognition, as well as aspects such as self-expression and building self-confidence (Rubin, 2001). However, using clay or other sculpting materials is non-trivial for individuals with complex disabilities, as well as raising practical issues such as hygiene, dust, equipment, storage, and so on. In the SHIVA (Sculpture for Health-care: Interaction and Virtual Art in 3D) project, we proposed to use ICT to extend access to artistic tools within a fully protected environment, for vulnerable groups: people in rehabilitation (through French partners in Lille and the HOPALE Foundation) and children with various types of disabilities (by the authors in the UK at Bournemouth University (BU) and Victoria Education Centre (VEC)). In this paper we present the motivations, approach and initial results of the SHIVA project's use with children.

Young people with disabilities may have a very different experience of the physical world to those without (Tumbull, 2011). This experience may be influenced by their range of movement, coarse or fine motor control, or having spent their life in a wheelchair. New technologies are helping to provide ways in which young people who have disabilities can have the experience of the physical world in a virtual sense. Thus, the aim of the SHIVA project was to enable such young people to learn about manipulating objects by providing a few basic virtual sculpting tools and then producing the objects physically with 3D printing technologies.

The primary goals for the project were to give school students the opportunity to be creative and to produce physical artefacts which would otherwise not be possible for them by developing software tools. Artistic creativity was chosen for its well documented educational applications and benefits (Rubin, 2001) and the geometric modelling approach has similar parallels to the concepts of active learning and constructivism. So, the primary research objectives were: 1) to establish the ranges of interface requirements needed by children with disabilities; 2) to develop a generic accessible user interface system to meet these requirements and 3) to develop appropriate virtual sculpting methods, built on an accessible interface, and allowing 3D printing for real-world output.

2. Previous Work

2.1 User Models and Accessible User Interfaces

User interfaces provide the software interface layer between the human user and the actual software application. Most computers currently support user input from keyboard, mouse, touchscreen and to some extent voice commands while most output modalities rely on information-rich visual displays, which can be difficult for the visually impaired. While some of the project's students can use a mouse or touchscreen, others struggle to press a single large button, or have absolutely no limb control and can only access software through an eye-gaze system.

Each individual user with disabilities has very different interface requirements which vary according to their physical or cognitive abilities and which are dynamic and liable to change, often throughout each day. The interface must store information about its users in order to be configured to their requirements. This is called a user model and can generally be stored in two ways: a medical approach, where information about the user's medical and physical capabilities is stored; and a functional approach, where the user's interface requirements are stored. The medical approach must always be interpreted by the system to translate this into actual needs of the user.

Specialist accessible interface toolkits are available to extend the limited interface adjustments available in operating systems. The Grid 2 (Sensory Software 2014) provides disabled access primarily for communication. The software covers a wide range of inputs and features, but is not open or flexible enough for a heavy-weight application such as interactive 3D modelling. The MyUI project (Peissner et al, 2012) has an adaptive interface but is targeted at elderly people for giving them access to simple utilities and consumables. The user profile is adjusted while the user is working with the system, however the actual input of profile data is not supported. Similarly, the GUIDE project (Jung et al, 2012) has a user-centred approach to create basic UIs with a large variety of input devices as well as accessibility options, but again, the project is primarily focussed on elderly users for simplifying access to entertainment and communication and the user profile which is set up by guiding the user through a simple test is somewhat limited and does not take into account input of the user data nor complex disabilities.

SHIVA was designed to build on such work for setting up the user profiles, but extending the concepts to provide more flexibility and support for heavy-weight content creation tools rather than just media consumption.

2.2 Virtual Sculpting for Disabled Users

Virtual (Digital) Sculpting is a computer-aided technology allowing for the creation of sculptural artefacts. It can be performed in various ways: using 2D/3D input with subsequent reconstruction, using a purely mathematical description, using an interactive modelling technique that employs pressure-sensitive or haptic interactions, or alternatively, using a set of virtual reality interface tools such as cybergloves or Digital Clay.

The concept of Virtual Clay (McDonnell et al, 2001) is perhaps the most natural metaphor for virtual sculpting. It is supported by a number of commercial and research products such as Geomagic Freeform and Claytools, Cubify Sculpt, Pixologic's ZBrush and Sculptris.

Interactive local modifications can also be performed using different sculpting metaphors. In the Augmented Sculpture Project by the SHIVA team (Adzhiev et al, 2005) a specific interactive environment with embedded sculptural means was created. The user experiences an immersion into a virtual space where they can generate new shapes using either metamorphosis between several predefined sculpture models or the virtual carving tool with such operations as subtraction, offsetting and blending. Finally the resulting sculpting artefacts were 3D-printed to produce new physical sculptures. The project had both artistic and educational merits and the tools and lessons learned fed directly into the SHIVA project, especially the use of the group's scalar field or Function Representation (FRep) based modelling system due to its feature set and natural 3D printing suitability.

3. Approach

3.1 Accessible Graphical User Interface (GUI)

To achieve the objectives of the SHIVA project a new accessible interface was needed which could cater for the broad interface requirements of users with complex disabilities. A functional user modelling approach was determined the most suitable because it directly maps the user's interface needs with the software settings. The input mode and specific settings are stored in a user profile which is created for each individual student and which can also be transferred between different software prototypes that use the interface.

The user's physical needs were identified in a way that focussed on the direct interface requirements and their ranges. This informed the development of a generic graphical user interface (GUI) system to map all sculpting features to on-screen 'buttons'. All interface devices and modalities could then be successfully employed. Single button access is possible with switch-scanning (Colven & Judge 2006), where each GUI button is highlighted in turn until the user presses their switch to select the current element. This approach gives full access, regardless of physical input requirements.

The final SHIVA GUI system features include: switch-scanning with adjustable timing, direct progression with multiple switches; mouse or touchscreen control; button debouncing; key-mapping with activation on trailing or leading edges; basic eye-gaze support with adjustable dwell time and configurable rest zones; fully configurable GUI layouts which can be saved and loaded from user profile; visual styling across multiple profiles; visual adjustment in themes and profiles; configurable graphics for buttons, symbols, text, including sophisticated colour replacement in graphics.

3.2 Shape Modelling System Core

The third research objective was to allow the users to sculpt virtual objects and in our system we use a geometric representation in implicit form through Function Representation (Pasko et al, 1995). This allows us to describe a vast number of geometric primitives and perform many operations in a simple and efficient way compared to other traditional representations, such as polygonal meshes. Easy formulation allows us to work with traditional geometric primitives such as a sphere, box and cylinder. Beyond this, more complex geometric primitives such as polygonal meshes can be represented efficiently in the form of signed distance fields (Sanchez et al, 2012) which is a natural subset of Function Representation. Traditionally, the disadvantage of such a representation is that the geometry cannot be rendered using the standard interface for graphics hardware. In our system we visualise objects with real-time ray-casting on graphics hardware (Fryazinov and Pasko 2008).

The objects and operations are represented in the form of a tree that generates the defining function for the model. In the leaves of such a tree we have the geometric primitives and objects, while in the nodes we have operations over other nodes and leaves (Pasko et al, 1995). This allows us to perform operations in the modelling system by modifying the structure of the tree itself by adding and removing nodes.

As an intermediate format for the geometry we are using the volumetric object format developed by the Norwegian company Uformia. This supports most of the operations and primitives existing in the current state of the art in modelling with geometry represented in an implicit form. For 3D printing we must convert to a polygonal mesh.

4. Applications

4.1 Metamorphosis Prototype

The first prototype software developed by BU in collaboration with VEC and using the accessible GUI was a metamorphosis exercise, specifically for younger or less cognitively able students. Here, the user chooses two objects and can produce an intermediate shape that is a blend between the two objects. Interaction for this is through a slider and the blended shape is displayed to the user and

updated interactively. The user can then rotate their object and apply a colour to it. The relatively simplistic interface is shown in Figure 1.

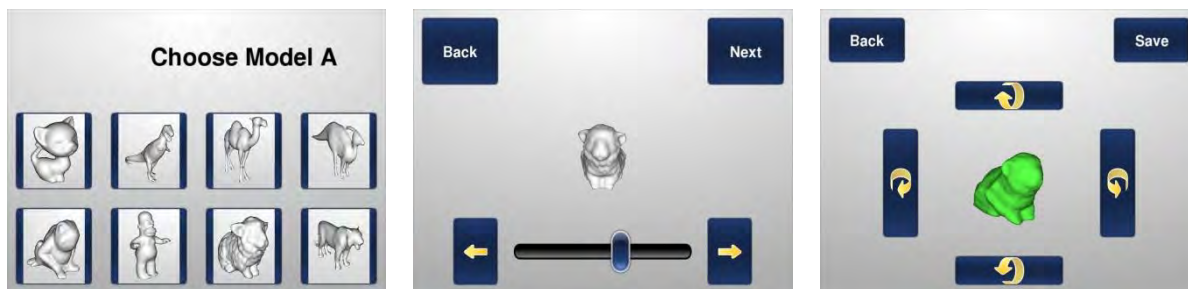

Figure 1. The metamorphosis prototype, with button layouts designed with VEC participation. The student chooses two models, can make a blend between them, and then colour the resulting shape. A blend between a sheep and a frog model is shown.

From the geometric point of view, in the application we perform metamorphosis operations over two FRep objects which can be seen as a linear interpolation between the values of the scalar field for the initial object and the target object, and we have tried more complex metamorphosis operations (Sanchez et al 2013). We used polygonal meshes of existing real-world objects converted to scalar fields as sources for the input shapes. The output of the application is the solid object representing the intermediate stage of the metamorphosis between two objects. The resulting object is a solid model and can be used for fabrication (3D printing).

4.2 Totem Prototype



Figure 2. The totem-pole prototype interface. Left: main construction screen with buttons to add primitive geometric shapes to the stack, navigation buttons and a designed shape showing primitive stacking, blending and drilling. Right: drill operation screen with cross-hair controls for drill location and controls to rotate the object.

The second software prototype from BU was a 'totem-pole' exercise, which provides a more complex sculpting environment. Here, the user stacks a small number of objects together and then performs simple modelling operations such as affine transformations on individual objects within the stack, or operations such as blending and drilling on the entire stack. For this application the accessible UI is necessarily more advanced (Figure 2). We currently allow the user to choose from a number of simple geometric shapes as an input: sphere, box, cylinder and cone. The set of operations over these objects include: Boolean operations (union, and subtraction), smooth union blending between objects, and affine transformations. From the implementation point of view the operations are achieved by modifying the tree representing the object.

5. Results



Figure 3. Designs by children with disabilities, produced using the SHIVA totem-pole exercise and printed at the Victoria Education Centre on a BFB 3D printer. The children used largely touch-screen interaction or eye-gaze tracking.

Some students were invited to try the software during the development phase in 2013. This was introduced to them in a careful and controlled manner because their reaction to potentially unstable prototype software was unknown. In reality, the students were extremely enthusiastic and took particular delight in the discovery of software bugs which was useful to the development team and gave the students a sense of value in their participation. Overall student engagement has been exceptionally high, with all participating students showing a great deal of enthusiasm. The software prototypes were installed at VEC and used by eleven students including two eye-gaze users. Students successfully produced a range of objects (Figure 3), validating the software and the process.

The SHIVA software has been successfully used to help teach students about spatial relationships between objects and general spatial awareness, including concepts such as 'up' and 'down', 'behind', 'rotate' and so on. This has also been useful to check comprehension and helped to identify two eye-gaze users who had similar difficulties with the concept of a 'stack' of objects. Teachers used a physical stack of objects and asked the users to reproduce the stack using the software. In the SHIVA Totem software objects are added in a stack which starts from the bottom, adding one object on top of the other. However, both eye-gaze users would consistently try to start the stack from the topmost shape first. It is unclear if their approach was a result of the way the task was presented to the students, but we hypothesise that because these users have simply never had the experience of physically placing one object upon another, the concept was quite new to them. Regardless of the causes, the identification of this has helped the teachers in their understanding of which fundamental spatial concepts need to be taught and reinforced with such students.

The software is used to help students understand how the shape of an object may be constructed from a set of simple primitive shapes and understanding the differences between and representations of 2D and 3D shapes. One popular teaching exercise is for the student to reproduce a drawn shape using the SHIVA software. Emphasis is placed on enjoying the experience rather than producing a 'correct' result and some students have already shown progress – one student who started with creating random objects is now creating identifiable objects such as a cat or a teddy-bear.

Speech therapists at VEC have successfully used the software with students in their regular activities to help with speaking and listening and cognitive development by working on concepts of sequencing, following instructions, communicating ideas and collaborative work. Early observations suggest the students' enthusiasm for the software will lead to good results.

The SHIVA software is now being used in regular scheduled art lessons at VEC. A 'shoe-box landscape' project inspired by the work of British sculptor Andy Goldsworthy involves students creating sculptural arches as viewing windows similar to some of his famous works.

Therapists are also starting to use the software as a tool from the point of view of an aid in improving manual dexterity, or through a touch-screen interface to gradually encourage students to increase their range of movement by allowing them to reach for more distant input controls.

6. Conclusions and Future Work

In this paper we presented the SHIVA project, which was designed to allow disabled children to produce virtual sculptures and then use 3D printing technologies to fabricate these. To achieve this, we established research questions to identify and address interface requirements and to identify and develop appropriate virtual sculpting.

The interface requirements were identified and described with a functional user model, resulting in user profiles that stored each individual's interface settings for a new purpose-built GUI system. We coupled this with a Function Representation (FRep) modelling system to develop two prototype software applications aimed at different cognitive levels, which gave virtual sculpting capabilities to users with disabilities through the accessible GUI.

While formal user-studies and longer term developmental studies will be useful to quantitatively identify any educational benefits, from the perspective of the school simply giving a child with no limb control the ability to create a physical sculpture for the first time in their life is a far more powerful incentive and one where the real emotional and motivational benefits are far greater yet not as easy to measure.

Moving forwards for future work, the SHIVA software prototypes provided a small subset of modelling features. A more flexible system would be desired for more advanced users including adults. The SHIVA GUI represented a state-of-the-art prototype system, but a number of open questions remain, including: lower requirement on technical staff for profile creation; automatic user adaptation; support for further input modalities: brain computer interface, gesture, multi-touch, tablet; and flexible input mapping from multiple modalities. The inclusion of all these aspects would allow the software to be used by individuals with a broader range of disabilities and would make setting up and maintaining the software easier.

Acknowledgements

We would like to thank the staff and students of Victoria Education Centre for their support of this project. The SHIVA project was funded by the EU INTERREG IV Two-Seas Programme.

References

- Adzhiev V., Comninos P., Kazakov M. & Pasko A. (2005) Functionally based augmented sculpting. *Journal of Visualization and Computer Animation*, 16(1), 25-39
- Colven D. & Judge S., (2006) Switch Access to Technology, ACE Centre Advisory Trust, Oxford, UK.
- Fryazinov O. & Pasko A. (2008) Interactive ray shading of FRep objects. In: *WSCG' 2008, Communications Papers proceedings* (pp. 145-152), Plzen - Bory, Czech Republic.
- Jung C., Hamisu P., Duarte C., Biswas P. & Almeida L. (2012) GUIDE: Personalisable Multi-modal User modal User Interfaces for Web Applications on TV Interfaces, *Proceedings of NEM Summit 2012*
- McDonnell K. T., Qin H., & Wlodarczyk R. A. (2001) Virtual clay: a real-time sculpting system with kaptic toolkits, *Symposium on Interactive 3D Graphics*, ACM, 2001, pp. 179-290.
- Pasko A., Adzhiev V., Sourin A., & Savchenko V. (1995) Function representation in geometric modeling: concepts, implementation and applications. *The Visual Computer* 11(8), 429-446
- Peissner M., Häbe D., Janssen D. & Sellner T. (2012) MyUI: Generating accessible user interfaces from multimodal design patterns. In: *Proceedings of the 4th ACM SIGCHI Symposium on Engineering Interactive Computing Systems EICS '12* (pp 81-90), Copenhagen, Denmark: ACM Press.
- Rubin J.A. (2001) Approaches to Art Therapy, Theory & Technique. Routledge, Taylor & Francis Group.
- Sanchez M., Fryazinov O., & Pasko A. (2012) Efficient evaluation of continuous signed distance to a polygonal mesh. In: *Proceedings of SCCG 2012* (pp. 101-108)
- Sanchez M., Fryazinov O., Vilbrandt T., & Pasko A. (2013) Morphological shape generation through user-controlled group metamorphosis. *Computers & Graphics* 37(6): 620-627
- Sensory Software (2014) The Grid 2, communication aid software <http://sensorysoftware.com/grid-software-for-aac/>
- Turnbull A., Turnbull R.H., Wehmeyer M. L., Shogren K.A. (2011) Exceptional Lives: Special Education in Today's Schools. Pearson, USA.

Inferred Learning Strategy in Two-User-One-Computer Environment Study from Cognitive Style Perspective

Jo-Yu HUANG^{a*}, Ben CHANG^a, Yi-Jie LIN^b & Fang-Chen LU^a

^aGraduate Institute of Learning and Instruction, National Central University, Taiwan

^bDepartment of E-learning Design and Management, National Chiayi University, Taiwan

*traci9034@gmail.com

Abstract: Prediction-observation-explanation (POE) inquiry approach has been proven as a useful approach in helping students to inquire and to understand the subject deeply. Computer has demonstrated its power on simulation which can simulate a lot of environment. Combining the POE model and the computer simulation power, the authors propose an extended model named PSOE which represents prediction-simulation-observation-explanation model. A simulation APP game, “Newton’s Miracle,” was implemented to test the PSOE model. To explore the APP game usability on different cognitive styles students, an experiment was conducted in which fifty-six 8th grade students were involved. The experimental results indicate that the students’ learning achievement has improved, and the field independent and the low achievement students perceive more learning achievement from the APP game.

Keywords: Prediction, inquiry-based learning, game-based learning, cognitive styles

1. Introduction

In mobile devices supported classroom design, a straightforward thought is to equip each kid with one mobile device. However, classrooms are the place where students have their peers to interact with. We will argue that letting two students to share one computer can help to enhance their interaction, and to attract their discussion and understand on the learning subject. In this study, the authors adopt two-user-one-computer design approach which means two students use one computer face-to-face together to design a PSOE (prediction-simulation-observation-explanation) game. PSOE is extended from POE (prediction-observation-explanation) model (Hong, Hwang, Liu, Ho and Chen, 2014). In the PSOE environment, one of the paired students firstly proposes a question, the other student predicts the result consequently. Once both of them agree the proposed question and the proposed prediction result, the computer then simulate the results to test the proposed prediction result. The students then compare the differences among the prediction and the simulation results and give a reasonable explanation. To exam the PSOE concept mentioned above, the authors implemented a two-user-one-computer simulation APP game named “Newton’s Miracle.” Besides, to study the system more systemically, the field dependent (FD) and field independent (FI) cognitive styles were considered to investigate different cognitive styles students’ responses on the “Newton’s Miracle” game. An experiment which involved fifty-six students was conducted to test the APP game. The results indicated that the game was helpful for the students to improve their subject understanding especially for the FI students and low achievement students.

2. Method

2.1 “Newton’s Miracle” System Introduction

In this study, the authors developed a two-user-one-computer simulation game named “Newton’s Miracle” which is an inferred learning strategy tablet APP game. The game is a paired game which

means two students play the game together. In the game, one of students plays the environment arrangement role setting the simulation environment, and the other one plays the prediction role predicting the simulation results. The subject of the game is Newton's Laws of Motion. As shown in Figure 1, at beginning of the game, one of the paired students sets the values including the power of the force, and the force angle on the ball. The other student then needs to predict the movement of the ball. After both of the students complete the parameters settings and the result prediction, a physical simulation software engine is used to simulate the settings, and simulates physical simulation result. The game then calculates the score in this turn. The more accuracy rate the prediction, the higher scores the participant win. After complete a round, the paired students exchange their roles and start next round until one participant's score is higher than 100. Students can directly understand the Newton's Laws of Motion through computer simulation.



Figure 1. Newton's Miracle System Screenshots.

2.2 Participants and Research Instrument

Fifty-six 8th grade students from a junior high school students in Taiwan took part in this study. Among them 27 were males and 29 were females. Due to taking into account the fairness, the homogenous grouping strategy was adopted in this study. More specifically, two students with a similar level of prior achievement and same cognitive styles were formed as a group according to the results of the measurement of cognitive styles and pre-test. The participants all had the basic knowledge about Newton's Laws of Motion and didn't have any experience about computer simulation course. The experimental procedure is composed of five steps. They are preliminary training, cognitive style measurement, pre-test, interactions with "Newton's Miracle" system, and post-test.

The preliminary study took five days and forty minutes per day. On the first day, the participants were initially trained to know how to play the "Newton's Miracle" game, involved to do cognitive style measurement and the pre-test of the Newton's Laws of Motion. The cognitive style dimension investigated in this study was the level of field dependence. The group Embedded Figures Test (GEFT) is used in the study (Witkin, Oltman, Raskin and Karp, 1971). The GEFT reliability ($\alpha=.82$) is properly and frequently utilized instrument to measure an individual's degree of field dependence (Hong, Hwang, Tam, Lai, & Liu, 2012). Two similar pre-test and post-test tests were designed by a junior high school science teacher who was familiar with Newton's Laws of Motion. The pre-test and post-test were common physical movement phenomenon of life based on Newton's Laws of Motion. The total score of the pre-test and post-test of the Newton's Laws of Motion was 100. Among the 56 participants, 16 were measured as FI and 22 as FD. We also classified students to high achievement group and low achievement group by the score of pre-test. Among the students, 18 were measured as high achievement and 20 as low achievement. To ensure the participants' correct use of the system, the researcher explained the operation of the system and demonstrated to them before they did the experiment. On the last day, after the experiment had finished, participant had post-test of Newton's Laws of Motion.

3. Preliminary Data Analysis

In this study, the independent variable was the cognitive styles (i.e. FI or FD). The dependent variables were the pre-test and post-test scores from the Newton's Laws of Motion tests. In addition to the pre-test

and post-test scores, another dependent variable was the gain score, which was obtained by finding the differences between the pre-test scores and post-test scores.

The paired t-tests were carried out to test whether significant differences exist between pre-test and post-test for the 56 participants. In learning achievement of Newton's Laws of Motion, the mean score of pre-test was 46.07 and the mean score of post-test was 55.54. The result of paired sample t-test suggested that the mean score of post-test was significantly high than the mean of pre-test ($t = -4.85$, $p < .05$). The results suggested that the participants' score had significant improvement after playing "Newton's Miracle" game. As shown in Table 1, there was a significant progress for the students. The preliminary findings indicated that the "Newton's Miracle" system was helpful for the students to learn Newton's Laws of Motion.

Table 1: Pair sample t-test of learning achievement.

Variable	M	N	S.D.	t	Sig.
Pre-test	46.07	56	15.57	-4.85*	.000
Post-test	55.54	56	17.93		

* $p < 0.5$

To further analyze the data, the differences of learning achievement and cognitive styles of participants were involved. The statistics of the results were listed in Table 2. The data indicates that all the participants had improvement in the subject, especially the FI students whoever they were high achievement or low achievement students. Besides, the low achievement students, in general, have a lot of improvement on the learning subject. This is a preliminary study. The reasons causing those effects still need further study.

Table2: Descriptive statistics analysis of learning achievement.

	Learning achievement	N	Pre-test	Post-test	Improvement
FD group	Low achievement	12	32.08	44.58	7.50
FD group	High achievement	10	56.00	60.00	4.00
FI group	Low achievement	8	40.00	59.38	19.38
FI group	High achievement	8	60.63	72.50	11.87

4. Conclusions and Discussion

In this study, based on POE model, an extended PSOE model which including prediction, simulation, observation and explanation learning activities was proposed. To test the PSOE model, a simulation game named "Newton's Miracle" was implemented. The subject of the system was Newton's Laws of Motion. In the system, two students can play the simulation game together face-to-face simultaneously. According to experiment results, the participants completed PSOE interactive learning activity showed that their scores had increased significantly. Meanwhile, the FI students and low achievement students had higher improvement than high achievement students. This is just a preliminary study. The system and the evaluation process still have a lot of room to improve.

References

- Hong, J. C., Hwang, M. Y., Liu, M. C., Ho, H. Y., & Chen, Y. L. (2014). Using a "prediction-observation-explanation" inquiry model to enhance student interest and intention to continue science learning predicted by their internet cognitive failure. *Computers & Education*, 72, 110-120.
- Hong, J. C., Hwang, M. Y., Tam, K. P., Lai, Y. H., & Liu, L. C. (2012). Effects of cognitive style on digital jigsaw puzzle performance: a GridWare analysis. *Computers in Human Behavior*, 28(3), 920-928.
- Witkin, H. A., Oltman, P. K., Raskin, E., & Karp, S. A. (1971). Role of the field-dependent and field-independent cognitive styles in academic evolution: a longitudinal study. *Journal of Educational Psychology*, 69(3), 197-211.

Can time perception be affected by interactive comics?

Xinwei Wang, Jun Hu, Bart Hengeveld & Matthias Rauterberg

Technical University of Eindhoven, Den Dolech 2.5612 AZ, The Netherlands
{x.wang, j.hu, b.j.hengeveld, g.w.m.rauterberg}@tue.nl

Abstract: In this paper, we describe our ongoing work towards understanding how interactive comics could affect time perception. An interactive comic story, *The Dreaming Wine*, has been created based on our current understanding of interactive comics, time perception and the relation between both. As a starting point for our research, we conducted an experiment on whether the amount of panels would affect the time perception of the comic reader. A list of principles was applied in splitting comic panels. The findings of the experiment are expected to provide a better understanding of how panels in interactive comics have an effect on the reader's time perception.

Keywords: Time perception, interactive comics, panel

1. Introduction

Time perception plays a crucial role in many aspects such as consciousness, memory of the past and future, and more (Grondin, 2010). These aspects are related to learning. In this paper we are interested in time perception, learning and the role interactive comics could play here, as one of the most important attributes of comics is sequentiality (Eisner, 1985; McCloud, 1993) which means it contains "time". We consider that there are at least four kinds of "time" in (interactive) comics: 1) real time in reality, 2) perception of the time in reality, 3) time in a story, and 4) perception of the time in the story.

Comics as a visual information and communication medium have been used in education and training related fields (Gordon, 2006; Mallia, 2007; Tatalovic, 2009). Comics are convenient for translating information into visual language at a relatively low cost. Along with the growing popularity of electronic devices, comics reading behavior migrates from paper-based to digital forms. Comics with designed interactivity can provide space for expression and reaching more engagement of the reader. However, research shows that people still prefer paper as a medium for reading, especially in-depth reading (Liu, 2005). Thus, how to design interactive comics to affect time perception in order to facilitate reading and learning is a relevant question for comic producers and educators.

2. Interactive Comics -- The Dreaming Wine

In order to study interactive comics, we created an interactive comic called *The Dreaming Wine*. Its story is adapted from an ancient Chinese legend recorded in "In Search of the Supernatural". The original story is about a man named LIU Xuanshi who got drunk by a strong wine called One Thousand Days Intoxication produced by a famous wine maker DI Xi. We found that this story contains valuable concepts of time. The reason why LIU got drunk for that long might be because he got lost in his own intoxicated illusion. Our main adaptation is that we added a "dream world" to the story to visually emphasize this illusion. By creating "the dream world", we create space for different time concepts and expressions. Comparing to the "the real world" in the story, "the dream world" contains unusual narrative time and visual expressions.

2.1 Story structure

The plot of the story contains mainly 3 parts: events in the “real world”, events in “the dream world” and events back to the “real world”. The finished comic story (Figure 1) contains 20 pages with 104 panels in black and white. See Table 1 for the page and panel distribution according to this plot:



Figure 1. Samples of the finished comic story.

	Events in the “real world”	Events in “the dream world”	Back to the “real world”
Page No.	1-5	6-13	14-20
Panel No.	001-025	026-068	069-104

Table 1: Page and panel distribution.

2.2 Experimenting with panels

There are several factors that can influence the reader’s time perception in reading interactive comics, such as panel arrangement, narrative and interactivity. Cohn (Cohn, 2013) divided comic strips into units, visualized as panels or combinations of panels. One of our assumptions is that the reader’s time perception can be affected by the amount of the panels in comics. To experiment with this assumption, we have created a second version of “The Dreaming Wine”, a variation of the first version with more panels, by splitting the original panels but keeping the same context as much as possible.

2.2.1 Panel splitting

According to McCloud (1993) one single comic panel can possess a period of time. This means time in a panel is divisible, as a period of time can be divided into smaller periods of time. Under the premise of maintaining the same narrative, the same amount of visual information and reading fluency, we tried to split the original comics with 104 panels into 173 panels, following these principles:

- Introduction, talking and thinking: can be split at possible transitions. (Figure 2A)
- Conversations inside a panel can be split at the turns. Chu et al. discussed how to optimize speech balloon according to number of words and emotion embedded in subtitles in their research of generating comics from videos (Chu & Yu, 2013). We adapted their conversation splitting methods in to this principle. See Figure 2B.
- Movements inside a panel can be split at the changes. See Figure 2C. Note: Onomatopoeia—visual words that indicates source of the sound. In comics, onomatopoeia usually happens when there is movement. Therefore, it can be seen as a sign of splitting.
- Silent moments: there are several panels that can be partially replicated to create silent moments. This kind of splitting is subjective and can be created either before or after the original panel. See Figure 2D.
- Exceptions: If the splitting influences clarity of image (mostly because the size of the original panel is already small), the panel shouldn’t be split. If there is conversation happening in introduction, to keep the introduction complete, the panel shouldn’t be split. See Figure 2E.

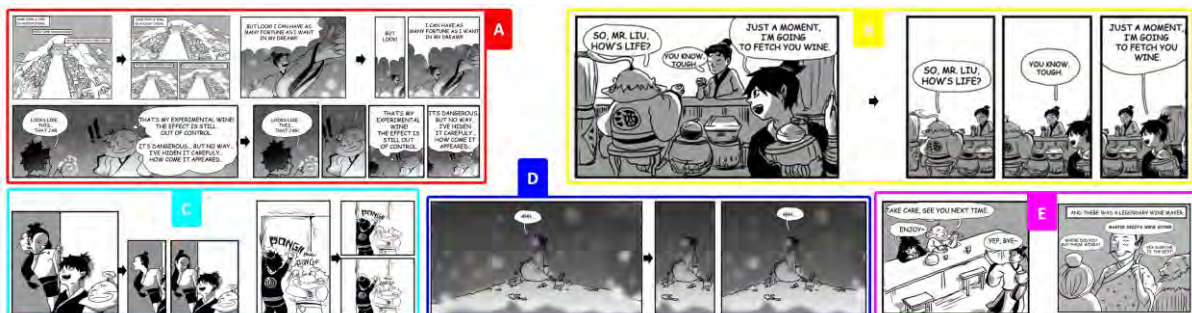

Figure 2. Panel splitting principles.

2.2.2 Experiment setting

We conducted a between-group experiment using the two variations of “The Dreaming Wine”. The

variable is the amount of panels. We used two versions of *The Dreaming Wine*: version A containing 104 panels, and version B containing 173 panels. The comic was shown on a tablet with limited interactivity, using a click left and right button on each side of the page to flip pages. Reading path and time spent on each page were recorded automatically, including flipping back. Each participant was invited to a quiet room (approximately 9 m²) with a table and chairs. In order to test time perception, each subject was asked to remove their watch and any other portable device that can tell time. Also, the visible clock on the experiment tablet was blocked. Each participant was informed about the basic information of the experiment, and asked to take time to read the comics to get the basic understanding of the story. In order to let participants get familiar with the experiment setting, they would interact with a three-pages training comic first. Then, each participant was asked to estimate 1 minute both before and after reading the formal comics, and also his/her estimation about how long he/she spent on reading. A questionnaire was used at the end of the experiment to check the participants' understanding of the story, and an interview (recorded on audio) was conducted focused on individual reading performance. The experiment was conducted during 9:30-11:30 and 14:30- 16:30 on workdays for two weeks with forty participants in total. We collected data including: total reading time, time spend on each page, reading path (whether there is a read back event), 1 minute estimation before and after reading, reading time estimation of the participant, and story (information) comprehension of the participant.

3. Discussion

We observed several facts that could be important for further research: 1) Reading back event happens often when switching from “the dream world” to “real world”; 2) Some people are more sensitive to verbal information while some are more to image information in the context of comics; 3) People tend to set up their own standing point based on time information shown in the comics to build a time line, the time information can be word and/or image that indicate time; 4) The influence of different amounts of panels is unclear, while time spent on each page does clearly differ. We will conduct further analysis combined with questionnaire and interview data. We believe that in order to study the effect of panels within interactive comics, not only time spent for each page but also time spent for each panel should be recorded, which could mean including eye-tracking in a follow-up experiment.

Acknowledgements

This research is supported by the Chinese Scholarship Council and facilitated by Eindhoven University of Technology.

References

- Chu, W.-T., & Yu, C.-H. (2013). Optimized speech balloon placement for automatic comics generation. In *Proceedings of the 3rd ACM international workshop on Interactive multimedia on mobile & portable devices* (pp. 1–6). ACM.
- Cohn, N. (2013). Visual narrative structure. *Cognitive Science*, 37, 413–52.
- Eisner, W. (1985). *Comics & sequential art*. Poorhouse Press Tamarac, FL.
- Gordon, A. S. (2006). Fourth frame forums: interactive comics for collaborative learning. In *Proceedings of the 14th annual ACM international conference on Multimedia* (pp. 69–72). ACM.
- Grondin, S. (2010). Timing and time perception : A review of recent behavioral and neuroscience findings, 72(3), 561–582.
- Liu, Z. (2005). Reading behavior in the digital environment: Changes in reading behavior over the past ten years. *Journal of Documentation*.
- Mallia, G. (2007). Learning from the sequence: The use of comics in instruction. *ImageText: Interdisciplinary Comics Studies*, 3(3).
- McCloud, S. (1993). *Understanding comics*. William Morrow Paperbacks.
- Tatalovic, M. (2009). Science comics as tools for science education and communication: a brief, exploratory study. *Jcom*, 8(4).

Subjective Evaluation of Stereoscopic View in Immersive Projection Display

Kikuo ASAI^{a*}

^a*The Open University of Japan, Japan*

*asai@ouj.ac.jp

Abstract: We made a subjective evaluation of stereoscopic views in an immersive projection display. This kind of display has been used for exhibiting virtual reality content in learning facilities such as science museums and cultural centers. They require space and time that differ from those in daily life. The immersive projection display may provide us with the sense of presence by stereoscopic images with a wide field of view. We performed an experiment to compare stereoscopic images with normal images in moving around in the virtual world. The results of the subjective evaluation suggested that the virtual objects placed near a user looked three dimensional more in the stereoscopic views, and the sense of presence was provided sufficiently even in the normal views.

Keywords: Immersive projection display, stereoscopic view, evaluation, virtual reality

1. Introduction

Since an immersive projection display has been proposed as a CAVE system (Cruz-Neira, Sandin, & DeFanti, 1993), many systems have been applied as a virtual reality environment to learning facilities such as science museums and cultural centers. The typical CAVE system consists of four screens with three sided walls and a floor forming a cubic screen. Stereoscopic images are projected to each screen so as to be seamlessly seen from a user's point of view, achieving a wide viewing angle. It enables the user to be given the sense of presence at a high level.

When new media are used for learning, the performance gains in the initial period of time (Clark, 1983). It is called the novelty effect. The novelty effect is convenient for learning environments such as science museums and cultural centers, because those environments are required to have space and time that differed from those in daily life (Bell, 2002). We believe that the immersive projection display has potential to provide the space and time that differ from those in daily life. It is not clarified what elements of the immersive projection display affect the user's experiences, though there have been the researches on effects of large displays (e.g., Tan, et al., 2006) and stereoscopic displays (e.g., Willemsen, 2008) on task performance. Here, we investigate the effects of stereoscopic views on the sense of presence by a subjective evaluation in an immersive projection display.

2. System

Our immersive projection display was originally constructed as a CAVE-like system with a 5.5-surface cubic screen (Asai, Osawa, & Sugimoto, 1999). It was reconstructed with a PC cluster and freely available software (Asai & Takase, 2013). Only four out of five surfaces in the cubic screen were used as the projection display, as shown in Figure 1 (a). Stereoscopic images are projected by LCD projectors, and are separated to the left-eye and right-eye images through the circular polarization. The size of each square screen is 3 m by 3 m, and the projection resolution is 1000 by 1000 pixels. The stereoscopic images are generated by four PCs equipped with a GPU, which form a PC cluster through a gigabit Ethernet LAN. A wired game pad is used as a joystick for controlling the viewpoint in the virtual world. We developed an original application of moving around in the virtual tideland and observing various kinds of wild birds in the different period of year, as shown in Figure 1 (b).

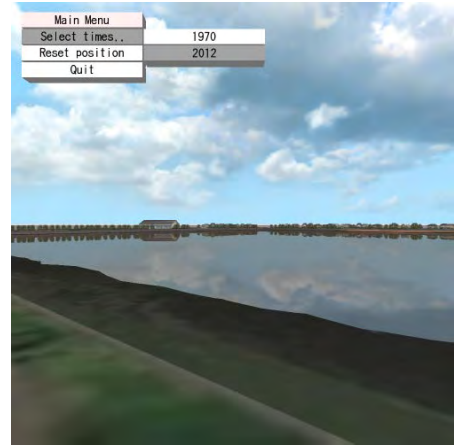

(a) Overview of immersive projection display (b) Screenshot of virtual tideland world
Figure 1. Presentation by immersive projection display.

3. Experiment

We performed an experiment to compare stereoscopic images with normal (two dimensional) images in viewing scenes of the virtual tideland world. Both stereoscopic and normal images were projected to the four screens (three walls and one floor), and no sound was generated during their experiences.

3.1 Methods

Nine participants were the BA and BS students who gathered from different universities. The participants used the system for roughly 5 minutes in each condition on the stereoscopic and normal views. They were instructed to move around in the virtual tideland world. They were polled with a preference test after the use. The preference test includes 9 questions listed in Table 1. A five-point Likert scale was used in the preference test, ranging from 1=definitely disagree to 5=definitely agree. Open-ended comments were required to provide their opinions in using the immersive projection display for viewing the virtual tideland world.

Table 1: Questions in preference test in experiment.

No.	Question items
1	The system responded smoothly.
2	The objects close to you looked three dimensional.
3	You distinguished the objects placed near and far.
4	The scenes were viewed with the depth feeling.
5	You were immersed in the virtual world.
6	Viewing scenes was interesting.
7	You felt something uncomfortable in viewing scenes.
8	It was suitable for viewing scenes for a long time.
9	You were tired in viewing scenes.

3.2 Results and Discussion

Results of the preference test are shown in Figure 2. The number in the horizontal axis corresponds to each question item, and the symbols a and b indicate the conditions of stereoscopic and normal views, respectively. The thin bar on each black and white column is the standard deviation. The results from a paired t-test obtained the tendency toward significant differences between the conditions in the question items 2 ($t(8)=2.95$, $p<0.05$), 3 ($t(8)=2.53$, $p<0.05$), 4 ($t(8)=3.16$, $p<0.05$), and 8 ($t(8)=-2.68$, $p<0.05$). The question no. 2 and 8 had large differences between the conditions in the average scores, and each

score differs largely between the participants. The question no. 3 and 4 had the significant differences between the conditions, but the scores stayed between 3 and 5 in the both conditions.

The result of the question no. 2 suggested that the objects close to him/her looked three dimensional more in the stereoscopic views than in the normal views, though it depended on the participants. The result of the question no. 8 suggested that the stereoscopic views were not so suitable for the long time use. We guessed that this result was influenced from the high speed of moving around in the virtual world, because four participants reported in the open-ended comments that they had a feeling similar to motion sickness due to the high speed movement. Although the tendency toward the significant differences was found in the question no. 3 and 4, the high scores in the both conditions may lead to the importance of the other parameters such as wide views, rather than the stereoscopic views. The high scores in the question no. 5 and 6 also suggest that the both stereoscopic and normal views have given the participants the immersive and enjoyable feelings that may bring learning effectiveness.

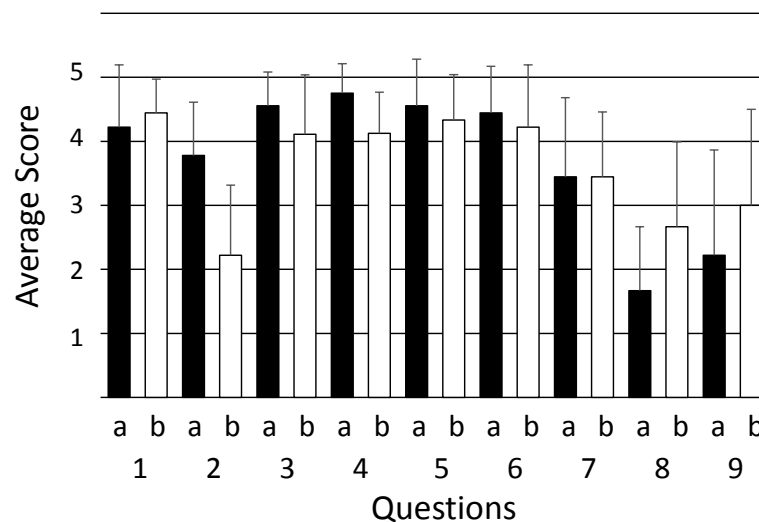

Figure 2. Results of preference test in experiment (a: stereoscopic, b: normal).

4. Summary

We made a subjective evaluation of stereoscopic views in an immersive projection display, comparing stereoscopic images with normal images in moving around in the virtual tideland world. The results of the subjective evaluation suggested that virtual objects placed near a user looked three dimensional more in the stereoscopic views, and the sense of presence was provided sufficiently even in the normal views.

References

- Cruz-Neira, C., Sandin, D. J., & DeFanti, T. A. (1993). Surround-screen projection-based virtual reality: the design and implementation of the CAVE, *Proc. ACM SIGGRAPH*, pp.135–142.
- Clark, R. C. (1983). Reconsidering research on learning from media. *Review of Educational Research*, vol.53, no.4, pp.445–459.
- Bell, G. (2002). Making sense of museums: the museum as ‘Cultural Ecology’. *IntellLabs*, pp.1–17.
- Tan, D. S., Gergle, D., Scupelli, P., and Pausch, R. (2006). Physically large display improve performance on spatial tasks. *ACM Transactions on Computer-Human Interactions*, vol.13, no.1, pp.71–99.
- Willemsen, P., Gooch, A., A., Thompson, W. B., and Creem-Regehr, S. H. (2008). Effects of stereo viewing conditions on distance perception in virtual environments. *Presence*, vol.17, no.1, pp.91–101.
- Asai, K., Osawa, N., & Sugimoto, Y. Y. (1999). Virtual environment system on distance education, *Proc. EUROMEDIA '99*, pp.242–246.
- Asai, K., & Takase, N. (2013). Reconstructing an immersive environment system with PC Cluster and freely available software, *Proc. International Workshop on Advanced Image Technologies (IWAIT)*, 6 pages.

Tangible Animal Companions in Traditional Chinese Character Learning

Zhi-Hong CHEN^{ac*}, Sheng-Chun WANG^a, Han-De LU^a, Chih-Yueh CHOU^{bc}

^a*Department of Information Communication, Yuan Ze University, Taiwan*

^b*Department of Computer Engineering and Science, Yuan Ze University, Taiwan*

^c*Innovation Center for Big Data and Digital Convergence, Yuan Ze University, Taiwan*

*zhchen@saturn.yzu.edu.tw

Abstract: With the advance of tangible technology, more and more educational systems are enhanced. This paper describes how tangible technology could enhance animal companions in terms of human computer interaction. These potential advantages are further organized as three design considerations, which further underpin the development of tangible animal companions. The tangible animal companions are also applied to the learning activity of traditional Chinese characters for young students. By doing so, tangible technology in learning can be evaluated and advanced in the future.

Keywords: Tangible technology in learning, animal companion, Chinese character

1. Introduction

With the emergence of the tangible technology— users use their hands to manipulate some physical objects, and a computer system detects this to give appropriate feedback (Ullmer & Ishii, 2001; Ishii & Ullmer, 1997), tangible technology in learning has been devoted more and more research efforts. This might be due to the fact that tangible technology might benefit learning in two ways.

First, tangible technology could enrich students' learning experience by combining multiple sensorial media. From the perspective of history, new technologies (e.g., Multimedia, Internet, Mobile devices) always drive new educational applications, in which students are more engaged or have more joyful learning experiences. Tangible technology emphasizes manipulating physical objects to learn, which can be further integrated with other multisensory approach (e.g., visual, auditory, kinesthetic, and tactile) and pedagogical strategies to benefit students' learning experience.

Second, tangible technology could advance students' thinking through learning-by-doing. From the perspective of tangible user interface, embodiment and metaphor are the two significant characteristics (Fishkin, 2004). The former means the tie relationship between input event (e.g., manipulation) and out event (e.g., feedback). For instance, the full embodiment means the entire state of the device is embodied within the system, which can focus students' attention. The latter refers to the comparison between the system effect and real-world effect performed by a user's action. For example, the full metaphor offers more affordances by physical shape, size, color, texture, or other features to invoke the metaphorical cues.

Previous studies have indicated that animal companions could enhance the human-computer interaction through developing emotional attachment with students (Chen, 2012). On the other hand, tangible technology has also been investigated to benefit students' interest and motivation. Along this line, tangible animal companions might maximize the effects of educational systems on student learning in different domain subjects. However, fewer studies investigate possible applications on different domain subjects. Thus, this study develops a tangible animal companion applied to the learning of traditional Chinese characters. Having this system, the influences of tangible animal companions system can be conducted in the future.

2. Tangible Animal Companion

2.1 Conceptual idea

The conceptual idea of tangible animal companion is underpinned by three design considerations: emotional attachment, learning companion, and tangible user interface. First of all, emotional attachment is regarded as one of the effective means to deepen the relationship between computers and students. For young students, their attachments to pets have been applied to enhance the interaction with educational agents (Chen, 2012). When students are more willing to care about their educational agents, the educational agents will have more chances to care about the system, which in turn drives the reciprocal caring and feedback between students and computers. Human-computer interaction is thus deepened and enhanced.

Next, learning companions are our design consideration from cognitive aspect. Learning companions refer to a pedagogical representation of virtual participants which learn and interact with students (Wolf, 2009). Based on the hypothesis of zone of proximal development—a distance between what a student has achieved and what the student can achieve when offered by appropriate social interactions with adults or more capable peers (Vygotsky, 1978), learning companions can offer appropriate scaffoldings to interact with students, and facilitate the zone of proximal development.

Finally, interface is the channel that determines how many power or benefits students can gain from computer systems, including educational systems. Different from virtual user interface, tangible user interface can empower the potential advantages of the former two considerations (i.e., emotional attachment and learning companions). More specifically, tangible user interface is helpful to the establishment of the emotional attachment to animal companions. When students can use their hands to touch their animal companions or take a physical ball to play with them, the students' perception on the pet ownership and psychological supporting could be enhanced. This will help students develop close relationship with their animal companions. Therefore, the tangible technology (e.g., touch-based petting or combing for their pets) can foster the establishment of the emotional attachment. In addition, tangible user interface can integrate many interaction technologies (e.g., virtual reality, augmented reality, or mixed reality) as multisensory interaction, which could enhance students' motivation and learning performance.

2.2 Implementation

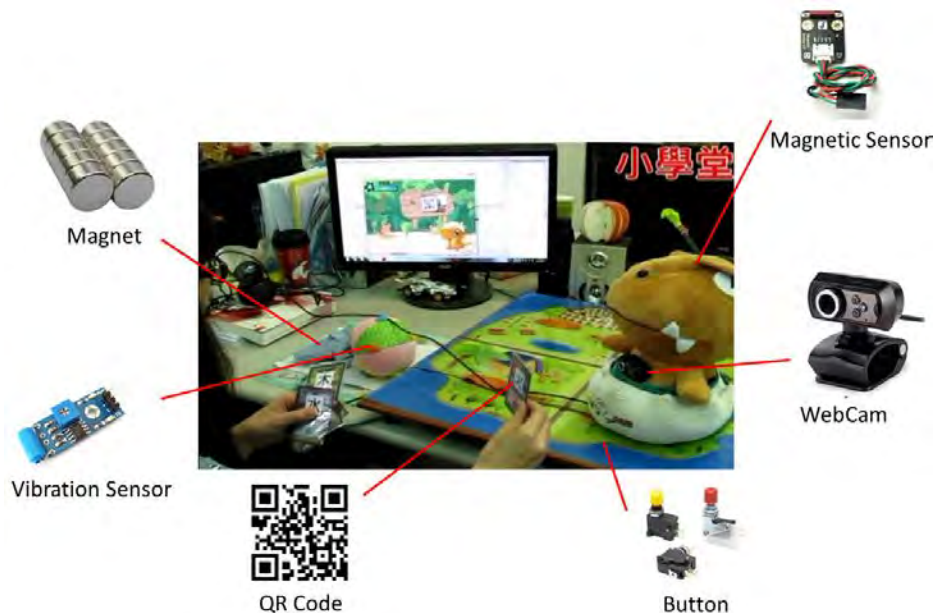

Figure 1. Different sensors and devices embedded in the pet dragon

The implementation of the pet dragon system involves different sensors and devices, including magnet/magnetic sensor, vibration sensor, QR code/WebCam, and buttons (see Figure 1). These sensor and devices are embedded in the pet dragon, a stuffed toy in the shape of dragon. In addition, the pet dragon is also connected to the computer so that some complex or detailed information (e.g., learning materials and feedbacks) can be illustrated on the computer screen.

The learning activity can be divided into three phases: nurturing, learning, and challenging (see Figure 2). In the nurturing phase, a student can see his/her pet dragon in the My Home. The goal of the

student is to establish emotional attachment by taking good care of his/her pet dragon, which is a stuffed toy and the student can touch its head or play a ball with the pet dragon. This function is realized by different sensors and Arduino. These interactive behaviors will influence the dragon whose status is illustrated on the computer screen. In other words, the student can observe the status of the dragon and interact with it.

In the learning phase, the student can strengthen the pet dragon's power by feeding traditional Chinese characters. The goal of the student is to learn more traditional Chinese characters, and then have more opportunities to review what he/she has learned by feeding the dragon correct Chinese characters in the My School. This intention is realized by the character cards with QR codes and WebCam in the pet dragon. When the student takes the correct character card matching the given question on the computer screen, the computer will show the feedback.

In the challenging phase, the student can challenge a series of levels with the pet dragon in the My Arena. The goal of the student is to compete against different opponents in the levels. The activity model in this phase is similar with that in the learning phase. However, different from the learning phase, the challenging phase fosters students' master level of Chinese character learning. This intention is realized by a set of game levels, in which the student needs to take correct character cards in the limited time in these game levels. By doing so, students have more chances to practice what they have learned in the previous phase.



Figure 2. Three phases of the activity for the pet dragon system

References

- Chen, Z. H. (2012). We care about you: Incorporating pet characteristics with educational agents through reciprocal caring approach. *Computers and Education*, 59(4), 1081-1088.
- Fishkin, K. A. (2004). Taxonomy for and Analysis of Tangible Interfaces. *Personal and Ubiquitous Computing* 8(5), 347-358.
- Ishii, H., & Ullmer, B. (1997). Tangible bits: towards seamless interfaces between people, bits, and atoms. In: *Proceedings of the CHI '97 conference on human factors in computing systems*, Atlanta, Georgia, 234-241.
- Ullmer, B., & Ishii, H. (2001). Emerging frameworks for tangible user interfaces. In: Carroll JM (ed) *Human - computer interaction in the new millennium*. Addison-Wesley, New York, 579-601.
- Vygotsky, L. S. (1978). *Mind in society: The development of higher psychological processes*. Cambridge, MA: Harvard University Press.
- Wolf, B. P. (2009). *Building intelligent interactive tutors: Student-centered strategies for revolutionizing e-learning*. Burlington, MA: Morgan Kaufman.

An Investigation of Personality Trait on Asynchronous Computer-Mediated Communication Supporting Speaking Performance

Mei-Jen Audrey SHIH* & Jie Chi YANG

Graduate Institute of Network Learning Technology, National Central University, Taiwan

*audreyshih32@gmail.com

Abstract: The study was designed to offer an extended thread of speaking practice and performance with regard to in-class instruction and after-class exercise in EFL learning environment. To allow students to outspread speaking practice in class, an implementation of asynchronous computer-mediated communication in terms of audioblog was utilized to manage the after-class speaking practice and performance. In the meanwhile, individual difference has been seen as one of the most affected factors to shape learning, such as feature of personality. Thus, the study intended to understand the impact of personality trait would react on audioblog use for speaking performance in English, and the product of the presentation of speaking performance on audioblog. Two research questions were managed as R1: how does personality trait influence students' speaking performance on audioblogs? R2: how do students with different personality trait manage the speaking performance on audioblogs? The participants were three hundred and twenty one male high school students. They were taking an English speaking class for a semester and recruited in the study. After each thematic speaking class, they were instructed to accomplish one thematic speaking performance and post it on their audioblogs accordingly. A mixed method of quantitative and qualitative was analyzed to collect the responses from the students with different personality trait. A few of affected matters from students, as well as the overall presentation of speaking performance on audioblog were gathered for data analysis. The findings of the study showed students with different personality trait affected distinctly on confidence and willingness in English after engaging with audioblog for speaking performance. Those who were inclined to be introverted showed the potential to accomplish more speaking performance than those who were more extroverted. In addition, the implementation of speaking performance on audioblog seemed to significantly influence students' willingness in English after a long-period engagement, particularly to the introverted ones. On the other hand, the overall presentation of students' performances on audioblogs revealed an astounding achievement that not only for the recording style but also the presentation format, and either extroverted or introverted students were apt to favor some presentation formats by the trait of personality.

Keywords: English as a foreign Language (EFL), personality trait, audioblog, speaking performance

1. Introduction

Language skills in term of listening, speaking, reading, and writing were distinguished from general language learning, which to provide an emphasis on specific language skill improvement. However, Sun and Yang (2013) indicated that speaking skill has been seen to have a desperate need of practice in the second language learning. Especially for English as foreign language (EFL) students who lacked of an authentic environment speak in English in daily life (Chiu, Liou, & Chen, 2007; Pong, 2010). As a result, a number of emotional and affected reactions might occur from students' behaviors. For instance, students were deficient in confidence to speak and an influence on their willingness in English. Besides, the individual difference played as an important factor to power English language learning differently. For example, the personality trait was one of the individual differences, but scant of studies have been viewed to apply this feature in language learning context. To this end, a consideration

of not only how to inspire student to be positively affected and be willing to speak more English also how individual difference would impact the language learning with regard to English speaking performance need a well investigation. The study attempted to demonstrate an alternative English speaking instruction design with content and context to fulfill the above-mentioned consideration. In the meanwhile, a facilitation of computer-mediate communication (CMC) was implemented within the study for efficient teaching and learning. Hegelheimer and Tower (2004) revealed the CMC tool has been widely accompanying with its benefits on assisting language learning, and can assist particularly on speaking performance (Alastuey, 2011; Sun, 2012; Yanguas, 2012). There were two modes of CMC tool, which were synchronous and asynchronous approaches, such as chat room or blog, referred to different functions to support various language learning needs. Thus, the study aimed to provide more opportunities for speaking practice in English for students regarding the proposed instructional design, and a highlight on the asynchronous CMC mode was utilized as a tool in the study for after-class English speaking performance. The research questions were addressed as shown. R1: How does personality trait influence students' speaking performance on audioblogs? R2: How do students with different personality trait manage the speaking performance on audioblogs?

2. Literature review

2.1 *Speaking practice in EFL environment*

Alastuey (2011) showed that a lack of practice resulted in inefficient English language development. Regarding the EFL environment, speaking skill was seen to be the most challenged language ability for students due to the insufficient practice. So, several affected matters such as being anxious and being worried about not having confidence would easily block students' speaking development in English. These emotional states often further directly and indirectly influence their willingness in English. Consequently, even if how well-designed speaking activities and exercises were delivered to the students, the instructor did not notice those affected aspects from students on English speaking; the speaking practice from the designed activities would not be affected at all.

2.2 *Asynchronous CMC- audioblog*

One of the effective CMC tools in terms of audioblog was confirmed to provide an asynchronous (delayed time) way to offer learners flexible time to manage communication. Huann and Thong (2006) showed the elements of an audioblog not only consisting of audio condition but also supplementary features, as like visual supports in terms of texts, illustrations, and animations. In addition, Hsu, Wang and Comac (2008) and Sun (2009) have disclosed an implementation of audioblog into an English language class to support speaking development. The results showed positive effects on students' speaking improvement with regard to the engagement of the use of audioblog, and further influenced their motivation and strategy use.

Furthermore, the study attempted to apply the use of audioblog into an English speaking instruction to offer an alternative channel to students for speaking practice in English. In the meanwhile, Fareed (2010) indicated that an aspect on pedagogical setting was important while building an instructional design, which would affect its effectiveness regarding what engagement would be considered into the instruction. Therefore, the study aimed to utilize the audioblog as facilitation to support students' speaking practice in English after class. The reason that not using the audioblog into the classroom instruction was because several concerns which went against the feature of audioblog and might further interrupt the nature of speaking practice in a classroom-based setting. Those concerns were an influence of class size while engaging audioblog-based activity in the classroom; a nonappearance of face-to-face interaction, which lacked of authentic communication; and a limited class time might not afford students to complete tasks on audioblogs. As a result, the use of audioblog in the study was considered as facilitation for the after-class activity, which provided a space to students to develop individual speaking performance concerning the extension of the classroom lesson. Moreover, the study was designed within one phase of a cycle of English speaking instruction, which the audioblog was taken as facilitation to assist after-class speaking practice in English for students. More precisely,

the use of audioblog served the students for speaking practice after school rather than a supplementary in the classroom.

2.3 Personality trait

Personality trait was one of the featured individual differences has been discussed in the language learning. Eysenck and Eysenck (1975) firstly exposed the dimension of personality trait in terms of extroversion and introversion. With the definition, an extroverted learner tended to be fond of engaging with outer world and depended on external information for learning. On the other hand, an introverted learner tended to be fond of the inner space, which would like to think before acting, and was more independent on learning. In other words, the former ones were likely to show their ideas without restrictions while the latter ones were likely to express themselves in a more conservative way. Several previous studies indicated the students with different personality trait showed distinct preferences and language learning performances correspondingly. MacIntyre and Charos (1996) pointed out the introverted learners might be deficiency of willingness in the target language while comparing to the extroverted ones. The result echoed the study of Ehrman (2008) to understand the extroverted learners might be more effective in the target language learning due to the fact that they were more energetic in language learning activities. However, a study from Ehrman and Shekhtman (2005) argued that regarding the characteristics of introversion, the introverted learners have had the latent ability to learn language successfully. Therefore, the consequence of how the personality trait would impact the target language learning was yet answered; especially to the influence of speaking practice and performance in the target language.

3. Methods

3.1 Participants

Three hundred and twenty one high school students in Taiwan were recruited in the study. They attended an English speaking class in order to obtain more speaking opportunities and confidence in English for a semester instruction. Apart from the required English subject class, they did not have other practices and class relevant to English subject at school. Furthermore, all of the students had elementary computer ability, and were familiar with accessing web pages, surf the Internet, and other web 2.0 facilitations, such as email and blog.

3.2 Instruments

Both quantitative and qualitative analyses were employed in the study. Concerning the quantitative analysis, Eysenck Personality Inventory (Eysenck & Eysenck, 1975) enclosed with fifty seven yes and no questions and answers. In order to distinguish students' personality trait on introversion and extroversion, the study focused on examining the measurement of extroversion. By the examining outcomes, it classified students with extroverted leaning (n=164) and with introverted leaning (n=157). Moreover, a self-report survey ($\alpha=.92$) was used to see how students' English speaking performance would be affected by engaging with the audioblog facilitation. The survey was a five-point Likert scale (1= strongly disagree, 2= disagree, 3= neutrally, 4 = agree, 5 = strongly agree). On the other hand, the qualitative analysis was examined by the content and context from the students' audioblogs, and *Google Blogger* was chose for students' audioblog use. It aimed to provide alternative information to apprehend how was the relationship of the performance on their audioblogs and their personality trait.

3.3 Procedure

The English speaking class was keen to offer more various speaking opportunities in English and affected students' speaking performance. Therefore, the study took place in the speaking class every other week at school. There were six thematic English speaking lessons were applied with in-class instruction and practice, and after-class speaking performance. Figure 1 demonstrates a four-phase

cycle of the lesson charted by *thematic oral practice*, *thematic oral composition*, *interpersonal appreciation*, and *sharing and reflection*. More specifically, the first and the last phases of thematic oral practice and sharing and reflection were taken in a classroom-based environment while the second and the third phases of thematic oral composition and interpersonal appreciation were for after-class performance. In the study, the audioblog was applied in the second phase for the after-class thematic oral composition, and allow students to have time to create and complete their individual speaking performance which was relevant to the in-class theme. After each thematic lesson in the classroom, some prompts were given to the students. Such as, a theme “A Dream Trip”, and the following prompts would guide as “what kind of trip would you like to take? When/ where would you like to go? What would you like to do on the trip? Would you like to buy any souvenirs?” The purpose of the prompt was to give students some directions and to build the theme relevant ideas before having an individual speaking performance on their audioblogs, especially to those who have not had initial thoughts to construct their own speaking performance. Later, they had to upload their recordings on their audioblogs as an after-class speaking performance. In order to make sure all the students could accomplish a recording successfully on their audioblogs, the instructor gave a demonstration and showed a complete process of using online recording and embedding on the audioblog. Furthermore, there was no restriction of the length of a recording, and the format of recording is flexible, too. Similarly, the recording was highlighted its clearness and comprehension, which the grammatical error was not the focus in the study.

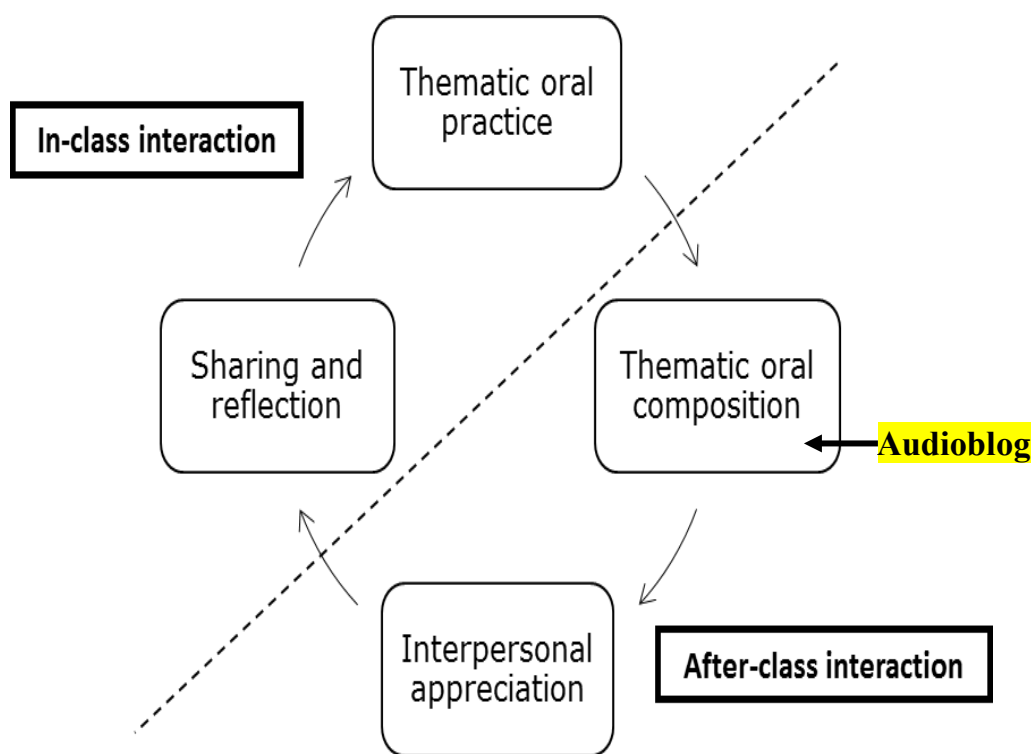

Figure 1. The four-phase cycle of English speaking lesson.

4. Results and discussions

Two research questions were answered regarding the study results. R1 referred to the influence of personality trait on students’ speaking performance on audioblogs, and R2 discussed the diverse speaking performances of students with different personality trait accordingly. First of all, the descriptive analysis showed that the average speaking performance uploaded on students’ audioblogs, which the introverts (mean= 4.14, S. D.= 1.94) and the extroverts (mean= 3.37, S. D.= 1.93). The result indicated that the introverted students have accomplished more speaking performances on their audioblogs than the extroverted ones, and might further lead to a potential outcome that the introverted

students could gain more advantages towards the use of audioblog for the after-class activity on speaking practice and performance. Besides, an examination of *t*-test was to show an impact of the personality trait to students' speaking performance on audioblogs.

Table 1 displays the students with extroverted and introverted tendency would affect separately after engaging with speaking task on audioblog for a semester. The results presented a significant difference on willingness in English ($t= 2.60, p<.01$) between the extroverted and introverted students. However, there was no significant difference on the impact of confidence in English ($t= 1.73, p>.05$) between the extroverted and introverted students. In other words, the implementation of recording exercise on audioblog seemed to make an influence to capably encourage students' willingness in English after a long-period engagement although it was a pity to see there was no statistical effect on students' confidence in English.

More specifically, Table 2 illustrates the mean score of confidence and willingness in English to identify whether the significant difference appeared between the extroverted and introverted students. Thus, with regard to the effect significantly acted on willingness in English between students with extroverted and introverted inclination, the result further uncovered that the introverted students (mean= 3.74, S. D.= .79) outperformed the extroverted ones (mean= 3.48, S. D.= 1.02). In sum, the introverted students were more likely to obtain profits from the exercise of English speaking practice and performance on their audioblogs for after-class exercise than the extroverted students. The benefits in terms of reinforcement on willingness in English greatly exhibited to the introverts. The finding was remarkably to previous studies that mentioned the introverts were more reticent than the extroverts, which exhibited a less willingness in the target language. However, with alternative channel facilitation, as the study engaged with audioblog for after-class speaking practice and performance, it offered the introverted students to have the target language speaking practice in a more comfortable zone. Ultimately, the audioblog facilitation for the after-class speaking exercise created a means to benefit more the introverted students on target language speaking development than the extroverted ones.

Table 1: Impact of personality trait on confidence and willingness in English.

		t-test for Equality of Means			
		t	df	Sig. (2-tailed)	Mean Difference
Confidence	Introvert	1.73	315	.09	.17
	Extrovert				
Willingness	Introvert	2.60	305	.01	.26
	Extrovert				

Table 2: The mean of confidence and willingness in English for introverts and extroverts.

		N	Mean	Std. Deviation
Confidence	Introvert	157	3.77	.83
	Extrovert	164	3.60	.96
Willingness	Introvert	157	3.74	.79
	Extrovert	164	3.48	1.02

In addition, R2 was to see the overall presentation of speaking performance in English on audioblogs from both extroverted and introverted students. The speaking practice and performance on audioblog in terms of speaking recording exercise was founded with a theme which was a following-up of the in-class English speaking practice. Furthermore, a few theme-relevant prompts would list to allow students to extend, brainstorm, and construct ideas for speaking exercise on their audioblogs individually. As a result, students could feel free to manage the time to upload their speaking recording

exercise on audioblog before next class. The average duration of each recording was approximately between half a minute to two minutes. Due to the fact that there was no limitation of recording style, the role of students was various while producing the recordings. Regarding students' recording performances, it was fascinating to discover some of the students not only simply played as a narrator but also acted as a double role for Q and A, a radio host, and even a video channel host. The creativity of recording style shaped how the students constructed the recording content and context. Likewise, with regard to the presentation format of the recording on audioblog, several examples of the recording on audioblog presented diverse appearances.

Figure 2 illustrates vivid examples of a few recording performances on students' audioblogs. Not only to upload the audio recording, but also to supplement the oral recording content with (A) text note/ script, (B) drawing/ picture, and (C) text with picture. Additionally, a presentation of reflection as a journal (D) was captured. The use of audioblog offered individual student a space to maintain his speaking performance every other week. Initially, the purpose of the audioblog use was to give students an alternative opportunity for speaking practice after class. Therefore, the expected outcome of students' performance was the audio recording solely. However, concerning the feature of audioblog which allowed diverse types of presentation, it was attention-grabbing to see other varied presentation formats of performance from students' efforts. Not only with a combination or supplementary of text or script messages, images, but also a maintenance of journal reflection was illustrated from students' performances. Moreover, a different inclination of the presentation format of performance was discovered through students with dissimilar personality trait. The extroverted students were found out more attempted to utilize complementary information and figures to enrich their audio performances (see examples A/ B/ C of figure 2) while the introverted students less endeavored to add supplementary within their audio performance. Yet, an introverted student was inclined to demonstrate a reflected performance on his audioblog (see example D of figure 2). By keeping a text memo within each audio recording, he tried different approaches to complete the performance, which in turn to reveal an inner interaction of carrying out the performing progress. In sum, students' performances on audioblogs showed a surprising accomplishment which not only for the recording style but also the presentation format. Furthermore, either extroverted or introverted students were apt to favor some presentation format by the trait of personality.



(A) text note/ script



(B) drawing/ picture

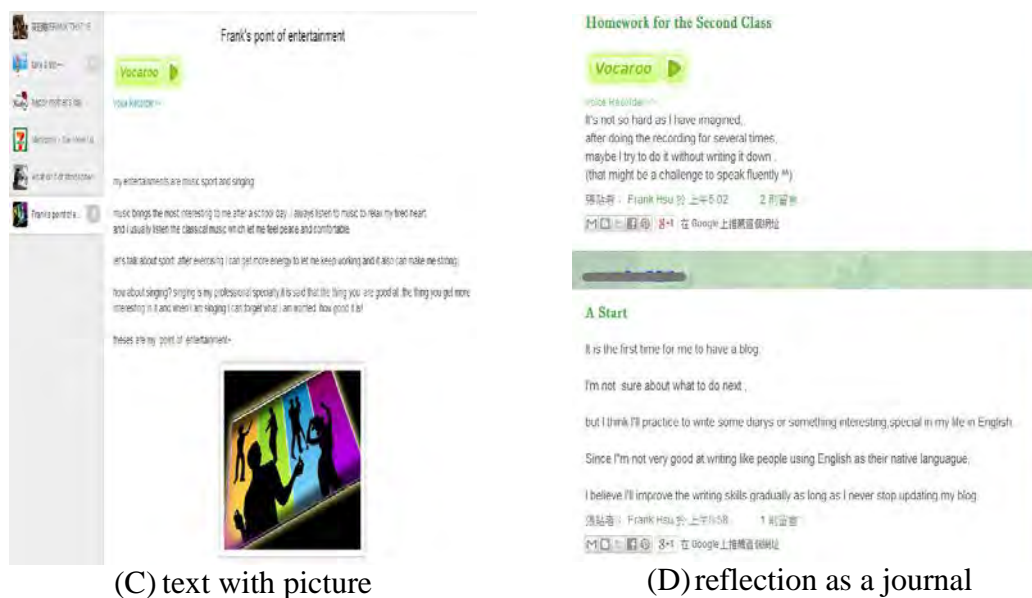

Figure 2. Examples of the presentation format of recording on audioblog.

5. Conclusion

The study conducted an EFL speaking instructional design in order to outspread speaking practice in English from the classroom-based environment to the after-class setting. With the extension of the in-class thematic speaking lesson and practice, students needed to accomplish a thematic relevant speaking performance on their own audioblogs during the after-class time. The form and structure of the speaking performance was yet restricted as long as it was related to the theme. Additionally, students could either refer to similar discussion or other aspects with regard to the theme to complete their own speaking performances on audioblogs afterwards. Therefore, an understanding of how the personality trait would affect students on the speaking practice and performance on audioblog, and a general presentation of speaking performance towards students with different personality trait. As a result, through extending the in-class thematic speaking instruction every other week, students were guided to complete one thematic speaking performance in English on their audioblogs after class. The findings of this study showed that students with different personality trait did influence distinctly on confidence and willingness in English after engaging with audioblog for speaking performance. More precisely, those who were inclined to be more introverted showed the potential to accomplish more recording exercises than those who were more extroverted. In other words, the implementation of speaking performance on audioblog seemed to impact on students' willingness in English after a long-period engagement, particularly to the introverted students. However, the students' confidence in English did not reveal any improvement regarding the study. Additionally, the overall students' performances on audioblogs showed an astounding achievement that not only for the recording style but also the presentation format, and either extroverted or introverted students were apt to favor some presentation formats by the trait of personality. By the understanding can further examined qualitatively how the students with different personality trait would prefer the recording style and presentation format on audioblog for an implication on sharpening EFL speaking instruction.

Acknowledgments

The authors would like to thank all the subjects who participated in the study. This study was partially supported by a grant (NSC 102-2511-S-008-003-MY3) from the National Science Council of Taiwan.

References

- Alastuey, M. C. B. (2011). Perceived benefits and drawbacks of synchronous voice-based computer-mediated communication in the foreign language classroom. *Computer Assisted Language Learning*, 24(5), 419-432.
- Chiu, T., Liou, H., & Yeh, Y. (2007). A study of web-based oral activities enhanced by automatic speech recognition for EFL college learning. *Computer Assisted Language Learning*, 20(3), 209-233.
- Ehrman, M. E. (2008). *Personality and good language learners*. In C. Griffiths (Ed), (pp. 61-72). Cambridge: Cambridge University Press.
- Eysenck, H. J., & Eysenck, S. B. G. (1975). *Manual of the Eysenck personality inventory*. London: Hodder & Stoughton.
- Fareed, W. (2010). Affordance analysis of an audioblog and suggestions for its recruitment and use on oral lessons. *International Journal of Instructional Technology and Distance Learning*, 7(8), 55-65.
- Hsu, H. Y., Wang, S. K., & Comac, L. (2008). Using audioblogs to assist English-language learning: An investigation into student perception. *Computer Assisted Language Learning*, 21(2), 181-198.
- Léger, D. S., & Storch, N. (2009). Learners' perception and attitudes: Implications for willingness to communicate in an L2 classroom. *System*, 37(2), 269-285.
- Leaver, B. L., Ehrman, M. E., Shkhtman, B. (2005). *Achieving success in second language acquisition*. Cambridge: Cambridge University Press.
- Macintyre, P. & Charos, C. (1996). Personality, attitudes, and affect as predictors of second language communication. *Journal of Language and Social Psychology*, 15(1), 3-26.
- Pong, K. H. (2010). Learners' anxieties on posting their own speeches on YouTube.com: Facilitative or debilitating? *College English: Issues and Trends*, 3, 73-100.
- Sun, Y. C. (2009). Voice blog: An exploratory study of language learning. *Language Learning and Technology*, 13(2), 88-103.
- Sun, Y. C. (2012). Examining the effectiveness of extensive speaking practice via voice blogs in a foreign language learning context. *CALICO Journal*, 29(3), 494-506.
- Sun, Y. C., & Yang, F. Y. (2013). I help, therefore, I learn: Service learning to Web 2.0 in an EFL speaking class. *Computer Assisted Language Learning*. 1-18.
- Yanguas, Í. (2012). Task-based oral computer-mediated communication and L2 vocabulary acquisition. *CALICO Journal*, 29(3), 507-531.

Comparison of Kit-Build and Scratch-Build Concept Mapping Methods on EFL Reading Comprehension

Mohammad ALKHATEEB^{a,b,*}, Yusuke HAYASHI^a, Taha RAJAB^c and Tsukasa HIRASHIMA^a

^a Graduate school of engineering, Hiroshima University, JAPAN

^b Faculty of mechanical and electrical engineering, Tishreen University, SYRIA

^c Department of Languages, HLSS, Manchester Metropolitan University, UK

* Mohammad@lel.hiroshima-u.ac.jp

Abstract: In generally the reading comprehension is a very difficult task for students in all the stages of study, especially when they are reading text in a foreign language, the EFL reading” (English as foreign language) is one of the most common research topics in the learning field. This study aimed to investigate the effect of teaching EFL reading comprehension to Japanese students through Kit-Build concept mapping (KB-mapping) method. In doing so, we have conducted an experiment to compare the student comprehension with KB-mapping and Scratch-Build Concept Mapping (SB-mapping) Methods. In doing so, a comprehension test and delayed comprehension test (two weeks after using) were used. By comparing the results of the Comprehension Test (CT) scores and the Delayed Comprehension Test scores (DCT) for the both conditions groups, we found that the using of KB-mapping had the same effects of SB-mapping in the understanding the text just after the using, but KB-mapping had better effects in the recalling and remembering the text after a while.

Keywords: Technology-Enhanced Learning, Kit-Build Concept Map System, Reading Comprehension, EFL.

1. Introduction

Reading comprehension is one of the important learning activities, and needs a special ability from the learners to reap its benefits (Alkhateeb & Hirashima 2013). Reading comprehension poses many challenges such as slow reading, insufficient vocabulary comprehension and bad recalling (Alkhateeb & Hirashima 2014). Researchers have always tried to support this learning activity, by proposing methods or strategies. The main goal is to boost the comprehension skills in the target subject area. When they are deployed in a language course, the main aims are to improve student reading comprehension skills and to contribute to the acquisition of the target language (Rayner & Seidenberg 2001).

In this research, we are trying to support this complex learning task by using our KB-mapping method (Sugihara & Hirashima 2012). We have been developing learning tools to help both students and teachers within the learning process. One of these tools is Kit-Build concept map (KB-map). We found it a very useful tool for learning the sciences for the students in mother languages (Sugihara & Hirashima 2012), and we found that this tool yield good results for teachers and students. It should be noted that KB-map is a special kind of concept map and the using of KB-map needs a lot of concentration to recognize the two concepts that can be connected by a relation.

To investigate the effects of using KB-mapping, we designed an experiment where we compared the Scratch Concept mapping method (SC-mapping) for reading comprehension with our KB-mapping method. As known the SC-mapping is a flexible method that may be tailored to fit various types of information, and different skill-levels. As students read an EFL text, SC-mapping helps them learn to pay attention to the essential information within the text.

1.1 EFL Reading Comprehension

'Comprehension' as a concept is defined as "the ability to understand something" in the Oxford Dictionary, the definition of Cambridge Dictionary is "the ability to understand completely and be familiar with a situation, facts, etc."; For the purpose of this research, 'reading comprehension' will be defined as "a learner's ability to understand completely and memorize the important information that is included in the text that he/she is reading". The definition necessarily includes the level of understanding of a text/message. Such an understanding comes from the interaction between the written words and how they trigger knowledge outside the text/message (Sugihara & Hirashima 2012).

The reading comprehension in an EFL context is a special case of reading comprehension; it is highly complex, dynamic, multi-componential and multi-dimensional task in the learning process. We can explain it as multiple interactions between the reader background and knowledge in his Mother Language (ML) and in the Target Language (English). Broadly speaking, the reading comprehension of EFL is the same as the ML reading comprehension but it is slower and less successful than ML reading (Neil Anderson 1999). This can be explained in that the reading process is depending on many factors such as the level of reader's language proficiency, type of text, text difficulty and task demands.

It is a difficult task for students at all stages of study, especially when they are reading texts in a foreign language. Therefore, EFL reading has attracted attention in the teaching and learning field. Many researches came up and proposed methods, techniques and strategies to help students reading abilities. These attempts yielded significant improvements in students' comprehension just after using the proposed methods or the strategies. To mention a few of these methods, there are the Selective Underlining Strategy, Note-Taking Skills Reading (Piola & T.keelllogg 2005), SQ3R (Survey, Question, Read, Recite, Review) (Huber & Jennifer A. 2004). The most new strategies that proposed to support the reading comprehension task are the Graphic Organizers (GOs) as a reading strategy used both in the teaching and learning of languages. As examples of GOs are Story Maps, matrix, Semantics Maps, Knowledge Maps and scratch concept map (Manoli & Papadopoulou 2012).

Several investigations of reading comprehension strategies have specifically addressed challenges related to reading expository text. Positive outcomes have been found for students who were taught strategies to help students identify main ideas.

1.2 Scratch concept mapping method

SC-mapping is one of the most newly strategies that used to support the reading comprehension learning task and it gives good effects on EFL student's reading comprehension.

SC-map is visual representations of knowledge which can be employed as a learning strategy by the learners to find the relationship between current knowledge and new information (Salehi & Khodabandehlou 2013). The researches confirmed that the EFL students whom had treatment concept mapping gained high scores in reading comprehension (Salehi & Khodabandehlou 2013). Also there are many studies of students learning English reading through the use of concept maps showed that the concept mapping training or the semantic mapping technique could improve the students' reading comprehension because they could understand the text more easily through the concept map (Phantharakphong & Pothith 2014) (Chularut & DeBacker 2004).

Scratch concept mapping provides students with opportunities to become actively involved in their learning while linking knowledge to long term memory. Through the use of concept maps, students have opportunities to organize their thoughts in a concrete and/or graphic/visual format, while connecting concepts and linking prior knowledge to new knowledge. Related concepts become connected rather than fragmented. Concept maps also provide them with opportunities to think about their own thinking as they reflect on their conceptual understandings. The process of map drawing has a positive impact on student's awareness of the reading process and they can manage to have more control over reading comprehension in English by visually representing what is conveyed in the texts they read (Salehi & Khodabandehlou 2013).

1.3 Purpose of this experiment:

We have been developing learning tools to help both students and teachers in the learning process. One of these tools is KB-map. This tool was used in many fields of learning and we found that this tool has good effects in the reading comprehension of EFL students (Alkhateeb & Hirashima 2013). And it has effects in the remembering and recalling of the comprehended text after a while (Alkhateeb & Hirashima 2013). Also we found it very useful for learning sciences to the students in their mother languages (Sugihara & Hirashima 2012) and some studies suggest that KB-mapping is promising tool to estimate learners' understanding in class-room by using the diagnosis and feedback with the KB-map (Yoshida & Hirashima 2013), (-Funaoi& Hirashima 2012)).It also has good effects for the teachers and students.

Recently there are many researches proposed the scratch concept mapping method as a very effective method to support the EFL student's reading comprehension task, and they found that SC-mapping method is good for comprehend the text and for recalling.

In this research, we are trying to use KB-mapping method to support the reading comprehension of EFL students again by comparing it with the SC-mapping method to confirm the effects of KB-mapping and SC-mapping in the comprehension and recalling of the English text.

2. Kit-Build concept mapping Method

2.1 Overview of Kit-Build Concept Map

KB-map is “a framework to realize automatic diagnosis of concept maps built by learners and to give feedback to their errors in the maps” (Sugihara & Hirashima 2012). KB-map is a special kind of concept map. The creation of concept map consists of two steps: the extraction of the concepts and the relations from the text and the selection of the responsible relation that connects two concepts together. In KB-mapping, the supervisor makes the first step by creating the goal map from text and after that he can generate the kit from the goal map by dividing the goal map to concepts and relations, providing learners with this kit. After that, learners are tasked to build the concept map (called learner's map) by using the concepts and the relations that provided in the kit.

2.2 KB-map System

We have already developed a system based on the KB-map, explained in the previous section. This system is called as “KBmap System”. It is a web application with two client systems: “Cmap Editor” and “KBmap Analyzer”, and a server system: “KBmap DB”. Cmap Editor provides an environment for the teacher, or the supervisor, to make a goal map kit, and for learners to make a learner's map. This system has been implemented by Java (version 1.6). KBmap Analyzer has functions to gather learner maps online, generate a group map and diagnose the maps. This system has been implemented by Flash and it supports Flash Player version 10. KBmap DB has a function to store and share maps. This system was developed by Ruby (version 1.8.7) on Rails (version 1.2.3) and MySQL (version 5.1.30) (Sugihara & Hirashima 2012).

The new version of Cmap editor has the functions to add concepts and relations to the learner's map so we can use it as computerized SC-map editor in addition to the original use to create KB-map from the provided kit, and this version use the Point & Click functionality so the students can use it very simply to create the student's SC-map. Figure 1 shows a part of the Cmap editor with the functional options.

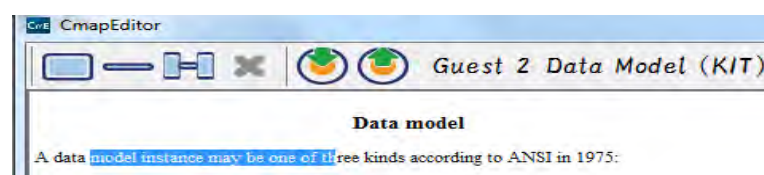

Figure 1. Part of the Cmap editor.

3. Experiment Methodology

Our research investigates the effects of using KB mapping method as a supportive tool for the reading comprehension tasks by comparing them with the effects of using SC-mapping method from two points of view:

1. In the short-term view: we are measuring the understanding of the participants just after using our method, and comparing it with the understanding of other participants who use SC-mapping method with the same conditions.
2. In the long-term view: we are measuring the recalled information of the participants two weeks after using our method, and comparing it with another participants' information who use SC-mapping method with the same conditions.

In this chapter we introduce three points of our experiment: the participants, the outline procedure of whole experiment and the detailed procedure of one session.

3.1 The Participants

The participants of our experiment are 11 Japanese students. They are in 3rd year and studying in the information engineering faculty. Their scores in TOEIC exam ranged from 390 to 730, so they had different reading abilities of English texts. We prepared an aptitude test to check their abilities in the reading comprehension. By using the information of their TOEIC records, the TOEIC reading scores and the aptitude test scores, we grouped them into two groups A (***) is the average TOEIC score) and B (***), which are almost commensurate with the reading ability.

We have done our experiment in 6 sessions and the two groups changed the conditions alternately. Every participant underwent three times the experimental conditions and three times with control conditions.

3.2 Procedure of the whole experiment

We planned to complete this experiment in six sessions of reading comprehension tasks for six different English texts. Firstly we introduced to the participants the strategy of this experiment, the procedure of every session and KB-map system. For the others session we started with the delayed comprehension test of the previous session. After that they did the current session, finally we did questionnaire at the end of the last session of the experiment. During this experiment every group did it with the experimental conditions for three times and with control conditions three times too. We tried to keep the balance between the different texts of this experiment.

3.3 Procedure of the first session:

In the experimental use, we are comparing the effects of using KB-mapping method and the effects of SC-mapping strategy in the reading comprehension process. We are measuring these effects over two stages: just after the using and after a while. We have designed the learning activity in this experiment in a limited period of time to avoid the effects of other supporting strategies. The process of one session, as shown in Figure 1, consisted of four steps:

In the first 10 minutes, both conditions groups were requested to comprehend the whole text by skimming it translating the difficult words in the text using a dictionary. Then, in the next 10 minutes the experimental conditions group was required to build the learner's KB-map of the text by using KB-editor and in the same time the control conditions group was required to build the learner's SC-map of the text by using KB-editor. After that both groups answered the comprehension test within five minutes. Finally, after two weeks both groups answered the delayed comprehension test.

time	Experimental conditions	Control conditions
10 min	Reading the materials (using dictionary is allowed)	
20 min	Making the KB-map by using KB-editor	Making the SC-map by using KB-editor
5 min	Comprehension test (CT)	
5 min	Delayed Comprehension test (DCT) (2 weeks after)	

Figure 2. The procedure of one session.

4. Experimental use

This experiment was done in 6 sessions with two groups of participants (A, B). Both of them had almost the same reading ability. For each group they use the KB-mapping method for 3 sessions and the SC-mapping method for 3 sessions too. In this chapter we introduced three points: the preparation of the used materials, examples of the real materials used in one session of this experiment.

4.1 Materials Preparation

Participants in this experiment were students in 3rd year at the faculty of information engineering, so they were interested in the topics of information engineering. Firstly we selected a text from Wikipedia in the information engineering field and checked it for the grammatical and semantically error. After that we created the corresponding KB-map (Goal map) that covered the main concepts and relations of the text. We prepared the comprehension test. And we checked all of the material again to be sure that materials did not contain any error. Finally we checked if the answers of questions of comprehension test were covered by the KB-map to marking the questions that were not covered.

4.2 Example of experimental material

In this section, we introduce one example of the materials that was used in the third session of our experiment. Figure 3 shows a part of the text that was used as the original text which learners tried to comprehend it. The participants requested to read and comprehend this text within 10 minutes and they had the ability to use online dictionary to translate the complex and unknown words to help them in understanding the whole text.

A language is typed if the specification of every operation defines types of data to which the operation is applicable, with the implication that it is not applicable to other types. In most programming languages, dividing a number by a string has no meaning. Most modern programming languages will therefore reject any program attempting to perform such an operation. In some languages, the meaningless operation will be detected when the program is compiled ("static" type checking), and rejected by the compiler, while in others, it will be detected when the program is run ("dynamic" type checking), resulting in a runtime exception."

Figure 3. Sample of the used text in the third session.

After that, the experimental conditions group tried to build learner's KB-map, within 20 minutes, by using the kit that was provided by the system which generated it from the corresponding goal map. Figure 4 shows the goal map of the text that was prepared by the supervisor. It contains most of the information of the original text; this goal map is divided by the system to generate the kit that is shown in Figure 5. Figure 6 shows one example of the learner's KB-map.

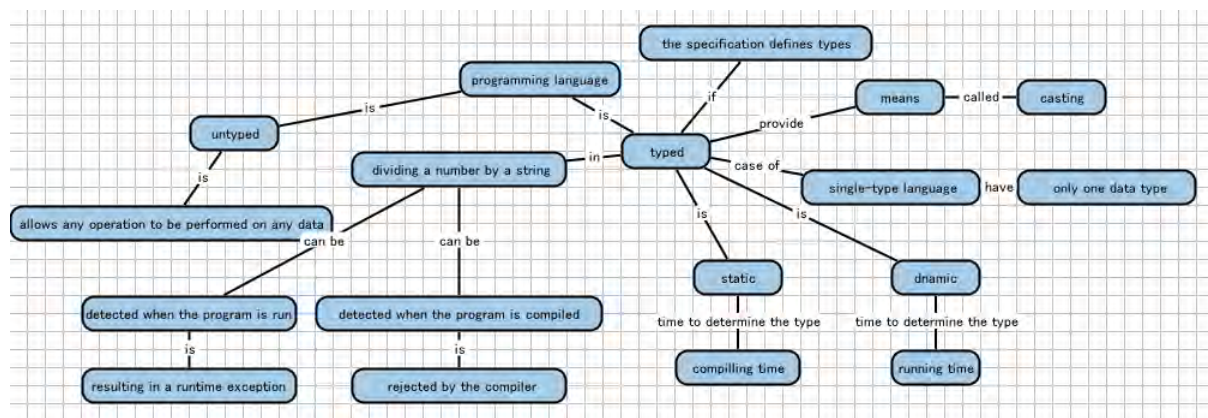

Figure 4. The Goal map of third session.

At the same time, the control conditions group tried to build learner's SC-map within 10 minutes too. The SC-map contains the important information of the text. Figure 7 shows one example of the learner's SC-map of the same text.

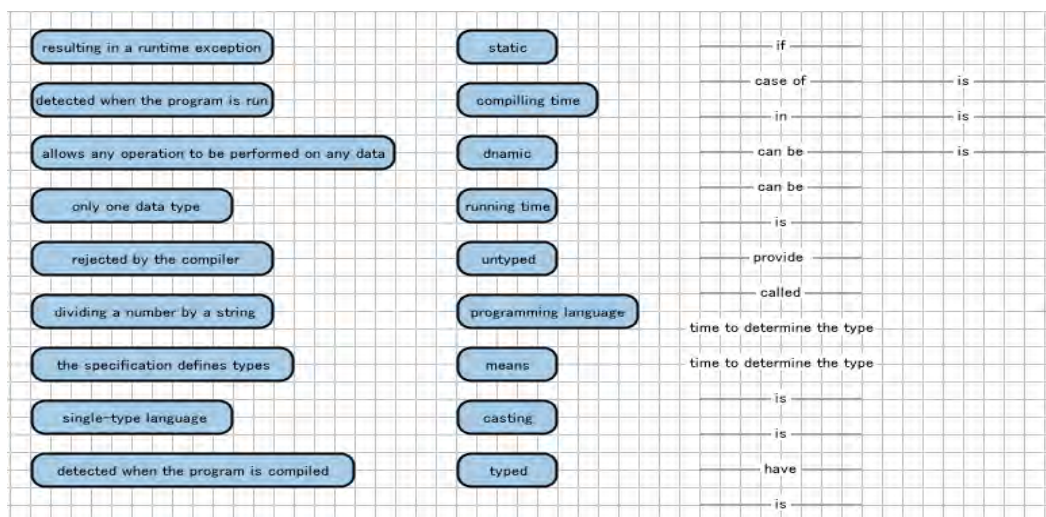

Figure 5. The kit of third session.

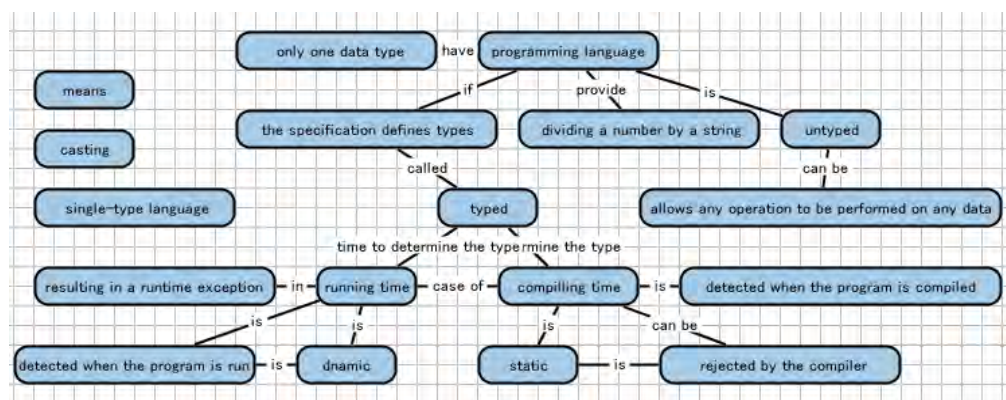

Figure 6. Example of the learner's KB-map.

After that all the participants did the same comprehension test within 5 minutes which is a set of multi-choices questions. All of these questions are asking about information included in the original text, some of them are included in the goal map and some are not, and for the SC-mapping it is the same. Figure 8 shows a part of the comprehension test of this session.

By the end of this test they finished the experimental use of that day and 2 weeks after they did the comprehension test again as a delayed comprehension test.

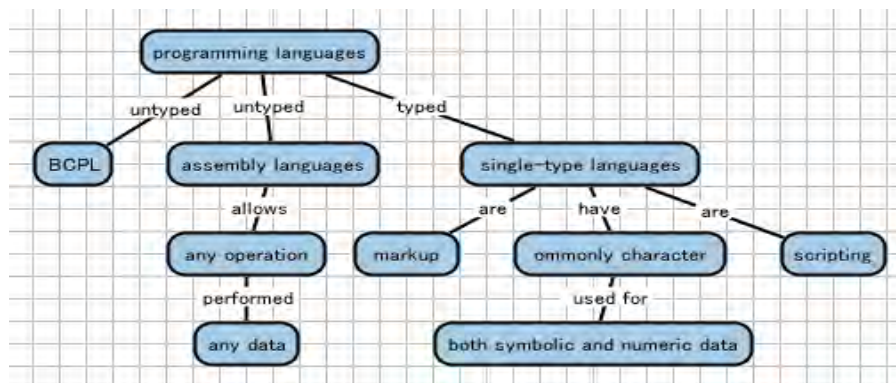

Figure 7. Example of the learner's SC-map.

Q2: with typed languages, if the error of types of data did not discovered in compiling can we discover it?			
a. can	b. cannot.	c. can with conditions	d. I don't know.
Q3: In the untyped languages can we do operation with two types of data?			
a. can	b. cannot.	c. can with conditions	d. I don't know.
Q4: with untyped languages, if the error of types of data did not discovered in compiling can we discover it?			
a. can	b. cannot.	c. can with conditions	d. I don't know.

Figure 8. Samples of the comprehension test.

5. Results:

We performed our experiment with 11 students in 6 sessions. In three sessions we had 5 participants as experimental conditions group and 6 as control conditions group and in the others we had 6 participants as experimental conditions group and 5 as control conditions group. The participants were exchanging the conditions every session.

So we had 33 scores as experimental conditions and 33 scores as control conditions, by analyzing these results we found that the using of KB-mapping method has the same effectiveness of the SC-mapping method for the comprehending of the text just after using the methods (comprehension test), but the KB-mapping method is more effective for recalling the comprehended information from the text after a while (Delayed comprehension test). The detailed results are presented in this section and we are presenting the results of the questionnaire that we did it in the last session.

5.1 Comparing KB-map Conditions group Scores and SC-map Conditions group Scores

By comparing the results of the Comprehension Test (CT) scores and the Delayed Comprehension Test (DCT) for the both conditions groups, we found that, for the Experimental Conditions Group (EC), the average difference between the DCT and the CT is -7.76 and for the Control Conditions group (CC), the average difference between the DCT and the CT is -17.23. We can notice that the differences of the EC group are better than the differences of the CC group for all the sessions of the experiment. And for more confirmation of these results we did more detailed analysis of the delayed CT and the CT scores of the two conditions group. Tables 1,2 shows the results of the T-Test for our results.

➤ For the comprehension test:

By comparing the comprehension test scores of the both conditions groups we found that the total average score of the experimental conditions group is slightly better than the control conditions group average score. For every session we found the same results. Figure 9 shows the average score for every session. For more confirmation of this result we used the statistical test student's TTest. By using the this test we found that there is not a real difference between the CT scores of the two conditions groups but as we see in table 1 ($P(TTest)=0.191 > 0.05$) that the average score of the EC group is slightly better than the average score of the CC group.

Table 1: the comprehension Test average score.

CT. Scores	Experimental conditions group	Control Conditions group
Mean	85.313	80.323
SD	11.986	16.941
P(TTest)	0.1910	

Table 2: the delayed comprehension Test average score.

DCT. Scores	Experimental conditions group	Control Conditions group
Mean	79.063	66.1293
SD	12.083	20.269
P(TTest)	0.004	

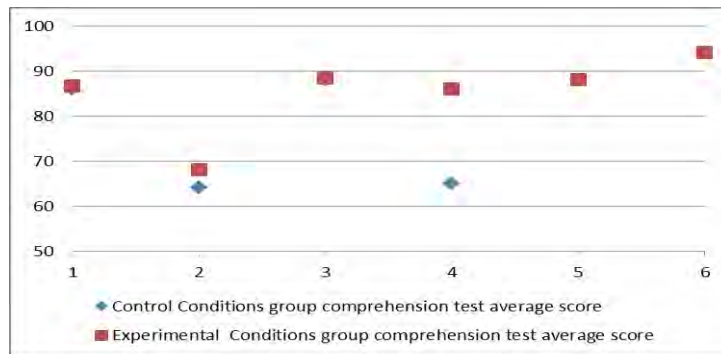

Figure 9. CT Average Scores for Experimental Conditions group and Control Conditions group for each session.

- For the Delayed Comprehension test:
By comparing the Delayed comprehension test scores of the both conditions groups we found that the total average score of the experimental conditions group is better than the control conditions group average score. For every session we found the same results. Figure 10 shows the average score for every session. For more confirmation of this result we used the statistical test student's TTest. By using the this test we found that there is a significant difference between the DCT scores of the two conditions groups but as we see in table 2 ($P(TTest)=0.0040 > 0.01$) that the average score of the EC group is better than the average score of the CC group.

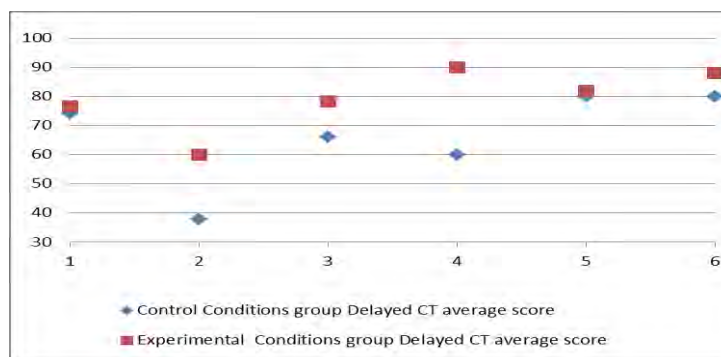

Figure 10. DCT Average Scores for Experimental Conditions group and Control Conditions group for each session.

5.2 The questionnaire results:

After we finished the last session, the participant answered the questionnaire to evaluate the learning method of using KB-mapping and compared it with the SC-mapping method. Table 3 shows the results of this questionnaire.

Questions (1-6, 9&10) are 5 multiple-choices questions that measure the participant's agreement with the mentioned point by the question. The choices used are (A. Strongly agree, B. Agree, C. Natural, D. Disagree and E. Strongly Disagree), and the questions (7&8) are 3 choices questions that compare between the two learning methods. The choices used are (A. KB-mapping, B. Same, C. SC-mapping). To normalize the results of this questionnaire, we tried to summarize all the results of our questionnaire and converted them to arithmetical form that means (1 Strongly Agree, 0.5 Agree, 0 Natural, -0.5 Disagree, and -1 Strongly Disagree). At the same time, it means (1 KB-mapping, 0 same and -1 SC-mapping). As a summarization of the questionnaire evaluation, 0 means the normal, the positive means agreement and the negative means disagree and the value shows the strength of the agreement or the disagreement.

In questions (1&4&7)(2&5)(3&6), participants thought that the KB-mapping method was as useful to understand English text as the SC-mapping. They also said that it was useful to answer the comprehension test just after the learning activity. But they thought that KB-mapping method was more useful to answer the delayed comprehension test two weeks after. Also in questions (8, 9) they thought that the KB-mapping method is easier to carry out, and they like to use KB-mapping method in reading comprehension task but they needed more time to do it.

Table 3: Evaluation of the proposed methods for EFL comprehension.

N	Explanation	Average Agreement
1	Do you think that SB-mapping was useful to understand English text?	0.4
2	Do you think that SB-mapping was useful to answer the test after reading?	0.5
3	Do you think that SB-mapping is useful to answer test two week later?	-0.05
4	Do you think that KB-mapping was useful to understand English text?	0.6
5	Do you think that KB-mapping was useful to answer the test after reading?	0.55
6	Do you think that KB-mapping is useful to answer test two week later?	0.1
7	Which method is more useful to understand English text?	0.6
8	Which method is more difficult to carry out?	-0.6
9	Do you like to use KB-mapping to understand English text?	0.2
10	Do you like to use SB-mapping to understand English text?	0.05

In general, we can say that the participants thought that the using of KB-mapping is similar to the SC-mapping for comprehension test but it was more useful to recalling the information after a while and it was easier to carry out. They liked to use it in reading comprehension task.

5.3 Considerations

The results of this experiment show that the using of KB-mapping method has almost the same efficiency as the using of SC-mapping method for comprehending the English text just after the using (the comprehension test), so we can say that the provided kit by the system has no advantage for the EC group to understanding the text in comparing with the SC-mapping method. But the KB-mapping method has better efficiency for recalling after a while (the delayed comprehension test). We can explain these results as the Using the KB-mapping required concentration in reading the text and the need to read with attention to distinguish the two concepts that could be related and to find the corresponding relation that can connect them together. At the same time, this process required the learner to understand the information in the text deeply and required them to comprehend the text in whole. But for the SC-mapping, the learner can parse the text sentence by sentence to distinguish the important concepts in the sentence and the corresponding relation that connects them in the same time. So we can explain our results by the required high load on the learner memory to comprehend deeply the whole text to complete the student map, this load force the learner’s memory to keep most of the information that he has already comprehend.

6. Conclusion and future work:

In this paper, we describe the effects of using KB-Mapping method as a supportive tool for the reading comprehension of English texts as EFL reading.

Overall, from this experiment we can conclude that the using of KB-map as learning supportive tool for reading comprehension is as good as SC-mapping in the short term, but it so better for the long term.

Our next step goal is to generalize the results for larger groups, the research should be extended its time and the study should have been involved more participants at different levels. We are looking to study the effects of using KB-mapping method in the learner’s reading comprehension skills and developing more attractive environment to support this special kind of learning activity for enhancing text learning. Even given its limitations, this study has provided many ideas for ways to modify teaching practices. It seems that KB-mapping can help to stimulate and challenge students to look deeper into their reading. The scope of this study was only limited to reading comprehension. It is suggested that in future research the scope should be expanded in terms of other three important skills; writing, speaking and listening. By making the scope wider, the researchers can get a clear view of the utilization of KB-mapping in all aspects.

Acknowledgements

We would like to thank all the people who participate and support us in our experiment.

References

- Aek Phakiti(2006): Theoretical and Pedagogical Issues in ESL/EFL Teaching of Strategic Reading, University of Sydney Papers in TESOL, 1, 19-50
- Anahita Deylam Salehi, Shahrokh Jahandar & Morteza Khodabandehlou (2013): the impact of concept mapping on EFL student's reading comprehension. Indian Journal of Fundamental and Applied Life Sciences ISSN: 2231-6345 pp.241-250
- Annie Piolat, Thierry Olive & Ronald T. Keilllogg (2005): Cognitive Effort during Note Taking, Proc. Applied Cognitive Psychology Volume 19, Issue 3, pages 291–312
- Hideo Funaoi, Kouhei Ishida & Tsukasa Hirashima (2012): Comparison of Kit-Build and Scratch-Build Concept Mapping Methods on Memory Retention, Proc. of ICCE2011, pp.539-546.
- Huber & Jennifer A (2004): A Closer Look at SQ3R, Proc. Reading Improvement Vol. 41 Issue 2, pp.108-112. 5
- Kan Yoshida, Kouta Sugihara, Yoshiaki Nino, Masakuni Shida & Tsukasa Hirashima(2013): practical Use of Kit-Build Concept Map System for Formative Assessment of Learners' Comprehension in a Lecture, Proc. of ICCE2013.
- Kazuya Yamasaki, Hiroyuki Fukuda, Tsukasa Hirashima & Hideo Funaoi (2010): Kit-Build Concept Map and Its Preliminary Evaluation, Proc. of ICCE2010, pp.290-294.
- Kouta Sugihara, Takuya Osada, Shinsuke Nakata, Hideo Funaoi & Tsukasa Hirashima 2012): "Experimental Evaluation of Kit-Build Concept Map for Science Classes in an Elementary School", Proc. of ICCE2012, Main Conference E-Book, pp.17-24.
- Michael J(2001): In pursuit of meaningful learning, Proc. Advances in physiology education 2001; 25:145-58.
- Mohammad Alkhateeb, Yusuke Hayashi & Tsukasa Hirashima (2013): Experimental use of KB-map to support the reading comprehension of EFL, Proc. SIG-ALST-B301 2013; 68:1-5.
- Mohammad Alkhateeb, Yusuke Hayashi & Tsukasa Hirashima (2014): The effects of using Kit-Build method to Support Reading Comprehension of EFL, Proc. the 16th International Conference on Human-Computer Interaction (accepted).
- Neil Anderson (1999): Exploring Second Language Reading Issues and Strategies,
- Ngovo & Bernard L (1999): Study Strategies for Narrative Texts: PORPE and Annotation, Proc. Journal of Developmental Education, Vol. 23 Issue 2, pp 24-28
- Novak, J. D., & Gowin, D. B (1984): Learning how to learn. New York, NY: Cambridge University Press.
- Pasana Chularut & Teresa K. DeBacker (2004): The influence of concept mapping on achievement, self-regulation, and self-efficacy in students of English as a second language. Contemporary Educational Psychology 29 pp. 248–263
- Phatchara Phantharakphong & Suteera Pothith(2014):Development of English Reading Comprehension by Using Concept Maps.Social and Behavioral Sciences 116 497 – 501
- Polyxeni Manoli & Maria Papadopoulou (2012): Graphic Organizers as a Reading Strategy: Research Findings and Issues. Creative Education 2012. Vol.3, No.3, 348-356
- Rayner, Keith; Barbara Foorman, Charles Perfetti, David Pesetsky & Mark Seidenberg (2001): How Psychological Science Informs the Teaching of Reading. Psychological Science in the Public Interest 2 (2): 31–74.

Evaluating Augmented Reality for Situated Vocabulary Learning

Marc Ericson C. SANTOS^{a*}, Arno in Wolde LUEBKE^a, Takafumi TAKETOMI^a, Goshiro YAMAMOTO^a, Ma. Mercedes T. RODRIGO^b, Christian SANDOR^a, & Hirokazu KATO^a

^aInteractive Media Design Laboratory, Nara Institute of Science and Technology, Japan

^bAteneo Laboratory for the Learning Sciences, Ateneo de Manila University, Philippines

*chavez-s@is.naist.jp

Abstract: Augmented reality (AR) is an emerging technology for communicating learning contents. Several AR systems are designed for learning. However, studies that have investigated instructional strategies for applying AR are few. This investigation requires the implementation of prototypes that use state-of-the-art technology and sound learning theory.

In this work, we implemented two prototypes for learning Filipino and German words by first developing a handheld AR platform. These prototypes demonstrate situated vocabulary learning. Using our AR system, students can learn words related to their current environment. We assessed the quality of these prototypes by conducting usability evaluations. For the theoretical grounding, we leveraged on multimedia learning theory to design the content.

Through our handheld AR platform, we evaluated situated vocabulary learning by comparing our prototypes to a flash cards application. In the first evaluation, students scored significantly lower when using AR in an immediate post-test. However, this difference disappeared after taking into account the variability in usability scores via analysis of covariance. Taking account usability is fairer when comparing an emerging technology to traditional technology. Test scores were also not significantly different in a delayed post-test. In the second evaluation, although the post-test score and answering time of students did not differ, our results showed that they feel more satisfied and can keep their attention better when using AR. For the first time, we demonstrated situated vocabulary learning by using AR. Moreover, our preliminary study confirms the intuition that students can achieve the same score using AR, but with benefits such as ease in maintaining attention and increased satisfaction.

Keywords: augmented reality, mobile learning, situated cognition, vocabulary learning

1. Introduction

Augmented reality (AR) is an emerging technology in the field of computers in education (Wu et al., 2013). We provide a useful summary of AR prototypes applied to learning in our review (Santos et al., 2014). Researchers do not usually take advantage of the most important feature of augmented reality: showing the explicit relationship of the virtual content to objects found in the real world. As such, we implemented and evaluated this display interaction for situated vocabulary learning (Figure 1).

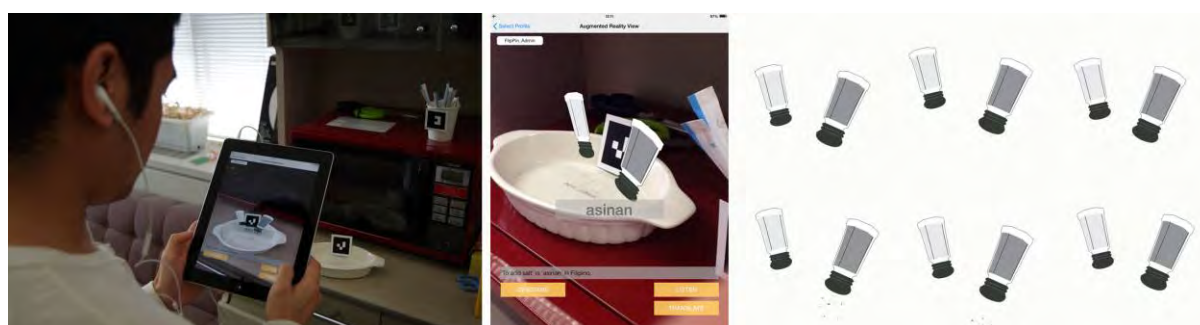

Figure 1. Situated Vocabulary Learning. Student (left) is learning the word “asinan,” the Filipino word for adding salt, on a dish inside a kitchen-like environment. Our interface (middle) integrates sprite animations (right) to explicitly illustrate the virtual action on a real object found in the environment.

In situated vocabulary learning, the physical environment is the context of the vocabulary. In this paper, we did a preliminary comparison of our approach (Figure 2) against a flash cards application which doesn't contextualize the vocabulary to the environment. For the first time, we evaluated usability, learning, and motivation in AR-based situated vocabulary learning.

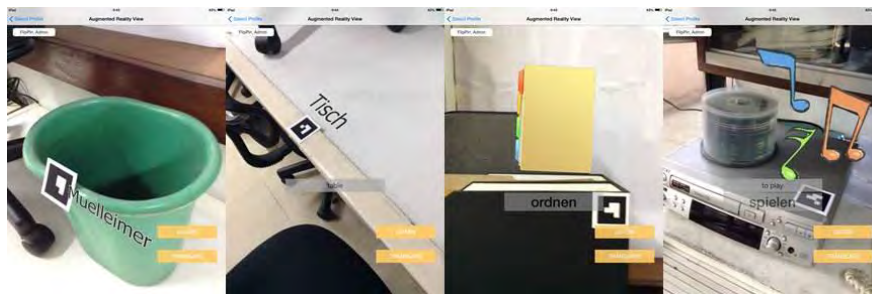

Figure 2. Nouns are displayed as labels, whereas verbs are shown as animations on real objects.

2. Related Works

People are familiar with AR because of the many AR browsers used to locate interesting places in the world (Grubert et al., 2011). People use AR browsers to see virtual labels and symbols integrated with a live video feed of the real environment. Thus, understanding location-related information, such as names of buildings, distances of restaurants, arrows for navigation, and so on, becomes easier. In our AR application, instead of displaying names and direction, our system displays the objects of nouns and illustrates the action of verbs.

Several AR systems have been developed for educational settings (Santos et al., 2014). One important work is Construct3D (Kaufmann et al., 2000; Kaufmann, 2002), which uses AR to teach students mathematics and geometry concepts. AR is suitable because students can interact naturally with three-dimensional shapes without the use of a mouse and keyboard. While wearing a head-mounted display, students can move around virtual shapes and perform operations on them. Moreover, the students see the same shape, thereby allowing them to work together on the target virtual object. Although Construct3D and other works take advantage of embodied cognition and collaborative learning, previous prototypes do not use the main feature of AR. AR, where “3-D virtual objects are integrated into a 3-D real environment in real time” (Azuma, 1997), displays the relationship of the virtual object to the real environment. In the present paper, we teach vocabulary by displaying the relationship between virtual objects and the real environment.

We can apply handheld AR to show the relationship of the educational content to the real environment. Handheld AR has gained attention in the field of educational technology because of its benefits such as ubiquitous learning (Dede, 2011), situated cognition (Specht et al. 2011), and collaboration (Li et al., 2011). Billinghurst and Duenser (2012) argue that handheld AR technology is mature for this application. AR software can already run on mobile phones equipped with fast processors, big display screens, data connection, built-in camera, and other sensors. Billinghurst and Duenser (2012) call for more interdisciplinary research to ground AR applications in learning theories. For our experiments, we designed the content of our AR prototype by applying the principles of multimedia learning theory (Mayer, 2009) and its related research.

2.1 Vocabulary Learning Systems Applying Various Contexts

People learn new words in meaningful contexts. Words are interpreted as a part of a passage of text. As such, Chen et al. (2013) proposed hypertext annotations for supporting quick definitions when reading electronic text. To support vocabulary learning, many other interfaces leverage on constructing various other contexts such as word games (Lin et al., 2008), virtual environments (Pala et al., 2011), collaboration (Joseph et al., 2005), and interaction with robots (Wu et al., 2008).

A natural context for learning vocabulary would be the physical environment. As such, Edge et al. (2011) and Dearman & Truong (2012) propose to present words that are related to the student's environment. Their systems involve the use of handheld devices and GPS positioning to detect the

student's current environment and then present words that are related to that environment. In both systems, the students browse the words on the device screen. We extended these works by using AR to display content onto the physical environment. In our AR system, the vocabularies are either animations or labels on real objects as shown in Figure 2.

2.2 Systems for Situated Vocabulary Learning

Liu's (2009) HELLO system demonstrated how handheld devices can be designed to promote significantly better learning outcomes. The HELLO system uses the campus network to deliver content for an English language learning system. It can detect the location of the user through QR codes spread around the school. At each location, students practice conversations with a virtual tutor on the device. In the user testing phase involving 64 students, Liu reported that students who used their system scored higher compared with those who used printed materials and audio recordings. This effect is attributed to practicing English in situations that could really happen in specific locations.

Beaudin et al. (2007) employed a different strategy to teach Spanish. For their research, they built a smart home learning environment that can detect user movements and intentions by using various sensors. Equipped with a mobile device, the smart home can identify who the user is and present relevant information. For example, they implemented a feature wherein voice-overs of Spanish words or phrases are triggered when users touch specific objects. This interaction makes an explicit connection between the Spanish content and the objects found in the learner's environment, thereby promoting situated cognition. Both the works of Liu and Beaudin et al. take advantage of near-transfer, that is, applying knowledge learned in a particular situation to another situation that is almost similar in context (Dunleavy & Dede, 2014). Combining ideas from these prototypes, we implemented a handheld AR platform (Section 3) to present contextual texts, images, and sounds in the real-world environment.

2.3 Multimedia Learning Applied to Vocabulary Learning

In multimedia learning theory, multimedia refers to pictures and words (both written and spoken). This theory assumes three things, namely, dual-channels, limited capacity, and active processing (Mayer, 2009). First, multimedia learning takes advantage of the two separate channels for perceiving visual and auditory information. Second, it recognizes that individuals have a limited capacity of information that they can attend to. Lastly, learning only takes place if the learner actively processes incoming information by connecting them to prior knowledge.

Given that individuals have a limited capacity of information that they can attend to, Lin and Yu (2012) investigated the cognitive load induced by different types of media presentations on a mobile phone. In their study with 32 eighth graders, they investigated the use of four multimedia modes, namely, text, text with audio, text with picture, and text with audio and picture. They discovered that the multimedia mode does not have a significant effect on vocabulary gain and retention. However, the learners rated the combined text-audio-picture as the mode that induced the least cognitive load.

Lin and Wu (2013) investigated the use of these four multimedia modes in a succeeding study with 423 junior high school students. They did not find any significant differences in vocabulary recognition nor in any interaction between multimedia mode and learning style preferences of the student. However, the participants who used text with audio and picture performed best in listening tests followed by the text with sound group. This result confirmed the intuition that audio annotations contribute to the construction of phonological knowledge of words and then applying this knowledge in listening to sentences. More importantly, they reported that the learning effects of the audio were maintained for two weeks with minimal attrition. Based on these works, we implemented features in our AR platform (Figure 3) to allow users to access text, audio, and pictures during the learning scenario.

In a separate study with 121 senior high school students, Lin and Hsiao (2011) studied the effects of the use of still images against simple animations in vocabulary learning. Their results showed that the animation group performed significantly better in learning Chinese and English vocabularies compared with the image group. They recommended the use of animations to illustrate dynamic words and processes. Thus, to facilitate better understanding of vocabulary in our handheld AR platform, we included a feature where sprite sheet animations can be used. We found this feature to be a simple solution to illustrate verbs in our learning scenario.

3. Implementation

We created two AR applications for learning Filipino and German words in a real environment. We achieved this objective by first creating a handheld AR platform that can display any situated multimedia – images, animations, sound, and text displayed on a real environment (Figure 3). We then filled the platform with content for the situated vocabulary learning of Filipino and German words.

3.1 Handheld Augmented Reality Platform

Figure 3 shows the package diagram of our platform and the sample interface enabled by our platform. The main part of the platform is the Controller, which has access to learning contents, sensor (camera), and user inputs. The Controller receives the marker ID and camera view matrix from the Tracker and uses these information to specify the behavior of the on-screen display. The Tracker was built using ARToolkit, and the Renderer was built on OpenGL ES 2.04.

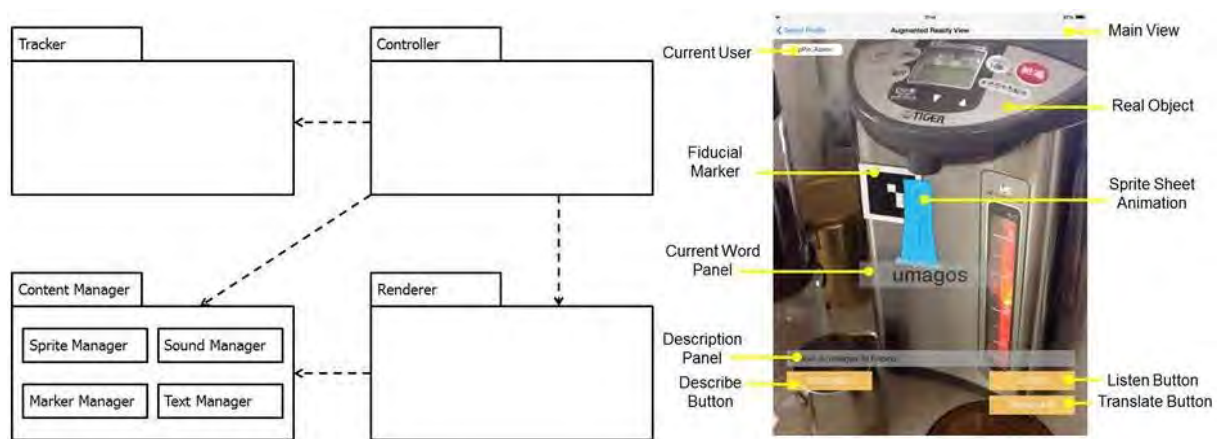

Figure 3. Package Diagram of Our Handheld Augmented Reality Platform (left); Sample Interface for Situated Vocabulary Learning (right)

We used the ARToolkit (Kato & Billinghurst, 1999) to measure the camera pose with respect to the target object. Markers in the video feed were located using the ARToolkit, which also outputs the marker's ID and the matrix representing the current view of the camera. The image was transformed to the correct view using the matrix, and then it was rendered accordingly using OpenGL ES 2.04.

The platform runs entirely on iPad tablets. For our experiments, we used the iPad 2 (dual-core A5, 512MB DDR2 RAM, 32GB, 601 g, 9.7 in display, 1024-by-768 at 132 ppi), and the iPad mini (64-bit A7, 512MB DDR2 RAM, 16GB, 331 g, 7.9 in display, 1024-by-768 at 163 ppi). The platform works with fiducial markers (Figure 3) to determine the target object and the viewing angle of the tablet's back camera. We used the back camera set to 640x480 pixels at 30 fps to sense the marker and to provide a video feed. After identifying the marker, the platform loads the corresponding audio, text, and image. Audio and text can be accessed using buttons (LISTEN, TRANSLATE, DESCRIBE). The images can either be still images or sprite sheet animations (Figure 3; Figure 1). The images are transformed depending on the camera view and are inserted in the video feed to suggest 3-D registration, that is, to give an impression that the graphics co-exist with the real objects.

3.2 Situated Vocabulary Learning Content

We used the platform to construct two situated vocabulary learning systems: one for 30 Filipino words and the other for 10 German words. We based the design of the content from previous works (Lin & Hsiao, 2011; Lin & Yu, 2012; Lin & Wu, 2013) by using a combination of text, audio, images, and animations as content. The text data are the vocabulary, its translation in English, and the description of the scene (only for the Filipino version). The audio data is the proper pronunciation of the vocabulary as spoken by a native speaker. The image data are text labels, images, or labels, as shown in Figure 2.

4. Experiments

We explored the strengths of our AR applications for situated vocabulary learning over its non-situated counterpart (Figure 4) in two preliminary experiments. Through these experiments, we aim to evaluate the use of AR for viewing vocabulary content that is situated in the real environment. We compared the AR applications to a non-situated version which is a tablet application that mimics flash card interaction. Our comparison does not employ any kind of special instructional design such as game mechanics and collaborative learning. As summarized in Table 1, users simply point the tablet PC to objects found in their environment when using our AR application. On the other hand, the flash cards application allows the user to flip through contents by pressing either next or previous.



Figure 4. Non-situated version of the AR applications.

Table 1. Comparison of Two Interfaces for Vocabulary Learning

	Situated (AR app)	Non-situated (Flash cards app)
Interaction	Users find an object with a marker. They then point the tablet PC to the marker to reveal the content.	Users press “next” or “previous” to switch between contents.
Inherent Feature	Users can see the markers in their environment even when they are not studying.	Users can quickly go through all the material because they are arranged in a series.
Visual Display	Images and animations are displayed on the real environment.	Static illustrations are shown on a white background.
Place and Time	Users can only use it inside their laboratory at any time.	

We considered inherent features of the interaction as part of the treatment. Thus, interventions were not done to control it. For example, one advantage of an AR learning system is that the students see the objects in their surroundings even when they are not studying. We imagine this feature to trigger unintended rehearsal of the vocabulary, thereby improving learning. This unintended rehearsal is part of AR learning; thus, we did not control this aspect. We did not forbid the students in the situated treatment from visiting the study place when they are not studying.

Another inherent feature is that students tend to cover all the vocabularies several times in one study session when flash cards are used. The flash cards are serially arranged, and students try to go through all the content two to three times in one sitting. Even if this is the case, interventions were not made because it is an inherent feature of the use of flash cards. Moreover, advising the students who use the AR application to view all the content several times will interrupt their natural learning style.

For our experiments, we controlled both location and time constraints. All of our students were only allowed to use the applications inside their respective laboratories. However, the applications are available to them at any time they want to study on that day. Given these features, we had seven hypotheses which we tested for significance in the 0.05 level via student’s t-test and analysis of covariance (ANCOVA). The hypotheses are as follows:

- H1. Students will perform better in an immediate post-test with non-situated vocabulary learning.
- H2. Students will perform better in a delayed post-test with situated vocabulary learning.
- H3. Students will rate situated vocabulary learning as a more motivating instructional material.
- H4. Students will maintain their attention better with situated vocabulary learning.

- H5. Students will find the contents of situated vocabulary learning as more relevant to them.
- H6. Students will feel more confident with non-situated vocabulary learning.
- H7. Students will feel more satisfied with situated vocabulary learning.

4.1 Experiment 1: Learning Thirty Filipino Words in Five Days

We adapted a between-groups approach with 31 participants (26 male, 5 female, aged 23–42, information science graduate students) to test our application for studying Filipino words. The first languages of the participants are Japanese (13), Chinese (5), Portuguese (3), German, English, Turkish, Bosnian, Indonesian, Finnish, Arabic, Spanish, Nepali, and Wolof. In our experiments, we divided the people into the treatment groups with consideration to the distribution balance of their first languages.

Eighteen participants were recruited from one laboratory. We set up our system inside their laboratory (Figure 5) so that they can learn words related to their refreshment area. All of them have experienced using an AR application before. As such, AR is not a novel technology for them.

Twelve participants from three laboratories were asked to use the non-situated version. Similar to the situated group, the non-situated group have used AR before and they are familiar with other novel interfaces. We distributed tablet computers to them with the flash cards application installed.



Figure 5. Refreshment area with markers (left), Learner using situated vocabulary learning (middle), Learner using non- situated vocabulary learning (right)

The participants used the assigned application for a recommended duration of 10–15 min per day for five days. The situated version was used inside a refreshment area with a maximum of four people using the application at the same time (Figure 5). On the other hand, the learners used the non-situated version wherever they went inside their laboratory office.

In this experiment, we evaluated the participants' learning outcomes and the usability of the application. On the fifth day, the participants answered the System Usability Scale (SUS) to measure the perceived usability of the applications (Lewis & Sauro, 2009). They then immediately took a post-test. After 12–14 days, they took a delayed post-test. The immediate post-test (27 items) and delayed post-test (24 items) consists of questions on recognizing the word in a multiple choice question, recalling the translation of the word, and guessing which word fits in different contexts.

4.2 User Testing 2: Learning German Words

We adapted a within-subjects design with 14 participants (8 male, 6 female, aged 17–20, science majors) to test the application for learning 20 German words (10 situated and 10 non-situated). Each participant used the situated and non-situated versions for a maximum of 8 min. Seven used the situated version first, whereas the other seven used the non-situated version first to balance any effect of the ordering of the treatment. For the situated version, the learners viewed the content on a small area around a laboratory technician's desk. The markers are placed near each other in a small area to minimize the time spent transferring from one object to another. This is important because we wanted to observe the study time of the students. For the non-situated version, they used the application while sitting inside the same room.

The students are then asked to answer 10 multiple choice questions that test their skill to recognize a word. Aside from logging the answer, we also logged the time it took for the learner to

answer the question. After taking the quiz, the participants also answered a subset of the Instructional Materials Motivation Questionnaire or IMMS. We picked 30 questions that are applicable to our system out of the 36 questions listed in the work of Huang et al. (2006). IMMS models the extent of motivation one gets from an instructional material by using the ARCS model (Attention, Relevance, Confidence, and Satisfaction). This model has been applied to AR instructional materials by Di Serio et al. (2013).

5. Results and Discussion

Our experiments involved a small sample size, thus the results should be interpreted with caution. These should be replicated with a bigger sample size. Nevertheless, these results can guide future design of AR applications and experiments in situated vocabulary learning with AR. In our experiments, no significant differences were observed in learning outcomes between situated and non-situated vocabulary learning. However, students report better attention and satisfaction in using our system. We found evidences that support hypotheses H4 and H7 but not H1–3 and H5–6.

5.1 Experiment 1: No significant difference in usability and learnability

We computed the SUS score and its factors from the participant responses in Experiment 1. The results in Table 2 show that the AR application has an SUS score of 74%, which is close to its flash cards application counterpart with 80%. According to Sauro (2011), both interfaces are above average (68%); thus, they are both good interfaces. Moreover, the results in Table 3 show that our participants did not have difficulty in learning these new interfaces.

We did not find a significant difference between the two interfaces. As such, using these interfaces to compare situated and non-situated vocabulary learning is reasonable. We achieved a good usability score because we applied previous research in multimedia learning. Furthermore, our current interface features are minimal, and the study task is simple.

Table 2. System Usability Scale Scores for Situated and Non-Situated Vocabulary Learning

	Application	N	Mean	Standard Deviation	T value
SUS Score	AR	18	74%	12%	1.64
	Flash cards	13	80%	6%	

Table 3. Factors of the System Usability Scale Scores

Factor	Application	N	Mean	Standard Deviation	T value
Usability	AR	18	70%	14%	1.50
	Flash cards	13	76%	7%	
Learnability	AR	18	90%	13%	1.53
	Flash cards	13	96%	5%	

5.2 Experiment 1: Significantly higher score with non-situated for immediate post-test but not for the delayed post-test

Table 4 is a summary of the results of the immediate and delayed post-tests in Experiment 1. In the immediate post-test, the non-situated group scored significantly higher with a moderate effect ($d = 0.75$) than the situated group. The breakdown in Table 5 shows that the situated group scored lower than the non-situated group in all types of questions. This result is indicative of an overall inferior mastery of content rather than a weakness in a particular question type.

In most practical cases, people do not apply their learning immediately after studying. Rather, they would use their knowledge after a few days, either for a test or to apply it to a new lesson. As such, the delayed post-test is a more important point of comparison for learning than the immediate post-test. After 12–14 days, the significant difference in learning disappeared (Table 4).

Table 4. Total Scores in Immediate and Delayed Post-tests

Post-test	Group	N	Mean	Standard Deviation	T value
Immediate	Situated	18	71%	20%	2.14*
	non-situated	13	86%	20%	
Delayed	Situated	12	68%	23%	0.31
	non-situated	13	70%	18%	

*p < 0.05

Table 5. Immediate Post-test Scores for Each Question Type

Type	Group	N	Mean	Standard Deviation	T value
With illustrations	situated	18	87%	12%	0.99
	non-situated	13	92%	20%	
Recognizing Filipino with choices	situated	18	80%	15%	2.54**
	non-situated	13	94%	15%	
Recognizing Filipino without choices	situated	18	64%	30%	1.95*
	non-situated	13	83%	24%	
Translating from English to Filipino	situated	18	55%	31%	2.54**
	non-situated	13	81%	23%	
Transfer of word usage with choices	situated	18	75%	19%	2.40*
	non-situated	13	91%	16%	

*p < 0.05, **p < 0.01

5.3 Experiment 1: No Significant Differences in Immediate Post-test Scores After Considering Usability as Covariant in ANCOVA

If both AR and flash card applications have the same SUS score, then we could do the fairest comparison possible. However, despite our best efforts, a small difference of six SUS points was still observed between the two groups. We conducted ANCOVA to take into account this difference in quality. We assume that the quality of the implementation of the interface affects the students' scores.

ANCOVA was conducted because the difference in SUS score is not significant. We also checked the homogeneity of variance using the Levene's test. The results of the Levene's test showed that no significant differences ($p > 0.05$) were observed. Thus, our data have homogenous variances. The ANCOVA results (Table 6) show that no significant differences were observed in the test scores of situated and non-situated group for both immediate and delayed post-tests. We guess that if we can improve our AR application to the same level as the flash card application, then students can perform equally well with a novel interface.

Table 6. Analysis of Covariance of Post-Test Scores with System Usability Scale Score as Covariant

Test	Group	N	Mean	Standard Deviation	Adjusted Mean	F value	p value
Immediate	situated	18	71%	20%	72%	3.02	0.09
	non-situated	13	86%	20%	85%		
Delayed	situated	12	68%	20%	69%	0.00	1.00
	non-situated	13	70%	16%	69%		

5.4 Experiment 2: No significant difference in Post-test and Motivation, but significantly better Attention and Satisfaction with Situated Vocabulary Learning

No significant differences were observed in the immediate post-test between situated ($m = 94\%$, $sd = 8\%$) and non-situated ($m = 95\%$, $sd = 8\%$) vocabulary learning. On the average, the non-situated group answered our multiple questions faster ($m = 2.28$ s, $sd = 0.92$ s) than the situated group ($m = 2.60$ s, $sd = 1.03$ s) for each question. However, this difference was not significant.

Experiment 2 focuses on evaluating motivation by using the ARCS model. Although two interfaces can arrive at the same learning result, performance in tests should not be the only measure of success in creating interfaces. User experience is another important consideration. As such, we also evaluated the interfaces in terms of its ability to motivate students to learn.

Overall, no significant difference was observed in the IMMS rating of situated and non-situated vocabulary learning (Table 7). However, looking at the factors of the IMMS (Table 8), significant differences were observed in the attention and satisfaction factors. The students report that the AR application catches and holds their attention more than the flash cards. Moreover, they report higher satisfaction with their learning experience. The learners were slightly more confident to use flash cards probably because it is a more familiar interface. The learners rated AR to be higher in relevance by five points, which is attributed to the implicit connection between learning contents and real environment. However, no statistical significance was observed for the relevance and confidence factors.

Table 7. Instructional Material Motivation Survey Scores for Situated and Non-situated Scenarios

	Treatment	N	Mean	Standard Deviation	T value
Motivation Score	situated	14	76%	12%	1.34
	non-situated	14	71%	11%	

Table 8. Factors of the Instructional Material Motivation Survey Scores

Factor	Treatment	N	Mean	Standard Deviation	T value
Attention	situated	14	75%	14%	1.84*
	non-situated	14	65%	14%	
Relevance	situated	14	74%	14%	0.97
	non-situated	14	69%	13%	
Confidence	situated	14	80%	12%	0.74
	non-situated	14	83%	8%	
Satisfaction	situated	14	77%	16%	1.71*
	non-situated	14	66%	18%	

*p < 0.05

6. Conclusion

We are the first to use AR for explicitly displaying the relationship between vocabulary learning contents and real world environment for situated vocabulary learning. This preliminary study supports our intuition that AR can enable the same knowledge acquisition with added benefits of better attention and satisfaction. We did not employ special instructional strategies in our experiments such as game mechanics or collaboration between students. As such, the differences in the learning experience are attributed to the inherent advantages or disadvantages of the interfaces: augmented reality and flash cards representing situated and non-situated vocabulary learning, respectively.

Our system can be improved by applying other learning theories and instructional strategies that are not possible for traditional interfaces. Currently, we applied multimedia learning theory because AR is essentially a presentation medium. In the future, we can apply insights on location-based games and collaborative learning to create better augmented reality learning experiences.

References

- Azuma, R. T. (1997). A survey of augmented reality. *Presence*, 6(4), 355-385.
- Beaudin, J. S., Intille, S. S., Tapia, E. M., Rockinson, R., & Morris, M. E. (2007). Context-sensitive microlearning of foreign language vocabulary on a mobile device. In *Ambient Intelligence* (pp. 55-72). Springer.
- Billinghurst, M., & Duenser, A. (2012, July). Augmented Reality in the Classroom. *Computer*, 45(7), 56-63.
- Chen, I., Yen, J. C., & others. (2013). Hypertext annotation: Effects of presentation formats and learner proficiency on reading comprehension and vocabulary learning in foreign languages. *Computers & Education*, 63, 416-423.

- Dearman, D., & Truong, K. (2012). Evaluating the implicit acquisition of second language vocabulary using a live wallpaper. *Proceedings of the 2012 ACM annual conference on Human Factors in Computing Systems*, (pp. 1391-1400).
- Dede, C. (2011). Emerging technologies, ubiquitous learning, and educational transformation. In *Towards Ubiquitous Learning* (pp. 1-8). Springer.
- Di Serio, A., Ibanez, M. B., & Kloos, C. D. (2013). Impact of an augmented reality system on students' motivation for a visual art course. *Computers & Education*, 68, 586-596.
- Dunleavy, M., & Dede, C. (2014). Augmented reality teaching and learning. In *Handbook of research on educational communications and technology* (pp. 735-745). Springer.
- Edge, D., Searle, E., Chiu, K., Zhao, J., & Landay, J. A. (2011). MicroMandarin: mobile language learning in context. *Proceedings of the SIGCHI Conference on Human Factors in Computing Systems*, (pp. 3169-3178).
- Grubert, J., Langlotz, T., & Grasset, R. (2011). *Augmented reality browser survey*. Tech. rep., Institute for Computer Graphics and Vision, University of Technology Graz.
- Huang, W., Huang, W., Diefes Dux, H., & Imbrie, P. K. (2006). A preliminary validation of Attention, Relevance, Confidence and Satisfaction model-based Instructional Material Motivational Survey in a computer-based tutorial setting. *British Journal of Educational Technology*, 37(2), 243-259.
- Joseph, S., Binsted, K., & Suthers, D. (2005). PhotoStudy: Vocabulary learning and collaboration on fixed & mobile devices. *Wireless and Mobile Technologies in Education, 2005. WMTE 2005. IEEE International Workshop on*, (pp. 5--pp).
- Kato, H., & Billinghurst, M. (1999). Marker tracking and hmd calibration for a video-based augmented reality conferencing system. *Augmented Reality, 1999.(IWAR'99) Proceedings. 2nd IEEE and ACM International Workshop on*, (pp. 85-94).
- Kaufmann, H., Schmalstieg, D., & Wagner, M. (2000). Construct3D: A Virtual Reality Application for Mathematics and Geometry Education. *Education and Information Technologies*, 5(4), 263-276. Retrieved from <http://dx.doi.org/10.1023/A%3A1012049406877>
- Lewis, J. R., & Sauro, J. (2009). The factor structure of the system usability scale. In *Human Centered Design* (pp. 94-103). Springer.
- Li, N., Chang, L., Gu, Y. X., & Duh, H. B. (2011, July). Influences of AR-Supported Simulation on Learning Effectiveness in Face-to-face Collaborative Learning for Physics. *Advanced Learning Technologies (ICALT), 2011 11th IEEE International Conference on*, (pp. 320-322).
- Lin, C. C., & Hsiao, H. S. (2011). The Effects of Multimedia Annotations via PDA on EFL Learners' Vocabulary Learning. *Proceedings of the 19th International Conference on Computers in Education*.
- Lin, C. C., & Wu, Y. C. (2013). The Effects of Different Presentation Modes of Multimedia Annotations on Sentential Listening Comprehension. *Proceedings of the 21th International Conference on Computers in Education*.
- Lin, C. C., & Yu, Y. C. (2012). EFL Learners' Cognitive Load of Learning Vocabulary on Mobile Phones. *Proceedings of the 20th International Conference on Computers in Education*.
- Lin, C. P., Young, S. C., & Hung, H. C. (2008). The game-based constructive learning environment to increase English vocabulary acquisition: Implementing a wireless crossword Fan-Tan game (WiCFG) as an example. *Wireless, Mobile, and Ubiquitous Technology in Education, 2008. WMUTE 2008. Fifth IEEE International Conference on*, (pp. 205-207).
- Liu, T. Y. (2009). A context-aware ubiquitous learning environment for language listening and speaking. *Journal of Computer Assisted Learning*, 25(6), 515-527.
- Mayer, R. E. (2009). *Multimedia learning*. Cambridge university press.
- Pala, K., Singh, A. K., & Gangashetty, S. V. (2011). Games for Academic Vocabulary Learning through a Virtual Environment. *Asian Language Processing (IALP), 2011 International Conference on*, (pp. 295-298).
- Santos, M., Chen, A., Taketomi, T., Yamamoto, G., Miyazaki, J., & Kato, H. (2014, March). Augmented Reality Learning Experiences: Survey of Prototype Design and Evaluation. *Learning Technologies, IEEE Transactions on*, 7(1), 38-56.
- Sauro, J. (2011). Measuring usability with the system usability scale (SUS). *Measuring usability with the system usability scale (SUS)*. Retrieved from <http://www.measuringusability.com/sus.php>
- Specht, M., Ternier, S., & Greller, W. (2011). Mobile augmented reality for learning: A case study. *Journal of the Research Center for Educational Technology*, 7(1), 117-127.
- Wu, C. C., Chang, C. W., Liu, B. J., & Chen, G. D. (2008). Improving vocabulary acquisition by designing a storytelling robot. *Advanced Learning Technologies, 2008. ICALT'08. Eighth IEEE International Conference on*, (pp. 498-500).
- Wu, H. K., Lee, S. W., Chang, H. Y., & Liang, J. C. (2013). Current status, opportunities and challenges of augmented reality in education. *Computers & Education*, 62, 41-49.

System Design for Academic Listening of Second Language Based on Strategy Object Mashups Approach

Hangyu LI^{a*}, Shinobu HASEGAWA^b

^a*School of Information Science, Japan Advanced Institute of Science and Technology, Japan*

^b*Center for Graduate Education Initiative, Japan Advanced Institute of Science and Technology, Japan*

*lihangyu@jaist.ac.jp

Abstract: Most foreign students studying abroad lack of effective academic listening ability which is considered to be essential for them to achieve their academic successes. Moreover, as listening comprehension ability is also considered to be the most difficult to improve in contrast with the other three (Reading, Speaking and Writing), the purpose of this research is to support the training of academic listening skills for students pursuing academic success in a foreign educational institute. We have identified several learning strategies proved to be effective for cultivating academic listening skills from related work and built up the respective strategy models. Based on the established strategy models, we are now in the process of designing and developing various strategy objects (function units), so as the mashups environment where these objects can be assembled and operated. Unlike previous learning systems that provided identical functions to the learners, this research is expected to provide the learners with self-adjustable learning environment by putting together various strategy objects provided. We also attach semantic meanings (listening strategies and tactics) to each object to improve the metacognitive awareness of strategy application of the learners, for the effectiveness in listening practice as proved in past studies. Furthermore, a feedback agent is to be implemented to recommend proper strategy objects to the learners based on their learning situations. As a result, the learners are expected to be able to: practice their listening under an adaptive learning environment, strengthen their metacognitive awareness of the strategy application, and adjust their learning environment constantly with the support of the feedback agent or through peer reviews.

Keywords: Academic Second Language, Listening Strategy, Strategy Objects, Strategy Object Mashups

1. Introduction

Among the other language skills (Reading, Writing and Speaking), academic listening poses serious challenges to F/SL (Foreign, Second Language) learners. Even for students with high level of proficiency and being comfortable with everyday listening and conversation, listening tasks encountered in academia still seem formidable (Mason, 1995). Academic listening is complex, multi-faceted process that places enormous skill demands on the listener (Richards, 1983). Since researches have shown that effective academic listening comprehension skills are essential for the students to achieve academic success (Benson, 1994; Dunkel, 1991; Vandergriff, 2004), studies focusing on this subject are actively conducted worldwide. Among those, listening strategy is an important subject, which is playing an important part in improving listening skills (Goh, 1998). Evidence from various studies revealed that F/SL learners, regardless of skilled or unskilled, were all applying some listening strategies, consciously or unconsciously (Goh, 2002). Some of those researches have shown that the difference lies in what they are using and the way of using them (Smidt and Hegelheimer, 2004). Learners with higher listening ability tend to choose listening strategies more adaptive to their learning and put the chosen strategies into practice more effectively than the unskilled ones (Goh, 1998). Moreover, since what learners know about their learning can directly influence the process and even the outcome of it (Palmer and Goetz, 1988), it has been proved more than once the

importance of improving learners' metacognitive awareness of listening strategy through various experiments of related researches (Goh, 1998, 2008; Holden, 2004; Bozorgian and Pillay, 2013). Goh (2008) stressed in her findings that learners need to be aware of how their listening comprehension is affected by their choice of listening strategies to develop flexibility in the use of listening strategies as well as find suitable ways for systematic practice, ultimately be able to obtain listening skills. In order to address this issue, we proposed a strategy object mashups approach (Li and Hasegawa, 2014) which enables learners to practice their listening ability under the adaptive supporting functions while making them aware of their strategy applications and how would they affect their learning. Moreover, by attaching semantic meanings (listening strategies) to the different functions used by each individual, we also expect the perceivable comparisons of different functions used among the learners to take place, which leads to the possibility for the communication on learning techniques and methods. Therefore, unlike previous researches that provide fixed identical functions to the learners, we entitle the learners with the flexibility of building up their distinctive learning environment by putting together function units provided, along with the self-adjustment supported by peer-reviews and system recommendation. In this paper, we discuss this approach in further details and introduce the system design. The following sections are arranged like this: we firstly talk about the concept of listening strategy and the difficulties existing among F/SL learners trying to apply proper listening strategies into their practices, and secondly identify the requirements and purposes of this research, and then we introduce our research method called strategy object mashups approach along with the system design, and finally provide an overall view of the system Graphic User Interface (GUI).

2. Issue Addressed

2.1 Listening Strategy & Comprehension Tactics

In cognitive psychology, the term 'strategy' is linked to the conceptual framework of human learning and memory and refers to mental steps or operations carried out to accomplish cognitive tasks (Clark and Lisa, 2009). As a result, listening strategies are mental mechanisms carried out by second language learners to achieve reasonable comprehension when processing information contained in a large input of utterance, for they have to work under the constraints of an overloaded working memory, and a lack of linguistic, sociolinguistic and content knowledge (Call, 1985; Farch and Kasper, 1986; Goh, 2000). O'Mally and Charnot (1985) categorized listening strategy into three classifications: Metacognitive strategy, Cognitive strategy and Social strategy. Generally speaking, cognitive strategies are fundamental operations taken by the learners directly on their learning subject to obtain knowledge. Metacognitive strategies are concerned with how to learn or with learning to learn, involving with planning, monitoring and self-evaluation combined with the learning process. Social strategies are social behaviors learners conduct when communicating with others, and examples include asking skilled ones for advises, to compare notes and etc. The concept of comprehension tactics (which is referred as tactics in this paper) was brought up by Goh (1998). She defined tactics as individual mental techniques through which a general strategy is operationalized. Goh also identified that the tactics used for the same strategies vary from learner to learner, and skilled learners demonstrated better on strategy choices and the combination of appropriate tactics (Goh, 1998). In this research, we refer tactics as the learning procedures or processes when constructing strategy models, and also as the semantic meanings attached directly to the strategy object mashups of each learner, which will be explained in later sections. For the comprehension tactics are processions of understandable learning behaviors to operationalize listening strategies, it is possible to identify and organize comprehension tactics proved to be effective in academic listening, and then correspond these tactics to the according listening strategies under the classifications of the meta-cognitive, cognitive and social define by O'Mally (1989).

2.2 Difficulties in Applying Listening Strategies in Academia:

Although researchers in the field of linguistics have repeatedly proven the effectiveness of consciously adopting adaptive strategies in listening practice through various methodologies, there are several

difficulties for foreign students to successfully utilize proper listening strategies in most of the cases. Firstly, it is difficult to consciously put listening strategies into operation. Indeed, there are efforts having been put into teaching the techniques to insinuate the application of listening strategies (Hosseini, 2013), and the result of which was positive. However, in academic life in which foreign students often are pressed by hard schedules and mostly failed to attend such classes, self-directed learning is the main approach for practicing. As a result, they tend to resort to their inefficient accustomed way of practicing without being aware of what strategies they are using and how these strategies affect their learning. Secondly, it is difficult to flexibly adopt adaptive listening strategies. Factors including personal traits, motivation level and cognitive style may influence the strategy choice (Oxford and Nyikos, 1989). Because of their lacking of strategy knowledge and guidance from experts in strategy application, it is difficult to come up with an adaptive combination of listening strategies which suits the learners' characteristics and learning goals. Thirdly, it is difficult to put social strategies into practice. As for self-directed learning is the mainstream among foreign students to build up the necessary skills of the targeted language, it is considered inconvenient for them to get involved actively in communication or cooperation with like-minded people to ask help, exchange ideas and acquire advices. This leads to the missing of learning opportunity and sharing of knowledge.

2.3 Related work and Research Requirements:

Back in the late 80's, and early 90's, with the fast development of information technologies and the prevailing use of computer, CALL was breaking ground in the new technology frontier and began to draw attention. Up to now, numerous CALL systems have been developed to meet different requirements. Some of them are working as an additional supplement to the actual teaching courses known as blended learning (Wiki), which are not designed for self-directed learning and proved performing better in the combination of instructors' involvement (Li and Wang, 2012). Furthermore, for CALLs appropriated for self-directed learning, there are still some limitations. First of all, they did not pay attention on how to improve learners' metacognitive awareness of learning strategies. They provided the learners with sets of pre-designed supporting functions without explaining the reasons why those functions were introduced and how would they affect the learning. Secondly, the supporting functions provided to the learners were not adaptive to everyone, since the learners were offered with the identical learning environment. Despite of the fact that there are researches on the adaptive learning system actively conducted throughout the years, most of them focused on the adaptation from the viewpoint of learning materials, not the learning functions (Yang, Hwang, Chiang and Yang, 2013; Wang and Mendori, 2013; Fisser and Strijker, 2014:). In those researches, learners were not in the position of choosing or adjusting system functions to meet their individual learning needs. Thirdly, they are not providing enough support to take social strategies into account, which causes the lack of communication among the learners themselves. There have been studies such as the one on enabling limited sharing and peer-reviews on learning outcomes (Ogata and Yano, 2004), the learning techniques of each learner and the strategy application are not the focuses to be represented in a universally recognizable way.

Having considered these limitations existing in current CALL systems, and in order to address the difficulties encountered by foreign students described in section 2.2, we come up with three corresponding requirements, which if satisfied, are assumed to be able to improve the current learning situation for self-directed listening practice. These requirements are:

1. A learning environment where not only effective supporting functions are provided but also the strategic meaning of each function are provided in order to improve the awareness of strategy application.
2. The flexibility of adjusting the supporting functions in the learning environment by the learners themselves according to their own characteristics and learning needs.
3. A more effective communicative platform where not only the sharing of established knowledge can take place, but also the learning techniques and strategy applications of each learner can be perceived and communicated, while probably leading to the proper adjustments to their learning environment.

Aiming to effectively address these requirements, this research intends to design and develop a self-directed and community-based learning environment with the main purposes of: making the learners aware of strategy application, helping them build up adaptive learning environments, and

enabling them to communicate on not only leaning resources and knowledge but also on learning strategies and techniques. We expect the learners to learn and improve their learning skills through: the strengthened metacognitive awareness of their strategy application; the process of building up their adaptive learning environments which will be constantly adjusted by themselves from peer-reviews and system recommendation; and the awareness of the relationships between their learning activities and the according listening strategies.

3. Approach

3.1 Concept of Strategy Object Mashups Approach:

Figure 1 describes the concept of this approach. Strategy models are learning procedures or processes commonly adopted to execute listening strategies. Based on the established strategy models systematized from listening strategies that have been proved to be effective for cultivating academic listening skills, the respective function units, which are referred as strategy objects in this paper, can be developed. The learners are expected to choose their interested strategy objects to compose their personal distinctive learning environment that we refer as strategy object mashups in this paper. In this approach, there is also a social strategy platform implemented to support the communication not only on learning knowledge but also on strategy object mashups, which can be perceived as peer reviews on learning techniques. As the learners are building and adjusting their learning environment, a feedback agent collects and analyzes all strategy object mashups created by everyone to recommend the learners with more appropriate strategy objects for the proper functional adjustment according to their features and learning goals.

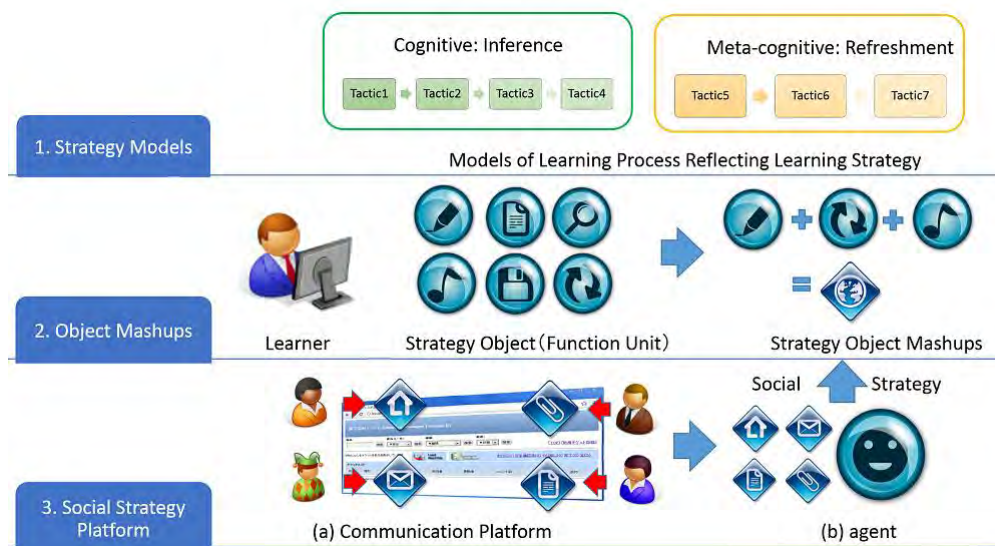

Figure 1. The Concept of Strategy Object Mashups Approach.

3.2 Ontology-driven Multi-layer Map Model:

Considering the three requirements described in section 2.3, the relationships among strategies, tactics and the learning environment need to be created in order to ensure every strategy object be traced to its according tactics and strategies. For this reason, we have designed the system model in an ontological manner. A multi-layer model is a core of this learning environment and intended to perform as a GUI for self-directed S/FL learners for self-directed and community-based listening practice. Figure 2 shows the model, which possesses of four layers. The object layer is where the system presents all the strategy objects for the learners to choose and assemble. Also, the detailed description of each object will also be provided to the learners to help them make reasonable choices. The learners choose their wanted objects and the system assembles the selected ones into strategy object mashups on the upper layer where

basically, the learners conduct their listening practice while making references to the mashups of others if necessary. The tactic layer is where to display the tactics being adopted based on the learners' object mashups, by putting together the tactics traced from the selected objects. And accordingly, the listening strategy operationalized by the tactics can be found on the strategy layer. The upper two layers are meant to attach semantic meanings to object mashups of each learner, with the purpose of improving their metacognitive awareness of what listening strategies and tactics are being used and how they affect their learning. For example, if we assumed that one of the learners in Figure 3 picked the objects of "display comments of other people, "display background knowledge" and "input keywords", the chosen three objects are working together as object mashups to support the learning activity. By tracing the comprehension tactics related with the chosen objects, the tactic "inference from related background knowledge and comments of others and input keywords" is generated and so does the corresponding strategies which are inference and cooperation in this example. Basically, with this system, the learners are expected to be capable of: (A). Creating their personal mashups; (B). Referring to others' object mashups to make adjustment to their own; (C). Adjusting their personal mashups by the recommendation from feedback agent. As mentioned before, we have designed this model using ontological manner to connect these four layers, which will be explained in details later. The connections between layers are to be stored and analyzed by the feedback agent for the proper recommendation of the object mashups for the learner. Therefore, by using the proposed system, the learners would be able to assemble their personal object mashups by putting together proper objects, to refer to others' object mashups for possible adjustment of their own, and to take into account of the system's recommendation of new object mashups that could be more effective.

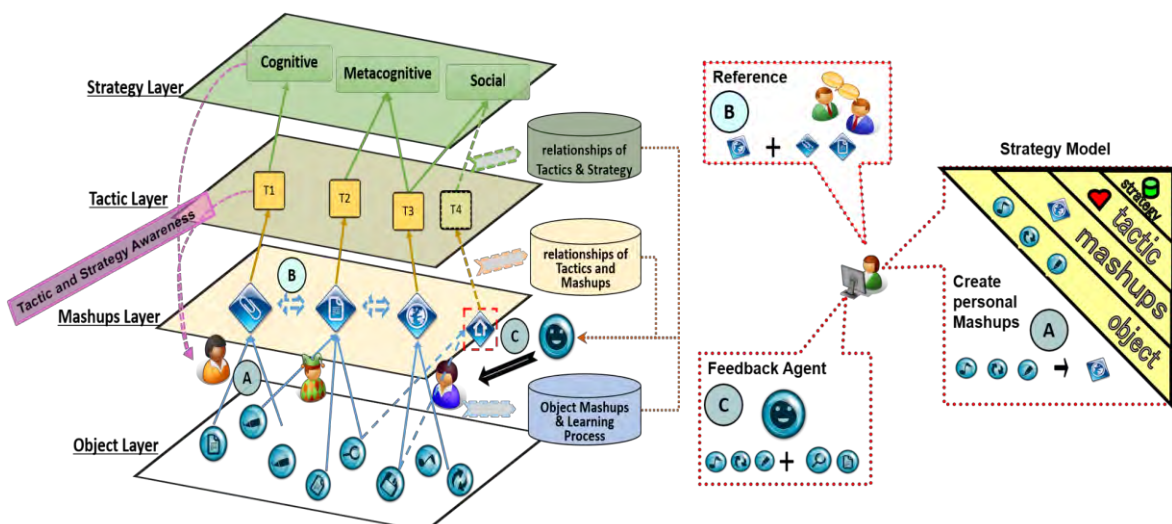

Figure 2. Multi-layer Model.

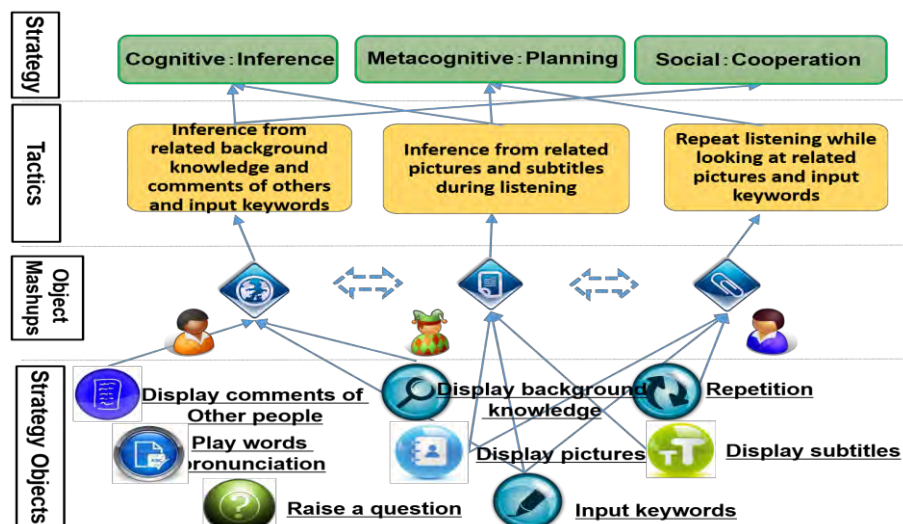

Figure 3. A Concrete Example of Multi-layer Model.

3.3 System Framework:

Figure 4 describes the framework of this system. At the beginning, a learner selects the listening materials, which in this research will be in the form of the lecture videos. And then, he/she will select the needed strategy objects to construct a distinctive personal listening environment. The next step would be practicing his/her listening and along the way, making adjustments to the learning environment. The learner can compare the mashups having been adopted by the other learners who have listened the current listening materials. Through the comparison of each other's application of object mashups, along with the attached tactics and listening strategies, the learner can adjust his/her own mashups and strengthen the metacognitive awareness of the strategy application of his/her own and the others. The strategy objects, comprehension tactics and listening strategies are managed by the system in an ontological manner which will be discussed in detail in the following section, to trace back the according tactics and strategies for the learner based on his/her choices of the strategy objects. Meanwhile, a feedback agent, as another aspect of this research, will be designed and developed to recommend proper object mashups to learners through the analysis of the mashups of the current learners and the ones who has listened the learning material, combined with the current learner's performance. In this way, we hope that the learners will be able to adjust constantly their learning environment through system recommendation and peer reviews and eventually, build up their listening skills in the process. As to the mechanism of this feedback agent, please refer to our published paper (Li and Hasegawa, 2014).

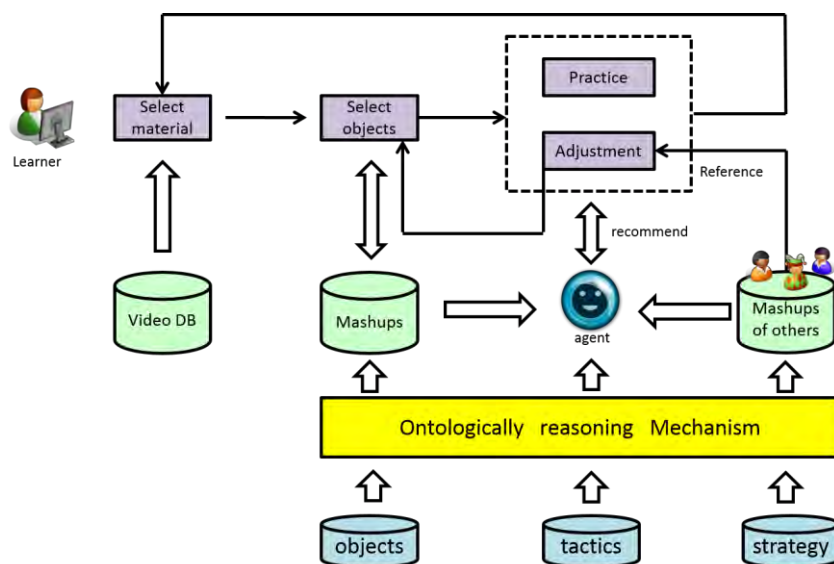

Figure 4. System Framework.

3.4 The Ontological Relationship among Strategy Model, Strategy Object & Strategy Object Mashups:

The ontological relationships between the listening strategy and the tactics are referred as the strategy models as shown in Figure 5. And then the strategy objects will be developed based on various established strategy models. In order to visualize each tactic into minimum-sized function units yet capable of being operated either alone or cooperatively, we take into account the actions learners usually take (See, Write and Listen) while doing listening practice, and then combine them into the strategy models. Because we intend to attach tactics and strategy to the object mashups composited by the learners, we relate the items of strategy, tactic, and strategy object and object mashups in an ontological manner as shown in Figure 5. The strategy models are expected not only to be able to represent the learning processes of different learners who uses diverse tactics for the execution of the same listening strategy, but also to be presented as the model of the intellectual activities with the applicable description for designing purpose. The following example better illustrates this ontological

mechanism by introducing several strategy models we have established along with the according tactics and strategy objects.

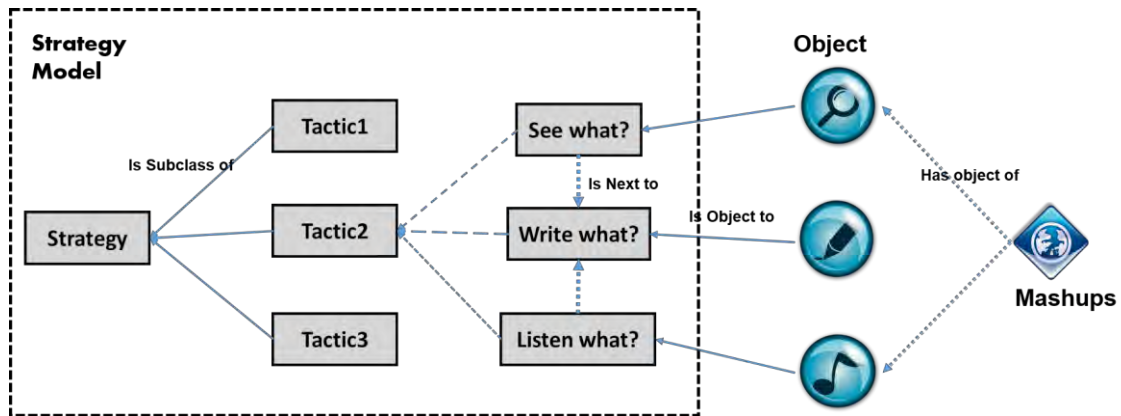

Figure 5. The Ontological Manner among Strategy Model, Strategy Object and Mashups.

Figure 6 shows partially the ontological mechanism of how we systematize the listening strategies into strategy models and how the strategy objects are being derived. All the listening strategies are subclasses of the three major categories whose relationships have been determined by O’Mally (1989). The tactics are the ones organized from various related researches that have been proved to have the positive effect on academic listening. In this figure, there is a typical cognitive strategy called ‘take note’. Ordinarily, to operationalize this strategy, we suppose the learners can summarize the important keywords from the transcript of a learning material beforehand or, they might want to dictate the whole transcript while checking the subtitles to monitor their accuracy. Hence, we identified these two tactics, which, by taking account of the learning actions the learners commonly take, are divided into learning procedures. For the former tactic, the learners first action would be seeing the transcript followed by writing important keywords from it, leading to existence of the objects ‘show transcript’ and ‘write down keywords’. As to the latter tactic, with the same process, we firstly conclude that the learners need to listen the learning material and then dictate all the content along the way, checking the subtitles constantly to correct their errors and collect knowledge. As a result, the objects needed would be listening to a video (we plan to use videos as the learning materials), writing transcript and seeing the subtitles. In this way, we expect, the strategy mashups composited by the learners can bear semantic meaning of tactics and strategies by being traced back the objects consisted of.

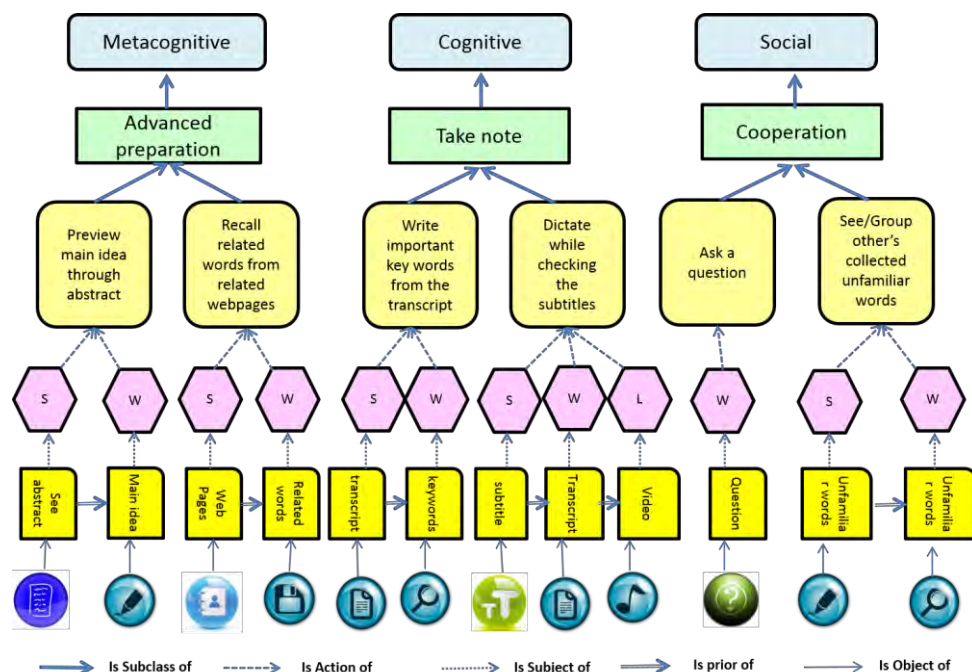

Figure 6. An Example of the Ontological Mechanism.

4. The Concept GUI of the Proposed System:

In this section, we will introduce the image of the system GUI and how learners would apply it in their self-directed learning for listening practice. As the pilot system is still under construction, please be noted that the graphs used below contain partially Photoshop-edited items in order to best illustrate the gist of the learning environment.

We have grouped all the developed strategy objects according to the action learners usually take from listening practice on the left side, so the learners are assumed to be able to quickly decide on their choices for strategy objects as long as they are sure of what to see, what/how to listen and what to write. Meanwhile, considering the fact that academic listening mainly takes the form as lecture-taking, it is considered reasonable to divide the phases of this process into pre-listening, on-listening and post-listening. Therefore, on the right side of the screen, there are these three listening phases into which the learners can drag and drop the objects they think might be helpful as shown in Figure 7. As some of the objects are not to be allowed to use in certain phrases (For example, all the objects related with audio control apparently are not appropriate for pre-listening), and some objects only work effectively in combination with certain others, and examples of this include that the objects for inputting (writing keyword, etc.) are of no meaning without being used together with objects like (display related pictures/abstracts, etc.), we will design the rules and reminding cues into the ontological mechanism to regulate object selection aiming to achieve maximum effectiveness.

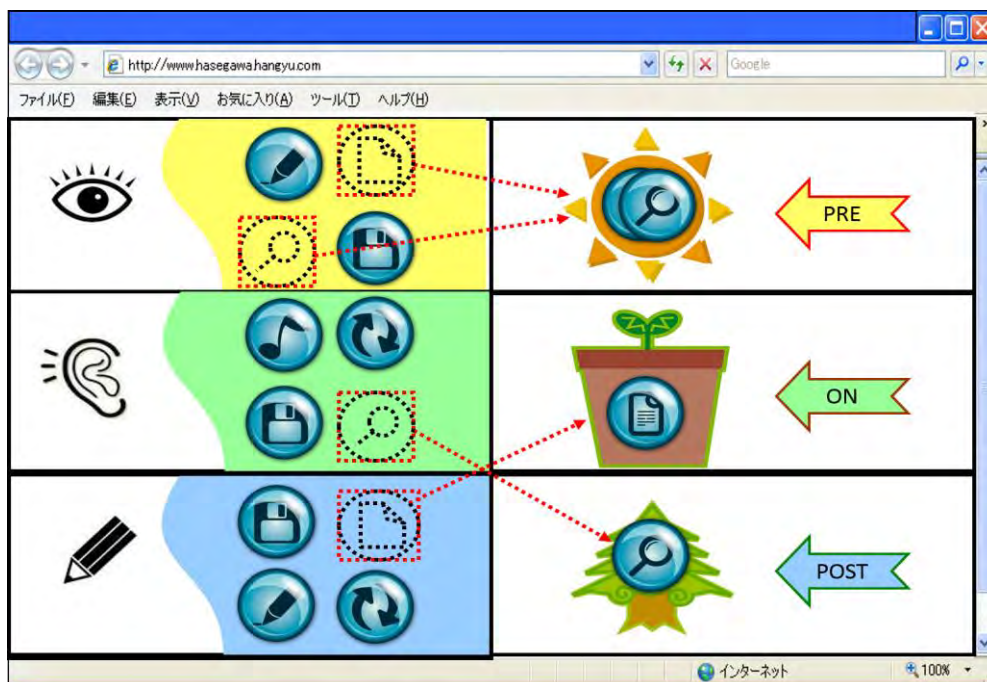

Figure 7. The Process of Building Strategy Object Mashups.

When the learners finish the process of building object mashups, they can begin their listening practice as shown in Figure 8. The training page is divided into two blocks. The right one is where the learners conduct their listening practice, which is consisted of multiple windows that respectively are the visualizations of the selected strategy objects. The learners can change the size of each window and drag and drop the selected ones into places they think fit. On the left side, the system presents the structures of object mashups of all the three phases in connection with the according tactics and strategies. The reasons for this GUI representation are, first of all, to help the learners improve their awareness of their strategy application by presenting the structure of the relationships between their object mashups and the according strategies and tactics; secondly, by navigating through objects across phrases, the learners will strengthen the connections between strategies and learning phases, which might lead to their proper operation of listening strategies and tactics in their real academic life.



Figure 8. An Example of GUI for the Phase of On-listening

5. Conclusions & Future Work:

This paper has designed the learning environment where the learners not only are able to construct adaptive supporting functions by putting together wanted strategy objects, but also to be aware of the corresponding comprehension tactics and listening strategies they are adopting and how are they affecting their learning with the purpose of improving their listening skills, through the ontological reasoning mechanism. Moreover, the learners are expected to learn through building up object mashups, which can be flexibly adjusted by the comparisons with that of others' and the recommendation from the system feedback agent. We believe this research might open the possibility of providing an adaptive learning environment for diverse learners and a more recognizable format for reference and communication on learning skills and methods in a virtual place.

In the near future, we firstly will continue our design and development of the strategy objects based on the established strategy models, so as the mashups environment as web services using Microsoft ASP.NET MVC. After finishing the pilot system, an evaluation will be conducted in our institute using the video archive of lectures, which contains all the courses in our department. We will firstly to make sure whether the learning effectiveness can be improved through building up object mashups, and secondly whether the adjustment of mashups positively affected by peer comparisons and from the system recommendation.

Acknowledgements

The work is supported in part by Grant-in-Aid for Scientific Research (C) (No. 26330395) from the Ministry of Education, Science, and Culture of Japan.

References

- Benson, M. J. (1994). Lecture listening in an ethnographic perspective. *J. Flowerdew, (ed), Academic listening: Research perspectives*, 181-198.
- Call, E. (1985). Auditory short-term memory, listening comprehension and the Input Hypothesis. *TESOL Quarterly, Vol.19, 4, 765-781.*

- Clark C., Lisa, C. (2009). Cognitive Strategy. *The Gale Group, Inc.*
<http://www.education.com/reference/article/cognitive-strategies/>
- Dunkel, P. (1991). Listening in the Native and Second/Foreign Language: Toward and Integration of Research and Practice. *TESOL Quarterly*, Vol.25, 3, 431-457.
- Farch, C., Kasper, G. (1986). The role of comprehension in second language learning. *Applied Linguistics* 7, 257-274.
- Fisser, P., Strijer, A. (2014). Using ICT for personalized and adaptive learning, the case of Linked Data. *Proceedings of Society for Information Technology & Teacher Education International Conference 2014*, pp. 1243-1247.
- Goh, C.C.M. (1998). How ESL learners with different listening abilities use comprehension strategies and tactics. *Language Teaching Research* 2, 2, pp.123-147.
- Goh, C.C.M. (2000). A cognitive perspective on language learners' listening comprehension problems. *System* 28(1), 55-75.
- Goh, C.C.M. (2002). Exploring listening comprehension tactics and the interaction patterns, *System* 30, 185-206.
- Goh, C.C.M. (2008). Metacognitive Instruction for Second Language Listening Development: Theory. *Practice and Research Implications. TECL Journal Vol.39 (2)*, 188-213.
- Holden, R. (2004). Facilitating Listening Comprehension: Acquiring Successful Strategies. *Bulletin of Hokuriku University Vol.28*, 257-266.
- Hossein B. (2013). Enhancing foreign language learning through listening strategies delivered in L1: An Experiment Study. *International Journal of Instruction*, Vol.5, No.1.
- Li, H., Hasegawa, S. Improving Academic Listening Skills of Second Language Learners by Building up Strategy Object Mashups, *Proceeding of the 16th International Conference on Human-Computer Interaction (HCI)*, Greece, (12) 384-395.
- Li, Y, Wang, L. (2012). College English Listening Strategy Training Model in Computer-Assisted Language Learning Environment and the Corresponding Effect Analysis. *US-China Foreign Language*, Vol.10, No.11, 1752-1758.
- Mason, A. (1995). By dint of: student and lecture perceptions of lecture comprehension strategies in first term graduate study. *J.Flowerdew, (ed), Academic Listening: Research Perspectives*. 199-218.
- O'Mally, J., Chamot, A. (1989). Listening Comprehension Strategies in Second Language Acquisition. *Applied Linguistics*, 10(4), 418-437.
- Oxford, R., Nyikos, M. (1989). Variables Affecting Choice of Language learning Strategies by University Students. *The Modern Language Journal*. Vol.73 (3), 291-300.
- Ogata, H., Yano, Y. (2004). Knowledge awareness for a computer-assisted language learning using handhelds. *International Journal of Continuing Engineering Education and Life Long Learning*, Vol.14, 435-449.
- Richards, J. (1983). Listening comprehension: Approach, design, procedure. *TESOL Quarterly*, 17, 219-239.
- Smidt, E., Hegelheimer, V. (2004) Effects of online academic lectures on ESL listening comprehension, incidental vocabulary, and strategy use. *Computer Assisted Language Learning*, 17, 517-556.
- Vandergriff, L. (2004). Listening to learn or learning to listen. *Annual Review of Applied Linguistics Vol.24*, 3-25.
- Wang, J., Mendori, T. (2013). An Evaluation of A Customizable Ontology-driven Language Learning Support System. *21st International Conference on Computers in Education*, pp.11-19.
- Wikipedia: Blended Learning. http://en.wikipedia.org/wiki/Blended_learning.
- Yang, T., Hwang, G., Chiang, T., Yang, S. (2013). A Multi-dimensional Personalization Approach to Developing Adaptive Learning Systems. *Human-Computer Interaction and Knowledge Discovery in Complex, Unstructured, Big Data Lecture Notes in Computer Science*. Volume 7947, 2013, pp.326-333.

Cross Campus Peer Feedback on Writing using a Web 2.0 Resource: Initial Findings

Gloria Shu Mei CHWO^{a*}, Sylvia Wen Lin CHIU^b

^a Dept. of Applied English, Hungkuang University, Taichung, Taiwan

^b Graduate Institute of English, National Chunghwa University of Education, Taichung, Taiwan

Abstract: With the ever increasing use of web 2.0 resources in support of English as an International Language (EIL) teaching, the increase in learner online collaborative / social learning necessitates research to enhance our understanding of this form of activity. This study therefore investigated a specific case of EIL learners providing peer feedback on the writing of other EIL learners through a Web 2.0 resource. Anonymous asynchronous nonreciprocal feedback was collected from students in three Taiwanese universities participating in a cross campus activity commenting on peer narrative compositions posted on the *Storybird* internet site. The aims were to ascertain what kinds of feedback were provided and whether it varied depending on the apparent proficiency of the person whose writing was being responded to. The writers were of two levels of proficiency (freshman and senior). Results from qualitative and quantitative analysis show a rich variety of kinds of response. In general the focus was on the content more than the form and included a considerable amount of genuinely communicative response to the message in the story being read. There were a number of differences in both the quantity and quality of the feedback given to each group of writers, which with the less proficient group often exhibited signs of politeness strategies such as starting with a positive comment to soften later negative comments, using more positive than negative comments, and establishment of an interpersonal tone with explicit use of first and second person pronouns. The findings suggest that this type of feedback is potentially valuable to complement conventional teacher feedback, and that the cutting edge technology of Web 2.0 can be valuably integrated into the formal curriculum for EIL learning.

Keywords: writing (composition), comment (feedback), EIL, peer evaluation, online learning

1. Introduction

The benefits of Web 2.0 for education, including foreign language learning, have been widely advocated (e.g. Luo, 2013; Wang and Vasquez, 2012). Although a good deal of empirical research is actively ongoing, there remain many specific backgrounds and levels of learner and many types of language task where we still have insufficient evidence to be able to say with confidence even what actually occurs, let alone how effective it is, when learners engage in language-related activity through this medium. The current study therefore aims to add to our knowledge by investigating one such specific case - the kinds of feedback provided by university level EIL non-majors in Taiwan to stories written by peers of more than one proficiency level.

There is a continuing history of studying feedback (aka response, review, evaluation, assessment) given to students about what they write. Traditionally this includes considering not only teacher feedback but also peer feedback and self-feedback, and latterly automated computer feedback, provided either during the writing process or after a final draft has been produced. Research begins with analyzing what kinds of feedback these different sources give, on various dimensions such as corrective versus non-corrective (Ferris, 2012) and many others (e.g. Ellis, 2009).

Most of this research has been on handwritten compositions where feedback is given on the hardcopy, often in a classroom setting. However, where the composition is produced and revised electronically, there is the opportunity for more and more writing, even in the context of classroom instructed learning, to be not just written but also delivered electronically and to receive feedback through the same medium, whether from a teacher or from peers (Ware and O'Dowd, 2008) or an online writing centre (Rosalia, 2010) or from other readers. Indeed increasingly compositions are more widely published or shared in some way online via blogs (Vurdien, 2011), wikis (Woo et al., 2013; Pifarre and Fisher, 2011), *Moodle* (Diez-Bedmar and Perez-Paredes, 2012) or websites designed for this purpose, such as *iLap* (Lu and Law, 2012) or *Storybird*, which is the subject of the current study. In this way compositions are liberated from the classroom environment and available for feedback from anyone

who is licensed to access the site and chooses to read them at any time, including teachers, peers and complete strangers on the WWW, who may include native speakers of the target language (and collaborative rather than single-authored writing is also facilitated).

This sort of asynchronous computer mediated (CMC) feedback on writing has been relatively little studied and while we know of a few studies close to ours, none have precisely the same parameters. For example they involve peer feedback on email correspondence rather than compositions (Vinagre and Munoz, 2011), or on asynchronous discussion (Ware and O'Dowd, 2008), or they involve feedback from peers who are native speakers of the target language of the writers rather than other learners of it (Li, 2013), or from teachers of writing (Alvarez et al., 2011). Although these studies suggest something of the kind of feedback provided, they do not throw light on whether peers differentiate between writers of different levels. For our task and situation, the first requirement, as we perceive it, is to investigate simply what kind of feedback is given in this medium by genuine learner peers, and how far it resembles feedback found in other studies, including of non-internet published compositions, and whether peers are sensitive to different kinds of writers. From such a base one can then progress to other crucial issues such as the effectiveness of the feedback.

2. Research questions

2.1. What kinds of unprompted feedback in English do Taiwanese university students give in online response to English compositions by unknown non-English major peer learners?

2.2. Is their feedback different depending on the level of writing proficiency exhibited in the compositions?

3. Method

3.1. *The context and participants*

The study took place with cooperation of three Taiwanese universities. We gathered two sets of stories written by Taiwanese students and published in *Storybird*, each with feedback via *Storybird* from other Taiwanese students, all in English. All participants were native speakers of Chinese, of ages ranging between 18 and 25.

The story writers came from two non-English major groups which participated. Those taking the Children's Literature Appreciation and Creation course (CLAC) were seniors so reasonably proficient in English. Those taking the Oral Training course (OT) were freshmen so of lower English proficiency.

The students giving feedback on the stories were other Taiwanese students of rather varied English proficiency levels. Some were from the same university as the writers, others from other universities.

3.2. *Procedure*

25 CLAC and 31 OT students each wrote a story individually online in *Storybird* as part of course requirements. No suggestions were made as to what topics to write about, or for what audience, except that if they could not think of an imaginative topic they should write introductions about themselves. In fact the OT story writers fell back on this option quite often, and generally wrote shorter stories than CLAC students. The teacher intention in getting them to do this was to practice their general English writing skills, in narrative genre. The students knew they were going to get feedback via *Storybird* from other Taiwanese students whom they did not know.

The pool of students giving feedback had access to *Storybird* to respond to whatever stories they wanted to from OT or CLAC writers. In fact they did not all respond to all stories, and indeed some only responded to CLAC stories, some only to OT stories. These students were asked to respond in their own time out of class. Participation was not obligatory and no incentives were offered. The respondents were not prompted as to which stories to respond to nor trained in how to respond, since we were interested in their spontaneous feedback, and they were not told that some stories were from students of different English proficiency from others.

3.3. *Data Analysis*

The feedback was downloaded and stored in Word files, where it was analysed by the researcher repeatedly, using the Comment function to record the analysis. First, 656 distinct chunks were identified which appeared to constitute distinct pieces of feedback information. Next, these chunks were each multiply coded in an initial coding for key aspects of the content of the feedback. For example the chunk *You have misspelled some words* was coded LANG SP NG U, capturing that it was

Table 1: Incidence of different categories of feedback, standardized per 1000 words of feedback.

Feedback category		Group of writers responded to		
		CLAC	OT	Overall
Evaluative position with respect to (some aspect of) the story	Description (Non-evaluation)	10.0	9.5	9.75
	Positive Evaluation	27.5	32.6	30.05
	Negative Evaluation	26.3	18.3	22.3
Aspect of story targeted	Language, including:	11.9	18.3	15.1
	Grammar	4.7	5.8	5.25
	Spelling	3.1	0.7	1.9
	Vocabulary	1.6	1.0	1.3
	Fluency	0.0	2.0	1.0
	Content, including:	56.3	52.3	54.3
	Part of story only	4.1	4.8	4.45
	Plot of story	11.9	2.0	6.95
	Other aspects of the stories:			
	Genre	1.3	7.5	4.4
	Simplicity	4.1	2.4	3.25
	Shortness	5.9	3.1	4.5
	Style	2.2	1.0	1.6
	Specific item	3.4	1.7	2.55
Pictures	3.1	3.4	3.25	
Reported effect on feedback giver	Affective	4.7	2.7	3.7
	Cognitive	6.9	7.8	7.35
Non-declarative formulations used	Suggestion	17.5	12.9	15.2
	Comment	13.8	17.3	15.55
	Hope	1.3	6.5	3.9
	Thanks	1.3	2.7	2.0
	Greeting	0.0	1.7	0.85
	Question	1.6	2.0	1.8
Explicit reference to participants in communication	Feedback giver (I)	26.6	29.2	27.9
	Writer (you)	27.5	53.7	40.6
	Audience in general	2.2	4.8	3.5
Communicative response to writer's message		18.8	29.6	24.2

a negative evaluation statement targeting an aspect of the language, the spelling (though not pointing to a specific item), with explicit reference to the writer. *I hope that you have a satisfied career in the*

future was coded HOPE I U CM, capturing that it is an expression of hope with genuinely communicative force, mentioning both the reviewer and the story writer explicitly. This coding was progressively refined as the data was gone over repeatedly.

Initially it was planned to use one of the feedback classifications from the literature, but it soon became apparent that those were unsuitable as they mostly dealt only with corrective feedback, which was a small minority of the feedback in this study. Hence we adopted a more ethnographic approach and developed from the data itself a set of codes which seemed to capture the main themes expressed. The resultant classification is wide-ranging over linguistic and non-linguistic areas (see the categories in Table 1). For quantitative reporting, since the amount of feedback was different for each of the two groups of stories, frequencies are presented standardized per 1000 words of feedback.

4. Results

A number of results stand out. First, the amount of feedback providing language correction, common in many studies of feedback on writing, is relatively small. As Table 1 shows, positive attitudes are expressed more often than negative ones (which are implied by correction), and instances of feedback on core areas of language such as grammar and vocabulary are far outnumbered by those on content and other matters. Furthermore, there was a considerable amount of communicative feedback, in the sense of response to the actual message conveyed by the writer rather than to the language or coherence of storyline etc.

Second, there are some clear effects of the two groups of story writers. Stories by more proficient CLAC writers received feedback from between 0 and 41 people (average 15.3 per story), and the amount of feedback was on average 517 words per story. By contrast the less proficient OT stories attracted feedback from between 0 and 11 people (average only 3 per story), and the average length of feedback was only 95 words per story. The number of words written by each person giving a response was only slightly less for OT stories, however: 32 on average versus 34 for CLAC. Hence the key difference is in how many people chose to respond to stories from the two sources rather than how much feedback each person who did respond wrote. We speculate that, left to their own choice, in contrast with most studies in the literature where they are required to respond, the respondents in our study opened some OT stories and thought them too simple or full of errors to be worth commenting on so closed them without responding. CLAC stories on the other hand attracted their interest more.

There are also clear differences in the type of feedback, based on our analysis of its content (Table 1). One notable difference is in the evaluation. There is slightly more evaluation overall of the CLAC stories, but what is more marked is the difference in polarity. While the amount of positive and negative evaluation of CLAC stories was more or less the same, OT stories received considerably more positive than negative evaluation. This is clearly not because the OT stories were actually better, but presumably reflects a wish to encourage what were detectably weaker students. What is not reflected by the table is that also in general in the feedback given by each person a positive point was mentioned first, before negative ones, with the same softening effect.

Another key area of difference is in the areas focused on. One might have expected considerably more attention to the language of the less proficient OT stories, and indeed language feedback is 50% greater than that given to the CLAC stories. However, it remains little compared with feedback on content and is largely given at a general level, with few specific items identified, and only slightly greater attention given to grammar. The greater feedback on genre could be due to the fact that many OT stories turned out to be self-presentations rather than stories as such. Furthermore, OT stories receive considerably more communicative response than CLAC ones, suggesting a wish by the feedback givers to demonstrate to OT writers that it was possible to engage with the message conveyed by their texts despite the deficiencies in the language used to convey it. Finally, OT response is characterized by far more explicit reference to the OT writer by the respondent than occurred for CLAC, so conveys to the writers reading the feedback a much greater feeling of personal attention.

By contrast CLAC writers attracted more negative evaluation than OT ones, though this is directed more towards aspects of the content, such as the story plot, than to the language. CLAC writers were also to some extent criticized for writing too briefly or simply, perhaps because the feedback givers recognized that their level of writing ability allowed them potentially to write at a higher level than some of them did.

5. Discussion and Conclusion

This is a small, exploratory study, but nevertheless highly suggestive. The focus on content rather than language form bears witness to the impact of the ‘content creation’ focus of Web 2.0 in general, while the incidence of fully communicative responses is consistent with its ‘social rapport’ aspect (McLoughlin and Lee, 2007). Most studies of feedback (whether on paper compositions or online text) are, explicitly or by implication, conducted in conditions where corrective feedback is required or expected, and hence we do not see this focus. Ware and O’Dowd (2008) however did include an ‘e-partner’ condition where respondents were left free, and report a similar finding to ours that when peers are not instructed to respond on matters of language form, they very often choose not to. There seems little doubt that the nature of the medium, along with the fact that participants were not in our study directed in what feedback to give, allowed or encouraged the participants to give feedback in a much richer and more humanistic way than the traditional narrow range of largely negative evaluative and language oriented feedback. The feedback often feels closer to a social exchange or conversation (Danis, 1987) than an educational response, and far from mimicking “teachers’ feedback, which was mostly teacher-centred, <and> made students passive and dependent on teachers.” (Lee, 2008: 144). The following example of a complete piece of feedback to a CLAC story illustrates how the respondents were often able to combine feedback on content and language with elements of communicative response to the message: “You use simple words successfully to show us the great family’s love!! It is very close to our daily lives because sometimes when there is a new member in our family, some parents would feel so happy that ignore their children without the intention. But actually parents love their all children very much from their deep heart! But maybe you can mention the new member’s relationship with the boy later in the story. I think that it would become more complete!!”

The differences between responses to writers of different proficiency levels also show students’ ability to vary response according to the writer, where they choose to respond, which is a characteristic also of expert teacher response (Vandercook, 2012). Although language issues are predictably more targeted with less than with more proficient writers, there seems to be an attempt to encourage weaker writers by also emphasising positive aspects, targeting content more than language, and engaging in more communicative response with a strong interpersonal tone than with more proficient writers. In effect this is a form of what has been termed mitigation in the traditional feedback literature (Treglia, 2009).

In conclusion, there is much more work to do in this area. Interviews would be valuable to confirm some of the interpretations we have offered. The impact on the story writers needs to be investigated, such as how satisfied they were with the feedback, what they implemented as a result, and of course whether they benefited, e.g. in being encouraged to write more or in improvement of their writing products. Some traditional studies have suggested that in fact it is specific feedback on language points that is most expected and effective (e.g. Sweeney, 1999), hence it remains to be seen whether the rather different focus of unprompted Web 2.0 mediated feedback in fact also has learning benefit. The impact on the respondents can also be investigated. Their English was also far from perfect, but does it in any way improve through this sort of activity? Topics like this have been researched in the traditional feedback literature, but are as yet largely untouched in the online Web 2.0 medium for non-native speakers. The challenge for Web 2.0 at university level remains whether such EIL peer interaction provides a “means to link informal and recreational writing with formal and academic writing.” (Godwin-Jones, 2008:7).

Acknowledgements

We would like to thank Prof. Meei-Ling Liaw for her leadership of this project, Assist. Prof. Agatha Fan and Associate Prof. Min-Hsun Chiang for their collaboration. We are indebted to their contribution to the findings of this study.

References

Alvarez, I., Espasa, A., & Guasch, T. (2011). The value of feedback in improving collaborative writing assignments in an online learning environment. *Studies in Higher Education*, 37(4), 387-400.

- Danis, M. (1987). The voice in the margins: Paper-marking as conversation. *Freshman English News*, 15, 18-20.
- Diez-Bedmar, M. & Perez-Paredes, P. (2012). The types and effects of peer native speakers' feedback on CMC. *Language Learning & Technology*, 16, 62-90.
- Ellis, R. (2009). A typology of written corrective feedback types. *ELT Journal*, 63, 97-107.
- Ferris, D. (2012). Written corrective feedback in second language acquisition and writing studies. *Language Teaching*, 45, 446-459.
- Godwin-Jones, R. (2008). Web-writing 2.0: Enabling, documenting, and assessing writing online. *Language Learning & Technology*, 12, 7-12.
- Lee, I. (2008). Student reactions to teacher feedback in two Hong Kong secondary classrooms. *Journal of Second Language Writing*, 17, 144-164.
- Li, J. (2013). Language development and scaffolding in a Sino-American telecollaborative project. *Language Learning & Technology*, 17(2), 193-219.
- Lu, J., & Law, N. (2012). Online peer assessment: Effects of cognitive and affective feedback. *Instructional Science: An International Journal of the Learning Sciences*, 40, 257-275.
- Luo, T. (2013). Web 2.0 for language learning: Benefits and challenges for educators. *International Journal of Computer-Assisted Language Learning and Teaching*, 3(3), 1-17.
- McLoughlin, C., & Lee, M. (2007). Listen and learn: A systematic review of the evidence that podcasting supports learning in higher education. In C. Montgomerie & J. Seale (Eds.), *Proceedings of World Conference on Educational Multimedia, Hypermedia and Telecommunications 2007* (pp. 1669-1677). Chesapeake, VA: AACE.
- Pifarre, M., & Fisher, R. (2011). Breaking up the writing process: How wikis can support understanding the composition and revision strategies of young writers. *Language and Education*, 25, 451-466.
- Rosalia, C. (2010). *EFL students as peer advisors in an online writing center*. Ed.D. Dissertation, New York University.
- Sweeney, M. (1999). Relating revision skills to teacher commentary. *Teaching English in the Two-year College*, 27, 213-218.
- Treglia, M. (2009). Teacher-written commentary in college writing composition: How does it impact student revisions? *Composition Studies*, 37, 67-86.
- Vandercook, S. (2012). *Exploring the relationship between English composition teachers' beliefs about written feedback and their written feedback practices*. PhD dissertation, University of New Orleans.
- Vinagre, M., & Munoz, B. (2011). Computer-mediated corrective feedback and language accuracy in telecollaborative exchanges. *Language Learning & Technology*, 15(1), 72-103.
- Vurdien, R. (2011). Enhancing writing skills through blogs in an EFL class. *European Association for Computer-Assisted Language Learning (EUROCALL)*, paper presented at the EUROCALL Annual Conference, Nottingham, United Kingdom, Aug 31-Sep 3.
- Wang, S., & Vasquez, C. (2012). Web 2.0 and second language learning: What does the research tell us? *CALICO Journal*, 29, 412-430.
- Ware, P., & O'Dowd, R. (2008). Peer feedback on language form in telecollaboration. *Language Learning & Technology*, 12, 43-63.
- Woo, M., Chu, S., & Li, X. (2013). Peer-feedback and revision process in a wiki mediated collaborative writing. *Educational Technology Research and Development*, 61, 279-309.

Development of Multimodal Tool to Support Pronunciation Training in Second Language Classroom – Case of Japanese^{*}

Nushrat Jahan KHAN^a & Hideo JOHO^b

^aGraduate Student, University of Illinois at Urbana-Champaign, USA

^bAssociate Professor, University of Tsukuba, Japan
njkhan2@illinois.edu

Abstract: Rapid technological advancement in computer and mobile technologies has resulted in inclusion of different multimodal tools for teaching and learning language. Most of these software and tools are designed to assist learning process of adults and mostly used for remote learning. But there are fewer studies that take into account the needs of such technology in children's language classroom and suggest tool development according to children's intellectual level. While most of the studies focus on English language learners, not many studies focus on acquisition of Japanese as a second language at elementary level. In this study we focused on finding out technological needs of the teachers to understand what kind of tool can actually fit language classroom and meet children's need and intellectual level. From the analysis of user studies, we derived the key functions of the interface that are – lesson customization, personalization and feedback for integrating the tool in classroom. Based on those key components, a multimodal tool containing image and audio functions was developed on iOS platform. The interface was then evaluated by a group of users that received positive feedback. The full result of the evaluation will be reported later.

Keywords: second language acquisition, pronunciation training, multimodal application

1. Introduction

1.1 Research Topic

Emerging technological advancements in the field of information science and technology in the last couple of decades have given rise to remarkable change in the way people gather knowledge and information. Therefore, representation of learning contents have changed from simple text-based reading and writing to mixture of textual, audio and visual modes, which is often referred to as multimodality (Miller, 2007).

With the development of Computer Assisted Language Learning (CALL), researches on the implication of computer for teaching and learning foreign language have increased to a prominent level (Levy, 1997). But Fox (1993) argues that, "there is no generally accepted theory of Second Language Acquisition (SLA) to embrace with confidence". Garton (1992) further suggests that, "One must look carefully at the specific attributes of this learning environment and then consider which model of SLA most closely matches the capabilities of hardware and software." Therefore, prior to implementing CALL courseware for a particular language like Japanese, further understanding of learning context is necessary. According to Weber (1997), the number of people who spoke Japanese as second language was approximately 8 million in 1997. According to the survey of Japan Student Services Organization (JASSO), the number of foreign students studied in Japan was reported to be around 140 thousand in 2012, which includes both adult and children. Since the official language at Japanese educational institutions is Japanese, these students typically have to conduct their study in

^{*} This work was carried out when the first author was a student of the University of Tsukuba.

Japanese. They also have to deal with all kind of information in Japanese in their daily life. Moreover, according to the report of Modern Language Association, there is a significant expansion in the number of Japanese learners in U.S. colleges and universities, where an increase was 10.3% from 2006 to 2009. However, the number of studies on Japanese teaching and learning as L2 at elementary level is limited.

1.2 Literature Review

There have been many studies that have examined the effect of CALL in classroom environment. Tsou, Wang & Tzeng (2006) have reported that applying multimedia storytelling website in foreign language learning was effective in developing language proficiency, story comprehension and sentence complexity of students in English classroom. Similarly, Tsou, Wang & Li (2002) have used CALL method for students to find out how computers facilitate foreign language learners to learn abstract words. In their study, the interface helped the students to learn at their own paces and teachers had little contribution to regulate the course material. Johnson et al (2005) have implemented artificial intelligence for developing serious games for learning language.

While most studies tend to focus on the reading skill or acquisition of vocabulary and grammar, studies that focus on the speech and communication development in classroom are limited. As stated by O'Brien, M.G. (2004), classroom pronunciation training should begin early, as prosody (rhythm, stress or intonation) becomes one of the deciding factors of good communication for L2 learners. She also states, "Nonnative pronunciation- what many of us refer to as a "foreign accent"- in a second language (L2) is problematic." But as Levis (2008) mentioned pronunciation was not even classified as a topic of two prominent journals related to CALL from 2001 to 2006. A survey by Mizumachi (2006b) brings into light that there has scarcely been any work related to prosody in Japanese. The survey further suggests that, even though learners prefer Japanese training websites with multimedia features, more than 55% of the sites are text-based. The interface developed by Mizumachi (2006, p. 137) for understanding intonation of target language uses text from English and Chinese. However, dependency on learners' first language (L1) makes it difficult to implement it especially at elementary level, where children are still in the developing state of L1. Furthermore, even though young people these days are called as digital natives who are good at dealing with digital technologies (Prensky, 2010), to design useful applications for learning it is important for information professionals to properly investigate their level of expertise (Selwyn, 2009).

Therefore, further studies are needed for developing multimodal tools that do not solely depend on text but integrate different forms or content representation such as image, audio, and video. Furthermore, such tools should fit in conventional classroom context while meeting pedagogical and technological needs of both teachers and learners.

1.3 Aim of Research and Research Questions

To address the lack of multimodal tools for elementary level L2 learners of Japanese, this study aims to understand the context and needs of language teachers. Based on the findings of user research conducted with Japanese L2 teachers at local schools, we propose the functionalities of the interface that will best serve the purpose. The usability of the interface is then evaluated by the language teachers. Finally, we discuss about future directions for developers. More specifically, this study addresses following research questions:

- What are the conventional methods used in classroom for training Japanese as second language to at elementary level, and what are the challenges faced by teachers in the conventional system?
- How can multimodal tools aid those challenges?
- How should the user interface be designed so that the educators can use the tool without prior technical knowledge and suit classroom pedagogy at the same time?

1.4 Organization

The rest of this paper constitutes of the following sections. Sections 2 describes user research method and outcomes, design process of the tool based on the proposed functionalities and evaluation method.

Section 3 discusses the main findings of this study while looking at the limitations. It also discusses future directions.

2. Methodology

To propose an interface that can address classroom needs of teacher, we emphasize on understanding user needs and the context of implementation. Therefore, we adapted User Centered Design (UCD) as the method for developing interface, which is the practice of taking more human factors into account in system design (Mathis, 2011), rather than technology centered perspective.

2.1 User Centered Design (UCD)

User Centered Design is an iterative process that goes from user research to design to implementation (Mathis, 2011). We followed Mathis (2011) to generate questions for user research. Specific objectives for finding problems are 1) Find out what people are currently doing, 2) Find out what people have to do but really dislike doing, and finally, 3) Find out what they would like to be doing. Similarly, objectives for solutions are 1) Find a way of making what they are already doing easier and more efficient, 2) Find a way of making the things they dislike obsolete, or at least more fun, and finally, 3) Find a way of making what they want to be doing possible.

The user research is then analyzed and followed by design process, which involves steps like concept development, prototyping and development of the user interface. Additionally, we have followed the methods and principles of UCD from Gulliksen et al. (2003) which suggest user focus, active user involvement, evolutionary system development, simple design representations, prototyping, evaluation and holistic design. More detailed description is given in each section later.

2.2 User Research

There were three formal interviews with three Japanese language teachers from different elementary schools. All the participants were selected based on their long time experience in teaching Japanese where the average teaching year was 11. The questions of interviews were open ended, which had ensued subset of questions not mentioned in the primary questionnaire. For example,

- What type of difficulties children face while communicating in L2?
- What kind of teaching method is used to improve communication skill of kids in classroom?
- Whether the teachers have experience of using multimedia interface in classroom and or not? If yes, then what are the types of those tools?
- What type of needs cannot be fulfilled in conventional method?
- What are the difficulties felt while communicating with kids?
- What methods are used in classrooms to encourage positive interaction and hold concentration?

2.3 Deriving Key Functionalities

This section describes how we derived key functions from the outcome of user interviews.

2.3.1 Outcome of user research- phase 1 (User needs)

From the information gathered from user interviews, we extracted the common activity that needs to be supported and how can those be aided with technologies. The activities needed support and the conventional teaching methods are summarized in Table 1. We have then extracted the technical and pedagogical needs to support, as shown in Table 2.

2.3.2 Key functions of interface

Based on the findings of user research, we determined the key functions of the interface as follows:

Table 1 User needs and SL classroom pedagogy

	Activities to support	Conventional methods used in classroom (SLA pedagogy)	Use of technology in classroom
Teacher A	Guide pronunciation of individual student	Natural language acquisition process by showing physical expression, read aloud, collaborative learning in pairs; i.e. native and non-native	Not used for teaching. Laptops are used for subjects such as Math and English.
Teacher B	Keep record of student's speech	Read aloud, present in the target language on given subject, conversation practice between students of similar level	Not used for teaching. There is computer room in school but not used for language class
Teacher C	Guide prosodic skills to students so that the student can listen to different speaker's pronunciation and intonations	Physically expressed to teach the meaning and context of using words, draw picture that describes a story and ask the student to explain	Not used for teaching

Table 2 Challenges and probable solutions

Challenges	Probable solution
The learning material should be applicable for different range of learners	Give teachers the flexibility to create learning material instead of offering fixed curriculum.
Individual guidance is necessary	Being able to follow personal response would make it possible to understand the difficulty of each student's pronunciation.
Fit into the classroom pedagogy	Give flexibility to teacher to create own curriculum.
Decode the words pronounced by a user, understand the intonation	Be able to listen to native speaker's response and compare with own.
Giving feedback to motivate communication is necessary	Provide grading option on student's response and comment on the difficulty of particular student.

Customization: The freedom to customize practice lessons is given preference in the initial development of application since it was a common user need. As it is suggested from user research that, "the difference in cognitive ability of different group of children makes it difficult to generalize the set of practice problems." So, unless a tool developer has comprehensive knowledge about that language and has teaching experience, the appropriateness of lessons for a particular target group cannot be verified. Also, in the language classroom, students can have different L1 (first) language, which can cause difficulty with particular pronunciation. To emphasize on the pronunciation difficulties particular to a L1 group is necessary to improve overall comprehensibility of the second language learner (Levis, 2007). Customization of lessons also allows the teacher to understand and guide with difficulty of individual student.

Personalization: Another important need expressed by participants was an ability to personalize the tool. Since it is difficult to follow the progress or difficulty of individual student's pronunciation in classroom unless the guidance in classroom is 1:1, keeping record of each student's pronunciation is one of the basic needs of the teachers. As one of the teacher said, "Personalized

training also makes it possible to study after school hours which can be reviewed by teacher later”. Therefore this function makes the interface more potent for use in different settings.

Feedback: Giving feedback on pronunciation training is another challenging issue, but is considered as an important one by the users. In teacher’s words, “even simple feedback can give the feeling of accomplishment to the children and keep them motivated.” Therefore we have focused on how to give feedback to the children so that it is easily understood and also be helpful.

2.4 Prototyping

Following the UCD method, we performed interface prototyping based on the analysis of user research. At first we focused on the technical functions necessary to meet the user needs. Then, gradually we developed the idea of user interface by prioritizing most important functions and sketching the screen transitions. Initially the prototyping was done on paper by pencil sketch. Later by using computer created a clearer graphical representation. The final implementation was done on iOS platform as described in the interface development section (Section 2.5). The second phase of interview was to evaluate the prototype. The interview time was 1 hour where the detailed functions of the interface were described using paper prototype and the user was asked whether there is any particularly difficult part and to advice on total design.

2.5 Interface development

In this study we have deployed the interface for iPad. A development middleware called PhoneGap (<http://phonegap.com/>) was used for coding and building the application. PhoneGap is a web-based mobile development framework, based on the open-source Cordova project (<http://cordova.apache.org/>) that allows using standard web technologies such as HTML5, CSS3 and JavaScript for cross-platform development. For creation of database of the system SQLite was implemented. Also jQuery was used for providing animation between screen transitions and other functions of the interface. The interface is mainly divided into two sections: Teacher’s section and Students’ section. From the home page teachers and students can access their designated pages. We implemented our key functionalities as follows.

Customization of lesson: The teacher is given the authority to create lessons for students, edit and delete. Lesson can consist of text, image and audio (Figure 1a). Personalization: Students can create own account by entering name and image (optional). Each student can practice the lessons, save their response, come back to check feedback and also listen to fellow students response (Figure 1b). Feedback: After the students respond to practice questions, teacher can review them and give feedback with number and comment (Figure 1c). Only teacher has the authority to provide and change feedback.



Figure 1. (From left to right) a. Lesson creation page, b. Students’ response page, c. Feedback page

2.6 Evaluation of Interface

The interface was later evaluated with a local teacher and their students in a real life classroom environment. We had some promising feedback about our interface. However, the full result will be reported elsewhere due to a lack of space.

3. Concluding discussions

From this study we can understand that, even though there are many technological advancements taking place, the cases where tools are used at elementary level classroom and they reflect the user needs can be limited. However, teachers do feel the need of digital tools to guide pronunciation, as it is difficult to follow each student's progress in conventional classroom. Also it is important that the tools match the intellectual level of children, as it can be different for different age groups of students. So customization option gives the flexibility to create lessons for different group of users and by personalizing the tool, it makes it possible to follow each student's progress. Also simple user interface and easy navigation is a must so that users can use without much prior technical knowledge.

The outcome of this study is limited due to the small number of user interviews. Since more interviews with Japanese language teachers would help to achieve further comprehensive insight of their needs, the outcomes here might not represent global needs of teachers. This multimodal interface is currently in its preliminary version, which supports simple image and audio functions. It can be augmented in many ways in future. The future upgrades can include the functions like Text To Speech (TTS) and Pitch Tracings. While the availability of TTS application for Japanese is quite low in mobile app developing environment, integration of this system would result in decreasing instructor's labor of creating lessons by automated conversion of speech from text. Also collaborative learning should be considered in future versions since it is very common in classroom pedagogy and can be beneficial to develop better communication among second language learners.

References

- Fox, J. EC (1993). Research in language learning and IT – some experienced with LINGUA. *Journal of Computer Assisted Learning*, 9(2), 100-106.
- Garton, J (1992). Learning how to manage text with interactive multimedia. *On-Call*, 7(1), 17-22.
- Gulliksen, Jan; Göransson, Bengt; Boivie, Inger; Blomkvist, Stefan; Persson, Jenny; Cajander, Asa (2003). Key principles for user-centered systems design. *Behaviour & Information Technology*, 22(6), 397-409.
- Johnson, W. Lewis; Vilhjalmsson, Hannes; Marsella, Stacy (2005). Serious Games for Language Learning: How Much Game, How Much AI? *Artificial Intelligence in Education*, 306-313.
- Levy, M (1997). *Computer-assisted language learning: context and conceptualization*. Clarendon, Oxford, 298.
- Levis, John (2007). Computer technology in teaching and researching pronunciation. *Annual Review of Applied Linguistics*. 27, 184-202.
- Levis, John M (2005). Changing contexts and shifting paradigms in pronunciation teaching. *TESOL Quarterly*. 39(3), 369-378.
- Lukas, Mathis (2011). *Designed for Use: Create Usable Interfaces for Applications and the Web*. Pragmatic Bookshelf.
- Miller, Suzanne M (2007). English Teacher Learning for New Times: Digital Video Composing as Multimodal Literacy Practice. *English Education*, 40(1), 61-83.
- Mizumachi, Isao (2006). *Computer Assisted Japanese Learning and Teaching*. Keisui Company.
- Mizumachi, Isao (2006b). Multimedia Learning Materials for e-Learning in Japanese and Assistance for Teachers. *Hiroshima University Japanese Education Research*, 16, 41-48.
- “New MLA survey report finds that the study of languages other than English is growing and diversifying at US colleges and universities”. Modern Language Association.
http://www.mla.org/pdf/2009_enrollment_survey_pr.pdf, (accessed 2010-12-08).
- O'Brien, Mary Grantham (2004). Pronunciation Matters. *Die Unterrichtspraxis/ Teaching German*, 37(1), 1-9.
- Prensky, Marc; forward by Heppel, Stephen (2010). *Teaching digital natives: partnering for real learning*. Corwin A SAGE Company.
- Selwyn, Neil (2009). The digital native—myth and reality. *Aslib Proceedings*, 61(4), Emerald Group Publishing Limited.
- Tsou, Wenli; Wang, Weichung; Li, Hung-yi (2002). How computers facilitate English foreign language learners acquire English abstract words. *Computers & Education*. 39(4), 415-428.
- Tsou, Wenli; Wang, Weichung; Tzeng, Yenjun (2006). Applying a multimedia storytelling website in foreign language learning. *Computers & Education*, 47, 17-28.
- Weber, George. *Language Monthly*, 3: 12-18, 1997, ISSN 1369-9733.

Enhancing English Pronunciation with *Windows Speech Recognition* Training: A Preliminary Study

Hui-Hsien FENG^a & Ying-Hsueh CHENG^{b*}

^aDepartment of English, Iowa State University, USA

^bTeaching and Learning Center, National Pingtung University of Science and Technology, Taiwan
*sherrycheng85@gmail.com

Abstract: Teacher educators have developed great interest in applying automatic speech recognition software to improve English learners' pronunciation. However, these studies are few compared with those emphasizing on other skills such as reading and writing. This case study thus aims to fill this gap by adopting the *Windows Speech Recognition* (WSR) system to help English learners improve pronunciation skills and promote learner autonomy. Drawing on the Interaction Hypothesis in Second Language Acquisition, this study sought to answer two questions: (1) with the use of WSR in pronunciation training, what is learner performance of pronouncing /n/ and /l/ sounds? and (2) what are learner attitudes toward this training? The training lasted for three weeks, with one hour each time and twice a week. Data sets included a pre-test (screening test) and a post-test based on screen- and audio-recordings of training sessions, a questionnaire, and a semi-structured interview with students. Field notes were also recorded when the entire training process was observed. Findings revealed that learner performance shown in the screening- and posttest is not significant. However, it indicates that with appropriate training, it is possible for learners to understand the feedback provided by WSR and apply the knowledge to judge their own practices. In addition, since learners held positive attitudes towards the use of this software, it is suggested that teachers or tutors can integrate the software with their curriculum for improving English students' pronunciation skills of segmental features, their learner autonomy and learning strategy.

Keywords: Pronunciation training, computer-assisted pronunciation teaching, ESL, windows speech recognition, case study

1. Introduction

With the rapid development of technology, English-as-a-second-language (ESL) teachers have developed vested interest in applying technology in their classrooms. There is no exception in pronunciation classrooms. Computer-assisted pronunciation teaching (CAPT) provides teacher educators opportunities for making pronunciation teaching and learning more approachable. Thus, automatic speech recognition (ASR) software has been widely used because it is not restricted by time and place and thus is able to offer learners practices whenever and wherever necessary. More importantly, it can serve as a private tutor to correct learners' pronunciation. This study thus aims to adopt the *Windows Speech Recognition* (WSR) system to enhance English learners' pronunciation skills and promote learner autonomy.

2. Related Literature

2.1 Use of ASR in Computer-Assisted Pronunciation Teaching

Studies on the use of ASR in pronunciation teaching are relatively few. Two concerns have been raised by previous researchers regarding the use of ASR in computer-assisted pronunciation teaching environments. The first concern is related to the fact that ASR fails to recognize nonnative speakers'

utterance as effectively as native speakers' (Derwing, Munro, & Carbonaro, 2000). Since the database of the ASR software only collects native speakers' speech samples, it is possible that nonnative speakers' utterance cannot be identified by the software. Evaluating the accuracy of *Dragon NaturallySpeaking*® (3rd edition, 1997), Coniam (1999) examined how ten Cantonese speakers read a one-thousand-word article aloud into the computer and compared the accuracy rates produced by these speakers and those by native English speakers. Coniam calculated the accuracy rates of the identified words and clauses printed out by the computer and found that the software had a lower accuracy level in recognizing Cantonese speakers' speech than those produced by native speakers.

The other issue concerning the use of ASR in pronunciation teaching is whether the ASR software can provide constructive feedback. This function is considered important because learners need to know which parts of their pronunciation is correct and which is not. Although the ASR software could provide instant feedback (Levis, 2007), it fails to offer constructive and accurate feedback for learners to improve their pronunciation. Researchers have addressed different concerns toward types of feedback display. For example, Neri, Cucchiarini, Strik, and Boves (2002) indicate that it is questionable to provide visual feedback displays such as spectrograms and waveforms. The idea of offering spectrograms and waveforms is to provide two comparable displays, one from the native speaker and the other from the user's utterance. Though showing comparable displays might help nonnative users "imitate" the native speaker, it is a misconception since every native speaker produces spectrograms and waveforms differently. Moreover, visual feedback like these cannot teach users how to pronounce correctly in terms of the location of tongue or shape of lips. This indicates that visual plays are not good enough for providing constructive feedback for learners to improve their pronunciation.

In spite of the aforementioned issues, several pronunciation teachers consider it is beneficial to use ASR (e.g., Franco, Bratt, Rossier, Gadde, Shriberg, Abrash, & Precoda, 2010; Levis, 2007). With the increasing varieties of technology, teachers nowadays can use more accessible and effective systems such as *Windows Speech Recognition*, *Google Voice*, and *Siri* on iPhone 4S. Although these tools were not specifically designed to help pronunciation training, it is possible to develop pronunciation training based on them. In this study, we adopted *Windows Speech Recognition* to train adult English learners because of its accessibility.

2.2 Interaction Hypothesis

Technology has been widely used for language teaching and learning and such application is related to the Interaction Hypothesis theory. Interaction Hypothesis (Long, 1996), a theory of second language acquisition, refers to the idea that development of language proficiency is promoted by face-to-face interaction and communication. It is believed that conditions for acquisition are especially good when interacting in the second language; specifically, conditions are good when a breakdown in communication occurs and learners must negotiate for meaning. For example, when one of the participants in a conversation will say something that the other does not understand; the participants will then use various communicative strategies to help the interaction progress. Strategies used for negotiating meaning may include slowing down speech, speaking more deliberately, requesting for clarification, or paraphrasing (Brown, 2000).

The Interaction Hypothesis theory includes four components: input, interaction, feedback, and output. In the following, we will introduce the role ASR plays with these components.

Regarding Input, ASR software is usually a part of a CAPT package, which provides model inputs for learners to imitate. If not, language teachers and learners could search input from public media or trustworthy websites, e.g. *Dave's ESL Cafe*, *Randall's ESL Cyber Listening Lab*, *Voice of America*, and *Ted Talk*.

Moreover, according to Chapelle (2003), interaction can also happen between the user and the computer in a language learning environment. Thus, ASR software could play the role of an interlocutor and provide interactions with language learners.

One of the crucial parts of the Interaction Hypothesis is the provision of feedback. It is important because it can provide clues for learners to continue to interact with the interlocutor in order for language acquisition to occur. However, if feedback is missing after the interaction happens, acquisition might not take place. The same situation is likely to happen when the learner does not notice the feedback. Thus, feedback is considered crucial for it can create or reduce opportunities for interactions.

Last, output here refers to modified output. It indicates learners' attempt to modify problematic utterance after they receive interactional feedback. ASR software provides this benefit because after learners receive feedback, they can try as many times as possible to practice until the feedback is given.

In sum, modifying speech arising from interactions like communication breakdown helps make input more comprehensible, provide feedback to the learner, and push learners to modify their speech for better output (Long, 1996). ASR software provides input, interaction, feedback, and output for language acquisition to occur.

3. Purpose of the Study

The current study uses *Windows Speech Recognition* (WSR) to train learners' pronunciation production of two sounds: /n/ vs. /l/.

Two research questions guide this study:

1. With the pronunciation training of WSR, what is learners' performance of pronouncing /n/ and /l/ sounds?
2. What are their attitudes toward this training?

4. Methods

4.1 Participants

Participants were recruited from an ESL writing class at a Mid-western U.S. university. To identify potential participants, a pronunciation screening test was carried out to check if they have difficulties pronouncing these particular sounds: /n/ and /l/. According to Swan and Smith (2001), these sounds are commonly mispronounced by Chinese speakers. Therefore, we chose these sounds for the pronunciation training. Seven ESL students were invited to participate in the study, but only five of them completed the entire procedure. These five students (2 males, 3 females) speak Chinese as their first language and they were enrolled in diverse undergraduate programs. They were considered appropriate for the study because they were newly enrolled in the university (in their first or third semester), and they reported some pronunciation problems in their conversations with others.

4.2 Data Sets and Procedure

This study employed a case study approach (Duff, 2008) to investigate how five students participated in pronunciation training sessions. Data sets included the following:

- Pre-test (screening-test)
- Audio- and screen- recordings of six training sessions
- Posttest
- Questionnaire
- Individual interview
- Field notes based on observation of training sessions

Procedure of the study is summarized in Table 1:

Table 1: Procedure.

<i>Procedure</i>	<i>Content</i>
Screening test/Pre-test	Pronounced /n/ and /l/ sounds in minimal pairs and a paragraph.
Training Sessions 1 & 2 (Week 1)	Practiced the build-in tutorials to be familiar with WSR.
Training Sessions 3 & 4 (Week 2)	Practiced /n/ and /l/ sounds with the researcher to provide instruction of specific sounds when WSR could not identify what learners had said for more than five times, or when they raised questions.
Training Sessions 5 & 6 (Week 3)	Practiced /n/ and /l/ sounds; students needed to apply what they learned from the second week.
Posttest (two parts)	Part one included minimal pairs focusing on /n/ and /l/ sounds.
	Part two included two paragraphs; the first was the same as the one used in the screening test, and the second one was new, which also included /n/ and /l/sounds.
Questionnaire	18 five-point Likert-scale items and 3 open-ended questions.
Interview with students	Semi-structured interviews (each lasted 15-20 minutes) for understanding students' perceptions of pronunciation problems, use of WSR, evaluation on the training, and their potential use in the future.

4.3 Data Analysis

Each learner's recording was rated by the researcher according to the focal sounds mentioned above. Paired t-test was conducted to investigate whether any difference exists between the pretest (screening-test) and the posttest. Likert-scale-item responses from the questionnaire were examined through descriptive statistics, whereas responses from the open-ended questions were coded. In addition, interviews with students were transcribed and coded by *in vivo coding* and *themeing the data* (Saldaña, 2009, p. 74 & 139). Questionnaires and interviews were both used to triangulate the data.

5. Results and Discussion

5.1 Learner Performance

The screening and posttest contains two parts: minimal pairs and paragraphs specifically designed to elicit discrimination of /n/ and /l/ sounds.

Table 2: The accuracy rates (%) of /n/ and /l/ in minimal pairs and paragraphs.

Student	Minimal pair: /n/ vs. /l/		Paragraph: /n/ vs. /l/	
	Screening-test	Posttest	Screening-test	Posttest
1	86	93	55	79
2	93	100	91	100
3	93	100	100	100
4	93	100	100	93
5	79	93	64	100
Average	89	97	82	94
SD	6	4	21	9

Table 2 provides the accuracy rates of /n/ vs. /l/ in minimal pairs and paragraph level. The average of /n/ vs. /l/ in minimal pairs and paragraph level in screening-test is 89% (SD = 6%) and 82%

(SD = 21%); and that in posttest is 97% (SD = 4%) and 94% (SD = 9%). Although the difference is not significant, the increasing trend may suggest that by using WSR in pronunciation training with some training to interpret the output, it is possible for students to improve their pronunciation, even by practicing alone.

5.2 Learner Attitudes

Students' attitude is a prominent factor in mastering a second language (Lightbown & Spada, 2006). Multiple sources (questionnaires, field notes, student interviews, and learners' screen- and audio-recordings) revealed that learners held positive attitudes towards the pronunciation training with the use of WSR and believed that the training was effective.

During their practice, learners tended to repeat each word several times. When asking about the reason, they responded that they wanted to see the WSR output, namely what word would show up based on their speech. However, they reported that they were annoyed when WSR showed the wrong words around five times. If this happened, they would ask the researcher why it was like this and how to pronounce the word correctly.

Moreover, the participants revealed that they were willing to practice as many times as possible, around eight to ten times on average. They were able to make slight changes and found out in what way the WSR could show the correct word on the screen. This implies that the use of WSR could promote learner autonomy and help learners acquire learning strategies, such as self-correction and self-monitoring.

The effectiveness of the training went beyond our expectations. In addition to the two sounds designed for this study, Participant 3 reported that he learned how to say /th/ sound (as in three) and Participant 2 understood that "four" does not have the same pronunciation as "full." Participants 2 and 5 reported that they learned to distinguish the sounds of these words: "napkin" rather than "lapkin"; "thank you" rather than "sank you." Participant 4 even invited her friends to try WSR when they were in a party. All in all, WSR provided opportunities for the ESL students to practice, modify, and produce correct output.

6. Conclusion and Implication

The use of WSR seemed effective in pronunciation training because it could help learners improve pronunciation skills and promote learner autonomy and develop learners' self-correction and self-monitoring strategies. Although WSR could not accurately capture nonnative speakers' sounds, this motivates learners to practice again and again. With adequate training, learners are able to monitor their utterance and self-correct their speech. The use of WSR helped develop learner autonomy, enhance learning strategy, and improve pronunciation skills of segmental features.

Since this study adopted a case study approach, it only included five participations. For future research adopting quantitative methods, a larger sample size could be considered. This study has some limitations. It was completed within a short time period (three weeks). Therefore, it is suggested that a longer period time for training and a larger sample size may have different impact on the results. Second, since this study only examined the effects of training on learners' pronunciation of two sounds, future studies can incorporate other sounds that may be challenging to English learners, such as /th/ or vowels such as "fat" vs. "fate." Third, this study was conducted in the United States, future research could be undertaken in other countries where students use English as their foreign language (EFL). How these learners use WSR might be different from ESL learners in English-speaking countries. Their perceptions of use and difficulties can provide researchers better understanding. Finally, since this study did not include any native English-speaking instructor, to what extent the combination of a native English-speaking instructor and the WSR can provide opportunities for learners can be examined.

Acknowledgements

We would like to thank the five participants for making this research possible. Without their help, we would not have been able to begin this research.

References

- Brown, H. D. (2000). *Principles of language learning and teaching*. White Plains, NY: Longman.
- Chapelle, C. (2003). *English language learning and technology: Lectures on applied linguistics in the age of information and communication technology*. Amsterdam: John Benjamins.
- Coniam, D. (1999). Second language proficiency and word frequency in English. *Asian Journal of English Language Teaching*, 9, 59-74.
- Derwing, T. M., Munro, M. J., & Carbonaro, M. (2000). Does popular speech recognition software work with ESL speech?. *TESOL Quarterly*, 34, 3, 592-603.
- Duff, P. (2008). *Case study research in applied linguistics*. NY: Taylor & Francis.
- Franco, H., Bratt, H., Rossier, R., Grdde, V. R., Shriberg, E., Abrash, V., & Precoda, K. (2010). EduSpeak® : A speech recognition and pronunciation scoring toolkit for computer-aided language learning applications. *Language Testing*, 27(3), 401-418.
- Levis, J. (2007). Computer technology in teaching and researching pronunciation. *Annual Review of Applied Linguistics*, 27, 184-202.
- Lightbown, P., & Spada, N. M. (2006). *How languages are learned*. Oxford: Oxford University Press.
- Long, M. (1996): the role of the linguistic environment in second language acquisition. In W. Ritchie and T. Bhatia (eds), *Handbook of second language acquisition*. San Diego: Academic Press, 413-68.
- Neri, A., Cucchiaroni, C., Strik, H., & Boves, L. (2002). The pedagogy-technology interface in computer assisted pronunciation training. *Computer Assisted Language Learning*, 15(5), 441-467.
- Saldaña, J. (2009). *The coding manual for qualitative researchers*. London: Sage.
- Swan, M., & Smith, B. (2001). *Learner English: A teacher's guide to interference and other problems*. Cambridge: Cambridge University Press.

Exploring the Value of Multimedia Messaging Service for Learning English Reading: Using LINE as an Example

Pei-Hsun Emma LIU^{a*}, Ruey-S SHIEH^b, Wen-Chi Vivian WU^c

^a*Department of Applied English, Kainan University, Taiwan*

^b*Department of Information Management, Kainan University, Taiwan*

^c*Department of English Language, Literature and Linguistics, Providence University, Taiwan*

*liu.phe@gmail.com

Abstract: The development of mobile technology is rapidly changing the environment and the way of learning in school. In addition to facilitating communication, mobile devices (e.g., smart phones and tablets) have made ubiquitous E-learning more accessible and mobile learning more popular. Multimedia messaging service (MMS), such as WhatsApp and LINE, can deliver richer information, including images, audio and video files, to enhance the interest of English learners. However, whether MMS can help students learn English is of interest. The purpose of this study is to investigate the value of MMS, LINE in particular, in helping EFL students learn English, based on the concept of Dual Code Theory (Paivio, 1986). The participants are 40 college students enrolled in Freshman English Reading course. Data collection consists of pre- and post-test, MMS messages, questionnaire, student writing, and interviews. It is noted that this study is currently ongoing. Based on the comparison of students' pre- and post test, the preliminary findings indicate that the LINE-based learning activities helped students familiarize with English vocabulary and improve English reading comprehension. In addition, students who were more engaged in the LINE-based activities tended to have better improvement than those who were less active. While most students made improvement and had positive perceptions of the designed activities, some did not seem to benefit from the instructional design. More detailed description will be addressed upon the completion of the study.

Keywords: Information technology, mobile learning, English reading and writing, MMS, LINE

1. Introduction

With the rapid development of information technology, students are used to learn different dimensions of knowledge through various devices such as computers, notebooks, tablets, and smart phones. A considerable amount of literature has been published on the use of information technology in assisting teaching and learning (i.e., computer-assisted language learning (CALL) and electronic-learning (E-learning)) (e.g., Greenfield, 2003). These studies indicate that the use of information technology is beneficial when integrated in traditional learning environments.

The rising speed of mobile technology is increasing and has made ubiquitous E-learning more accessible and mobile learning more popular. Mobile technology is gaining much attention because of its characteristics such as mobility, reachability, personalization, spontaneity, and ubiquity, and its promises for education (Saran & Seferoglu, 2010). Mobile devices allow a richer learning environment for language learners (Yousefzadeh, 2012). Several attempts have been made to understand the benefits of mobile learning (M-learning) and mobile-assisted language learning (MALL) (Chen & Hsieh, 2008; Kiernan & Aizawa, 2004). These studies demonstrate the potential of mobile devices and applications in enhancing language learning.

Recently, many smart phone-based applications have been developed such as short messaging service (SMS) and multimedia messaging service (MMS). The use of SMS and MMS with mobile devices in facilitating English learning is gaining much attention. For example, Saran and Seferoglu (2010) have explored how to support foreign language vocabulary learning through multimedia messages via mobile phones. Yousefzadeh (2012) found that learning vocabulary via MMS resulted in

better learning than learning vocabulary via SMS. However, most SMS- or MMS-based studies have focused mainly on the learning of English vocabulary and very few studies have explored the learning of English through instant and interactive conversation. As mobile learning is gaining much popularity, the viability of MMS in learning English is worthy of investigation.

Therefore, the purpose of the study is to investigate how MMS, LINE in particular, supports English learning. The study aims to examine how LINE assists students' learning of English reading. The findings of the study play a significant role in defining the role MMS (i.e., LINE) plays in supporting language learning.

2. Literature Review

2.1 Multimedia Learning

As information technology becomes available, more and more teachers incorporate multimedia materials in teaching practices for the value of entertainment and comprehension (Gilakjani, 2012). Multimedia refers to "any computer-mediated software or interactive application that integrates text, color, graphical images, animation, audio sound, and full motion video in a single application" (Gilakjani, 2012, p. 57). Multimedia materials help students comprehend complex issues and improve learning. Gilakjani (2012) argued that the use of two different modalities (i.e., visual and auditory) to present information contributed to such improvement. According to Paivio's Dual-Code Theory (1986), learning improves when the information is received through two channels (i.e., visual and verbal) to construct meaning. Some studies have proved such theory valid (Plass & Jones, 2005; Chen, Hsieh & Kinshuk, 2008). Plass and Jones (2005) argued that multimedia could enhance input by making it more comprehensible. Similarly, Chen, Hsieh, and Kinshuk (2008) examined how SMS and MMS facilitate the learning of English vocabulary and found that using more than one modality is more effective than the use of a single modality. The different modalities of information presented in multimedia materials allow the language learners to increase comprehension of the materials and facilitate learning.

2.2 Mobile Messages and Language Learning

An increasing number of young users in Taiwan are communicating with each other through mobile messaging applications, short messaging service (SMS) or multimedia messaging service (MMS), such as Whatsapp, LINE, Viber, and WeChat. MMS is an evolutionary form of SMS; it can send not only text but also graphics, video, and audio clips (Tayebinik and Puteh; 2012). As multimedia instruction offers a more engaging and lively learning environment, designing English courses with the use of MMS seems to become an important issue. Several studies have compared the use of SMS and MMS in English learning and found MMS-based instruction to be more engaging and effective, which is in line with the Dual-Code Theory (Paivio, 1986) and the cognitive theory of multimedia learning (Gilakjani, 2012). For example, Yousefzadeh (2012) investigated how the uses of SMS and MMS via smart phones affect English vocabulary learning of 50 elementary level learners. Students in the MMS group received English vocabulary with definition, pictures and examples, while the SMS group received only English vocabulary with definition. The findings indicated that MMS had a substantially higher information-carrying capacity than SMS, and the achievement scores in the MMS group were significantly increased. Similarly, Chen, Hsieh, and Kinshuk (2008) pointed out that learners receiving English words along with both written and pictorial annotation via mobile messaging service had better learning outcomes than those receiving only English words without written or pictorial annotation. In other words, the use of visual media enhances English vocabulary acquisition.

Up to now, however, only few studies have explored how MMS affects foreign language learning. Previous research on SMS- or MMS-based English learning has tended to focus on having students passively receive instruction from the researchers or teachers via mobile phones, instead of interacting with their peers. According to one of the suggested principles for multimedia learning, "multimedia learning is more effective when it is interactive and under the control of the learner" (Gilakjani, 2012, p. 59). This means that MMS-based activities would be better received when learning through instant and interactive conversation.

Currently, LINE is one of the most popular MSM applications among young students in Taiwan. Launched in Japan in 2011, LINE is an app for instant messaging on smart phones and PCs. LINE is more of a social entertainment network, in addition to a messaging app. It provides free voice calls, instant text messages, games, and built-in camera. The cartoon characters and stickers serve as emoticons to make communication more interesting. It has become the most popular mobile messenger app in Taiwan, according to the market research of InsightXplorer Limited, as of May 2013. The official website of LINE pointed out that, as of the end of November 2013, the app had 300 million users worldwide; Taiwanese users of LINE had reached 17 million, second only to Japan (50 million) and Thailand (20 million), and most of the registered users are younger generation.

Due to the popularity of LINE, it is hoped that such technology can be leveraged to support English language learning. The purpose of the study attempts to explore how the use of MMS supports learning English reading by engaging students in interactive role-playing activities. This study is guided by the following research question: What the viability and challenges of LINE-based mobile learning are for English language education.

3. Methodology

3.1 The Research Context and Participants

This study is conducted at a university located in a suburban area of northern Taiwan. The participants involved in the study are 40 students who enrolled in the Freshman English Reading course in spring 2014. The 18-week course is offered by the Department of Applied English. The course is a required course with four credits for English majors and is scheduled four class hours per week.

3.2 Instructional Design

The Freshman English Reading course aims to help students understand and interpret English in its written form on a variety of topics. Students will comprehend written texts through use of reading and vocabulary learning skills. The instructional design consists of two elements: in-class instruction and after-class MMS-based activities.

Each week the course focuses on one reading text about themes such as earth science, tourism and hospitality, and animal studies. In-class instruction introduces vocabulary and language expressions to each theme. Some exercises for reading comprehension and reading skills will also be included for practices.

The MMS-based learning activities utilize the concept of Dual Code Theory (Paivio, 1986), which is designed to engage students in contextualized scenarios where students read, speak, write and interact with each other. Students form groups of three or four for the activity. Toward the end of each class, students receive role cards that explain their roles and tasks. They decide which role they would like to take on according to the role cards. Students then follow the tasks on the role cards to prepare for information, materials, etc. needed for their conversation.

After each class, students participate in the role-playing activities through LINE. Students are instructed to use what they have learned in class to communicate with their group members. They are also encouraged to include photos, video clips, links, or any information that will facilitate their communication. Figure 1 demonstrates the examples of LINE messages.

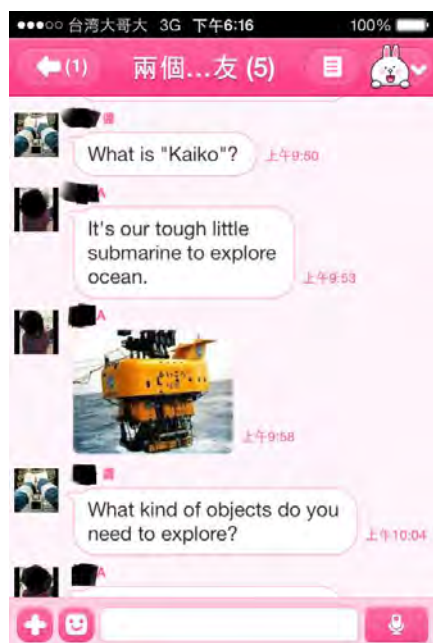

Figure 1. Example of LINE Messages

3.3 Implementation

The implementation include three elements: perform pre-test and post-test, implement the MMS-based activity, and conduct student questionnaire and interview. The study utilizes the pre-test and post-test design to examine students' English proficiency in Freshman English Reading course before and after the experiment. At the beginning of the semester (first week), the participants were asked to take a test of English reading (pre-test) to determine English proficiency level of the students. At the end of the semester (17th week), the participants will take the same test of English reading (post-test) to access their improvements during the experiment. Throughout the semester (2nd-16th weeks), the students are asked to participate in weekly role-playing activities after class using the vocabulary and language expressions introduced in class. At the end of the semester (17th-18th weeks), student perceptual questionnaire, and student group interview will be conducted. The students will be asked to fill out the student perceptual questionnaire in the last class of the course. Additionally, they will be invited to participate in group interviews for the researchers to further understand their experiences and reflection on the MMS-supported English learning.

3.4 Data Collection

Data collection consists of five sources: pre- and post-test, MMS messages, writing samples, student perceptual questionnaire, and group interviews with students. A pre-test is prepared to test the participants' proficiency level of English vocabulary and reading skills. The test consists of 30 items including multiple choice, cloze test, and single/double passage reading comprehension. The same test will be re-administered with the order of the items changed as a post-test.

All of the messages delivered via LINE during the weekly MMS-based activity are gathered. When students participate in the activity via LINE, they were asked to include the researcher's account in their conversation so that all the MMS messages can be recorded. Student writing assignments in relation to the MMS activities are collected. After students participated in the MMS activity, they wrote an assignment based on their discussion in the activity. The writing assignments were designed to strengthen students' understanding of vocabulary and reading texts learned in class.

The questionnaire design is used to identify students' learning experiences and reflections on MALL and MMS. It was designed to investigate the students' perceptions of group activity with MMS via smart phones. It comprises of two sections of questions: checked items and open-ended questions. A 5-point Likert scale ranging from 5 (strongly agree) to 1 (strongly disagree) is used in the checked questions, categorized into three aspects: technological device, MMS, and the role-playing activity. The open-ended questions asked the students about their learning gains benefited from the activity and

through technology, challenge encountered, self-reflection on the activity and technology, and suggestions to future teaching design.

All of the students will be invited to participate in the group interview at the end of the course. The semi-structured interviews will address four main questions: prior experiences with mobile- and MMS-based learning, current learning experiences, individual effort and group interaction, and overall reflection. Each interview will last about 30 minutes. All the interviews will be digitally recorded.

3.5 Data Analysis

The quantitative data will be processed with the statistical software, Statistical Package for Social Science (SPSS), including descriptive statistics, t-test, and correlation. Specifically, results obtained in the pre- and post-test will be compared in order to determine the effects of LINE on learning outcomes of English vocabulary and reading. For the student perceptual questionnaire, descriptive statistics will be performed; the mean scores and standard deviation of the questionnaire will be calculated to explore the participants' attitudes toward the use of mobile phone and the overall MMS. Word count will be used to analyze the MMS messages to assess student learning performance.

In addition, content analysis will be utilized to analyze qualitative data. Students' interview transcripts and responses to the open-ended questions will be analyzed using category construction (Erlandson et al., 1993) to code the data into emergent categories.

4. Preliminary Findings

As mentioned, this study is currently ongoing. The preliminary findings reveal that the students, overall, had positive perceptions of the MMS role-playing activities; many of them reported that the MMS role-playing activities helped them familiarize with new vocabulary introduced in class and hone their reading skills. In addition, LINE, as a learning platform, reportedly was convenient and fun to interact with peers. Based on the comparison of the students' pre- and post-test, the students who made conversation more frequently used more focus vocabulary in the role-playing activity and subsequently had better improvement in the test. Several challenges, however, were also reported, including (a) collaboration with group members who are not too responsive, (b) availability of teacher feedback, and (c) flexibility of time for instant conversation. More detailed description will be addressed upon the completion of the study.

5. Acknowledgement

This study was financially supported by the Research Grant MOST 103-2511-S-424-001-.

References

- Chen, N. S., Hsieh, S. W., & Kinshuk. (2008). Effects of short-term memory and content representation type on mobile language learning. *Language Learning & Technology*, 12 (3), 93-113.
- Gilakjani, A. P. (2012). The significant role of multimedia in motivating EFL learners' interest in English language learning. *IJ. Modern Education and Computer Science*, 4, 57-66.
- Greenfield, R. (2003). Collaborative e-mail exchange for teaching secondary ESL: A case study in Hong Kong. *Language Learning and Technology*, 7 (1), 46-70.
- Kiernan, P. J. & Aizawa, K. (2004). Cell phones in task based learning: Are cell phones useful language learning tools? *ReCAL*, 16 (1). 71-84.
- Paivio, A. (1986). *Mental representations: A dual coding approach*. Oxford, UK: Oxford University Press.
- Plass, J. & Jones, L. (2005). Multimedia learning in second language acquisition. In R. Mayer (Ed.), *The Cambridge handbook of multimedia learning* (pp. 467-488). New York, Cambridge University Press.
- Saran, M. & Seferoglu, G. (2010). Supporting foreign language vocabulary learning through multimedia messages via mobile phones. *H. U. Journal of Education*, 38, 252-266.
- Shuell, T. J. & Farber, S. L. (2001). Students' perceptions of technology use in college courses. *Journal of Educational Computing Research*, 24, 119-138.
- Yousefzadeh, M. (2012). Multimedia messaging service (MMS) vs. short message sending (SMS) and second language learners' vocabulary. *Journal of Educational and Instructional Studies in the World*, 2 (4), 89-92.

Gender Differences in Flow State in an English Learning Environment Achievement System

Benazir QUADIR, Jie Chi YANG* & Yin-Hsuan CHEN

Graduate Institute of Network Learning Technology, National Central University, Taiwan

*yang@cl.ncu.edu.tw

Abstract: In recent years, a growing number of studies have been conducted on the individual differences in digital game-based learning (DGBL). Despite this growing interest, there is a lack of sound empirical evidence on individual differences (e.g., gender differences) in flow state in achievement systems in English learning environments. This study investigated whether any gender differences existed in such a system. To this end, the current study developed an achievement system including a reward mechanism-based design with learning features (i.e., interaction and rewards for correct answers) to facilitate English learning. An experiment was conducted. A total of 50 respondents participated in the study. Data were analyzed using independent sample t-tests. The results revealed that the female respondents had significantly higher mean scores for flow state than the males.

Keywords: Achievement system, English learning, flow state, gender, reward mechanism-based design.

1. Introduction

Recently educators have focused on digital game-based learning (DGBL) for language learning. In authentic use, however, the perception of flow state in the digital games used in the foreign language classroom remains limited for individual learners. Individual differences could be caused and sharpened by a learner's average intelligence, special ability, gender, and so on. The increasing individual differences make DGBL systems more difficult to design for each English language learner.

Numerous studies have attempted to explain the benefits of digital games in learning (Ronimus, Kujala, Tolvanen, & Lyytinen, 2014). For example, during play, children practice skills (De Grove, Bourgonjon, & Van Looy, 2012) and actively solve meaningful problems (Price & Rogers, 2004).

Recently, researchers have begun to focus on the elements that comprise game-based learning (Wilson et al., 2009) such as achievement-based reward systems, and rewards and achievement associated with game rules (Charles, Charles, McNeill, Bustard, & Black, 2011) that provide missions and objectives to challenge players for rewards. Rewards are a kind of positive feedback which encourage the player to continue the game, and providing fun and experience (Wang & Sun, 2011).

One fundamental aspect that is often included in the "rewards based mechanism" of a game is the ability of the game to create a flow state for the gamer. Potential control is one of the antecedents of flow (Finneran & Zhang, 2003) which leads to improved learning outcomes (Skadberg & Kimmel, 2004) by achieving a reward. In addition, Wang and Sun (2011) mentioned that flow state is generally used to analyze the rewarding experience of the learner. They used three of the characteristics of flow state to analyze how reward systems offer positive experiences: balance between challenge and skill, clear goals, and immediate feedback. In addition, different players have different flow states during a game. For example, different genders' performance differs while playing. Boys tend to focus on the achievements whereas girls are more likely to be concerned with building relationships with other players (Williams, Consalvo, Caplan, & Yee, 2009).

The current study designed an achievement system including a reward mechanism (i.e., expected and unexpected rewards) for a game-based English learning environment, with the aim of investigating whether there were any gender differences in the flow state while using the system.

2. Literature review

2.1 Gender differences

Numerous studies have been conducted to explore the effect of gender differences on performance in games. Wood, Griffiths, Chappell, and Davies' (2004) study found significant gender differences in relation to some of the game dynamics such as males rating skill development significantly higher, and preferring shooting and a variety of different forms of transportation within a game compared to females. On the other hand, significantly more females preferred solving puzzles, avoiding things (e.g., dangerous places, spells), and finding important things, and were more in favor of points accumulation than males. Inal and Cagiltay (2007) mentioned that gender differences played an important role in children's game preferences. They found that boys preferred fighting or war games whereas girls preferred Barbie-like games. Heeter, Lee, Medler, and Magerko (2011) found gender differences in an achievement system. For example, boys generally emphasize performance and super-achievement, while on the other hand, girls are more likely to be classified as non-achievers, with low performance and mastery gaming achievement goals. They are also less motivated by exploration or achievement. Females are more likely to prefer to play alone, and dislike competing to outplay other players.

2.2 Flow state within an achievement system

The present study defined flow state as one's engagement, fun/enjoyment and control while participating in an achievement system. Previous work has proposed that these indicators (engagement, enjoyment, and control) can be used to provide an overall impression of flow while learning (Trevino & Webster, 1992). A flow activity is one in which the mind becomes easily focused and engaged in an activity and learning (Whitson & Consoli, 2009), which makes it of particular interest to the serious games community, for whom engagement and learning are key concepts. Thus, engagement in an activity is a fundamental aspect of flow experience, setting the foundation for continuing learning. Other flow activities, including intellectually demanding tasks, can also be enjoyable and satisfying, and can enhance creative accomplishment and satisfaction. Such feelings may occur mainly in retrospect because all concentration is focused on the task during actual engagement (Csikszentmihalyi, Kolo, & Baur, 2004). One's potential control leads to improved learning outcomes (Skadberg & Kimmel, 2004).

In this study, we use the concept of flow (Csikszentmihalyi et al., 2004) in an achievement system including a reward mechanism which allows learners to continue their English learning activities. Moon, Jahng, and Kim (2011) argued that the reward system in a game is recognized as one of the most important mechanisms to engage players in active sustainable digital game playing. As Chen et al. (2009) proposed a game-based learning system including learning features such as being competitive, interactive, and visible, to design a reward mechanism-based trading card game, which was used to stimulate learners' motivation and increase their willingness to use it. The current study developed an achievement system including a reward mechanism to see whether gender differences have any impact on learners' perceptions of flow state within the proposed system.

3. Research method

3.1 System design and implementation

There are two parts to the achievement system design, the architecture of the system and English learning activities. The descriptions of these two parts are given below.

3.1.1 Architecture of the achievement system

In the achievement system, the rewards can be divided into two categories, that is, expected and unexpected reward achievement. Expected reward achievement allows learners to obtain the game goal, which is one of its criteria. For unexpected reward achievement, learners are faced with different

challenges. Once they can tackle the different situations in the game, they will have rewards and enhance their gaming experience.

There are two kinds of expected rewards, learning rewards and interactive rewards, where learning rewards are gained by answering multiple choice questions and completing problem sets. In this design, the learning rewards are designed to encourage the learners to answer the questions so as to gain the desired rewards. The more questions that are answered correctly, the better ranking will be achieved along with gaining the rewards. Interactive rewards consist of playing ball, jump rope and shopping. The design of these interactive rewards allows learners to try a variety of games in the achievement system which will enhance their gaming skills. Thus, they are not only able to develop their gaming skills, but can also buy things. For the unexpected rewards, there are three kinds of reward achievement, namely teaching, mastering, and collecting. Thus, learners will become familiar with the system through achieving rewards. After finishing the game and fulfilling the reward requirements, the learner will get immediate feedback, as shown in Table 1. This feedback system helps students to understand their gaming goals. In this way, learners will be motivated to pursue a variety of challenging goals in the game as well as enhancing English learning. In this system there are many criteria such as progressive achievement, which is designed for the learners to face the challenges of similar tasks with many difficulties. Progressive achievement provides status rewards including gold, silver and bronze rewards. In the game, the learner needs to achieve bronze, then silver, and finally gold. The different levels of icon are shown in Table 1.

Table 1: After achieving reward with different levels of reward icon

			Bronze		Silver		Gold	
Expected	Learning	MCQ-1	Stone+2		Stone+2		Stone+3	
		MCQ-2	Stone+3		Stone+3		Stone+4	
	Interactive	Play ball	Power+5		Power+10		Power+15	
		Jump rope	Power+5		Power+10		Power+15	
		Buy something	Money+50		Money+100		Money+150	
Unexpected	Understand game	Teach	Water+1					
		Master	Money+300					
		Collect	Money+500					

3.1.2 English learning activities

After logging the game, the learners are able to see the English learning content which is consist of alphabets, words and sentences. These three contents were chosen because language learning starts with lower to higher-level representations. The exercises of the learning content are designed as multiple choice questions (MCQ) and problem sets. In the process of learning activities there were a total of 360 questions where learners need to practice. Participating MCQ a learner can achieve different virtual reward and feedback. Rewards are provided by performing English learning activities from the English learning contents of the system.

Hamari and Eranti (2011) mentioned that game rewards can affect players' performance. In the achievement system design an English learner can have a reward which is visible on the screen, as shown in Figure 1(a). The system shows the rewards in words and pictorial representation. Therefore, learners may choose their desired rewards. Before they get the reward, it is shown in dark on the screen. After receiving the reward the color will change to bright. Then, learners can take challenges to win more difficult rewards by performing English learning activities. Once they finish the challenge, the system will inform the learner of their completion of the goals and of the rewards they have gained. The

achievement system will show the rewards they have acquired by English learning, as in Figure 1(b). Learners can see the acquired rewards, the grade and the quantity of rewards. The learners could then prepare for the next challenge in the game.

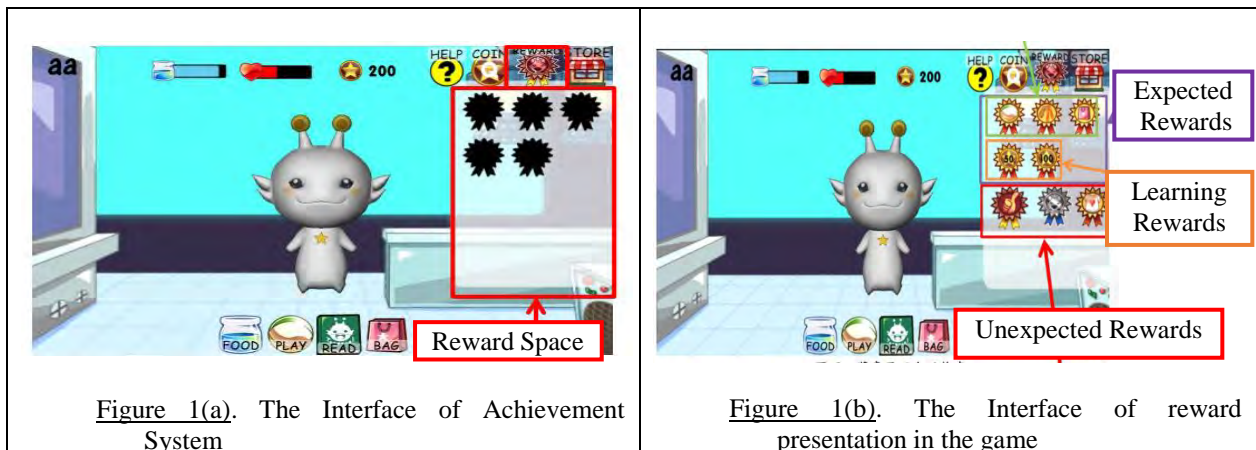

Figure 1. Achievement system screen

3.2 Instruments

There are two kinds of research tools used in this study. Table PCs were used as the hardware, and a questionnaire was developed to survey the learners' flow state performance while using the achievement system. A total of 11 question items were developed for identifying the players' flow state. The questionnaire was adapted from Pearce, Ainley, & Howard, (2005), and was slightly modified to fit the present study context. There were four questions for control, four for fun (enjoyment) and three for engagement. Each item was rated on a five-point Likert scale, ranging from 1 (strongly disagree) to 5 (strongly agree). The Cronbach's alpha for the flow state items was .82.

3.3 Participants and procedure

The questionnaire was distributed to third grade students of an elementary school in northern Taiwan, in a paper-based format. A total of 53 students participated in this study, three of whom did not complete the questionnaire, giving a valid sample of 50 (94%). There were 26 (52%) males and 24 (48%) females. The respondents were 9 to 10 years old.

An experiment session was conducted once a week for two times. The total time of the three experiment sessions was about 140 minutes. The students were first introduced to the features and usage of the system including the tablet and the game with the achievement system. The researchers then guided the students through all of the different types of English learning activities. The students took turns test driving the system, and their reactions to and interactions with the system were captured.

4. Results

4.1 Learner's activity on achievement system and gender differences in the use of the achievement system

Activity on achievement system and the results of the t-tests are presented in Table 2. As can be seen, the female respondents' number of view times is higher than that of the males. Independent sample t-tests were used to compare the differences between the male and female learners in their use of the achievement system and flow state. In Table 2, the results portray that the male respondents had higher mean scores for interactive rewards, learning rewards, unpredictable rewards and total number of rewards than the females. The t-test results show that the difference between the males and females for the interactive dimension's mean score was significant ($t = 2.10, p < 0.05$) but for the other values it was not. Compared to the female (5.29) respondents, the males (6.04) achieved more interactive rewards in the achievement system.

Table 2: Achievement system of each variable

Variable	Gender	Number of respondents	Maximum	Minimum	Mean	SD	t
Number of view times	Male	26	35	1	21.38	9.87	-0.01
	Female	24	51	5	21.42	12.83	
Interactive rewards	Male	26	8	4	6.04	1.00	2.10*
	Female	24	8	1	5.29	1.46	
Learning rewards	Male	26	6	3	4.38	0.85	0.47
	Female	24	6	2	3.25	1.15	
Unpredictable rewards	Male	26	3	2	2.65	0.49	0.46
	Female	24	3	1	2.58	0.58	
Total number of rewards	Male	26	16	9	13.08	1.70	1.45
	Female	24	16	4	12.21	2.45	

4.2 Gender differences in the flow state in the achievement system

In Table 3, the results portray that the female respondents had higher mean scores for flow state than the males. The t-test results showed that the difference between the males and females in the flow state dimension’s mean score was significant ($t = -2.50, p < 0.05$). Compared to the male (46.28) respondents, the females (49.42) were more involved in the pursuit of the goal rewards in the achievement system.

Table 3: Gender differences in the flow state

	Gender	Number of respondents	Mean	SD	t
Flow state	Male	26	46.28	5.35	-2.50*
	Female	24	49.42	3.38	

* $P < .05$

5. Discussion and conclusion

The results of this study showed that gender differences played a significant role in predicting individuals’ flow state, and that the female respondents had higher mean scores for flow state than the males. Taken together, these findings affirm the predictive power of the gender role theory, and highlight the importance of including gender as an independent variable in future work among game-based learners.

The several findings will be covered individually, followed by a discussion of the related theory. At the broadest level, the findings support past research (Wood et al., 2004) which has found that more females than males prefer accumulating points and finding bonuses. In this study, one of the features of the achievement system, “buying clothes,” influenced girls’ behavior more than boys’ and enhanced the girls’ contribution to the game, while the boys were easily influenced by other factors of the game. In addition, when the learners could see their game ranking among all learners, they were more competitive and discussed the game with others, which enhanced their motivation and accomplishment of the goal. As predicted, the male students achieved more interactive rewards than the females, and there was a significant difference while interacting with special characters, such as aliens. Our results are quite similar to those of Heeter et al.’s (2011) study in which they found that males were significantly more likely than females to be super-achievers while interacting. Thus, interaction is needed as they found that interaction was high among group members when the learners found a new game or after they achieved a given task in a game. While interacting, Inal and Cagiltay (2007) mentioned that flow experience mostly occurs among group members while they are working on difficult levels of a game and after they pass to the next level. Their results revealed that flow experience occurs more often among boys than girls during gameplay, which is quite similar to the interaction part of this study.

One of the limitation of this study is the experiment time was short (i.e., only two times), due to their regular classes, school activities, school examinations and a time limit on the game play. It is

suggested that future research could allocate more time for the experiment; then, the understanding of learners' perceptions of flow state in an achievement system for learning English will be better. One of the implications of this study is that educators could be better informed to think about how to leverage the differences in individuals' to come up with better pedagogical DGBL designs to improve their students' English learning performance.

Acknowledgements

The authors would like to thank all the subjects who participated in the study. This study was partially supported by a grant (NSC 102-2511-S-008-003-MY3) from the National Science Council of Taiwan.

References

- Charles, D., Charles, T., McNeill, M., Bustard, D., & Black, M. (2011). Game-based feedback for educational multi-user virtual environments. *British Journal of Educational Technology*, 42(4), 638-654.
- Chen, P., Kuo, R., Chang, M., & Heh, J.-S. (2009). Designing a Trading Card Game as Educational Reward System to Improve Students' Learning Motivations *Transactions on Edutainment III* (Z.Pan et al. ed., pp. 116-128). Verlag Berlin Heidelberg: Springer.
- Csikszentmihalyi, M., Kolo, C., & Baur, T. (2004). Flow: The psychology of optimal experience. *Australian Occupational Therapy Journal*, 51(1), 3-12.
- De Grove, F., Bourgonjon, J., & Van Looy, J. (2012). Digital games in the classroom? A contextual approach to teachers' adoption intention of digital games in formal education. *Computers in Human behavior*, 28(6), 2023-2033.
- Finneran, C. M., & Zhang, P. (2003). A person-artefact-task (PAT) model of flow antecedents in computer-mediated environments. *International Journal of Human-Computer Studies*, 59(4), 475-496.
- Hamari, J., & Eranti, V. (2011, September, 14-17). *Framework for designing and evaluating game achievements*. Paper presented at the Proc. DiGRA 2011: Think Design Play, Hilversum, Netherlands.
- Heeter, C., Lee, Y.-H., Medler, B., & Magerko, B. (2011). *Beyond player types: gaming achievement goal*. Paper presented at the Proceedings of the 2011 ACM SIGGRAPH Symposium on Video Games.
- Inal, Y., & Cagiltay, K. (2007). Flow experiences of children in an interactive social game environment. *British Journal of Educational Technology*, 38(3), 455-464.
- Kapp, K. M. (2012). *The gamification of learning and instruction: game-based methods and strategies for training and education*: John Wiley & Sons.
- Moon, M.-K., Jahng, S.-G., & Kim, T.-Y. (2011). Computer- Assited Learning Model Based on The Digital Game Exponential Rewards System. *Turkish Online Journal of Educational Technology*, 10(1), 1-14.
- Pearce, J. M., Ainley, M., & Howard, S. (2005). The ebb and flow of online learning. *Computers in Human behavior*, 21(5), 745-771.
- Price, S., & Rogers, Y. (2004). Let's get physical: the learning benefits of interacting in digitally augmented physical spaces. *Computers & Education*, 43(1), 137-151.
- Ronimus, M., Kujala, J., Tolvanen, A., & Lyytinen, H. (2014). Children's engagement during digital game-based learning of reading: The effects of time, rewards, and challenge. *Computers & Education*, 71, 237-246.
- Skadberg, Y. X., & Kimmel, J. R. (2004). Visitors' flow experience while browsing a Web site: its measurement, contributing factors and consequences. *Computers in Human behavior*, 20(3), 403-422.
- Trevino, L. K., & Webster, J. (1992). Flow in computer-mediated communication electronic mail and voice mail evaluation and impacts. *Communication research*, 19(5), 539-573.
- Wang, H., & Sun, C.-T. (2011). Game reward Systems: gaming experiences and social meanings. *Research Paper, Department of Computer Science, National Chiao Tung University, Taiwan*.
- Whitson, C., & Consoli, J. (2009). Flow theory and student engagement. *Journal of Cross-Disciplinary Perspectives in Education*, 2(1), 40-49.
- Williams, D., Consalvo, M., Caplan, S., & Yee, N. (2009). Looking for gender: Gender roles and behaviors among online gamers. *Journal of communication*, 59(4), 700-725.
- Wilson, K. A., Bedwell, W. L., Lazzara, E. H., Salas, E., Burke, C. S., Estock, J. L., . . . Conkey, C. (2009). Relationships between game attributes and learning outcomes review and research proposals. *Simulation & Gaming*, 40(2), 217-266.
- Wood, R. T., Griffiths, M. D., Chappell, D., & Davies, M. N. (2004). The structural characteristics of video games: A psycho-structural analysis. *CyberPsychology & behavior*, 7(1), 1-10.

MULTIMEDIA DEVELOPMENT OF ENGLISH VOCABULARY LEARNING IN PRIMARY SCHOOL

Syaiful ROHIM^{a*} & Lina YULINDA^{a**}

^{a*}University of Muhammadiyah Prof. DR. HAMKA (UHAMKA), Indonesia

^{a**}Bakti Mulya Senior High School, Indonesia

*aimmacan@gmail.com

**yulindalina@yahoo.com

Abstract: This research study is aimed at: (1) developing multimedia of English vocabulary instruction in year-five of the elementary school, (2) revealing the quality of the developed instructional multimedia viewed from the aspects of content, instruction, appearance, and programming, (3) revealing the aspect of attraction of the developed instructional multimedia, and (4) revealing the learning mastery of the students after using the developed multimedia. This study was developmental research. The research validators included one expert in English education and one expert in instructional multimedia. The research subjects consisted of three students for the one-to-one try-out and twenty students for the large group try-out. The instruments employed in this study were a questionnaire, observation guide, and pre-test and post-test. The data were analyzed by using descriptive statistics. The findings of the study are: (1) the development of English vocabulary instructional multimedia in year-five of the elementary school proceeded in six steps, namely, analyzing, designing, producing, validating, revising, and trying-out; (2) the quality of the developed instructional multimedia viewed from the aspect of content, instructional, appearance, and programming is good. The score range of 1 to 5, the content aspect shows a mean score of 3.75, the instructional aspect shows a mean score of 3.71, the appearance aspect shows a mean score of 3.87, and the aspect of programming shows a mean score of 3.75; (3) the aspect of attractiveness shows that the developed instructional multimedia was very interesting: in the one-to-one tryout, of the three students observed, two students indicated that the product attraction was very interesting, and one student indicated that the product attraction was interesting; in the large group try-out, of the twenty students observed, twelve students indicated that the product was very interesting, and eight students indicated that the product was interesting; and (4) learning by using instructional multimedia has good impact on students' mastery learning: in the large group try-out, out of twenty students, nineteen students (95%) have accomplished mastery learning in the English vocabulary instruction.

Key words: development, multimedia, vocabulary

1. Introduction

English learning in primary school during this time is still using conventional method. In teaching the teacher only rely on the classical lecture method. The teacher is not using the other media besides book. Learning methods like this does not fulfill the principles of effective learning and empowering the students potential. Based on the statements above, both teachers and students in primary schools are needed to innovate the instructional media. Basically the media is supporting facilities which are used in teaching so that educators can transfer the material easier. In using the media we must see what things that we are going to give to the students. The instructional media innovation is used to improve the quality of learning.

One of the products of technology that can be used as an innovation in learning is computer. As it is said by Ruseffendi (1984:420) that, learning media which is based on the computer can make the students' behavior become positive. One of the advances in information technology and communication is multimedia. Molenda said that today examples of multimedia education and training include slides with synchronize audio tapes, videotapes, cd-roms, dvd, the worldwide web, and virtual reality (Molenda, 2005:141). By using multimedia it is expected children more interested in knowing the information. The more quality applications from the media, the more children have a lot of variety in learning so that the learning activities will be no bored, especially in English. English as one of the education which is provided to children will be delivered easily to the child by using

multimedia. Introducing English from an early age children are expected can master and communicate by using the English language. Multimedia can be used to support the learning process.

2. Multimedia

According to Barker & Tucker (1990) multimedia is defined as a collection of various different media equipment used for presentations. Tan Seng Chee & Angela FL Wong (2003: 217) states that traditionally multimedia refers to the use of multiple media, whereas in today's multimedia refers to the combined use of multiple media in the presentation of learning through computers. Hackbarth (1996: 229) emphasizes that hypermedia and hypertext, including computer-based interactive multimedia. Philips (1997: 12) states that interactive multimedia has potential to create a multisensory environment that supports a particular way of learning.

Agnew, Kellerman & Meyer (1996: 8) states that the term multimedia is more focused on the interactivity between the users of the media with the media. Constantinescu (2007: 2) states that "Multimedia Refers to computer-based systems that use various types of content, such as text, audio, video, graphics, animation, and interactivity". Multimedia which is developed in this study is a multimedia in English vocabulary learning for the fifth grade of primary school. This study develops a tutorial model of learning multimedia that can be used in learning both classical and individually. The language learning on the aspects of English vocabulary learning in this study is based on one of the characteristics of elementary school student Schematic of the multimedia components can be seen from the figure below:

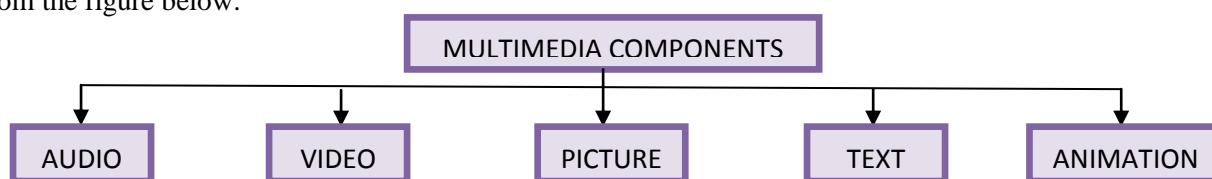

Figure 1. Schematic picture of Multimedia Components

3. Vocabulary

Abu Bakar Suleiman, A. Gani & Syafri K. (1986: 6) states that the word is derived from Sanskrit vocabulary *Koca* and *katha*. Both words are absorbed into Indonesian as a compound word. Without extensive vocabulary, a person will not be able to use the structure and function of language in communication in a comprehensive manner. Tarigan (1986: 2) states that a person's language quality depends on the quality of the language vocabulary possessed. The richer vocabulary possessed, the greater in using the language.

One of the reasons why teachers learnt vocabulary is to facilitate the students in improving reading comprehension (Pikulski & Templeton, 2004: 5). Knowledge of vocabulary is the center of expertise in the language. Therefore, learning vocabulary is something that is very important. Learning vocabulary in this case concerns the teaching and learning vocabulary. Nation (2001: 107-108) mentions three procedures of vocabulary teaching, namely: recycled words, the second-hand cloze, and the vocabulary interview.

4. The using of Multimedia in Vocabulary Mastery

English vocabulary mastery is really important in order to communicate something, if someone choose the wrong vocabulary in a sentence it will give significant effect to the sentence, as stated that "Research has shown that lexical errors tend to impede comprehension more than grammatical errors, and native speaking judges tend to rate lexical errors as more serious than grammatical errors" (Schmitt, 2000:155). Mastery of vocabulary also obtain for the native speakers' themselves. So it can be said that someone has mastered the vocabulary if a learner can communicate with someone effectively. According to Wood (2001: 15), the use of multimedia learning has potential to improve learning vocabulary. In multimedia learning can be presented in the form of games, hyperlinks, hypertext, and animation.

5. RESEARCH METHODOLOGY

This research is a developing research. According to Borg&Gall (2003:772), the development of research is oriented research in developing and validating the product which is used in education. The same thing also expressed by Gay (1981: 10) that development research is not to create a theory or test the theory but to develop effective products to be used in school.

In this study, model which suitable is a model of research development Borg & Gall (2003: 775) and the development model of instructional design Dick, Carey & Carey (2005: 1). The development model adapted to produce a simpler model of development, which serve as a foundation in research.

This research through six phases as the following. First is the requirement analysis phase. The purpose in this stage is to collect information which is relevant with the requirement for the development of multimedia learning English vocabulary of fifth grade elementary school. The second is the instructional design development. The purpose in this stage is to develop the instructional design to produce a syllabus as a basis for developing multimedia learning. The third is the stage of production or multimedia development. The purpose in this stage is to produce the initial product, and subsequently tested or implemented in a computer to determine if the results are expected or not. Fourth is the expert validation stage. This stage is to determine the feasibility of the product which is developed. Fifth is revised. This stage is to improve the quality of products based on the suggestions from the material experts revision and media experts. Sixth is to test the product. This phase was conducted to determine the attractiveness of multimedia which is developed for students and to get the results of pre-test and post-test.

Validator of the study consisted of one person material experts and a media expert. The material expert is assessing the content aspects and learning; media experts is assessing the aspects of the display and programming. Subject of research is the students of Elementary School fifth grade in SD Bakti Mulya 400 numbered twenty-three students. In one-on-one trials involving three students consisting of two male students and one female student. While the trial involves a large group of twenty students is seven boys and thirteen girls. The age of students who take the test ranged from 10 to 12 years.

The data collection instrument which is used was a questionnaire, observation, pre-test and post-test. Questionnaire was used to obtain the data which is related to the quality of materials and quality of media feasibility. Observation is used as a guide in making observations on the attitudes of the students during the process of testing to determine the attractiveness of the product for students. The pre-test and post-test was used to determine the students' mastery learning after using the multimedia products which is developed.

The type of the data in this study is qualitative and quantitative. Data was analyzed by descriptive statistics. Qualitative data in the form of comments and suggestions for improvement of the products and materials experts and media experts described descriptively analyzed qualitatively to revise the products developed . Quantitative data is a data in the form of material expert assessment and media experts , the results of observation scores , and the results of pre - test and post - test . Quantitative data analysis is described as follows. first , quantitative data of material expert assessment scores and media experts which is analyzed descriptively with the reference from conversion table which is adapted from Sukardjo (2005 : 53-54). It is present in the table 1 as follow:

Tabel 1: Quantitative Data Conversion to Qualitative with 5 Scale

Value	Score Interval	Criteria
A	$X > 4,21$	Excellent
B	$3,40 < X \leq 4,21$	Good
C	$2,60 < X \leq 3,40$	Enough
D	$1,79 < X \leq 2,60$	Not enough
E	$X \leq 1,79$	Fair

Note:

Ideal Maximum Score= $5 X i = \frac{1}{2}(5+1) = 3$

Ideal Minimum Score= $\frac{1}{6}(5-1) = 0,67$

Second , quantitative data of product appeal observation results is converted into qualitative data based on the conversion value adapted from Sukardjo (2005 : 53-54) .

Table 2: Quantitative Data Conversion to Qualitative Data for Development of The Media

Value	Score Interval	Criteria
A	$X > 12,806$	Very Interesting
B	$9,602 < X \leq 12,806$	Interesting
C	$6,398 < X \leq 9,602$	Interesting enough
D	$3,194 < X \leq 6,398$	Less interesting
E	$X \leq 3,194$	Very Uninteresting

Note:

Maximum Score = $1 \times 16 = 16$ $X_i = \frac{1}{2} (16 + 0) = 8$

Minimum Score = $0 \times 16 = 0$ $S_{Bi} = \frac{1}{6} (16 - 0) = 2,67$

X = Actual Score

Third , the data of pre-test score and post-test were analyzed by calculating the percentage of students who have obtained a score of 70 and change the percentage of mastery learning quantitative data into qualitative data.

Table 3: Learning Completeness Percentage Conversion to Qualitative Data

Percentage (%)	Criteria
$90 \leq X$	Excellent
$80 \leq X < 90$	Very Good
$70 \leq X < 80$	Good
$60 \leq X < 70$	Less
$X < 60$	Fair

6. RESULT AND DISCUSSION

The development of multimedia products in English vocabulary learning of fifth grade primary school begins with requirement analysis, instructional design development, product development, expert validation, product revisions, and then product trials. Based on the steps, it has been produced the research data which is become the results and discussion of the research, namely: the results of the data expert validation, observation data, and data from the pre-test and post-test. The research results will be discussed as follows.

a. Data of Expert Validation

Data of Expert validation is data obtained based on the expert material assessment and media experts through questionnaires. Material experts assess the content and the learning aspect, media experts assess the aspects of display and programming. After analysis, it is obtained that the average scores from material expert 3.75 and 3.71 for the aspect of learning. By using the score range of 1 to 5, the average assessment scores of material expert for content aspects and learning according to the conversion guidelines 5 scale is classified as a good criteria. Meanwhile, the average scores of media experts for display aspect 3.87 and programming aspects of 3.75. The average scores of media experts for display aspect and programming aspects classified as a good criteria. With the results above, it was concluded that multimedia learning English vocabulary fifth grade elementary feasible to use in learning both in content aspect and learning or aspects of the display and programming aspects for obtaining the scores average overall "B" or classified criteria "Good ". This conclusion is accordance with the values specified in the feasibility of this research that when the material experts and media experts give a minimum scores "C" or by the criteria of "enough", the products which is developed are considered feasible to use in learning.

b. Data Observations

Based on the test results one by one, it is known that two of the three students show their interest on the multimedia which is developed in the criteria "very interesting", while a student shows the attractiveness of the media on the criteria of "interesting". In a large group it is known that twelve students from twenty students were observed shows the attractiveness of the product on the criteria of "very interesting". While eight students show the attractiveness of the product in the criteria of "interesting". Attractiveness criteria is derived based on the conversion of quantitative data to qualitative data according to a scale of 5 Sukardjo (2005: 53-54).

With the results of the trial one-on-one and large group trials, we can conclude that the products which is developed "very interesting". This conclusion is gotten because more than half of the students indicated the attractiveness of products are on the criteria of "very interesting".

c. Data Results Pre-test and post-test

The purpose of pre-test and post-test is to obtain the students' data score to determine the student's mastery learning after using the product which is developed. Based on the minimum value of mastery learning standards that has been established is 70, it is known that in a large group test of 20 students, there are 19 students who complete in learning English vocabulary and only one student who did not complete learning English vocabulary. Thus, the percentage of mastery learning students is $19: 20 \times 100\% = 95\%$. Furthermore, the percentage of this completeness is converted into qualitative data to determine the criteria. By referring to the percentage conversion of learning mastery becomes qualitative data, it is known learning mastery learning is 95% the criteria is "Excellent". With these results, it can be concluded that English vocabulary learning multimedia in fifth grade elementary gives positive impact on students' mastery learning and facilitate the students to learn English vocabulary.

7. CLOSING

The result of development research can be summarized as follows. First, the development of multimedia in English vocabulary learning in fifth grade elementary school has been done through six stages, namely: conducting requirement analysis, developing instructional design, developing learning multimedia product, validating the expert, doing a revision, and conducting trials.

Secondly, if it seen from content aspect and learning aspect, the quality of multimedia which is developed the rated is "good" by the material expert. The "good" criteria is known through 5 scale score conversion table. The average of assessment score of material expert in content aspect is 3,75 and The average of assessment score of material expert in learning aspect is 3,71.

Third, if it seen from the display aspect and programming aspects, the quality of learning multimedia which is developed the rated is "good" by media experts. Media experts give an assessment in display aspect with average score 3,87 and programming aspects with an average score 3,75.

Fourth, based on the observation, it was concluded that the attractiveness of the product is "very interesting", because more than half of the students stated that the product is "very exciting". The attractiveness criteria is identified through conversion guidelines table of quantitative data to media's fascination which is developed.

Fifth, the use of multimedia has a positive impact on students' mastery learning. From twenty students who had followed the trial in a large group of students there is one student who did not complete learning English vocabulary and 19 students (95%) completed the study with an average score of 16.25 or 81.25 from maximum score of 100. Mastery learning is classified as "Excellent".

Acknowledgements

We would like to thank for all the people that support this paper. We hope that this paper can give a great contribution especially in Information, Communication and technology for education.

Authors

SYAIFUL ROHIM is a senior researcher from University of Muhammadiyah Prof. Dr. Hamka (UHAMKA) Indonesia, Doctoral of Political and Communication.

LINA YULINDA is an English teacher from Bakti Mulya Senior High School with a lot of experience in teaching by using ICT

References

- Agnew, P. W., Kellerman, A. S. & Meyer, M. J. (1996). *Multimedia in the classroom*. Boston: Allyn and Bacon.
- Borg, W. R. & Gall, M. D. (2003). *Educational research: an introduction (7th ed.)*. New York: Longman, Inc.
- Constantinescu, A. I. (2007). Using technology to assist in vocabulary acquisition and reading comprehension. *The Internet TESL Journal, Vol. XIII, No. 2, February 2007*
- Dick, W., Carey, L. & Carey, J. O. (2005). *The systematic design of instruction*. Boston: Harper Collin College Publisher.
- Gay, L. R. (1981). *Educational research: Competencies for analysis & application. (2nd ed.)*. Columbus: Charlie E. Merrill Publishing Co.
- Hackbarth, S. (1996). *The educational technology handbook: A comprehensive Guide*. Englewood Cliffs: Educational Technology Publication, Inc.
- Molenda, M. Smaldino, Sharon E, dkk (2005). *Instructional Technology and Media For Learning*. New Jersey: Pearson Merill Prentice Hall
- Nation, I. S. P. (2001). *Learning vocabulary in another language*. Cambridge: Cambridge University Press.
- Philips, R. (1997). *A practical guide for educational applications*. London: Kogan Page limited.
- Pikulski, J. J. & Templeton, S. (2004). *Teaching and developing vocabulary: key to long-term reading success*.
- Ruseffendi (1984). *Dasar-dasar Penelitian Pendidikan dan Bidang Non Eksakta*.
- Tan Seng Chee & Angela F. L. Wong (Eds.) (2003). *Teaching and learning with technology: An asia-pacific perspective*. Singapore: Prentice Hall.
- Tarigan, H. G. (1986). *Pengajaran kosakata*. Bandung: Penerbit Angkasa.

Online Manga and Anime in Promoting Language Learning and Literacy Practices

Abu Bakar RAZALI (PhD)

Faculty of Educational Studies, Universiti Putra Malaysia (UPM), Malaysia

mr_bakar@upm.edu.my

Abstract: The field of language learning and literacy education is vast and ever expanding. New and hybrid literacies are always given birth to within and outside the field of education, in particular the Internet realm. With the reach of the online medium these new literacies has expanded for the consumption and production of people all over the world. More often than not, these forms of new literacies develop through the consumption and production of the many popular cultures within the Internet. Realizing the importance of these new literacy practices, a number of scholars have studied the impacts, roles, and potentials of these online popular cultures with relations to language learning and literacy education. Two of the more recent areas within the sphere of online popular culture being studied by literacy scholars are the consumption and dissemination of online manga and anime. This conceptual paper analyzes several key academic papers (i.e., commentaries, conceptual papers, research studies, etc.) published thus far on the use of online manga and anime in the field of language learning and literacy education. In doing so, the author discusses briefly the notions of New Literacies Studies and Multimodality in the use of online manga and anime in language learning and literacy education. The author also discusses a brief background of manga and anime; the roles and potentials of these genres as representation of universal culture and in promoting literate practices; and the issues or problems with online manga and anime in the field of language learning and literacy education. The author offers views, recommendations, and implications for the use of online manga and anime in the field of language learning and literacy research.

Keywords: Anime, English as a second language (ESL), language learning, literacy practices, manga, multimodality, New Literacies Studies.

1. Introduction

Manga and anime are forms of popular culture that derive from Japan, and they both are very popular, especially among young adults. The hype and enthusiasm for manga and anime is tremendous not just in Japan, but throughout the world (Black, 2005). In the past two decades, manga and anime have become major forces in global popular culture, resulting in which, they have begun to receive more scholarly attention mostly from the standpoint of popular culture study (Moist & Bartholomew, 2007). Scholarly works on manga and anime too has expanded beyond popular culture studies to include studies on education, most notably on language learning or literacy education (Bryce et al., 2008). This is due to the fact that many manga and anime enthusiasts create and maintain online fan sites, such as online discussion boards, forums, chat rooms, events, and many more online social networking activities in sharing their love for manga and anime (Black, 2005). All of these activities in fact require them to practice many literacy skills, such as reading, writing, listening, speaking, and learning about language, i.e., the English language, to interact with one another across the world.

Given the reach, popularity, and potential of online manga and anime in language learning and literacy education, the author reviewed a limited body of literature to learn from the discussions about and the studies on the use of manga and anime in the field of language learning and literacy education. Specifically, in this conceptual paper the author explains the notion of the universal culture that these two genres represent; the notions of New Literacies Studies and Multimodality in the use of manga and anime in language learning and literacy education; and (more importantly) the potentials and problems that have been identified with their use (or lack thereof) in the field of language and literacy education. Lastly, the author offers views, recommendations, and implications for the use of online manga and anime in the field of language learning and literacy education.

2. Manga and Anime Presenting Universal Culture and Promoting Literacy Practices

What was then a post-war development and served as a form of social entertainment conveying public service messages in Japan, manga and anime are now being marketed locally and internationally throughout the world by Japanese conglomerates as part of Japan's most marketable product (Brienza, 2009). Slowly stemming from the shades of post-war themes, manga and anime grew more and more into various other themes portraying the Japanese and universal culture. The works of manga and anime became increasingly understood as a cultural flow from Japan to Asian countries, as well as to North American and European countries (Bryce et al, 2008). Because manga and anime mainly derive from Japan, they are quite distinct in features. For example, the manga and anime are usually drawn with flamboyant and unrealistic characteristics (i.e., extremely big eyes; slim and slender legs; colorful hair and extreme hair styles; and stylized costumes and appearances). Conversely, many manga and anime also have the portraits or animations of its characters somewhat simplistic, especially with regards to the facial expressions of their characters. However, regardless of the flamboyance or the simplicity of the drawings of the characters, the characters in manga and anime represent a complex array of physical and emotional states (Adams, 2001). Due to this fact, manga and anime interest both male and female audiences of all ages (including school children) from all over the world—and as such, they have become a worldwide cultural phenomenon (Drazen, 2002).

The notion of manga and anime as an international culture lies in the processes of translating, transcribing, subbing, dubbing, and redistributing the manga and anime, which are done by the fans of these genres for international audience. In doing so, these fans learn about both the Japanese culture and the English language (i.e., the language that online manga and anime consumers throughout the world interact most with). More importantly, they also engage in many language learning and literacy practices, such as reading about, commenting on, and editing/reviewing other fans' insights on their favorite manga and anime (Black, 2009). From the view of language learning and literacy education these consumptions and (re)distributions of manga and anime genres (i.e., translating, transcribing, subbing, dubbing and redistributing the manga and anime) relied heavily on literacy practices and language competencies. Through the online medium, these fans—including English language learners—display their existing knowledge and linguistic competencies, such as writing poignant arguments, making critical reviews, reading and revising fan works, and many other literate practices. Through these linguistic activities, and other literate practices, such as creating and maintaining online fan sites and engaging in other online social networking activities (e.g., online discussion boards, forums, chat rooms, events, etc.), they also managed to “receive input from and/or interact with youths from across the globe, as they develop new linguistic and technical skills” (Black, 2009, p. 399).

3. New Literacies Studies and Multimodality

When talking about online popular culture and the use of technology in the language/literacy education field, the theories that are often associated with them are the notions of “New Literacy Studies” and “Multimodality.” The theory of New Literacies Studies posits to the need to broaden our understanding of literacy, in which it views the multitude of literacies as a range of social practices affected by social factors, such as socioeconomic status, race, or gender, and linked to broader social goals (Schwartz & Rubinstein-Avila, 2006). The studies on new literacies or multi-literacies focus on “a new stance that recognizes literate practices as dependent on the integration of visual (including both print and image), performed, oral/aural, and embodied forms of representation” (Moje, 2009, p. 352). Scholars and educators agree that online popular cultures, such as online manga and anime, fit into this notion of New Literacies Studies.

Meanwhile the notion of Multimodality refers to the use of “image plus language in increasingly complex ways” (Brown, 2006). The notion of multimodality also fits perfectly in the study of manga and anime in language learning and literacy education. The reason for this argument is that the manga readers and anime viewers, especially those who read and watch them online, are likely to attend to more graphical information on the computer screen as opposed to on the printed text. This is a drastic change from traditional reading that involves attending first to the written text, using pictures and

illustrations only as supplements to it (Schwartz & Rubinstein-Avila, 2006). Online manga and anime consumers are said to require “a complex visual reading on the part of the reader” (Adams, 1999, p. 71) especially if they are reading/watching online manga and anime—where there are multi-mode of medias are being projected onto the screen (i.e., texts, graphics, sounds, and animations).

Scholars of manga and anime in language learning and literacy education agree that online popular cultures, such as online manga and anime, fit into this notion of New Literacies Studies and with the idea of multimodality. Online manga and anime is different than other forms of popular culture is because these genres are the embodiment of hybrid texts. This is because manga readers and anime viewers, especially those who read and watch them online, are likely to attend to social and graphical information at the same hierarchical level as the printed text. These skills manga readers and anime viewers’ use may transfer well to other media, and vice versa (Schwartz & Rubinstein-Avila, 2006). More importantly it may also transfer to other purposes of reading/watching manga and anime—such as developing language/literacy competencies—instead of for mere entertainment purposes.

4. Manga and Anime in Language Learning and Literacy Education: The Potentials

A number of academic discussions about and studies on the use of online manga and anime have been done in the field of language learning and literacy education. Albeit little in number these academic papers report highly positive remarks for the use of manga and anime in language learning and literacy education.

The depth of issues and themes within manga and anime is also one of the virtues that researchers find in language learning and literacy education, especially in teaching and learning English literature. Seyfried (2008) contends that manga and anime need to be used in middle and high school because students (at this age) are ready to engage with intense emotions. The popular success of manga and anime works that delve into weightier human themes have proven as robust text genres, capable of faithfully representing a wide variety of material (Galman, 2009). One feature of the manga and anime that make them suitable for the teaching and learning of literacy, such as the English language (as the first or second language), is that these genres often allow for pages to be read and scenes to be viewed in a variety of ways, leaving them open to variable interpretations and multiple meanings within the overall narrative (Adams, 2001). Graphic novels, such as manga, have been found to be very effective in the teaching of English literature. In his study on the use of graphic novels by students, Seyfried (2008) found that by using graphic novels students are introduced to complicated philosophical concepts. With manga and graphic novels’ tone being quite distinct from prose fiction, the scope for telling stories of greater complexity and depth is increased (Seyfried, 2008). The students, as Seyfried (2008) observed, managed to identify and respond to the poignancy of the stories immediately where the characters, the themes, and the conclusions made sense.

In this regard, the manga and anime genres, as argued by Galman (2009), can be a unique, highly flexible tool for the examination, understanding and representation of cultural phenomena. Bryce and colleagues (2008) agree to this notion, where they believe the appreciation of manga and anime is highly interactive, involving high literate activities, such as meaning-making ‘off the page’ by circulating as part of social identities, practices, and exchanges generative of fan-based communities. Also, the manga and anime address themes, such as politics, daily life, and autobiography in creative (often sober) composition and style (Galman, 2009). In doing so, the manga and anime capture the multiplicity of voices and the historically- and socially-situated nature of stories by making use of “systems of symbols, texts, and images that allow multiple interpretations to occur simultaneously” (Galman, 2009, p. 200).

Manga and anime can also prove to be quite the motivating factor for students in language learning and literacy education. Seyfried (2008) argues graphic novels (i.e., manga) are more than just an elective or a book group. Manga seem to increase students’ confidence as readers and to develop their enjoyment of reading. Instead of heralding a regression from the art of the written word, studies are finding that manga and graphic novels are providing a new bridge to it (Black, 2009; Moje, 2009). Moreover, as the manga are usually a single tale told over a series of volumes, this encourages a commitment on the part of the reader to spend the time and effort to read a longer tale (Poitras, 2008). In another instance, Adams (2001), in his study on the use of manga among high school students, reports that the students reading skills are influenced and heightened due to reading manga.

Schwartz and Rubinstein-Avila (2006) also believe that manga and anime as a popular culture can serve as a tool for literacy development and critical inquiry, which is a very important skill in reading. The characteristics of manga and anime require multimodal reading skills and sharp critical inquiries. Hence, by using online manga and anime in a literacy classroom, students would be able to use the mechanics and multimodalities of these genres to learn “how to question their own pleasures” (Schwartz & Rubinstein-Avila, 2006, p. 47). Furthermore, manga and anime storylines not only afford readers a non-linear, rich imaginative read of the world, but also tap into an array of complexities in human experiences toward which young adults seem to feel great affinity (Schwartz & Rubinstein-Avila, 2006). They also argued that in order to incorporate the manga and anime into the literacy classroom, teachers need to be critical educators who can encourage youths’ reflexivity about their use of popular culture by selecting appropriate texts for the classroom to help students situate themselves in the world around them and underscore how power shapes the students’ “emotional, political, social, and material lives” (Schwartz & Rubinstein-Avila, 2006, p. 47).

Another aspect of manga and anime that is highly applauded by English education researchers is in terms of their use among learners of English as a second language (ESL). This is especially for international students (or even immigrant and refugee students) who are learning in English speaking countries, such as the United States of America, Canada, and the United Kingdom, among many others. An important aspect in the consumption (i.e., reading and watching) of manga and anime contributing to their potential in teaching and learning of the English as a second language (ESL) is the translation of the Japanese manga and anime to the English-dubbed, English-subbed, or English-translated versions of the manga and anime disseminated in the online sphere for its larger universal audience. Black (2006) reports that due to the limited availability of English-language translations of Japanese texts, fans regularly produce their own translations of manga, by scanning them, overlaying English text, and then sharing them on the Web, as well as sharing their own English voice-dubbed versions of anime. The act of subbing, dubbing, or scanning the original manga and anime for redistribution is “an essential part of manga and anime fandom outside of Japan, not only because they provide new material for audiences, but because they are usually shared on websites with highly interactive virtual forums for fans” (Bryce et al., 2008). The act of subbing, dubbing, or translating the manga and anime enables and enhances meaning-making, in that fans, as translators, are in control of the meaning of the texts, and produce this meaning for the enjoyment of other fans.

In this sense, the use of online manga and anime in language learning and literacy education allows participants to create a performance “complete with pen-and-ink actors, sets, scripts, dialogue and the like to make a drama of their words” (Galman, 2009, p. 213) in that they would be allowed to explore (i.e., read) and produce (i.e., write) manga and anime interpretations of their own. Through intimate involvement with these texts, the fans engage in highly literate practices and language learning (such as, learning new vocabularies, reading critically, writing types of prose, and so on) as they re-form and re-generate these texts for others fans to create a deep attachment and build a sense of authorship over them (Bryce et al., 2008). Black (2009) supports this notion as she reports that reading/watching online manga and anime, and later producing their own manga/anime afford the students to index transcultural facets of their identities and develop meaningful cross-border relationships online. The students in her study also gained confidence and competence in a wide range of literate activities (such as reading, writing, revising, editing, etc.) and forms of representation, and the activities afforded them a “great deal of creative agency as they took up, reconstituted, and then redistributed cultural, linguistic, symbolic, and ideological material to a broad audience” (Black, 2009, p. 402).

Black (2009) also argues that the consumption and production of online manga and anime can provide a sense of relativity for foreign or international students in English-speaking countries in the way in which “technology-mediated, out-of-school literacy practices provide a counterbalance for ELL youth’s less successful attempts at using English in academic settings by allowing them to leverage a diversity of resources, including their Asian backgrounds, as they developed identities as powerful language users” (p. 420). Seyfried (2008) reiterates this notion by arguing that via manga and anime students could learn to deeply question how cultures are shown and seen, which is an important aspect of visual literacy, where they can serve to challenge readers’ observational skills while at the same time inform them. In this regard, manga and anime are also known to offer the language learning and literacy education classroom lessons on representation and identities. Schwartz and Rubinstein-Avila (2006) believes the manga and anime genres can act as entry points for critically examining societal disparities in the representation of gender and sexuality. Although manga and anime is by origin Japanese genre,

inequalities in the representation of males and females persist cross-culturally, and such issue is very important for young adult students in middle or high schools to learn about. Manga and anime can also provide a way for youths to negotiate alternative identities. By engaging with a wide range of manga and anime characters, dynamic plots, and storyboards, children and young adults make connections between these popular texts and their own life experiences (Schwartz & Rubinstein-Avila, 2006).

5. Manga and Anime in Language Learning and Literacy Education: The Problems

Even with the positive reports on the use of manga and anime in the field of language learning and literacy education, there are still concerns with the use of these genres in education. Given the popularity of online manga and anime among young adults, and their worldwide reach through the medium of the Internet, these genres have neither been explored in greater depth in the literacy research literature nor used widely in the classroom setting. So far, discussions regarding manga and anime are dominated by scholars in the field of cultural studies (Schwartz & Rubinstein-Avila, 2006). The academic establishment has yet to fully recognize these genres as legitimate formats for academic discourse. Galman (2009) argues that teachers and parents often undermine the ability to make meaning from the myriad of online popular culture texts to which young people are exposed. Online manga and anime, along with online comics and online games, are often perceived as contributing to students' short attention spans, passivity, and lack of creativity, and as providing distractions from educational practices (Schwartz & Rubinstein-Avila, 2006). Hence, the discussions about and reports on use of manga and anime in the field of education is terribly scarce.

However, and more importantly, the little amount of studies on manga and anime that are readily available in the education field are not conclusive to the impacts and effects of online manga and anime in language learning and literacy education. Moje (2009) believes that the "research that exists on digital text use and its effect on achievement (as measured in tests and grades) is not extensive, and what does exist is inconclusive" (p. 357). Due to this inconclusiveness, Moist and Bartholomew (2007) calls for a nuanced and open critical approach that can deal with multiple perspectives and that builds connections between and among the positive and negative views of the use of manga and anime in language learning. There needs to be more research on manga and anime within the field of education. In this sense, Brown argues that studies on online popular culture, such as manga and anime, must not rely from other disciplines—but also contribute to them. Moje (2009) reiterates this notion by reporting that researchers need to conduct studies looking at new media literacies phenomena similar to those of other studies, with different groups, and then compare across studies (and academic fields) to generate richer and more complete theoretical insights.

Researchers need to maintain close and particular study at the "forefront of research in new media and literacies because the field shifts and changes rapidly" (Moje, 2009, p. 355). Moje (2009) believes that close and precise analyses must continue because there is still so much to learn about existing new media (such as the manga and anime), their uses, and their consequent literacy practices. In addition, Moje (2009) also strongly argues for researchers to study issues of access of new media and online popular culture in more depth because these studies can offer "comparative work across youth of different social class groups as a way of representing more fully the range and intensity of practices" (p. 356). From her analyses of studies done on new media, Moje (2009) contends that there are studies done on different age groups with different interests and experiences in new media, and how they engage in new media practices differently. However, she believes there needs to be "more attention to the range of practices of different groups might engage and to documenting practices across groups... taking into account findings across local and particular studies" (Moje, 2009, p. 356). In all, manga and anime studies need to include investigation of how these genres, through institutional recognition and incorporation as mass produced commodities, are granted wider social and cultural legitimacy and agency (Bryce et al., 2008).

6. Conclusion

The fact to the matter is manga and anime are very universal and they are very popular among young adults, children and even adults. More importantly, access to them can easily be sought through

the medium of the Internet, in which a lot of language learning and literate practices are taking place. All of the literacy elements one finds in manga and anime can draw readers of different ages and interests to a large number of works (Poitras, 2008). The use of manga and anime in language learning and literacy education is also very positively reviewed by literacy education scholars. Albeit small in number, a number of research have reported the success of using manga and anime in education for various purposes and for various intentions, such as, in teaching and learning of English literature, critical reading skills, creative writing skills, and so on. Some educators are also making use of manga and anime to develop students' traditional writing skills; to encourage urban high school students' development of reading and written communication skills; to narrate their own individual stories in a written composition; to instruct students on how to effectively convey multiple ideas in fewer words; and to develop students' analytical and critical reading of visual texts (Schwartz & Rubinstein-Avila, 2006). And thus, these forms of online popular culture is not (and should not be) something foreign. As such, more progressive steps need to be taken by scholars, teachers, and educational institutions to acknowledge manga and anime in the world of education.

Due to the reach and access of the Internet, these genres have gained worldwide recognition due to their massive audience and their distribution in the world. The fans of manga and anime are far and wide and they range from various backgrounds, be it in terms of language, culture, age, or gender. Quite a number of studies have suggested positive educational outcomes from the use of manga and anime in English education. Yet, at the same time, these studies are still not enough to inform the scholars, teachers, and educational institutions of their true potentials and how they can actually be implemented in classroom settings. More studies need to be done to carefully learn about the use of online manga and anime in language learning and literacy education. In all, online manga and anime are here to stay, and the demand for manga and anime genres never decreased ever since the 1960s. Teachers, researchers and educational institutions need to not only recognize the appeals, potentials, and benefits of manga and anime—and take this opportunity to use employ manga and anime in language learning and literacy education—they also need to learn about the negative outcomes or possible issues that these genres have that can (and has thus far) hinder its use in language learning and literacy education. Therefore, we need to study these genres more closely, and discuss about the more openly, so that we would be more informed of them and that we can benefit more from them in language learning and literacy education.

References

- Adams, J. (2001). A Critical Study of Comics. *Jade* 20.2, *NSEAD* 2001, 133-143.
- Black, R. W. (2005). Access and affiliation: The literacy and composition practices of English-language learners in an on-line fanfiction community. *Journal of Adolescent & Adult Literacy*, 49 (2), 118-128.
- Black, R. W. (2006). Language, culture, and identity in online fanfiction. *E-Learning*, 3 (2), 170-184.
- Black, R. W. (2007). Fan Fiction writing and the construction of space. *E-Learning*, 4 (4), pp. 384-397.
- Black, R. W. (2009). Online fan fiction, global identities, and imagination. *Research in the Teaching of English*, 43 (4), May 2009, 348-425.
- Brienza, C. E. (2009). *Books, Not Comics: Publishing Fields, Globalization, and Japanese Manga in the United States*. Springer Science+Business Media, LLC 2009.
- Brown, S. T. (2006). *Cinema Anime: Critical Engagement with Japanese Animation*. New York: Macmillan.
- Bryce, M., Davis, J. & Barber, C. (2009). *The Cultural Biographies and Social Lives of Manga: Lessons from the Mangaverse*. Retrieved on July 17th, 2009, from http://scan.net.au/scan/journal/display.php?journal_id=114
- Drazen, P. (2002). *Anime Explosion! The What? Why? & Wow! of Japanese Animation*. Berkeley, CA: Stone Bridge Press.
- Moist, K. M. & Bartholomew, M. (2007). *When Pigs Fly: Anime, Auteursim, and Miyazaki's Porco Rosso*, London, Los Angeles, New Delhi & Singapore: SAGE Publications.
- Moje, E. B. (2009). Standpoints: A call for new research on new and multi-literacies. *Research in the Teaching of English*, 43 (4), May 2009, 348-361.
- Poitras, G. (2008). What is manga? *Knowledge Quest Visual Literacy*, 36 (3), 44-48.
- Schwartz, A. & Rubinstein-Avila, E. (2006). Understanding the manga hype: Uncovering the multimodality of comic book literacy. *Journal of Adolescent and Adult Literacy*, 50 (1), 40-51.
- Seyfried, J. (2008). Reinventing the book club: Graphic novels as educational heavyweights. *Knowledge Quest Visual Literacy*, 36 (3), 44-48.

Online Popular Culture in Language Learning: Reading and Writing Online Fanfiction

Abu Bakar RAZALI (PhD)

Faculty of Educational Studies, Universiti Putra Malaysia (UPM), Malaysia

mr_bakar@upm.edu.my

Abstract: With the reach and accessibility that technology has provided, in particular the Internet, language learning has taken a different height. With the reach of the Internet worldwide, it is now very important to learn an international language, such as the English language, which the language most widely used in the Internet realm. Also, with the immense consumption and distribution of popular culture within the Internet, the concept of learning has evolved and given new meanings. One particular field that education researchers consider as a platform in language learning is the reading and writing of online fanfiction. This literature review examines a small number of research done so far on online fanfiction and its effects on learning the English language. In this review of studies of online fanfiction in language learning, the author discusses the participants of online fanfiction and the types of participation they engage in when reading or writing online fanfiction that thus lead to them learning about the English language.

Keywords: English language learners (ELL), English as a second language (ESL), language acquisition, language learning, online fanfiction.

1. Introduction

Fanfiction is fiction about characters or settings written by fans of the original work, rather than the original creators. It is the act of taking a story created by someone in the form of a book, television program or movie, and using it as a jumping-off point for new fiction within that world or across it. It is a channel for creative writing within a setting already defined by someone else; it is a way to share ideas with other fans, and means to explore facets of popular characters, themes, settings and plots (Black, 2005). The origins of fanfiction can be traced back to the 1930s pulp magazine *Fanzines*, and it enjoyed a surge in the late 1960s with the popularity of *Star Trek* (Thomas, 2006a). However, it is only in the 1990s that fanfiction was widely practiced by fans of television series, books, movies, and comic books. This was due to the surge of the Internet and the accessibility it offers to the fanfiction communities. Since then, online fanfiction has flourished and burst through the online scene especially with young adults and adolescents (Thomas, 2006b). In this sense, online fanfiction is “an element of popular culture that is ever growing in popularity as new technologies enable native and non-native English speaking fans from all over the globe to meet online to share, critique, and build upon each other’s fictions” (Black, 2005).

Online fanfiction has attracted quite a number of researchers in the fields of communication, arts, culture, and currently in the field of language learning. The reason that education researchers are interested in studying online fanfiction varies. Some researchers believe that online fanfiction is able to enhance and extend students’ literacy practices, such as reading and writing creatively and critically (Black, 2004, cited in Steinkuehler et al, 2005). Studying the writing of online fanfiction also allows researchers to learn how learning is accomplished in a participatory culture in which young people collectively pool their resources, i.e., sharing knowledge and getting latest information on their favourite stories (Alvermann, 2008). Through the study of students’ writing of online fanfiction, some researchers believe teachers will have a better understanding about student identity and self-representation. This is as because people who portray themselves in the virtual world as being someone other than the person that people in the real world perceive them to be, may have stories to tell that teachers, teacher educators, and researchers have not been privy to in the past (Alvermann, 2008).

The goal of this literature review is to examine the small number of studies done so far on online fanfiction in language learning. In particular, the review of the literature sought to answer these questions:

(1) Who are the people participating in reading and writing online fanfiction?; (2) How do they participate in reading and writing online fanfiction?; and (3) Is there any evidence on how reading and writing online fanfiction can enhance language learning? Through this literature review, the author also hopes that it would shed more light on the directions for research of online fanfiction in language learning.

2. Reviewing the Literature

This literature review reports on studies on the use of online fanfiction specifically in language learning (i.e., English language). Several major online research databases were researched in obtaining these studies (i.e., JSTOR, ProQuest, ScienceWiley, and SAGE). A few studies were also obtained from the Google Scholar search engine. The searches in all of these online databases were confined to the use of specific terms, such as “online fanfiction studies” or “reading and writing online fanfiction.” To explain, there were 743 studies found with the term “online fanfiction studies,” and 706 studies found in the electronic databases using the term “reading and writing online fanfiction.”

With the majority of these articles found in the Internet resources being commentaries, reviews, and essays on the use of online fanfiction, stringent selection of only empirical studies was done. Certain selection criteria were met to ensure that the studies were focused on the use of online fanfiction in language learning. First, the literature review focuses on only articles from peer-reviewed journals, such as *Journal of Adolescent & Adult Literacy*, *E-Learning Journal*, *The Journal of American Culture*, *English in Education*, *The Reading Matrix*, *Australian Journal of Language and Literacy*, *Annual Review of Applied Linguistics*, *Educational Philosophy and Theory*, and also e-books and periodicals, namely *The International Handbook of Virtual Learning Environments* and *A New Literacies Sampler*. Other studies done outside of this scope, that might employ different methods of research, different samples, and different types of online fanfiction activities were not reported. Second, the studies in this literature review were selected under the notions of language learning. Other studies that were done on writing online fanfiction, but within umbrellas of other fields, such as computer studies or communication studies were not included. Studies that suggested similar genres (i.e., fandom, fantasy writing), but did not use the terms mentioned previously, were excluded from the review. These steps were taken to minimize the review of irrelevant studies which might not be suitable for this literature review.

As many as 15 studies on the use of online fanfiction in learning the English language were found. All of the 15 studies on online fanfiction and language learning discuss about language education for both native and non-native speakers of the English language. They were published between the years 2002 to 2010. It must be noted that because of the nature of online fanfiction, the studies chosen tended to be more of the qualitative nature rather than quantitative. Fourteen of the studies applied qualitative research method. From these 14 studies, four are case studies; seven studies applied analysis of written discourse of the written response from the fanfiction writers and readers through the studies; and two studies are ethnographic studies. Only one study was conducted using a quantitative method, which is by using an online survey. All of the studies were done in the United States of America, except for one, which was conducted in Finland (Stepanova, 2007). All studies chosen were written in English language, regardless of whether they were written and published outside of English speaking countries.

3. Results and Findings

This literature review is presented in two main aspects, namely a) Participants in Online Fanfiction and Participation in Online Fanfiction. The reason this literature review is divided into these two parts is to show the participants in online fanfiction, (i.e., which range from children to young adults—most of which are within school-age limit) and to show the types of literacy practices (i.e., reading and writing activities) that they engage in the English language, that thus promote language learning for these online fanfiction enthusiasts, either formally or informally.

3.1.1 Participants: Readers and Writers of Online Fanfiction

Number of Participants. The numbers of participants vary across studies due to the research designs and methods that the researchers use in studying them. There are nine studies (60%) that had fewer than ten participants (i.e., Black, 2005; Black, 2006; Chandler-Olcott & Mahar, 2003; Herzing, 2007; Mackey & MacCaly, 2008; Thomas, 2006a; and Thomas, 2006b). These studies are mainly case studies (i.e., Black, 2006; Chandler-Olcott & Mahar, 2003; Thomas, 2006a; and Thomas, 2006b), studies that used analyses of written discourse (i.e., Kustritz, 2003; Mackey & MacCaly, 2008; Mazar, 2006), and an ethnographic study (i.e., Black, 2005). There is one study that had below ten participants and used a mixed-method design of case studies and analysis of written texts (i.e., Herzing, 2005). From the nine studies, three studies had only one participant (i.e., Black, 2005; Black, 2006; Mackey & MacCaly, 2008), three studies had two participants (i.e., Chandler-Olcott & Mahar, 2003; Thomas, 2006a; and Thomas, 2006b), one study had three participants (i.e., Herzing, 2005), one study had six participants (i.e., Kustritz, 2003), and lastly one study had ten participants (i.e., Mazar, 2006). There are three studies (20%) that had more than ten participants (i.e., Allington, 2007; Bury, 2006; Kem, 2005). Two of these studies use analysis of written discourse (i.e., Allington, 2007; Bury, 2006) and the other one used an online survey (i.e., Kem, 2005). Allington (2007) has eleven participants, Bury (2006) has 22 participants, and Kem (2005) has 143 respondents to her online survey. There are three studies (20%) that did not mention the number of their participants (i.e., Black, 2007; Blasingame, 2002; Stepanova, 2007).

Age Level. The age levels of participants in the selected studies vary across studies as well. From the fifteen studies selected, there are six studies (40%) that had young adults as their participants (i.e., Black, 2005; Black, 2006; Thomas, 2006a; Thomas, 2006b; Allington, 2007; Stepanova, 2007). In contrast, there are only four studies (26.7%) that had adults as their participants (i.e., Chandler-Olcott & Mahar, 2003; Herzing, 2005; Kem, 2005; Bury, 2006). Unfortunately, there are five studies (33.3%) that failed to mention the specific age level of their participants (i.e., Blasingame, 2002; Kustritz, 2003; Mazar, 2006; Black, 2007; Mackey & MacClay, 2008). The appeal of the online fanfiction to the younger generation may have contributed to the number of the participants in the studies to be more likely of young adults. However, it is a nice surprise to find that one study reported a senior online fanfiction writer, which is the study by Herzing (2007) in which the author had three participants from three different age levels (i.e., an 11-year old girl, a 70-year old professor, and a 19-year old college student). From this review of studies, it can be reported that majority of the studies focused on young adults and children, i.e., those in school-age range.

Nationalities of Participants. From the selected fifteen studies, there are twelve studies (80%) that had participants from the United States of America (i.e., Blasingame, 2002; Chandler-Olcott & Mahar, 2003; Kustritz, 2003; Herzing, 2005; Kem, 2005; Bury, 2006; Mazar, 2006; Thomas, 2006a; Thomas, 2006b; Allington, 2007; Mackey & MacClay, 2008). Meanwhile, there are only two studies (13.3%) that had Asian participants, and only one study (6.7%) that had European participants, because it was conducted in Europe (i.e., Finland). Interestingly, the studies that had two Asian participants were also done in the United States of America, and the participants are actually immigrants from China who are studying in the United States, and they do not speak English as the first language. In this regard, majority of these studies was done to study native speakers' use of online fanfiction in language learning, but, there are also studies that focused on the use of online fanfiction for non-native speakers in learning the English language.

3.1.2 *Participation: Reading and Writing Online Fanfiction*

Online Fanfiction Web Domains. The web domains that the participants use in reading, writing, or publishing their fanfiction works are almost equal in terms of public and private web domains. From the fifteen studies selected, seven studies (46.7%) reported on participants who publish their works on public fanfiction sites (i.e., Black, 2005; Black, 2006; Mazar, 2006; Thomas, 2006a; Thomas, 2006b; Black, 2007; Mackey & MacClay, 2008). Meanwhile, eight studies (53.3%) were done on participants who post their works in private group domains (i.e., Blasingame, 2002; Chandler-Olcott & Mahar, 2003; Kustritz, 2003; Herzing, 2005; Kem, 2005; Bury, 2006; Allington, 2007; Stepanova, 2007). The public fanfiction sites might allow participants to share or publish their works to more and different plethora of fanfiction enthusiasts, while the specific online fanfiction group sites allows only the members of those designated sites. Thus, both of these domains might have different appeals to researchers and online fanfiction readers/writers alike.

Purposes for Online Fanfiction Participation. All of the studies (100%) selected participants who are already engaged or involved with fanfiction prior to the studies. It is also reported that the participants in all of the studies are involved in the fanfiction as a leisure activity and not as a required activity from the schools, parents, or even the researchers themselves (i.e., Allington, 2007; Black, 2005; Black, 2006; Black, 2007; Blasingame, 2002; Bury, 2006; Chandler-Olcott & Mahar, 2003; Herzing, 2005; Kem, 2005; Kustritz, 2003; Mackey & MacClay, 2008; Mazar, 2006; Thomas, 2006a; Thomas, 2006b; Stepanova, 2007). In this regard, it is quite interesting to learn that these participants engaged in online fanfiction voluntarily (i.e., without being instructed by teachers), and more importantly because they are engaging in the many language learning activities in reading or writing online fanfiction on their own, such as reading critically, giving feedback, and writing creatively and analytically, among others.

Online Fanfiction Genres. The genres that fanfiction writers read and write vary across the studies. In five out of fifteen studies (33.3%), the participants read and write their fanfiction works based on Television series (i.e., Blasingame, 2002; Bury, 2006; Herzing, 2005; Kem, 2005; Mazar, 2006). In four studies (26.7%) the participants read and write fanfiction works based on 'anime' or Japanese animation (i.e., Black, 2005; Black, 2006; Black, 2007; Chandler-Olcott & Mahar, 2003). An equal number of the participants (26.7%) also read and write works based on books and novels (i.e., Allington, 2007; Stepanova, 2007; Thomas, 2006a; Thomas, 2006b). Two studies (13.3%) reported their participants used movies as the genre basis for their fanfiction activities (i.e., Kustritz, 2003; Mackey & MacClay, 2008). From the review, it is interesting to see that the participants in these studies chose a quite a range of online fanfiction genres to engage in (i.e., read, write, and publish). This implies that reading and writing online fanfiction vary across genres and appeal to many people with many different interests.

Online Fanfiction Themes. From the review of these studies, most of the participants focused on reading and writing online fanfiction based on the theme of science fiction. To illustrate, there are seven studies (46.7%) that reported participants' reading and writing online fanfiction based on the theme of science fiction (i.e., Black, 2006; Black, 2007; Herzing, 2005; Kem, 2005; Mazar, 2006; Stepanova, 2007; Thomas, 2006a). Meanwhile, there are three studies (20%) that focused on the theme of action adventure (i.e., Blasingame, 2002; Chandler-Olcott & Mahar, 2003; Mackey & MacClay, 2008). Three studies (20%) focused on the theme of eroticism (i.e., Allington, 2007; Bury, 2006; Kustritz, 2003); and two other studies (13.3%) focused on the theme of romance (i.e., Black, 2005; Thomas, 2006b). It can be posited that due to the nature of fanfiction (i.e., to re-create stories or characters from the original stories) the theme of science fiction seem best suit with what most of the studies focus on and the students' interest—especially those who are in the school-age level. The theme of science fiction is also very appealing to these participants due to the creative space that the online fanfiction can afford to its enthusiasts in terms of reading, writing, and discussing about their favorite science fiction-themed stories.

Intended Audience. The majority of studies reported that the participants' online fanfiction works is published for public viewing. Eight studies (53.3%) used public domains and the participants in these studies published their work for public viewing (i.e., Black, 2005; Black, 2006; Black, 2007; Mackey & MacClay, 2008; Mazar, 2006; Thomas, 2006a; Thomas, 2006b; Stepanova, 2007). Five studies (33.3%) focused on fanfiction on specific online societies that the participants intend to share works with (i.e., Blasingame, 2002; Bury, 2006; Herzing, 2005; Kem, 2005; Kustritz, 2003). Only two studies (13.3%) reported that the participants' works of fanfiction are intended for close friends and peers that they virtually know (i.e., Allington, 2007; Chandler-Olcott & Mahar, 2003). The fact that majority of participants publicly publish their fanfiction works shows that these students are practicing very important literate practices that thus lead to language learning. To illustrate, these literate practices include thinking about the quality of their writing (such as grammar, sentence structures, etc.) as well as their literature knowledge (such as development of characters and plots, themes, and settings, etc.). They publishing their works publicly also indicate that they allow their peers to read and give them feedback on their works—in which both parties practice critical thinking and communication skills.

Frequency of Reading and Writing Online Fanfiction. Seven studies (46.7%) reported that participants read and write online fanfiction on daily bases (i.e., Black, 2007; Kem, 2005; Kustritz, 2003; Mazar, 2006; Stepanova, 2007; Thomas, 2006a; Thomas, 2006b). Meanwhile, five studies (33.3%) reported participants' engagement with online fanfiction in various times (i.e., Black, 2005; Black, 2006; Bury, 2006; Blasingame, 2002; Herzing, 2005). Only one study (6.7%) focused on a weekly basis publishing of work (Mackey & MacClay, 2008). And, there are two studies (13.3 %) that did not mention of the frequency of rading and writing of the participants in their studies (i.e., Allington, 2007; Chandler-Olcott & Mahar, 2003). Even though many studies report varied time spent on the online

fanfiction sites, it is understandable with the nature of the Internet and online fanfiction being accessible and available within the readers and writers' own convenience. In this regard, the readers and writers of online fanfiction are motivated to read and write works of fanfiction in their own pace.

Language in Reading and Writing Online Fanfiction. All of the reading materials and writings produced by all of the participants were in the English language. However, there are twelve studies (80%) that reported on participants using only the English language as the medium of writing (i.e., Allington, 2007; Black, 2007; Blasingame, 2002; Chandler-Olcott, 2003; Herzing, 2005; Mahar, 2003; Kem, 2005; Kustritz, 2003; Mackey & MacClay, 2008; Mazar, 2006; Thomas, 2006a; Thomas, 2006b; Stepanova, 2007); whereas there are three studies (20%) that focused on participants' use of 'hybrid language,' or the use of English language with particular Japanese or Chinese words. These participants used hybrid language in order to show authenticity of the works they are based upon. These hybrid language are derivative from the genre of the writing itself, such as Japanese Anime (i.e., Black, 2005; Black, 2006; Bury, 2006). Three of the studies that focus on the use of hybrid language (i.e., Black, 2005; Black, 2006; Bury, 2006) specify that the reason for their choice was due to nature of the participants being English language learners (ELL). However, and more importantly, due to the fact that most of the participants are school-age children and that they are learning English as either the first or second language, it is reported that they are engaging in many language learning elements when they read and write online fanfiction. These language learning elements are not limited to them only reading and writing works of fanfiction, but also discussing about their works in details (i.e., in chat forums)—in which this promotes communication skills—and they also engage in higher order thinking skills to which they analyse and give feedback on each other's fanfiction works.

4. Discussion and Conclusion

From the studies reviewed, it is learned that online fanfiction has positive appeal and effect in students' language learning (i.e., Black, 2007; Herzing, 2005; Thomas, 2006a; Thomas, 2006b). From these studies of the use of online fanfiction, researchers managed to investigate participants' reading preferences, reading skills, writing skills, communication skills, and textual culture (i.e., Allington, 2007; Blasingame, 2002; Kustritz, 2003; Mazar, 2006). These studies also managed to provide evidence to the development of the literary skills and social practices in online fanfiction, such as English communication skills through chat forums and giving/receiving feedback on fanfiction works (i.e., Black, 2005; Black, 2006, Black, 2007; Bury, 2006; Chandler-Olcott & Mahar, 2003). In this sense, the researchers managed to find evidences of learning the English language taking place in online fanfiction where they managed to see the feedback and response of peers and audience of the online fanfiction and understanding of readers and author co-design the writing/reading space—all of which were done in the English language between native and non-native speakers of English (Black, 2005). Language development within the consumers of online fanfiction is also evident where studies found that fanfiction readers and writers develop codes and conventions to govern themselves (Mackey & MacClay, 2008) especially in the interrelations between fanfiction and its canonical source (Stepanova, 2007). Moreover, it is found that online fanfiction can enhance and extend students' literacy practices (Steinkuehler et al., 2005); create participatory cultures where writers may pool resources—learn about the English language and culture (Alvermann, 2008); and also give teachers better evidence about student identity and self-representation, especially for international students who are learning English as a second language in English-speaking countries (Alvermann, 2008).

Albeit small in number, all 15 studies in this literature review espouse great support for online fanfiction, especially to the fact that online fanfiction can enhance students' literacy practices and language learning skills. In all, online fanfiction has attracted many scholars and researchers to study it and its societies. However, as evident with only 15 studies that had been found so far in the language learning field, the focus on online fanfiction as a tool for language learning is still considered in its infant stage. Most of the studies reviewed have concentrated on small-scale level of its use in earning the English language as first or second language and language acquisition. Also, most of these studies have found great values in the use of online fanfiction in language learning—but have not really mentioned some of its possible limitations. Therefore it is worthwhile to see studies done in a larger, deeper, and more globalized (i.e., international) scale to see the possible successes or limitations of reading and writing online fanfiction in language learning.

References

- Allington, D. (2007). How come most people don't see it. *Social Semiotics*, 17 (1), pp. 17-32.
- Alvermann, D. E. (2008). Why bother theorizing adolescents' online literacies for classroom practice and research? *Journal of Adolescent & Adult Literacy* 52(1), pp. 8-19.
- Black, R. W. (2005). Access and affiliation: The literacy and composition practices of English-language learners in an on-line fanfiction community. *Journal of Adolescent & Adult Literacy*, 49 (2), pp. 118-128.
- Black, R. W. (2006). Language, culture, and identity in online fanfiction. *E-Learning*, 3 (2) pp. 170-184.
- Black, R. W. (2007). Digital design: English language learners and reader reviews in online fiction. *A New Literacies Sampler*, chap. 6, pp. 126-136.
- Blasingame, K. (2002). "I can't believe I'm saying it twice in the same century. . . but 'Duh . . .'": The evolution of Buffy the Vampire Slayer sub-culture language through the medium of fanfiction. *The Online International Journal of Buffy Studies*, 20 (1), pp. 1-17.
- Bury, R. (2006). A critical eye for the queer text: Reading and writing slash fiction on (the) line. *The International Handbook of Virtual Learning Environments*, chap. 46, pp. 1151-1167.
- Chandler-Olcott, K. & Mahar, D. (2003). Adolescents' anime-inspired "fanfictions": An exploration of multiliteracies. *Journal of Adolescent & Adult Literacy*. 46, 7, pp. 556-566.
- Costello, V. & Moore, B. (2007). Cultural Outlaws: An Examination of Audience Activity and Online Television Fandom. *Television and Media*, 8 (2), May 2007, pp. 124-143.
- Duke, N. K., & Mallette, M.H. (Eds.) (2004). *Literacy research methodologies*. New York: Guildford Press.
- Grindstaff, L. (2008). Culture and Popular Culture: A Case for Sociology. *The Annals of American Academy*, 619, September 2008, pp. 206-222.
- Herzing, M. J. (2005). The Internet world of fanfiction. *Master's of Arts Thesis. Virginia Commonwealth University*.
- Kem, J. F. (2005). Cataloging the whedonverse: Potential roles for librarians in online fan fiction. *A Master's Paper for the M.S. in L.S degree. University of North Carolina*.
- Kustritz, A. (2003). Slashing the romance narrative. *The Journal of American Culture*, 26 (3), pp. 371-385.
- Mackey, M. & MacClay, J.K. (2008). Pirates and poachers: Fanfiction and the conventions of reading and writing. *English in Education*, 42 (2), pp. 131- 147.
- Mazar, R. (2006). Slash fiction/fanfiction. *The International Handbook of Virtual Learning Environments*, chapter 45, pp. 1141-1150.
- Skinner, E. N. & Hagood, M. C. (2008). Developing Literate Identities with English Language Learners through Digital Storytelling. *The Reading Matrix*, 8 (2), September 2008, pp. 12-38.
- Soukup, C. (2006). Hitching a Ride on a Star: Celebrity, Fandom, and Identification on the World Wide Web. *Southern Communication Journal*, 71 (4), December 2006, pp. 319-337
- Steinkuehler, C. A., Black, R. W., & Clinton, K.A. (2005). Researching literacy as tool, place, and way of being. *Reading Research Quarterly*, 40 (1), pp. 95-100.
- Stepanova, H. (2007). Slash Fanfiction and the Canon. *B.A. Major Thesis, Masaryk University*.
- Stenger, J. (2006). The Clothes Make the Fan: Fashion and Online Fandom when Buffy the Vampire Slayer Goes to eBay. *Cinema Journal*, 45 (4), Summer 2006, pp. 26-46.
- Stern, S. R. (2004). Expressions of Identity Online: Prominent Features and Gender Differences in Adolescents' World Wide Web Home Pages. *Journal of Broadcasting and Electronic Media*, 48(2), June 2004, pp. 218-243.
- Tan, K. E. & Richardson, P. W. (2006). Writing Short Messages in English: Out-of-School Practices of Malaysian High School Students. *International Journal of Educational Research*, 45, 2006, pp. 325-340.
- Thomas, A. (2006a). Fanfiction online: Engagement, critical response and affective play through writing. *Australian Journal of Language and Literacy*, 29 (3), pp. 226-239.
- Thomas, A. (2006b). Blurring and breaking through the boundaries of narrative, literacy, and identity in adolescent fan fiction. *A New Literacies Sampler*, chapter 8, pp. 147-175.
- Warsheur, M. & Grimes, D. (2007). Audience, Authorship and Artifact: The Emergent Semiotics of Web 2.0. *Annual Review of Applied Linguistics*, 27 (1), pp. 1-23.
- Weinstein, M. (2007). Slash Writers and Guinea Pigs as Models for a Scientific Literacy. *Educational Philosophy and Theory*, 38 (5) pp. 10-27.

Pedagogical Methods in Web-Based Language Teaching

Rieko HATTORI (SAITO)^{a*}, Masako HAYAKAWA THOR^b, Yoko MIZUFUNE^c, Hiroko INOSE^d, Mario Antonio LOPES CORDERO^e & Alex PRUTH^f

^a*Dalarna University, Sweden*

^b*Dalarna University, Sweden*

^c*Dalarna University, Sweden*

^d*Dalarna University, Sweden*

^e*Dalarna University, Sweden*

^f*Dalarna University, Sweden*

*rsa@du.se

Abstract: This paper presents a research project that is being conducted at Dalarna University in Sweden. The aim is to study the following: 1) The quality of online language education compared with that of campus education, and 2) Advantages and disadvantages of online language education and how the disadvantages might be overcome. The project consists of two parts: pedagogical methods in online language education from the teachers' point of view and from the students' point of view. The first part was conducted in 2012 and various characteristics (benefits and difficulties) of online language education were identified. Flexibility and wider opportunities were general benefits, while lack of physical co-presence, difficulty in having lively debates/discussions, and high dropout rates were among the problems. The second part of the project (being conducted in 2014) aims to investigate how students experience online language learning. The goal is to explore alignments and misalignments between teachers' perspectives and students' perspectives, and to develop methods to enhance the quality of online education.

Keywords: pedagogical methods, synchronous online education, social aspects of online education

1. Introduction

In recent years, there has been an explosion in online education all over the world and Sweden is no exception. Over the past 10 years, the number of students enrolled in online courses has increased dramatically in Sweden. There were almost 80,500 students enrolled in online education in 2009, which is almost four times more than 10 years prior (Högskoleverket 2010, Statistiska Centralbyrån 2012). In this paper, we introduce a research project, "Pedagogical methods in web-based language teaching", which was carried out at Dalarna University to examine the pedagogical implications of the development of online education.

The research project consists of two parts: "Pedagogical methods in web-based language teaching", which took place in the year 2012 and which aimed to identify the various characteristics (benefits and difficulties) of online language teaching from the point of view of teachers; and "Pedagogical methods in web-based language teaching – Students' point of view", which is being conducted in 2014 and which aims to identify the benefits and difficulties of online language learning as perceived by students.

In particular, the research examines the extent to which teachers' and students' perspectives align or misalign, and identifies the possible reasons for divergent views. Based on the findings, the study also aims to identify potential change in pedagogical approaches which utilize technologies and which provide better support for students' learning.

In this paper, we introduce the results of the first phase of the project and give an overview of the second part.

2. Background

2.1 Online education in Sweden

The number of students studying online at Swedish universities has risen dramatically since the beginning of the 2000s. One-third of students in higher education now engage in some form of online study compared with only 10 percent of students 10 years ago (Statistiska centralbyrån, 2012). Currently around 30 universities out of 50 in Sweden offer online courses.

At the same time, however, the Swedish government is worried that the pass rate for online courses is lower than that for courses on campus. Indeed, the average pass rate in higher education in Sweden was 81 percent in 2012, but for online (distance) education, it was only 55 percent (Statistiska centralbyrån, 2012). This has given rise to strong expressions of concern about the future of online education in the Swedish context (Budgetpropositionen, 2012). The present study project was initiated at Dalarna University in response to these concerns.

2.2 Online education in Dalarna University

Dalarna University has a strong focus on synchronous online education that includes real-time instruction. At present, 72 percent of all students at Dalarna University study online. The university started to invest in online education in 2002, and this investment made the university one of the fastest growing institutes of higher education in Sweden. In 2011, Dalarna University decided to aim to be a leader in Next Generation Learning (NGL) by 2015. The Bill & Melinda Gates Foundation (2010) defines NGL as follows: “*the intelligent use of technology to develop innovative learning models and personalized educational pathways*”. The vision of NGL at Dalarna University is to develop and renew educational settings with the support of technologies. In 2012 and 2014, various NGL projects were established to investigate ways of improving the educational situations.

With the focus on online courses and NGL projects, the language department at Dalarna University expanded rapidly. Presently, 12 languages are taught there: Arabic, Chinese, English, German, Italian, Japanese, Portuguese, Russian, Spanish, Swedish and Swedish as a Second Language. Most courses in these languages are taught online using a web-conference system called *Adobe Connect* and a learning management system called *Fronter*, both of which are continually being improved through discussions with teachers to ensure optimum pedagogical quality.

2.3 What are pedagogical methods?

Hampel and Stickler (2005) claim that online language teaching requires different skills than face-to-face language teaching and that online language tutors (teachers) must therefore be aware of the differences and focus on how to utilize technology to ensure the quality of online education. The rapid development of online education at Dalarna University has turned the development of new pedagogical methods into a major challenge for teachers. Our research group was therefore established to explore the challenges and potential pitfalls of pedagogical methods used with online language education and to develop a portfolio of ideas for enhancing the quality of our education.

For the purposes of this project, pedagogical methods are understood in broad terms to include whatever teachers do to ensure that students attain the relevant learning outcomes. This includes planning, designing and delivering courses, knowing students’ abilities, guiding students, implementing activities, designing ways to give feedback, etc.

3. Methodology

The research is based on a qualitative and quantitative methodology. It was conducted in 2012 and 2014 by six language teachers. A questionnaire and in-depth interviews were used to collect data from both teachers and students in the language department at Dalarna University. The analysis of data collected

in 2012 is complete, while the data from the second part will be fully analyzed in the autumn of 2014. Subsequently, a comparative analysis will focus on alignments and misalignments between teachers' and students' perspectives. Based on this, the project will develop methods for the enhancement of the quality of online education.

3.1 Participants

3.2 The first project

The participants of the first phase were teachers in the language department at Dalarna University. Around 90 teachers teach approximately 200 courses in the 12 languages taught there. For this project, we focused on those who teach languages at the lower (beginners') levels. The main reason for this choice is that lower-level courses usually require more teacher support than higher-level courses. Thus, we hypothesized that both the benefits and the challenges with online teaching would be most visible in lower-level courses. Further, we estimated that these courses would have the most to gain from the development of new pedagogical methods suitable for online teaching environments.

After this preliminary selection, 23 teachers who teach lower-level courses focusing on oral and written proficiency were chosen to receive questionnaires. In addition, 11 teachers who specialized in pedagogy were chosen for in-depth interviews regardless of the courses they teach.

3.3 The second project

The participants in the second project are students in the language department at Dalarna University. In the beginning of May 2014, we sent out a questionnaire to around 2,300 students who were active in the online courses at that time. In addition, we aim to carry out 15 - 20 in-depth interviews with students for follow-up, in-depth interviews. These students will be chosen based on their language of study and level.

4. Findings

4.1 Findings from the first part - teachers' point of view

There was significant variation in the types of activities, lessons, materials and assignments that teachers used for online courses. Even so, in terms of having students reach the learning outcomes, it was commonly asserted that there is little difference between online education and campus-based education. The three most frequently raised issues were the following:

- Issue 1. No physical co-presence

Several teachers noted that the lack of physical co-presence with students was a disadvantage with online education. Even though this issue was not viewed as fatal in terms of having students attain the learning outcomes, many teachers said that it is easier to hold conversations in classrooms, while online classes feel less like a personal encounter, have a colder atmosphere and are less dynamic.

Some teachers put in extra effort to resolve this issue. They strive to create a comfortable atmosphere and a group feeling. For example, they make it obligatory to use web cameras, or they ask students to evaluate their courses regularly so that they feel part of the course. Some teachers also spend extra time early in the courses to help students get to know each other. Finally, some teachers apply the concept of "personalization" (Kawaguchi, 2004), which aims to persuade students to express their own ideas, opinions, feelings and preferences.

- Issue 2. How can we have a "lively debate/discussions" in *Adobe Connect*?

The second issue was how to create "lively debate/discussions" in classes using the web-conference system *Adobe Connect*. Teachers noted, for example, that "interaction is less spontaneous due to slow

connections; you have to turn microphones on and off” and that “debate is artificial because you have to talk in turns.”

On the other hand, some teachers did not find the technical issue insurmountable and were dedicated to making the debates or discussions active. They experimented by selecting and combining lessons: if students watch recorded seminars or if they hold discussions in the forum on LMS before the seminars, they will be prepared for discussion and will be able to begin the seminars at a higher level of engagement. Another idea was to divide students into smaller groups by using a tool in Adobe Connect, the “breakout room”, so that students can use their microphones all the time instead of turning it on and off.

- Issue 3. How can we decrease the dropout rates?

The third issue was the high dropout rates. Teachers noted that high dropout rates are a problem with online education and as such they strive to decrease these. Our analysis indicates two possible factors for such high rates. One is that there is a relationship between the dropout rates and the types of courses: the dropout rates are higher if the course is independent (not part of a programme) or if it is a course for complete beginners. The other factor relates to information. If information is difficult to find or communication is unclear, students lose their motivation.

Additionally, it is important that a clear course description is available before students register. Often in beginners’ level courses, students’ expectations and teachers’ expectations differ; some students have no academic intent, whereas teachers expect them to learn academic skills; therefore, it is important it be specified in advance as to what is required of students if they are to complete the course successfully.

4.2 Findings from the second part - students’ point of view

Since the second part is ongoing in 2014, the results will not be available until autumn 2014. Considering the three challenges raised by teachers, our focus in making the questionnaire was on learning about the social aspects of online education from the students’ point of view.

According to Moore’s (1993) transactional distance theory, “distance” is a psychological distance and this transactional distance has to be minimized if learning by distance is to be maximized. To maximize learning in online education, four types of interaction play important roles: learner-instructor, learner-learner, learner-content, and learner-interface. The questionnaire was constructed to investigate how students experience these four categorized interactions. The results will be presented in the oral presentation at the conference.

5. Conclusion

Even though the project is yet to be completed, we have a number of preliminary findings. First, no teacher mentioned that it is difficult to have students reach the learning outcomes in online courses. Hrastinski (2013) also claims that there is no scientific evidence that online education is of lower quality than campus-based education.

Secondly, no pedagogical method works perfectly for all students. That can be seen from the various methods which are used by language teachers at Dalarna University. Ramsden (2003) claims that a variety of methods should be used to ensure that all students, with their many learning differences, are able to develop their knowledge and understanding. Accordingly, an important role for the teacher is to carefully consider which tools and pedagogical methods will help individual students in their learning.

In online education, students are spatially separate, and this can lead to feelings of isolation. Thus, it is very important that teachers create a comfortable virtual-classroom atmosphere. This can be achieved by using activities where students interact with each other outside class. For example, “personalization” helps students to get to know each other, and “breakout rooms” rely on smaller groups of collaborating students. Hrastinski (2013) also explains that problems exist with web-based education since students can feel isolated: this might cause higher dropout rates compared with campus

education. He also argues that it is important that students get to know each other and feel comfortable with each other, especially in online learning situations.

Säljö (1992) argues that the interaction that occurs outside of class also plays an important role in learning. Learning occurs not only in the school environment, but also in all situations of interaction between people, such as at a dinner table, during coffee breaks, and so on. In the case of on-campus classes, it is easier for students to be connected and to continue their discussions after class. However, when it comes to online classes, students are disconnected when classes finish, which leads to fewer social contacts. Therefore, teachers of online courses have to try to create a sense of group during class so that students interact with each other spontaneously and enhance their learning even outside class.

The project *Pedagogical methods in web-based language teaching: students' point of view* is being conducted in 2014, and as such the results of this part of our project will be presented at the conference. We can end by quoting Ramsden (2003), who reminds us that: "Good teaching involves striving continually to learn about students' understanding and the effects of teaching on it." Thus, education is not about one-way communication from teachers to students; rather, it is about teachers and students engaging in a process of mutual learning.

Acknowledgements

We would like to express our great appreciation to the NGL Centre at Dalarna University for financing our project. In addition, we would like to thank all the staff at Prifloat who helped us with the questionnaire, and all the teachers and students in the language department at Dalarna University who participated in this project.

References

- Bill & Melinda Gates Foundation (2010). Next Generation Learning, The intelligent use of technology to develop innovative learning models and personalized educational pathways.
<https://docs.gatesfoundation.org/Documents/nextgenlearning.pdf>
- Budgetpropositionen för 2012. Utbildning och universitetsforskning.
<http://www.regeringen.se/content/1/c6/17/55/29/8a64611a.pdf>
- Distansutbildningar, Om distansutbildningar.
http://www.distansutbildningar.se/Distansutbildningar_Om_distansstudier__d677.html
- Hampel, R., & Stickler, U. (2005). New skills for new classrooms: Training tutors to teach languages online. *Computer Assisted Language Learning*, 18 (4), 311-326.
- Hrastinski, S. (2013). Nätbaserad utbildning - En introduktion (2nd Edition). Lund: Studentlitteratur.
- Kawaguchi, Y. (2004) Hyougenkyouiku to bunpoushidou no yuugou, "hatarakikakeru hyougen" to "kataru hyougen" kara mita shokyuubunpou. *Journal CAJLE*, (6), 57-70.
- Moore, M.G. (1993). Theory of transactional distance. In D. Keegan (Ed.) *Theoretical Principles of Distance Education*. New York: Routledge.
- Ramsden, P. (1993/2003). *Learning to Teach in Higher Education*. London, Routledge.
- Sharples, M., McAndrew, P., Weller, M., Ferguson, R., FitzGerald, E., Hirst, T., and Gaved, M. (2013). *Innovating Pedagogy 2013: Open University Innovation Report 2*. Milton Keynes: The Open University.
- Statistiska centralbyrån (2012). Distansutbildning i högskolan
http://www.scb.se/statistik/_publikationer/UF0543_2010T02_BR_A40BR1206.pdf
- Stickler, Ursula and Hauck, Mirjam (2006). What does it Take to Teach Online? Towards a Pedagogy for Online Language Teaching and Learning. *CALICO Journal*, 23(3)
- Säljö, R. (1992). Kunskap genom samtal. *Didaktik tidskrift* 2-3, 16-29.
- Universitets Kanslersämbetet (2013). Statistik Analys.
<http://www.uk-ambetet.se/download/18.575a959a141925e81d11773/Sjunkande-prestationsgrader-stannat-av-statanalys-nr11.pdf>
- Vygotsky, L. S. (1986). *Thought and Language*. Cambridge, MA: MIT-Press.

Knowledge Features of Peer Response Process

Siou-Lan WANG^{a*}, Calvin C. Y. LIAO^a, Chih-Yuan, SHIH^a, Tak-Wai, Chan^a

^a*Graduate Institute of Network Learning Technology, National Central University, Taiwan, R. O. C.*

*shirley@cl.ncu.edu.tw

Abstract: There is no doubt that peer response facilitates learning. Yet, the knowledge features in the process of peer response still need further identification. In this paper, we identify four knowledge features of peer response process through the connections of early grades' writing revision. In a suburban elementary school in northern Taiwan, a class of second grades participated the intervention of peer response on writing revision. Students reviewed the drafts from classmates and gave comments. After receiving comments from peers, writers went back revising the drafts. The result finds four knowledge features of peer response in early grades' writing response process. Moreover, early grades benefit more from the the knowledge that they learn from the peer response process than the knowledge from peers' explicit comments. Such findings have shed light on extending the knowledge of peer response process.

Keywords: knowledge features, peer response, writing revision

1. Introduction

Peer response have considered helpful to improve learning through social interaction with peers. Thus, the knowledge, experience, suggestions sharing from peers are reasonably considered as explicit knowledge resource. Mostly, research that adding the element of peer response attributed the improvement to peers' tutoring, response, or supports. It is plausibly right, but seems to over-generalize the power of peers. Indeed, peers' power is unneglected in the process of peer interaction, while it is risky to jump to the conclusion that peers' support is the only reason of individual success in the peer interaction context.

Before distinguishing the reason of individual's success in the peer response context, the knowledge features that channeling in such contexts should be identified ahead. How students gain knowledge or in what ways that facilitate their knowledge acquisition have been concerned and investigated for the researchers of education in decades. Specifically, some researchers (Dienes & Perner, 1999; Willingham & Goedert-Eschmann, 1999) considered that knowledge can be explicitly and implicitly learnt or gained. Generally, implicit learning refers to the learning that is unaccessible and non-verbalized performance, which can only be inferred through intact clues. Explicit learning, in contrast with implicit learning, refers to the learning that is accessible and could be verbalized by the participants, such as knowledge that can be recalled in the tests. Berry & Broadbent (1988) further indicated that implicit learning would happen when target knowledge was revealed without indication of the purposes. They conducted experiment to show the subjects certain learning materials and did not request them to learn or memorize it. Afterward, students were able to implicitly apply the learning on the following tasks. It can be considered that the appearance of learning materials can also cause implicit learning.

Since we bring the issue of social interaction in into implicit and explicit learning, the influence source of students' knowledge learning needs to be further considered. Harris, Graham, and Mason's (2006) study drew the conclusion that second grade students' writing performance were able to improve under the condition of Self-Regulated Strategy Development (SRSD) and also benefit from peers' support. In their study, students' were explicitly instructed self-regulation strategies. Meanwhile, with the addition of peer support in this study brought "incremental" effect on students' writing. Though they attributed students' performance to self regulation and peers' support, they failed to further investigate whether individual student's writing increment was resulting from individual change on the peer-supported process. Thus, drawing from the knowledge sources and the knowledge representation, we identify four knowledge features to help clarify the knowledge in the peer response process.

In this study, we refer to the definition of previous studies about explicit and implicit knowledge. For the definition of explicit knowledge, we consider it is either visible or fit the purpose of telling; for the implicit knowledge it is considered as either not visible or the purpose of telling varies (referring to Berry & Broadbent, 1988).

- Explicit peer knowledge (EPK): Peers' knowledge is visible and the receiver takes and applies it in the appropriate context.
- Implicit peer knowledge (IPK): Peers' knowledge is visible but the it has been known by the receiver ahead. Hence, peers' knowledge is no longer as a new but serves as a implicit reminder to the receiver.
- Explicit self knowledge (ESK): personal knowledge is visible but it is the only connection of one's own following performance.
- Implicit self knowledge (ISK): personal knowledge is not visible but it affects one's following performance. It is considered the influence of involving in the learning contexts.

To exam the potential of knowledge features in peer response process, we conduct the intervention of peer response on second grade students' writing revision. The purpose of this study is to identify the knowledge features through connecting students' writing revision with the receiving and giving comments. While in the nature of learning writing, we choose early grades for their possibility of developing the social support on achievement motivation and learning (Rohrbeck , Ginsburg-Block , Fantuzzo , & Miller, 2003). Besides, in order to fulfill the peer response interaction of students' writing revision, personal laptop connecting to the pre-designed writing system is necessary to facilitate comment exchanging and writing revision.

2. Method

2.1 Research context and procedure

The present study is conducted under an authentic classroom learning context. It is an ongoing project conducting on eight classes of second grades in a suburban elementary school in northern Taiwan. Each class contains about 30 students. All participants are native speaker of Chinese. Students in the school began using tablet PC with keyboard to do web-based learning tasks (Chinese typing tasks, math learning tasks, reading and writing tasks) from the first grade. In the regular writing task, students need to generate four stories or essays on the Drawing and Writing System (Liao & Chan, 2013) during the semester. To facilitate the process of peer response on writing, a sub-system was built upon the Drawing and Writing System, named Writing Response System (Wang, Hsieh, Liao, Shih, & Chan, 2013). Each students can give and receive comments online through this system. When revising the writing, the system allows students to check peer comments at the same time. Last, this system also provides scaffolding prompts for students to use during giving feedback.

In this paper we selected a class of second grades to give intervention of peer response on writing draft for initial trial of peer response on writing revision; we intend to see how students initial response on such activity. To help students effectively improve writing, the intervention of peer response for writing revision was arranged in December, 2012. The intervention were processed without interfering regular writing tasks. During the intervention, Students had already completed two drafts, which titled *A day of Father* and *Firework*. Before the intervention, a ten minutes mini-lesson was provided to teach students the essentials of group peer response (how to review and give comments on peers' drafts, the appropriate matters to orally share thoughts with group members, and how to revise personal draft according to receiving comments) for writing revision.

Before the intervention, students were arranged as groups (about four student as a group). The intervention was firstly reviewing drafts of group members and giving comments through Writing Response System. Second, writers in each group orally read the self-draft and group members gave comments typing on the Writing Response System. After all group members shared and received comments face-to-face, each student went back to the draft and revise it.

2.2 Data collection and analysis

In order to investigate the knowledge features through the connection between writing revision and the comments, all revision logs and giving and receiving comments are saved on the Writing Response System. For the revision logs, writers are able to click “save” after they change any part of the draft. It represents as different versions of change. For example, when one student have three revision logs, it means the student have three saved versions of the the same writing. Hence, the researchers are able to identified the parts that are revised and further connecting to comments.

For the comments, students also save them as soon as they type it on the comment section. After the intervention, the researchers examine each comment and exclude invalid ones (no words and symbols, duplicated comments, making jokes or misusing the prompts). On the other hand, since the comments from the second grade students were simply containing one unit idea, unlike older students that may carry more than one unit idea in the comments (Cho & Cho, 2011), each comment is taken as carrying one unit in this study. Further, data is organized by each student. That is, each writer have the records of giving comments, receiving comments, and revision logs. After data is organized, the researchers triangulate revision logs with comments.

The procedure of connecting the revision logs and comments is described as follows. First, every revision logs and comments are listed in accordance with each student. Second, revision parts are identified from each log. Third, writers’ giving and receiving comments are reviewed one by one to see whether they could connect to the revision logs. According our hypothesis of knowledge features, we identify the connecting types revision and comments enclosed with description of each types in Table 1:

Table 1: Knowledge features identifying from the data.

Explicit peer knowledge: Connecting to receiving comments	
Description	When revision connects to the comments explicitly receiving from peers (peers’ knowledge about writing) suggesting to the revision contents.
Example	[Original version] 小明趕快打電話請消防車請消防趕緊到現場。 Ming urgently called the firefighter and asked them to come right away. [Revision log] 小明趕快打電話請 119 請消防趕緊到現場 消防隊很緊張的說：別急！別急！我會盡快趕到的。
	Ming urgently called 119 to the firefighter and asked them to come right away. The firefighter said nervously: Clam down, I will get there as soon as possible.
	[Receiving comments] 我覺得你對角色的描述可以再仔細點像是，字太少了。 I suggest you describe the characters precisely, you need to write more.
Implicit peer knowledge: Connecting to Giving & Receiving comments	
Description	When the revision connects to the comments both given from the writer to group member and those from peers suggesting to the revision contents. Both giving and receiving comments can be connected to the revision logs. It fits the feature of implicit peer knowledge because the receiving comments (peer knowledge) is similar with the giving comments (the writer has known). Thus, the receiving comments serve as an implicit reminder the the writer of what s/he has known about writing.
Example	[Original version] 爸爸教導我的方式比較嚴格，他常說：「事不過三」，事情犯錯只有兩次機會，第三次犯錯就會處罰。 The way Dad teaches me was strict. He often say “three and out.” You are only allowed to make the same mistake twice and will get punished in the third time. [Revision log] 爸爸教導我的方式比較嚴格，他常說：「事不過三」，事情犯錯只有兩次機會，第三次犯錯就會處罰， 所以我最多只有做到第二次。
	The way Dad teaches me was strict. He often say “three and out.” You are only allowed to make the same mistake twice and will get punished in the third time, so I only make it twice.
	[Giving comments] 我覺得你故事內容太少，像第三篇和第四篇，內容只有一點點。 I think the content of your story is insufficient. For example, the content of the third and fourth paragraph are few. [Receiving comments] 字太少。 The amount of words is insufficient.
Explicit self knowledge: Connecting to giving comments	
Description	When revision connects to the comments (background or learnt knowledge about writing) explicitly giving to group members but afterward the comments as a reminder to affect his/her

	own revision (one's own performance). The comments may not be directly suggesting the same but similar problems.
Example	[Original version] 他趕快拿起手機，打 119 告訴消防隊。 He grabbed the phone and called the firefighter.
	[Revised log] 小新趕快拿起手機，打 119 告訴消防隊 Sin grabbed the phone and called the firefighter.
	[Giving comments] 你的字有些打錯了。 Some words in your draft are wrong.
Implicit self knowledge: Connecting to neither comments	
Description	When the revision (one's following performance) connects to neither giving nor receiving comments. It is inferred that the writer is influenced by the peer response process.

3. Results and Discussion

The purpose of this study is to identify the knowledge features of peer response process in the context of early grades writing revision. For connecting the revision and the comments, the analysis results is focused on the students who revised the writing drafts.

3.1 Overview of the results

In order to identify peer response knowledge features through observing how early grades act in peer response on writing revision, we observed their overall performance on two interventions. Specifically, we found that the revision results from each students can be separated as revising and not revising the drafts. Hence, we divided the data into the groups of Revising Writing Students (RWS) and No-Revising Writing Students (NRWS) (Table 2). On the other hand, among all the comments collecting from students, we found that some comments were meaningless or duplicated. Hence, we decided to exclude from the analysis. For the invalid comments, one may consider the possibilities of including them into analysis. The reason we did not adapt them in the analysis was for their complexity. As mentioned in the section of data collection, the invalid comments were those with no words and symbols, duplicated comments, jokes or misusing the prompts. The cause of giving these kinds of comments might be because students' personality, the misuse of the system, or classroom cultures. Although we agree that these factors may influence peer response activities, such extension is beyond our purpose of investigation of peer response on writing revision. Thus, we only analyzed the comments that referring to the writings. Further, the comments divided as comments giving to peers and receiving from peers. Generally, students performance on the second intervention improved (see Table 2).

Table 2: Descriptive information of all students data.

Groups	Interventions	<i>A day of Father</i>			<i>Firework</i>			
		Comments	N (%)	M	SD	N(%)	M	SD
RWS	Number of RWS		14			23		
	Original giving comments		86 (100%)	6.14	6.71	114 (100%)	4.96	4.04
	Filtered giving comments		34 (40%)	2.31	1.38	85 (75%)	3.70	2.53
	Original receiving comments		79 (100%)	5.64	4.36	124 (100%)	5.39	3.81
	Filtered receiving comments		34 (43%)	2.43	1.02	84 (68%)	3.65	2.60
NRWS	Number of NRWS		13			4		
	Original giving comments		92 (100%)	7.08	9.79	23 (100%)	5.75	6.18
	Filtered giving comments		43 (46%)	6.14	3.54	12 (52%)	3.00	0.82
	Original receiving comments		99 (100%)	7.62	7.52	13 (100%)	3.25	0.50
	Filtered receiving comments		36 (36%)	5.14	1.59	12 (92%)	3.00	0.82

*Revising writing students (RWS), students who revised their drafts; No-Revising writing student(NRWS), students who did not revise their drafts.

3.2 Knowledge features: the connection between revision and comments

Since we intend to investigate the connection between revision and comments to identify the knowledge features of peer response, the data of revision logs is firstly presented (see Table 3). Overall, the amount of revision logs improves more than two times (from 44 to 106 logs). For the revised words, it varies from 408 to 1049 words. Both the giving and receiving comments increased two times as well.

Table 3: Descriptive information of the writing draft revision.

Writing topics	<i>A day of Father</i>			<i>Firework</i>		
	N	M	SD	N	M	SD
Revision logs	44	3.14	1.92	106	4.61	3.59
Revised words	408	29.14	37.98	1049	45.61	44.78

We connects the revision logs and all comments. The results of connection of writing revision with comments are presented in Table 4. As mentioned previously, the connection between revision and comments are coded as four knowledge features. For EPK, which affected writers' revision from peers' suggestions, the percentage decreased from 40 to 19. For IPK, it affected writers' revision from both prior knowledge and peers' suggestions, is increased from 16 percent to 23 percent. For ESK, which affected students' revision from prior revision knowledge, there were only 7 percent of the logs in the first peer intervention, while it increased to 26 percent in the second intervention. It shows that writers' giving comments became more relevant to the self-draft revision. For ISK, it reveals 37 percent at the first writing while slightly decreased in the second writing (32 percent).

First, EPK in the data is considered that students' revision benefit explicitly from peers' knowledge though peers' comments. The percentage of revisions connecting to peers' comments reduces in the second peer response activity. It may imply that the writer learn the revision knowledge from peers' comments at the first draft revision but it reduces for the limits of early grade peers' revision knowledge. Hence, writers benefit less from peers because peers can give few newer knowledge in the second draft resulting from their insufficient revision knowledge.

Second, IPK is shown that the revision increasingly connected in the second draft. It can be interpreted that writers have gained more knowledge about writing from first intervention. In the second intervention, writers have obtained more knowledge than in the first intervention. Thus, in the process of checking peer comments, the peer-provided writing revision knowledge serves as a reminder to the writers of what they have learned. Consequently, writers' prior and obtained knowledge are retrieved and implicitly guiding them to revise their writings.

Table 4: The connecting of writing revision with comments.

Writing topics (interventions)	Connecting to Receiving comments (EPK)	Connecting to Giving & Receiving comments (IPK)	Connecting to Giving comments (ESK)	Connecting to no Comments (ISK)	Revision logs
	N (%)	N (%)	N (%)	N (%)	N (%)
<i>A day of my dad</i>	17 (40%)	7 (16%)	3 (7%)	16 (37%)	43 (100%)
<i>Firework</i>	20 (19%)	24 (23%)	27 (26%)	34 (32%)	105 (100%)

Third, ESK is referred that students' revision benefit explicitly from writer's own knowledge though the comments this writer gave to others. The comments that connecting to comments the writers giving to peers increase in the second draft revision. It may be interrelated as the writers acquire the revision knowledge through the peer response process and apply the skills in the second draft revision.

Fourth, ISK considered that students' revision benefit implicitly from the peer response on writing revision itself. From the analysis result, the revision connecting to no comments decrease only 5%, indicating that about one third of revisions were not referred to author's and peers' comments. It can be implied that early grades perform similar trend of writing revision preference to older students.

In summary, the peer response process helps early grade students develop implicit self knowledge. In addition, students benefit from the implicit self knowledge more than the explicit peer knowledge. Peers' comments play a weaker role was because of the lack of newer knowledge that early grades can provide in the second peer response intervention. Last, peers' comments implicitly stimulate writers' knowledge through the whole peer response process. Writing revision through the influence of prior knowledge and peer knowledge enables students to retrieve the revision knowledge and practicing it on the drafts.

3.3 Conclusion

The purpose of this study is to identify the knowledge features in the process of peer response. Specifically, we design a context of early grades' writing revision facilitated by peer response. From the result of data analysis and discussion, we identify four knowledge features from the connection between writing revision and peer comments, which are explicit peer knowledge (EPK), implicit peer knowledge (IPK), explicit self knowledge (ESK), and implicit self knowledge (ISK). It is concluded that early grades learned writing revision knowledge from the provided scaffold prompts, peers' comments, and the peer response process. Moreover, early grade students benefits more from the peer response process (ISK) than from peers' comments (EPK). Thus, for early grades, giving comments may play a major role of constructing knowledge through interaction while the comment itself may only play a minor role in the revision performance.

The identification of the knowledge features of peer response process makes it clear that students in the peer response process benefit from different knowledge sources. Researchers of related studies should start concerning the knowledge channeling in the process of peer response and clarify how students get improved by. Eventually, the picture of knowledge features in peer response learning can be completed.

Acknowledgements

The authors would like to thank the National Science Council of the Republic of China, Taiwan, for financial support (MOST 101-2511-S-008 -016 -MY3, and MOST 102-2811-S-008 -009 -), and Research Center for Science and Technology for Learning, National Central University, Taiwan.

References

- Berry, D. C., & Broadbent, D. E. (1988). Interactive tasks and the implicit-explicit distinction. *British journal of Psychology*, 79, 251-272.
- Cho, Y. H. & Cho, K. (2011). Peer reviewers learn from giving comments. *Instructional Science*, 39, 629-643.
- Dienes, Z., & Perner, J. (1999). A theory of implicit and explicit knowledge. *Behavioral and Brain Sciences*, 22, 735-808.
- Harris, K. R., Graham, S., & Mason, L. H. (2006). Improving the Writing, Knowledge, and Motivation of Struggling Young Writers: Effects of Self-Regulated Strategy Development With and Without Peer Support. *American Educational Research Journal*, 43(2), 295-340.
- Liao, C. C. Y., & Chan, T. W. (2013). Exploring a Self-generated Drawings Environment to Facilitate Children's Writing and Storytelling, *Proceedings of the AECT International Conference on the Frontier in e-Learning Research 2013*. Taiwan: National Central University & AECT.
- Rohrbeck, C. A., Ginsburg-Block, M. D., Fantuzzo, J. W., & Miller, T. R. (2003). Peer-Assisted Learning Interventions With Elementary School Students: A Meta-Analytic Review. *Journal of Educational Psychology*, 95(2), 240-257.
- Wang, S.-L., Hsieh, Y.-T., Liao, C. C.-Y., Shih, C.-Y., & Chan, T.-W. (2013). Exploring the Capability of Second Grade Students in Peer Response on Writing Revision. In Wong, L.-H. et al. (Eds.), *Proceedings of the 21st International Conference on Computers in Education*. Indonesia: Asia-Pacific Society for Computers in Education.
- Willingham, D. B., & Goedert-Eschmann, K. (1999). The relation between implicit and explicit learning: Evidence for parallel development. *Psychological Science*, 10 (6), 531-534.

Real-time Feedback Systems in a Foreign Language Teaching: A Case of Presentation Course

Yuichi ONO^{a*}, Manabu ISHIHARA^b, Sachio HIROKAWA^c & Mitsuo YAMASHIRO^d

^a*Foreign Language Center, University of Tsukuba, Japan*

^b*Department of Electrical and Information Engineering, Oyama National College of Technology, Japan*

^c*Research Institute for Information Technology, Kyushu University, Japan*

^d*Department of Systems and Information Engineering, Ashikaga Institute of Technology, Japan*

*ono.yuichi.ga@u.tsukuba.ac.jp

Abstract: This paper is concerned with a new type of real-time feedback system in a classroom based on the text data collected from the audience. After reviewing two traditional approaches to real-time feedback; the Clicker Approach and the Forum Approach, it will be suggested that either of them is insufficient as a tool to motivate the learners in a case of presentation course. Instead, we propose two systems on the basis of text-mining technique to compensate for these insufficiencies. The first is a “Keyword and Frequency” system and the other is “Mind-mapping” system. In this paper, we describe the details of the systems. By being presented the keywords and data on frequency, the presenters can easily understand about the general feedback tendencies. In addition, the mind-map picture gives the presenters the opportunities of promoting a new awareness, various kinds of discoveries, and a deeper reflection about their works. Totally, our system can be incorporated into Learning Management System (LMS), and it has a large potential for further use in a distant learning environment to capture an overall reaction from the audience all over the world.

Keywords: real-time feedback, text-mining, keyword and frequency, mind-mapping, presentation course

1. Introduction

This paper is concerned with the implementation of text-based feedback system with focus on foreign language presentation course. The importance of feedback for learning has been mentioned in the literature, emphasizing its role in fostering meaningful interaction between students and instructional materials (Buchanan, 2000), its contribution to students’ development and retention (Yorke, 2001) and students’ participation and engagement in the class tasks and activities (Ono, Ishihara and Yamashiro, 2014).

This paper starts the review of the traditional approach to real-time feedback. There have been two proposals made in the literature: the “Clicker” approach and the “Forum” Approach. The former approach usually makes use of multiple-choice questions created by the instructor beforehand. In this sense, we can call it the “Quantitative” Approach. On the other hand, the latter utilizes the “Bulletin-board” usually incorporated into Learning Management System (LMS). The raters just make free comments on the board and it is reflected on the screen in the classroom. We can call this the “Qualitative” or “Bulletin Board” Approach in this sense. In a Moodle, a typical example of familiar Learning Management Systems, the bulletin-board mode, named “Forum”, takes this role under the class management. As will be reviewed in the following section, these two traditional approaches are very popular. However, we would like to mention that either of them is insufficient in terms of presenters’ motivation. Instead, we propose our text-mining approach to desired purposes.

2. Backgrounds

2.1 The Role of Real-time Feedback

It is commonly agreed that learning is more effective when interaction occurs between learners. (Hentea, Shea, & Pennington, 2003; Schmieder, 2008). In a case of foreign language teaching, making presentation provides students with an opportunity to reconsider their approaches to critical thinking, problem solving, collaborative learning, speaking, and writing. Instant feedback activities that engage the audience are one method of encouraging active learning for both presenters and their audience. By providing feedback immediately after a student completes his or her presentation, the experience is more authentic, and occurs precisely when he or she is the most receptive to criticism, coupled with the excitement of the reaction (Ono, Ishihara & Yamashiro, 2014: p.2). Improving the quality of instant feedback activities can motivate students to become more involved in the learning process. Various kinds of tools have been introduced in order to guarantee the “interactivity” and “quality” of the feedback in a large-size classroom. In the following subsection, we review two of such major tools for real-time feedback.

2.2 Traditional Approaches

There are two major approaches to real-time feedback system. One approach is “Quantitative” and the other is “Qualitative”. In the first approach, the instructor or lecturer prepares a multiple-choice question that is displayed in the classroom. Students answer or click the number of their choice. Then, the statistic results (number, average, etc.) were shown on the screen. The second type is the use of bulletin-board. Recently, the use of Social Network Service (SNS) has been reported.

2.2.1 Quantitative Approach: Use of “Clicker”

A commonly-used device for this approach is “Clicker”. It can be referred to as “Audience-Response Analyzer (ARA). This system involves multiple-choice questions created by the instructor beforehand. Even in non-wired classroom, the recent analyzer makes it possible to receive the responses from the audience by setting up teacher’s PC, response receiver, and a lot of response senders. The picture of “Clicker”, a sender and a receiver, is given in Figure 1, and that of its output of the system is given in Figure 2.



Figure 1. Picture of “Clicker”

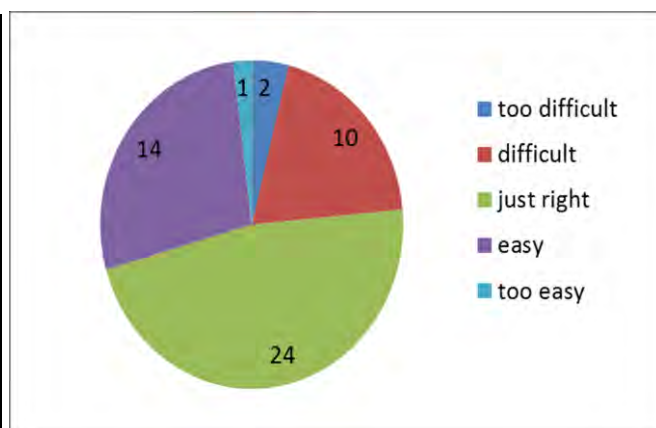

Figure 2. Picture of Output

Although Clicker has been spread world-wide including Japanese classrooms, this approach tends to be based on highly quantitative output and its descriptive statistics. The question items for instant feedback tend to be multiple-choice questions, voting questions among, say, five candidates, or consciousness surveys on the five-point Likert scale. In the case of feedback of presentation course, clicker questions tend to be 5-point Likert questions like “Pronunciation is good”, or “Visuals are helpful” and so on. The more deeply we need to know the results on the basis of assessment rubrics, the

more detailed question items we need to ask the audience. And students have to answer all of them in, say, three minutes.

2.2.2 Comment List Approach: Use of Bulletin Board

Here comes the role of open-ended questionnaire. Instead of showing the statistic ratings of each question items, the presenter can recognize what the audience felt about their presentation directly from their feedback comments. Actually, this is an easy way to do, because the common SNS or bulletin-boards installed in LMS are now available to instructors given net environment in the classroom. Since the concept of “Social Interaction” and the social learning approach has been widely spread, the use of SNS (Twitter, Facebook, Line, and so on) has become much easier for everybody including students and instructors. When we consider the effective feedback activity in a presentation course, it is reasonable to use this technology as an instant feedback tool (Hasegawa, Yasui & Yamaguchi, 2013).

However, if this is a large class, say, more than 100 students are enrolled in the course, using a large classrooms, the presenter have to take a look at 100 feedback comments one by one. It might be difficult to understand the general tendency about the presentation from a list of raw feedback comments. Uncontrolled feedback comments might appear on the screen. The instructor must give sufficient instruction on what kinds of comments should (not) be posted for feedback activity. The use of LMS can remove this risk, but it is not certain that the system can draw only acceptable text data from the audience. The point here is that we need to provide a certain level of analysis so that the whole comments can encourage the presenter to try for the next trial.

2.3 Proposal: Text-mining Approach

On the face with insufficiencies of two traditional real-time feedback approaches, we would like to propose an alternative feedback system on the basis of text-mining technology. The basic concepts of our proposal are given below:

- . --- Real-time process of analyzing collected raw text data
- Produce tendency graphs according to keywords or categories prepared by the instructor previously
- The use of natural language processing (text-mining) method to pick up keywords
- Reference to the original feedback comments by presenters

The first trial is for producing graphs of results on frequency of the given keywords. The schematic outline of the proposed system is described in Figure 3 below:

The analyzer has to recognize the dependency relations between words. CaboCha is a high-level free Japanese syntactic parser, which enables us to analyze syntactic dependency of Japanese sentences. CaboCha was employed in our system for analyzing dependency relation of a sentence. The process is driven with `proc_open()` function and the package is installed in the activity module of our Learning Management System (LMS); Moodle. This is shown in Figure 4.

Usually text-mining is conducted offline; a certain amount of time is spent after the class to analyze and derive important clusters of meaningful concepts from text data through statistical processes. Since our system is constructed with the intention that the feedback is given soon after the input by audience is finished. Therefore, we just concentrated on the use of descriptive aspects of statistics as an output of the system. The system is implemented in Moodle as one activity session. This makes the students work on this activity even outside the classroom. The students can refer to their results of text-mining since it is stored in DB. In addition, they can make reference to original text data the audience gave to the DB to make their points clearer.

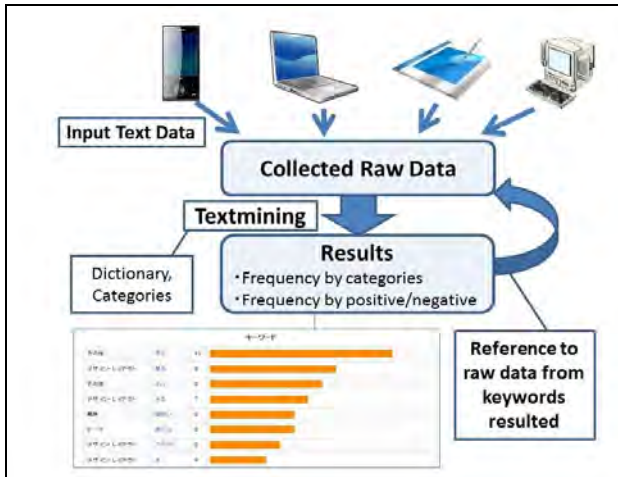

Figure 3. Outline of the System

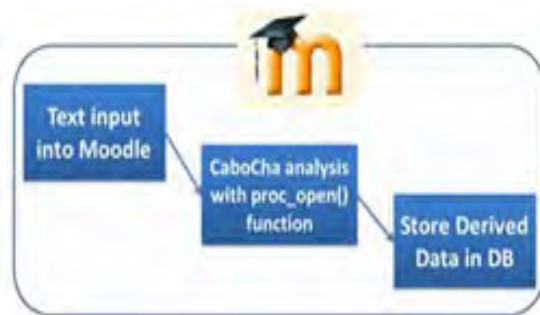

Figure 4. System Structure

2.3.1 Keyword and Frequency Approach

In order to process text data for our purpose, the author created a dictionary for evaluation. For selecting lexical items, the actual text data collected when the pilot study was carried out previously were used. 50 students participated and made open-ended comments on each of ten presentations. After analyzing these data by CaboCha, around 410 lexical items were selected and two kinds of properties were given to each item. These properties were (i) properties on impression and (ii) properties of semantic categories like “design/layout”, “interest”, “English”, “pronunciation”, “citation”, and “others”. The file of our evaluation dictionary is shown in Figure 5. All the audience have to do is to write down the picture of input box. The presenter was given the feedback output soon after the presentation is finished, as shown in Figure 6, where the results are shown in a graphs and a radar chart. The result of Figure 6 includes the ratio of positive/negative words appearances and number of frequency of each semantic category. In addition to this, the student (presenter) can make reference to the original text data by clicking the key words. This is shown in Figure7.

	A	B	C	
37	英語	発音	聞き覚え	0
38	英語	発音	語	0
39	英語	発音	聞き取る	1
40	英語	発音	発音	1
41	英語	発音	英語	1
42	英語	発音	聞く	1
43	英語	発音	スピード	1
44	英語	発音	声	1
45	英語	発音	話す	1
46	英語	発音	大きい	1
47	英語	発音	話し方	1
48	英語	発音	聞	1
49	英語	発音	追える	1
50	英語	発音	音声	1
51	英語	発音	流畅	1
52	英語	発音	丁寧	1
53	興味		飽きる	-1
54	興味		わむたい	-1
55	興味		自分	0
56	興味		作品	0
57	興味		弓く	1
58	興味		良い	1
59	興味		楽しい	1
60	興味		面白い	1
61	興味		いい	1
62	興味		集中	1
63	興味		おもしろい	1

Figure 5. Evaluation Dictionary

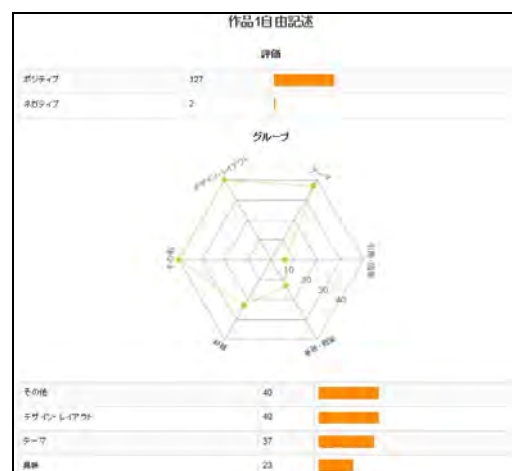

Figure 6. Feedback Graphs and Charts

種 / 名	フィードバック
テスト019 マイニング	少し韓国映画の面白い部分を書いているスライドが多かったのが残念でした。でもグラフィックもあって 話が読べらなっています...
テスト029 マイニング	あがってとてもわかりやすかったです。スライドのデザインがセンスあると思いました。内容も興味のかかるものでした...
テスト030 マイニング	韓国映画はあまり好きではなかったのですが、D-WARS見てみたいと思いました。スライドがとても見やすかったです。

Figure 7. Reference to Original Comments (Keywords Reference)

2.3.2 Mind-mapping Approach

The proposed keyword and frequency approach has an advantage of providing information of what kinds of keyword audience picked up about the presentation, not just as an average score of a question item. However, the output results of this system have no consideration on the relatedness among keywords or frequency of co-occurrence between words; our system just shows a frequency of the keywords themselves. The collected text data should be shown so that the concepts or ideas of the audience can be visualize schematically as a mind map. This might help instructors to have an insight into the audience’s conceptual models from plain text comments.

According to Flanagan, Yin, Inokuchi & Hirokawa (2013), drawing a mind map can be thought of as a problem of searching one-by-one for related keywords, starting in the center with the keyword or image that is central to the concept. The related keywords or images are reiterated and expand in a radial pattern, linking back to the central concept through contextual relations. Our mind map of a word was constructed through the depth-first-search procedure. Given a word w , firstly we obtain the set of documents that contain the word w . Then, we extract the characteristic words of the documents set according to the relevance degree. In the present paper, we adopted the SMART measure by Salton & McGill (1983). The top K words are selected according to the measure. Each word u_i in the feature words is then used to "AND" search by " $w u_i$ " and a new node with the label " u_i " is linked from the root whose label is " w ". We repeat this process until the depth reaches the fixed parameter D . Note that a word is checked once it is used in search keyword. Thus, a word appears only once, and the graph becomes as a tree. A sample map is shown in Figure 8 below.

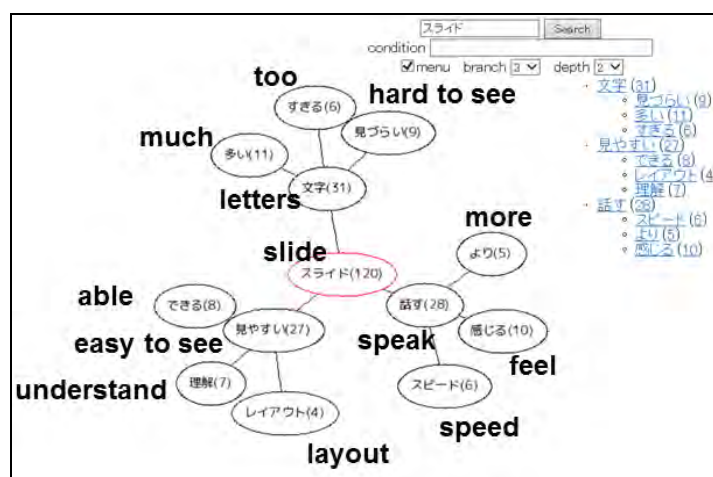

Figure 8. A Sample of Mind Map

In this sample, a presenter is interested in how his “slide”, which is located at the center of the map, appeared in the feedback from the audience. The mind map output shows that the word “slide” is related to three words; “letters”, “easy to see”, and “speak”. The last keyword “speak” might be a new finding for learners, since “slide” has a relationship with “speaking”. This might be a striking suggestion

because they might not be aware that the speed of speech helps the audience have a focus on their slide. Conversely, the new finding might include that speaking too fast does not allow the audience to see their slides comfortably. This type of analysis is not brought about from the simple list of free comments unless several participants directly made comments this way.

3. Concluding Remarks

Since this new mind map feedback has an advantage over simple list of comments as in Forum approach or frequency based text mining feedback, the next step of this study is to examine how effectively the mind map can be integrated into the course or instructional design. Other issues involve the development of dictionary according to the topic to be presented. More and more keywords related to the topic of presentation must be stored in the dictionary. A longitudinal data collection will tell us the process of change of concepts behind the feedback. Topic effects and proficiency effects might be visualized in the form of change of structures in the mind maps. We would like to research on these issues one by one in the near future.

Acknowledgements

This study was partially supported by Grant-in-Aid for Scientific Research No. 26370656, No. 24500176, and No. 25350369 from the Japan Society for the Promotion of Science (JSPS).

References

- Flanagan, B., Yin, C., Inokuchi, Y. & Hirokawa, S.(2013) Supporting interpersonal communication using mind maps, *Information and systems in education*, 12(1), 13–18.
- Hasegawa, S., Yasui, A. & Yamagucgu, M. (2013) Educational Use of the Social Networking Service and Social Learning, *Research Report of Nagoya Bunri University*, 13, 51-58.
- Hentea, M., Shea, M. J., & Pennington, L. (2003). A Perspective on Fulfilling the Expectations of Distance Education. Proceedings of the 4th conference on Information technology curriculum (pp. 160-167). Lafayette, Indiana, USA: ACM
- Ono, Y., Ishihara, M., & Yamashiro, M. (2014). Instant Text-Based Feedback Systems: The Development of a Text-Based Feedback System and Its Potential Use in Foreign Language Teaching, *Journal of Information Technology and Application in Education (JITAE)*, 3(1), 1-8
- Salton, G., & McGill, M. J. (1983) *Introduction to Modern Information Retrieval*, McGraw-Hill
- Schmieder, E. (2008) Communication: The tool to interact with and control your online classroom environment, *International Journal of Instructional Technology and Distance Learning*, 5(3), 39-50.
- Yorke, M. (2001) Formative assessment and its relevance to retention, *Higher Education Research and Development*, 20(2), 115-126

Sauce for the Goose?

Testing SVECTAT in Japan and Taiwan

Mark ELWELL^{a*}, Tsun-ju LIN^b, Steven COOK^c, Carlos MARTIN^d, J-C TERRILLON^c
& Yu-ju LAN^d

^a*Hakusan International School, Japan*

^b*Kainan University, Taiwan*

^c*Japan Advanced Institute of Science & Technology, Japan*

^d*National Taiwan Normal University, Taiwan*

**markelwell@hakusaninternationalschool.com*

Abstract: Shared Virtual Environment Complementing Task Achievement Training (SVECTAT) uses authentic task-based communication in Second Life to provide practicum for classroom language learning. SVECTAT has been found effective and efficient in improving functional ability and confidence. Here we present the results of parallel experimental sessions using SVECTAT for English language learners in two different countries, Japan and Taiwan, with the purpose of identifying differences in results and possible reasons for them. We find implications for broader use of this type of language learning method.

Keywords: English as a foreign language, task-based language learning, technology enhanced language learning, Second Life, shared virtual environment

1. Introduction

Language learning and language teaching face a daunting gap between classroom activities and independent authentic communications. Compounding this, in most cases, learners are not located in a target language environment. Another profound challenge lies in the limited resources available in formal teaching situations, particularly those of time and individual attention.

Task-based language learning (Prabhu, 1987) focuses on authentic language use in the achievement of meaningful tasks. It targets self-efficacy taking place in context (Lan, 2014; Lan et al. 2013). This method is found to be effective in developing fluency and confidence (Ellis, 2003). Shared Virtual Environment Complementing Task Achievement Training (SVECTAT) implements task-based language learning using the online service Second Life as a medium for learners to apply classroom learning to independent communications in an authentic target-language community based on achievement of meaningful tasks (Elwell et al., 2009).

In multiple tests, carrying out communication tasks through the medium of Second Life has lowered the learner's sense of stress and risk, while increasing the learning value of the instructional time (Cook et al., 2010). Those tests, however, were conducted by a single research team at a single institution, and indicated a need for broader testing to evaluate the value of the method (Elwell et al., 2010).

Here we report on a test of SVECTAT for task-based situated language learning. We conducted parallel experimental sessions in two different countries and teams with graduate students learning English as a foreign language, with the purpose of identifying differences in results and possible reasons for them.

This paper will summarize the method and previous results of SVECTAT. Next, we will present the methodology and results of our parallel experimental sessions in Japan and Taiwan. Then, we will discuss differences in the performance of the different groups of subjects, and possible reasons for them. Finally, we give a conclusion and references.

2. The SVECTAT Method

The SVECTAT method consists of classroom exercises based on achievement of meaningful communication tasks, complemented by authentic achievement of those tasks using the medium of the shared virtual environment of Second Life to meet and interact with actual users of English in an open social situation.

Instructors or facilitators first introduce the exercise to a group of learners and present a list of communication tasks, such as “Make a date or appointment” or “Pass a message”. They then model sample tasks, and both language content and strategies for achieving them.

Next, the learners practice the sample tasks with the instructors or facilitators, and with each other. Scaffolding changes form and even strengthens, but prepares learners for when it is removed.

Finally, the learners enter a public social venue in Second Life and interact with users to achieve tasks from the list provided. These Second Life user-interlocutors are logged in from all over the world, but use English as a medium of communication. This practicum provides authentic interactions for task achievement.

In three tests at a graduate institute in Japan, SVECTAT was found to achieve the same level of language learning in half the instructional time compared with individual role-play of the same tasks with a model speaker (Cook et al., 2010; Elwell et al., 2009). Learners mentioned in particular the value of being able to take what they had learned in the classroom and immediately apply it in the “real world” (See Figure 1). This was observed as a “flow” experience (Czikszentmihalyi, 1990).

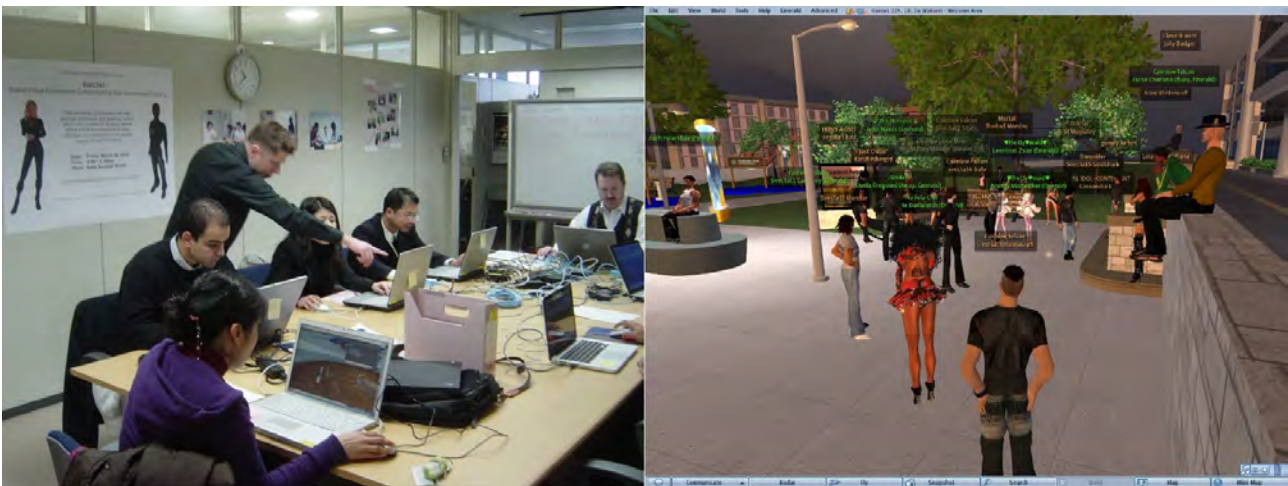

Figure 1. SVECTAT session in physical and virtual environments

3. Experiment

We held two parallel experimental sessions, one in Japan and one in Taiwan, in April 2014. Twelve master's students participated in each location, all learners of English as a foreign language. The Japan session was led by model speakers experienced with SVECTAT; the Taiwan facilitators was led by researchers and graduate students, including a model speaker, all new to using SVECTAT.

Each three-hour session began with an introduction of the learning activity by the instructors or facilitators and individual completion of two evaluation instruments by the subjects as a pre-test. One instrument was a multiple-choice test consisting of 10 communication tasks, for each of which the learners selected the most appropriate of 3 phrases to use. The other was a self-assessment on the same tasks, for each of which the learners selected “NA – not able”, “Competent”, “Confident”, or “Independent” as their own ability to achieve the task in an authentic interaction.

After the pre-tests, each session conducted modeling and practice with the full group of 12 learners. Instructors or facilitators modeled sample tasks and provided guidance and support for the learners to practice task achievement with one another.

Half of the total time of the sessions was used for the main exercise. Control groups continued to practice and discuss task achievement while leaving the classroom one by one to attempt individual task achievement with a model speaker. Experimental groups spent 1/3 of this time period becoming familiar with the use of Second Life, and the remainder engaging in interactions with other users to attempt task achievement.

The final period of the sessions focused on individual completion of the two evaluation instruments (multiple-choice and self-assessment) as a post-test.

The arrangement and flow of the experimental sessions is shown in Table 1.

Table 1: Experimental Flow

30 minutes	<ul style="list-style-type: none"> •introduction •pre-tests •demonstration <p style="text-align: center;">[all subjects]</p>	
30 minutes	<p>Guided and supported group task achievement practice</p> <p>[all subjects]</p>	
90 minutes	<p>Individual task achievement training (face to face with model speaker)</p> <p style="text-align: center;">[control group]</p>	<p>Individual task achievement training (in Second Life with authentic speakers)</p> <p style="text-align: center;">[experimental group]</p>
30 minutes	<ul style="list-style-type: none"> • post-tests • debriefing • discussion <p style="text-align: center;">[all subjects]</p>	

4. Results and Analysis

As seen in Table 2 below, all groups showed measurable improvement in performance on the multiple-choice test after the learning exercise. This experiment did not target what part of this improvement resulted from, e.g., classroom practice, individual task-achievement, or the opportunity for reflection in taking the test a second time.

Table 2: Multiple-Choice Test Scores

	Test Scores			
	Japan		Taiwan	
	Classroom	Second Life	Classroom	Second Life
Mean				
Pre-test	4.8	5.67	8.5	7
Post-test	6.67	6.3	9.67	8.5
Post - Pre	1.87	0.63	1.2	1.5

Of note is that both Taiwan groups scored significantly higher on both the pre-test and the post-test than the Japan groups. This raises the question of how much room for improvement existed, and therefore whether the method has similar value for learners of different prior ability. It also raises the question of whether learners' abilities and attitudes vary based on factors such as features of culture and education systems in difference countries.

As seen in Table 3, below, both groups in Japan showed clear improvement on the self-assessment after the learning exercise, while the groups in Taiwan showed minimal positive improvement (control) or actual negative improvement (experimental). This divergence will receive attention in the Discussion section.

Table 3: Self-Assessment Results

	Communication Task Achievement Self-Assessment			
	Japan		Taiwan	
	Classroom	Second Life	Classroom	Second Life
Mean				
Pre-test	0.92	0.92	1.78	1.98
Post-test	1.46	1.63	1.87	1.75
Post - Pre	0.54	0.71	0.09	-0.23

Note: We did not receive two participants' self-assessments from the Taiwan experimental group; data for that group is therefore based on four participants.

5. Discussion

5.1 Bases and Questions for Discussion

We base our discussion on the logistics of the sessions, the results of the multiple-choice tests and self-assessments, and the observations and opinions of the instructors and facilitators, as obtained through interviews using a questionnaire. From these, we derived three differences requiring attention:

- Subjects in Taiwan scored and self-assessed higher than subjects in Japan
- Subjects in Japan but not in Taiwan showed significant self-assessed improvement
- Conduct of the two sessions had differences related to instructor and facilitator experience

Note: instructors and facilitators are identified by location and number, e.g., JI2 and TF4.

5.2 Country-based Gap in English Ability

Subjects in Taiwan scored and self-assessed higher than subjects in Japan. In the multiple-choice pre-test, the subjects in Japan had a mean score of 5.23, while those in Taiwan had a mean score of 7.75, a difference of 2.52 out of 10; in the multiple-choice post-test, the difference was 2.6. In the self-assessments, the differences were 0.96 in the pre-test, and 0.27 in the post-test.

While both country groups were composed of master's students, the institution in Japan was a science and technology research institute, while the one in Taiwan was an education university. In Japan, students in science and mathematics tracks and schools at the high school level and beyond receive significantly less English instruction than those studying humanities. This tends to compound the already serious gap between Japan and other Asian countries in performance on tests such as TOEFL and the SAT. It seems likely that this contributed to the country-based gap in scores and self-assessments.

All the facilitators in the Taiwan session agreed with the reported observation that the communication tasks were too easy for the students there, "because they were all master's students". This observation demonstrates the country-based language ability gap strongly. Whereas all the subjects in our study volunteered for a learning exercise held in English, a majority of master's students at the institution in Japan where the session was held would be unable to participate at all, for lack of ability to function in an English-language classroom, let alone an authentic English-language communication environment.

5.3 Country-based Gap in Improvement

Subjects in Japan showed significantly more improvement in their self-assessed ability to achieve the listed communication tasks after the learning exercise than subjects in Taiwan. The mean improvement of the subjects in Japan (control and experimental) was 0.625, whereas that of the subjects in Taiwan was actually negative, at -0.07. This result in particular raises questions about what sorts of learners and learning situations are suitable for SVECTAT.

The students in the control group in Taiwan were nervous about interacting with the facilitators (based on TF3's report). Conversely, in the Taiwan experimental group, students showed low anxiety and high enjoyment of participating in the activities (TF5, TF1, TF6). Overall, the instructors found the students in Japan to be nervous about communicating in English, though much more so face to face than using the shared virtual environment.

The experimental sessions, as in previous SVECTAT tests, worked better for introverts. As one of the facilitators mentioned, "Let's say for introverts, they don't want to show their faces. They don't want to talk face-to-face. They can do the typing." Since science and technology students in Japan are widely seen to tend to be introverts, this may also be relevant to the country-based gap in results.

5.4 Instructor and Facilitator Experience-based Differences

Much of the feedback and opinion in the instructor and facilitator interviews was related to the gap in experience with the SVECTAT method between the instructors in Japan and the facilitators in Taiwan, and its possible influence on the learning experience and the experimental session results.

The instructors in Japan, experienced English language teachers, had conducted exercises and controlled experimental sessions with SVECTAT three times before. In addition, they were the original developers of the method. Conversely, the facilitators in Taiwan, researchers and graduate students, had received explanations and guidance related to SVECTAT and to the planned experimental session only in two online meetings, and had not themselves experienced a SVECTAT activity either as facilitator or learner.

All the facilitators in the Taiwan control group (TF2, TF3, TF4) consistently reported that the participants were nervous during the activities because they (the participants) were not clear about what they needed to do and what their final goal in the activity was. These facilitators, and those in the experimental group (TF5, TF1, TF6) all further reported that they themselves did not have a clear picture of their role and tasks before conducting the experiment. In the Japan session, the instructors and participants found no such difficulties.

6. Conclusion

We tested the feasibility, applicability, and effectiveness of Shared Virtual Environment Complementing Task Achievement Training (SVECTAT) for task-based language learning. We conducted parallel experimental sessions in two different countries, carried out by different teams of facilitators, with graduate students learning English as a foreign language.

We found significant differences in the results in the two sessions. Subjects in Taiwan scored and self-assessed higher than subjects in Japan, showing a gap in English language education and cultural attitudes toward English language learning. Subjects in Japan but not in Taiwan showed significant self-assessed improvement, likely due to differences in the conduct of the two sessions related to instructor and facilitator experience, and simply to greater room for improvement.

This test has shown us that, while the SVECTAT method can be effectively tested and used in different countries and with different teams of facilitators, care and affordances are required to ensure results that will justify its use, both for learners and for facilitators. Specifically, attention must be paid to the starting abilities of the intended learners, and both written materials and experiential training need to be provided to prospective facilitators; further, assessment and feedback methods must include open-ended, reflective instruments for both learners and facilitators. We consider these to be indications for future work in research and development of SVECTAT.

References

- Cook, S., Elwell, M. & Leigh, M. (2010). Classroom Learning, Virtual World Application - Developing the SVECTAT Method. In Joint Proceedings of the Work-in-Progress Poster and Invited Young Researcher Symposium at the 18th International Conference on Computers in Education.
- Csikszentmihalyi, M. (1990). *Flow: The Psychology of Optimal Experience*. New York: Harper and Row. ISBN 0-06-092043-2.
- Ellis, Rod (2003). *Task-based Language Learning and Teaching*. Oxford, New York: Oxford Applied Linguistics. ISBN 0-19-442159-7.
- Elwell, M., Cook, S., Leigh, M., & Terrillon, J. C. (2009). Shared Virtual Environment Complementing Task Achievement Training. In Proceedings of the 17th International Conference on Computers in Education, Hong Kong.
- Elwell, M., Cook, S., Leigh, M., & Elwell, M. (2010). Around the Worlds-Testing the SVECTAT Method. In Workshop Proceedings of the 18th International Conference on Computers in Education: ICCE2010.
- Lan, Y. J. (2014). Does Second Life improve Mandarin learning by overseas Chinese students? *Language Learning & Technology*, 18(2), 36–56.
- Lan, Y.-J., Kan, Y.-H., Hsiao, I. Y. T., Yang, S. J. H., & Chang, K.-E. (2013). Designing interaction tasks in Second Life for Chinese as a foreign language learners: A preliminary exploration. *Australasian Journal of Educational Technology*, 29(2), 184-202.
- Prabhu, N. S. (1987). *Second Language Pedagogy*. Oxford: Oxford University Press.

Situational Sets Effect on Role-Play Game Supported English for Specific Purposes Vocabulary Acquisition

Fang-Chen LU^{a*}, Ben CHANG^a

^a*Graduate Institute of Learning and Instruction, National Central University, Taiwan*

*100187002@cc.ncu.edu.tw

Abstract: The purpose of this study is to examine the effectiveness of using the Facebook online game, *ChefVille*, as an English learning tool to facilitate English for Specific Purpose (ESP) vocabulary acquisition. In addition, students' learning motivation toward the Facebook online game, *ChefVille* was studied. This game used situational sets in a role-play game (RPG) learning environment as ways of bringing words together so that students related words to the central concept. The instruments used include a questionnaire, and two vocabulary tests. The results confirmed that incorporating an online RPG-based method facilitated students' ESP vocabulary acquisition. It was also revealed that an online RPG-based learning method is effective in promoting motivation and changing attitudes toward vocabulary learning. The results derived from the experiment led to the conclusion that applying an online RPG-based learning strategy into ESP vocabulary learning can yield positive learning effect for the learners.

Keywords: RPG, situational sets, ESP, vocabulary acquisition

1. Introduction

With the rapid development of business communities around the world, English language skills have been considered an important tool needed to compete in the global economy. One of the goals of foreign language education identified by the Ministry of Education of Taiwan for vocational educational programs is to provide students with the foreign language ability and advanced professional knowledge necessary to succeed in the job market. This development trend has caused ESP instruction to be more greatly emphasized for the last few years at vocational schools in Taiwan (Johns & Dudley-Evans, 1991).

ESP is well known as a learner-centered and content-based approach to teaching English as a foreign language, which meets the needs of learners who need to learn English for use in their specific fields, such as business, science, technology, or academic learning. However, there are some problems in the development of ESP courses in Taiwan. Porcaro (2001) indicated that authentic materials and specific knowledge were not provided in ESP courses. Considering the problems for ESP development in Taiwan mentioned above, the aim of this study is first, to check if students acquire more ESP vocabulary using situational sets in an RPG learning environment, and second, to seek students' motivation toward the Facebook online game "*ChefVille*" as a tool to facilitate ESP vocabulary learning.

2. Related Work

By definition, English for Specific Purpose (ESP) is designed to meet specific needs of the learner (Dudley-Evans & St. John, 1998). ESP has some distinctive features with special attention to authenticity. Nunan and Miller (1995) define authentic materials as those which “were not created or edited expressly for language learners. Authentic materials illustrate how English is used naturally by native speakers.” One of the most challenging tasks constantly facing ESP teachers is how to bring authentic materials into the classroom. With the advantage of RPG-based learning environment, students are able to develop their own strategies for dealing with real language and stimulate their motivation to learn.

Role-play games (RPGs), in which students are encouraged to come across different authentic materials related to their study subject, are highly graphical 2D or 3D video games played online allowing individuals to interact not only with the gaming software but also with the avatars of other players through their self-created digital avatars (Steinkuehler, 2003). Moreover, virtual learning in RPG environment provides a space for constructive learning and immerses learners in a meaningful communication simulated to authentic practices (Chuang, Chang & Chen, 2014). It is recommended that RPG be implemented in the contexts where students need to learn the knowledge and skills of English and practice them in authentic ways as they provide active interactions and collaborations among learners as well as address cognitive issues and foster active learning (Yip & Kwan, 2006).

Moreover, situational sets in vocabulary learning require the use of “general concepts” to bring together the specifics. It refers to the “cohesive chains” of relationships between words in a discourse. The technique stresses the need for using the context or situation in which words appear as an organizing principle. For example, cluster words such as *reservation*, *grilled salmon*, *salad dressing*, *appetite*, and *slow service* are revolved around the central concept *customer* in restaurant setting. The examples of situational sets were presented as the following (as shown in Figure 1).

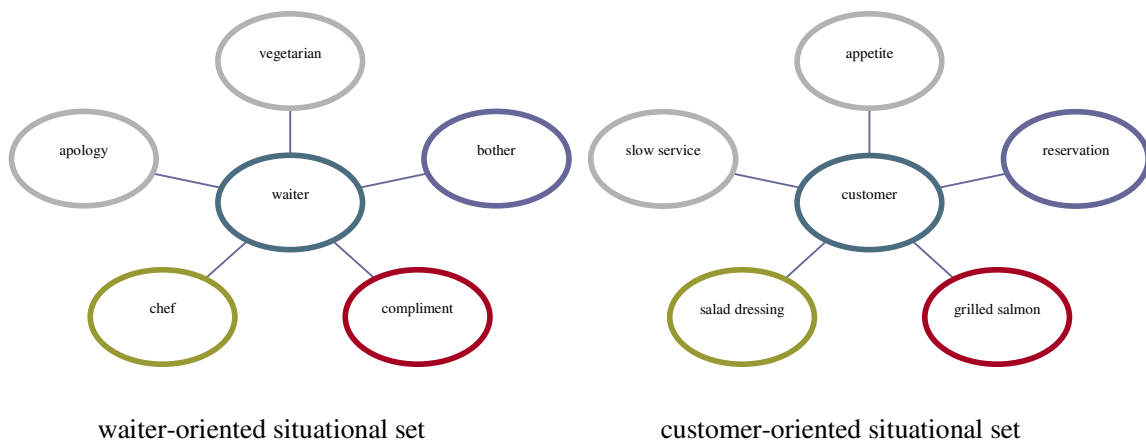

Figure 1. Examples for situational sets

3. Method

3.1 Research Design

The study was designed to answer the two following research questions: 1) Do students actually acquire more ESP vocabulary using situational sets in an RPG learning environment? and 2) What are students' motivation toward the Facebook online game "ChefVille" as a tool to facilitate ESP vocabulary learning? We investigated the first question by constructing and administering a special self-designed vocabulary test. Secondly, we investigated the second question via framing and implementing a self-designed questionnaire.

3.2 Procedure and Instruments

"ChefVille" is one of the English version games from Facebook. There were forty participants (experimental group) were assigned to engage in the learning environment compared to the other forty participants (traditional teacher-directed instruction). This game is not embedded in the learning class; it means that participants would utilize the game, as an English learning tool anytime and anywhere they like. The experimental sequence of the study took approximately twenty hours spread over one month. The game is regarded as participants' additional English learning tool; therefore, they are expected to learn with no stress and are supposed to learn autonomously and acquire vocabulary spontaneously. Therefore, there is no strict time restriction; participants can decide how many days and for how long they would like to spend their time playing the game, but they must use it at least four hours a week. "ChefVille" lets users run their own restaurant, do the shopping, enquiry and purchase, make dishes, and serve the dishes to build up their unique restaurants (as shown in Figure 2). In addition, it may be a feasibly situated learning environment for problems solving and tasks completion in order to achieve a goal (as shown in Figure 3)



Figure 2. Authentic task-based scenario in the game



Figure 3. Goal-based interaction for situated learning in the game

The instruments used consisted of two sections. Section 1 aimed to estimate participants' current English vocabulary size in order to do a comparison with the vocabulary acquisition

achievement after the learning environment. The vocabulary tests were administered as the pre-test, the immediate post-test, and the delayed post-test. The content of testing items were the same, but the sequence of the items was dissimilar. Example for the testing items was presented as bellows (as shown in Table 1).

The participants had 50 minutes to finish the vocabulary test divided into two parts. The first part of the test was a recognition test containing ten items of matching English vocabulary with Chinese in a traditional vocabulary recognition test form. The second part of the test contained ten questions testing sentence comprehension and vocabulary, which are randomly chosen from *ChefVille*'s daily questions. The test design aimed to provide learners with the closest simulation of the game's format with the concern of decreasing test-takers' anxiety in order to assess their authentic performance. The total points of the test were 50 each.

Table 1: Example for vocabulary test items.

<p>Part 1: Matching English vocabulary with Chinese</p> <p>Examples:</p> <p>1. () (1)vegetarian () (2)bartender () (3)appetite () (4)chef () (5)cashier (A)主廚 (B)食慾；胃口 (C)出納(員) (D)素食者；素食的 (E)酒保</p> <p>Total: 50 points (5 points for each item)</p>	<p>Part 2: Please choose the right answer</p> <p>Examples:</p> <p>1. () Which of the following is not found in basic mayonnaise? a) egg b) oil c) milk</p> <p>2. () Which ingredient is not present in Pat's inventory? a) wheat bread b)lettuce c) milk</p> <p>Total: 50 points (5 points for each item)</p>
---	--

In Section 2, in an attempt to obtain participants' motivation and vocabulary learning effectiveness, the questionnaire distributed to explore the participants' learning motivation of toward the Facebook online game "*ChefVille*" as a vocabulary learning tool over an extended period of time, revealing their learning situation as well as personally significant transformations.

The questionnaire classifies the features of motivation toward the Facebook online game "*ChefVille*" as a tool to facilitate ESP vocabulary learning into the following five factors: personal interest, external expectations, learning achievement, social contact and social stimulation.

4. Discussion and Conclusion

This study investigated the effectiveness of using the Facebook online game, *ChefVille*, as a learning tool to facilitate ESP vocabulary acquisition, and students' motivation of English learning using *ChefVille*. In accordance with the results and discussion, several major conclusions are made.

First of all, the results indicated that situational sets with RPG support are beneficial to students' ESP vocabulary acquisition. According to the finding of the study, the experimental group (RPG-enhanced instruction) reached higher scores than the control group (teacher-directed instruction). Much difference was found in two vocabulary test scores across the two learning conditions. In terms of motivation, the students scored highest on the scale of "Social Stimulation" followed by the "Social Contact", indicating that the sociocultural approaches linking to students' daily life experiences might be able to foster students' motivation toward situational sets with RPG support learning. The use of online RPG-based learning environment can promote students' willingness to learn. Most of the students possess good attitudes and hold positive perspectives toward online RPG-based English learning. Some of the limitations of this study could serve as future directions for conducting related studies. The newly developed Motivation toward RPG Situational Sets Learning Survey should be validated with a larger sample across different grade-levels and with a more rigorous method such as confirmatory factor analysis. Moreover, as previously mentioned, researchers can adopt qualitative or mixed methodologies to explore students' motivation toward situational sets with RPG support learning from different perspectives and identify additional scales.

References

- Chuang, M. T., Chang, B. & Chen, H. C. (2014). Investigating reported social and affective strategy use by EFL learners in virtual and real learning environments. *International Journal of Applied Linguistics & English Literature*, 3(2), 27-33.
- Dudley-Evans, T., & St. John, M. (1998). *Developments in English for specific purposes: A multi-disciplinary approach*. Cambridge: Cambridge University Press.
- Johns, A., & Dudley-Evans, T. (1991). English for specific purposes: international in scope, specific in purpose. *TESOL Quarterly*, 25, 297-314.
- Nunan, D., & Miller, L. (1995). *New ways in teaching listening*. Alexandria, VA: TESOL.
- Porcaro, J. W. (2001). Integrating authentic materials and language skills in English for science and technology instruction. *In English Teaching Forum On-line Journal*, 39(2), 30.
- Steinkuehler C. (2003). *Massively multiplayer online videogames as a constellation of literacy practices*. Paper presented at the International Conference on Literacy, Ghent, Belgium.
- Yip F.W. & Kwan A.C. (2006) Online vocabulary games as a tool for teaching and learning English vocabulary. *Educational Media International* 43, 233–249.

Understanding English Language Learners' Experiences and Perceptions of Mobile Assisted Vocabulary Learning

Lu-Yu YEH^a, Hsiu-Ting HUNG^{b*}, Janice LIAO^c

^a *National Kaohsiung First University of Science and Technology, Taiwan*

^b *National Kaohsiung First University of Science and Technology, Taiwan*

^c *National Yunlin University of Science and Technology, Taiwan*

*hhung@nkfust.edu.tw

Abstract: Grounded in the field of Mobile Assisted Language Learning (MALL), this study aimed to explore students' experiences of using a vocabulary learning application as a self-study tool, and to understand their perceptions of the related learning experiences. With Taiwanese English-as-a-Foreign-Language (EFL) learners from a university as participants, the students were instructed to use the application via smartphones or tablet PCs to learn vocabulary for five weeks. During the intervention, the collected data included: self-reported learning logs, technology acceptance questionnaires, and semi-structured individual interviews. The findings revealed that both the tablet PC and the smartphone groups favored the vocabulary learning application, and their user experiences as well as perceptions yielded similar positive results, regardless of the mobile device utilized.

Keywords: Mobile Assisted Language Learning (MALL), vocabulary learning, English as a Foreign Language (EFL)

1. Introduction

Mobile Assisted Language Learning (MALL) is developing into a sub-field of Computer Assisted Language Learning (CALL), given the growing use of mobile technology for learning in recent years. Pioneering MALL studies focus on the use of early mobile devices, such as PDAs (Song & Fox, 2008) and cell phones (Stockwell, 2007; 2008; 2010). In these studies, mobile devices are criticized for posing challenges to learning because "inherent in the portability of mobile media are reduced screen sizes, limited audiovisual quality, virtual keyboarding and one-finger data entry, and limited power" (Chinnery, 2006, p. 13).

Current mobile devices, however, have much larger screens with higher resolutions, and allow learners to download a variety of applications (or apps) that can be used to learn foreign languages. With the rise of mobile technological advancement, limited research has been conducted on the potential of the latest mobile devices for language learning. The main type of mobile learning apps used in early MALL studies center on vocabulary learning, since these are easily accessible to most researchers who do not have the resources or abilities required to develop custom apps to suit their specific purposes. Due to limitations and earlier criticisms of previous MALL research, this study aims to fill the research gap by comparing the effectiveness of the new generation of mobile devices (i.e., smartphones and tablet PCs) on language learning. Therefore, this study also focuses on the use of a vocabulary learning app, EngKing, that is available for free via smartphones or tablet PCs.

The purpose of the study was to explore English-as-a-foreign-language (EFL) learners' experiences and perceptions of mobile assisted vocabulary learning. The following three research questions are addressed in this study: 1) What were the students' experiences of using the vocabulary learning app as a self-study tool, in terms of frequency of use and difficulty of use? 2) What were the

students' perceptions of using the vocabulary learning app as a self-study tool, in terms of perceived usefulness, perceived ease-of-use, and behavioral intention of use? 3) Did the students' overall experiences and perceptions of mobile assisted vocabulary learning vary significantly based on different mobile devices used?

2. Methodology

2.1 Setting

The research site was a content-based course at a public university in Taiwan. The title of the course is Science, Technology, and Society (STS), and its main objectives were to enhance students' understanding of STS issues in society, while improving their English vocabulary knowledge. In total, 50 students enrolled in this two-credit course in 2012, but only 21 students were recruited to voluntarily participate in the study, due to the limited availability of the mobile devices required for this study. All the participants were English majors with an intermediate proficiency level. The participants were aged from 20 to 21 years old, and only four of them were male.

2.2 Participants

Based on the purpose of the study, the participants were further divided into two groups: a tablet PC group and a smartphone group. The mobile devices for the tablet PC group were loaned to the 12 participants by the instructor for the duration of the study. By contrast, the 9 participants in the smartphone group used their own devices.

2.3 Research Design

Since EngKing is primarily designed to assist English language learners in vocabulary drills and practice, this app was deemed appropriate as a self-directed mobile learning tool for the purpose of this study. In the research design, both the tablet PC and the smartphone groups were directed to create their own personalized vocabulary notebooks based on the lessons in the STS course. Within the notebook, each word was added alongside its English definition, Chinese meaning, part of speech, and sample sentences. After the participants had customized their notebooks, EngKing could then be used to take personalized quizzes or tests in the following formats: 1) word definition test, 2) word definition and pronunciation test without clues, 3) word definition and pronunciation test with clues, 4) pronunciation test, and 5) spelling test. Each vocabulary quiz was based on at least 20 random words generated from the participants' personalized vocabulary notebooks. Thus, this self-testing feature of EngKing allowed the participants to practice according to their own needs.

2.4 Procedure

The procedure of this study lasted for a total of eight weeks. In week 1, both the tablet PC and the smartphone groups were required to attend a training session on EngKing. In weeks 2 to 6, all the participants were asked to use EngKing as a self-study tool out of class by creating their personalized vocabulary notebooks and utilizing the self-testing feature of the app to review the course content. As a way to monitor their self-study progress during this period, all participants were instructed to record in their learning logs that were collected on a weekly basis for a duration of five weeks. In weeks 7 and 8, a five-Likert scale technology acceptance questionnaire and a series of semi-structured individual interviews were used to gather the students' opinions. The questionnaires were administered to all the 21 participants, and a total of 8 participants voluntarily participated in the interviews. In brief, the collected data for this study included: learning logs, technology acceptance questionnaires, and individual interviews. The results derived from the descriptive statistical analysis and content analysis were used to answer the three research questions, which are presented in the following section.

3. Findings

3.1 *Students' Experiences of Using the Vocabulary Learning App*

The first research question examined the students' experiences of using the app as a self-study tool, in terms of frequency of use and difficulty of use. An analysis of the learning logs showed that the smartphone group used the app for slightly more time than the tablet PC group (at an average of 9 and 8.7 hours per week, respectively). The higher frequency of app usage may be attributed to the fact that the students used their own smartphones, which they always carried, and thus were more accessible to them for mobile learning. However, the tablet PC group inputted more words per week than the smartphone one, at an average of 32 words compared to 22. This may be explained, in part, by the observation that data entry on smartphones is comparatively more cumbersome. As for self-study with vocabulary drills on EngKing, both groups had the same frequency, with a mean of 14 times per week.

The participants' opinions regarding their difficulties when using EngKing to learn vocabulary were collected in the individual interviews. While the majority of interviewed students had positive attitudes toward EngKing, some stated that they encountered difficulties for the following reasons: 1) It was difficult to enter words using the small virtual keyboards on the mobile devices, especially with the smartphones. 2) This app did not check the students' spelling in their personalized vocabulary notebooks, and thus there was a higher possibility that they would learn the incorrectly spelled words rather than the words they initially had in mind. 3) Other entertaining apps, and even the Internet itself, would distract the students' attention when they tried to learn vocabulary using a mobile device.

3.2 *Students' Perceptions of Using the Vocabulary Learning App*

The second research question explored the students' perceptions of using the app as a self-study tool, based on Davis' (1989) Technology Acceptance Model (TAM), which entails three major concepts of perceived usefulness, perceived ease-of-use, and behavioral intention to use. The findings were derived from the five-Likert scale technology acceptance questionnaire administered at the end of the intervention (5= strongly agree; 4= agree; 3= neutral; 2= disagree; 1= strongly disagree). The responses of "strongly agree" and "agree" were combined and reported as agreements, and responses of "disagree" and "strongly disagree" were treated as disagreements in the following report.

Based on the results of the perceived usefulness subscale, 34% of the students agreed with the survey statement "I think using mobile based application would improve my performance in this course", while 57% agreed with the statement "I think using the app was useful to enhance my vocabulary learning", and 43% concurred that "I could conduct more vocabulary learning activities using the app than would otherwise be possible." Overall, approximately half of the participants had positive attitudes towards the usefulness of the app, while some of them remained neutral, and only a small percentage of them had negative feedback.

According to the results of the perceived ease-of-use subscale, 62% of the students agreed with the survey statement "I think the app was easy to use", while 29% agreed with the statement "I think using the app for vocabulary learning did not require much mental effort", and 57% concurred the statement "I think it was easy for me to learn how to use the app and use it skillfully." Overall, nearly half of the participants felt that the app was easy to use, while some of them held neutral attitudes, and only a small percentage of students felt it was difficult.

In terms of the subscale of behavioral intention to use, 53% of the students agreed with the survey statement "I intend to continue using the app in the future if it is made available to me", while 48% agreed with the statement "I intend to use the app for vocabulary learning as often as needed if it is made available to me", and 67% concurred with the statement "I would like to use the app in other courses if it is made available to me." Overall, a sizeable proportion of the students expressed a positive intention towards learning vocabulary using EngKing, and this result was more than double the number of those who expressed a negative intention.

3.3 Group Differences Based on the Different Mobile Devices Used

The third research question investigated whether group differences existed based on the different mobile devices used. In terms of the overall perceptions of mobile assisted vocabulary learning, a generally positive response was found from both groups. For the statement, “In general, I think learning English vocabulary through mobile technology is a wise idea”, 77% of the participants from the smartphone group agreed with this statement, as did 67% of the tablet PC group. When comparing the two groups’ differences with regard to the three major TAM concepts or subscales, the statistical results showed that the students’ overall experiences and perceptions of mobile assisted language learning did not vary significantly based on different mobile devices used. Nevertheless, the smartphone group had slightly higher scores in the three subscales of technology acceptance questionnaire, compared to the PC group.

4. Discussion

Previous research indicated that the small size of the screens and keypads on mobile devices are major barriers to the user acceptance of apps on such technologies (Chinnery, 2006). However, the finding of this study revealed that the students’ perceptions of mobile assisted vocabulary learning were actually better when using a smartphone rather than a tablet PC, although the differences were not significant. This finding is somewhat at odds with Stockwell (2007; 2008; 2010), as these earlier MALL studies found that higher scores were obtained when using a desktop computer compared with a mobile phone, and that the smaller screen and keypad with the latter were the main reasons for this. One possible reason is due to the advancement in smartphone technology that has taken place in recent years with regard to screen display and keypads. Another reason is that the smartphone group in the current study used their own mobile devices for learning, and thus the ownership and familiarity are possible factors that resulted in the higher self-efficacy among these users.

Furthermore, the finding that using mobile devices to learn vocabulary led to positive attitudes toward such learning is consistent with Jones, Scanlon, and Cloughs (2012), which showed that mobile devices provide both autonomy for self-directed learning and mobility in the learning process, offering a greater degree of freedom with regard to when and where one studies. In the current study, the majority of the participants noted the facilitative use of mobile technology in promoting their vocabulary learning, as it was able to enhance their learning interest by providing timely information whenever needed. Such devices can provide a learning environment that is more student-centered, without the need for scaffolding or facilitation from a real-life teacher (Facer, Joiner, Stanton, Reid, Hull & Kirk, 2004).

Despite their positive attitudes, the participants also noted some difficulties, such as inconvenience when inputting words, the lack of a spell-check function, and environmental distractions when using mobile devices to study. The first of these confirms one research finding by Gikas and Grants (2013), whose study indicated how virtual keyboards on small screens are difficult and frustrating to type. Moreover, many of the participants in the current study stated that they spent too much time creating their personalized vocabulary notebooks on the small or virtual keyboards without a spell-checker. Since the students were not provided with a vocabulary list by the instructor to serve as an integral part of the in-class materials, they had to rely on their English proficiency skills to find vocabulary items, thus requiring more time and mental effort. This study also found that distractions on mobile devices or from the environment are a potential threat to learners’ concentration, as also noted in Thornton and Housers (2005) and Stockwell (2007). Many of the participants in this study reported that while they usually carried their mobile devices with them everywhere, they did not use them for studying until they found a quiet environment, which enabled them to stay focused and avoid distractions.

5. Conclusion

This study demonstrated that smartphones and tablet PCs have the potential to enable and enrich mobile learning. It can thus be argued that learning vocabulary via mobile technology can be

beneficial for learners by providing them with more exposure and opportunities to learn, whenever and wherever they want to. However, this study is limited in generalizability due to the small number of participants, based on the availability of tablet PCs. This study also used convenience sampling, which may have introduced some potential biases, as all the participants were selected from one available intact class, without any criteria based on proficiency levels, gender, and age. Future research may recruit more participants with a larger range of diverse backgrounds. For example, Wang, Wu, and Wang (2009) found that user acceptance of mobile learning could vary due to age and gender, and these factors may be investigated in future MALL studies.

Acknowledgement

This paper was supported by the National Science Council of Taiwan under the grant NSC 100-2511-S-327-001.

References

- Chinnery, G. M. (2006). Going to the mall: Mobile assisted language learning. *Language Learning & Technology, 10*(1), 9–16.
- Davis, F. D. (1989). Perceived usefulness, perceived ease of use, and user acceptance of information technology. *MIS Quarterly, 13*(3), 319–339.
- Facer, K., Joiner, R., Stanton, D., Reid, J., Hull, R., & Kirk, D. (2004). Savannah: mobile gaming and learning? *Journal of Computer Assisted Learning, 20*(6), 399–409.
- Gikas, J., & Grant, M. M. (2013). Mobile computing devices in higher education: Student perspectives on learning with cell phones, smartphones and social media. *The Internet and Higher Education, 19*(1), 18–26.
- Jones, A. C., Scanlon, E., & Clough, G. (2012). Mobile learning: Two case studies of supporting inquiry learning in informal and semiformal settings. *Computers & Education, 61*(1), 21–32.
- Song, Y., & Fox, R. (2008). Using PDA for undergraduate student incidental vocabulary testing. *ReCALL, 20*(3), 290–314.
- Stockwell, G. (2007). Vocabulary on the move: Investigating an intelligent mobile phone-based vocabulary tutor. *Computer Assisted Language Learning, 20*(4), 365–383.
- Stockwell, G. (2008). Investigating learner preparedness for and usage patterns of mobile learning. *ReCALL, 20*(3), 253–270.
- Stockwell, G. (2010). Using mobile phones for vocabulary activities: Examining the effect of the platform. *Language Learning & Technology, 14*(2), 95–110.
- Thornton, P., & Houser, C. (2005). Using mobile phones in English education in Japan. *Journal of Computer Assisted Learning, 21*(3), 217–228.
- Wang, Y. S., Wu, M. C., & Wang, H. Y. (2009). Investigating the determinants and age and gender differences in the acceptance of mobile learning. *British Journal of Educational Technology, 40*(1), 92–118.

Using an online social network site as a learning community to enhance EFL learners' cultural awareness

Ming-Yi CHEN HSIEH^{a*}, Wen-Chi Vivian WU^b, Yu-Chuan Joni CHAO^c, & Chun-Lan CHEN^d

^a*Department of Foreign Languages and Literature, Tunghai University, Taiwan*

^{bcd}*Department of English Language, Literature, and Linguistics, Providence University, Taiwan*

*curtis3883@gmail.com

Abstract:

EFL students suffer from low awareness of the target culture and low actual intercultural communicative competence due to an insufficient input and decontextualized learning environment; the current study, therefore, aimed to use Internet social networking, specifically Facebook, as a learning community framework to enhance EFL students' cultural awareness via cross-cultural interaction with American e-pals. The participants were 15 English majored students in Taiwan and 20 undergraduate students in the U.S. The participants were asked to engage in cross-cultural communication on chosen topics (self-introduction, school life, and Taiwanese night markets or American county fairs) with the American students. A mixed method of qualitative and quantitative research was employed to analyze the data. While qualitative data included focus group interviews and reflective papers, quantitative data consisted of evaluation of the students' cultural awareness. The major findings were: (1) Students demonstrated a moderate level of cultural awareness, (2) Using Facebook helped students to overcome the differences in time zones, to gain in cultural awareness, to clarify stereotypes, and to recognize their improvements, (3) Students found benefits in the comfortable learning environment, including classroom atmosphere, cultural awareness, authentic readers, writing skills, motivation, and autonomous learning. In conclusion, the results revealed the merits of creating an online learning community for EFL students. In addition, the framework of the instructional design provides researchers and instructors with directions to enhance the cultural awareness of students in an English writing class.

Keywords: online learning community, cultural awareness, critical thinking

1. Introduction

Language and culture seem inseparable as language is the expression of ones' cultural background. The literature is replete with statements that students' cultural awareness facilitated the learning of a target language as students used their cultural knowledge to comprehend the sentences in an authentic learning context, as documented in Heidari, Ketabi, & Zonoobi (2014), Mitchell & Myles (2004), and Papademetre & Scarino (2006). Through the interaction, students compared and contrasted the cultural similarities and differences to achieve cultural reflection, allowing them to understand the viewpoints of the native speakers. Previous studies have indicated a close relationship between critical thinking and cultural awareness (Ingulsrud et al., 2002; Lee, 2011; McAllister et al., 2006; O'Dowd & Eberbach, 2004). To better understand the messages they received from the people in other countries, people applied critical thinking skills to achieve cultural reflection (Ingulsrud et al., 2002; Lee, 2011). Students needed the critical thinking skills, including analyzing, interpreting, and evaluating, to understand the messages of people from other countries. The critical process helped students to understand the viewpoints of others (Hanvey, 1976; Deardorff, 2006).

While some studies have focused on the use of critical thinking to clarify student misunderstandings and cultural stereotypes related to the target language (Schwartz, Lin, & Holmes, 2003; Tsai, 2011), other researchers (Deardorff, 2011; Lee, 2012; Wu, Marek, & Chen, 2013; Ziegahn, 2005) have focused on applying critical thinking to improving the cultural awareness of students with respect to cultural differences and cultural backgrounds. Among tools that facilitate student critical thinking, social

network sites, particularly Facebook, provide students an authentic context to interact with people from other countries. Through the interactive process, EFL student can analyze a conversation, comprehend the main idea of an e-pal, and accept the different cultures, as well as reflecting upon and examining their own perceptions. Students develop critical thinking skills in the process of analyzing the ideas they receive from their peers (Shih, 2011; Wass, Harland, & Mercer, 2011).

Previous research that emphasized the use of the social network site as a communicative tool to connect students with e-pals from other countries has attempted to promote the learners' intercultural communication and cultural awareness (O'Connor, 2012; Wang, 2011). The results have shown that the students' knowledge grows as the result of the interaction with native speakers via social network sites (Grosbeck, 2009). Through sharing of information or articles, students can not only better understand each other's cultural backgrounds but also learn from the communication, including comprehending and comparing the differences between the mother language and the target language. Asynchronous online discussion on Facebook allows students to leave messages offline and to reply to the messages anytime and anywhere. The platform not only provides students with opportunities to connect with international friends and to share messages and files but also creates a learning environment which expands the students' ability to identify the similarities and differences between cultures (Commander, Zhao, Gallagher, & You, 2012; Liaw & Johnson, 2001; Wang, 2011; Wang, 2012). After receiving the cultural knowledge, students compare the cultural similarities and differences. Moreover, students reflect on their previous knowledge to consider whether they had some misunderstanding about the culture of the target language (Itakura, 2004).

The idea of establishing an online learning community via social media echoes the concept of Zone of Proximal Development (ZPD) and the theory of social constructivist learning (Vygotsky, 1978), as well as the theory of scaffolding (Wood, Bruner & Ross, 1976), all of which emphasize the importance of social interaction and indicate that knowledge and skills, such as cultural reflection and communicative competence, progress as a result of the interaction and help of capable peers. Knowledge is produced as the result of social interaction with others, as ideas are shared and explored, making social interaction a key to learning (Pritchard & Woollard, 2010).

The current study was designed to improve awareness of the target culture and enhance actual intercultural communicative competence of EFL students in Taiwan, who often suffer due to insufficient input and a decontextualized learning environment. The researchers used Internet social networking, specifically Facebook, as a learning community framework to enhance EFL students' cultural awareness via the cross-cultural interaction with American e-pals in an authentic context. The study particularly focused on two issues, (1) to what degree the students' cultural awareness improved, and (2) benefits resulting from using Facebook as a communication tool.

2. Methodology

2.1 Participants

The participants were 15 English majored students (two males and 13 females) taking an advanced EFL writing course at a four-year academic university in central Taiwan. The Taiwanese participants' writing proficiency was at the upper intermediate level because they had received training in writing for two years. The American e-pals (three males and 17 females) were undergraduate students in a multicultural communication class at a public Midwestern liberal arts college.

2.2 Instructional design

The students in the two classes were assigned to write three essays (a self-introduction, school life, and Taiwanese night markets or American county fairs) relating to their cultural and educational backgrounds, and to discuss their essays with their e-pals via private Facebook groups. The purpose of the topics was to encourage students to engage in more discussion with their e-pals, and to gain cultural awareness via the online social interaction. Facebook was integrated into this study to explore whether the students' cultural awareness, intercultural communication competence, and critical thinking skills were enhanced via the learning community.

Students discussed issues relating to their cultural background. To help their partners to comprehend cultural issues they express, students used the functions in Facebook, including sharing messages and uploading photos as well as videos, to assist in conveying meaning. At the end of the study, the Taiwanese participants were asked to write reflective papers addressing how their understanding of their e-pal's culture had changed. The students were asked to address five questions in their reflective papers. The questions asked about the students' understanding of cultural similarities and differences, reflections about misunderstanding of Western culture, perceptions of using Facebook as a communicative tool, as well as overall ideas about the cross-cultural communication. Two native English speakers were recruited to analyze the reflections using a critical thinking analysis framework developed by Wu, Marek, and Chen (2013), including cross-cultural recognition and reflection.

A mixed method of qualitative and quantitative research method was employed to analyze the data. While qualitative data included focus group interviews and reflective papers, quantitative data consisted of the evaluation of the students' cultural awareness.

3. Results and discussion

3.1 Cultural awareness in cross-cultural interaction

In terms of cultural awareness as the result of using an online cross-cultural learning community, the American reviewers and the researcher in this study evaluated the reflective papers of 15 students. All of the reflective papers were examined through critical text analysis. In the analysis, the students' cultural awareness (A) was determined by the number of cross-cultural recognitions (C) in which the students noted particular differences or similarities in two cultures), and reflections (R) in which the students compared and contrasted the recognized difference or similarity. Ideally, there would be one reflection for each recognition. The formula $A=R/C$ was applied to assess the students' level of cultural awareness.

The data for recognitions varied between three and 10, as evaluated by at least one of the reviewers. The data for reflections by individual students varied from one and six identified by the reviewers. The reviewers found an average of 6.53 recognitions in each paper and an average of 3.53 reflections per paper. Applying the $A=R/C$ formula, the researchers determined that the students averaged .56 reflections per recognition, defined as a cross-cultural critical thinking (A) value of 56 %, suggesting that the students in the current study performed critical thinking at a moderate level (see Table 1) and that students were not always able to compare and contrast the differences deeply even though they were aware of cultural differences.

Table 1: Evaluation of students' level of cultural awareness

Student	Reflection			Cross-cultural Recognition			Cultural Awareness
	Rater 1	Rater 2	Rater 3	Rater 1	Rater 2	Rater 3	
A	6	5	6	10	10	10	.56
B	4	6	4	6	4	6	.87
C	5	4	3	9	7	9	.48
D	3	4	4	5	6	4	.73
E	4	4	2	6	8	7	.47
F	3	2	1	6	5	4	.40
G	1	1	1	6	7	7	.15
H	4	5	5	6	7	5	.78
I	4	6	5	8	8	7	.65
J	5	3	4	8	8	7	.52
K	4	5	4	4	3	4	1.18
L	2	4	4	7	7	7	.47
M	1	1	1	3	5	3	.27
N	3	3	4	8	9	1	.37
O	2	4	3	7	6	5	.50
Mean		3.53			6.53		.56

The students' lack of ability in cross-cultural critical thinking is not surprising. This was the first experience for the Taiwanese students in a curriculum design intended to cultivate their critical thinking

skills, making it difficult to train the students to think critically in a short period of time. The typical learning environment in Taiwan does not teach or encourage critical thinking. In previous classes, the students in this study had most often received information from teachers and followed the guidance of their teachers, including detailed instructions about the content of compositions as well as the concepts behind the topic. The students' development of critical thinking, therefore, was inhibited by the learning environment of previous classes.

3.2 Benefits of using Facebook as a communicative platform

With regards to the benefits of using Facebook as a learning community platform for cross-cultural collaboration, students expressed their beliefs about the benefits of the powerful functions of Facebook. Using Facebook helped students to overcome the differences in time zones, to improve in cultural awareness, to clarify stereotypes, and to record their improvements. Using portable devices to connect to Facebook via the Internet enabled students to leave offline messages. Therefore, no matter what country the students were in, they replied and received the message at any time after connecting to the Internet. Moreover, the students found Facebook to be much more convenient than the older method of cross-cultural communication consisting of sending international letters.

Before having opportunities to interact with native speakers, students received their cultural knowledge from soap operas, movies, or books. This resulted in cultural stereotypes. On the other hand, when they had the opportunity to interact with native speakers, students received authentic information which clarified their misunderstandings. The Taiwanese participants also were pleased by their improvement in use of American slang. They thought that the most powerful function of Facebook is that it links friends together. Therefore, the opportunity to interact with native speakers meant that they could also read the messages which the e-pal exchanged with other American friends. In this way, they were able to examine and emulate the writing style and the vocabulary used by the native speakers in an authentic context.

Overall, as a platform for engaging in cross-cultural communication, students in this study perceived that Facebook overcame the problem of time differences between the two countries. Through uploading photos and videos, students comprehended the objects and activities which were described by their e-pals. Their cultural awareness was increased through the process. Furthermore, when communicating with the native speakers, the students were able to more deeply understand the culture and life and to learn from the slang which native speakers used while chatting with their e-pals. Also, students found that interacting with native speakers in an authentic environment caused them engage in self-reflection and to clarify misunderstandings. Overall, the students considered that interacting with native speakers through the social learning community was a positive experience.

4. Pedagogical implications and suggestions

The EFL teacher should help students to promote critical thinking in the context of reflection about culture. For instance, to enhance the students' critical thinking skills, teachers can require students to write a culture-related essay. Through this process, students will have the opportunity to compare and contrast the cultural similarities and differences. To guide students in their cultural reflection, teachers should use open-ended questions. After students achieve a deeper understanding of the culture of target language, the teacher can continue the activity and offer students opportunities to write a culture-related research paper which may also help students to understand the culture more deeply and to practice cultural critical thinking.

The EFL teacher should use social network sites to form learning communities for students to scaffold the abilities of each other. Given that EFL students in Taiwan have less opportunity to practice their writing abilities, online interaction on social network sites enable students to better understand the western culture.

Future studies could include the American students' opinions and reflections about the interaction. In-depth interviews with the American students could also be adopted so that their feedback provides additional insights into the effect of online social network use on EFL learners' cultural awareness.

References

- Commander, N. E., Zhao, Y., Gallagher, P. A. & You, Y. (2012). Promoting cross-cultural understanding of education through online discussions. *Procedia-Social and Behavioral Sciences*, 46, 4632-4642.
- Deardorff, D. K. (2006). Identification and assessment of intercultural competence as a student outcome of internationalization. *Journal of Studies in International Education*, 10(3), 241-266.
- Deardorff, D. K. (2011). Assessing intercultural competence. *New Directions for Institutional Research*, 2011(149), 65-79.
- Grosbeck, G. (2009). To use or not to use Web 2.0 in higher education. *Procedia Social and Behavioral Sciences*, 1, 478-482.
- Heidari, A., Ketabi, S. & Zonoobi, R. (2014). The role of culture through the eyes of different approaches to and methods of foreign language teaching. *Journal of Intercultural Communication*, 34, 6.
- Hanvey, R. G. (1976). *An attainable global perspective*. New York, N.Y: Global Perspectives in Education.
- Ingulsrud, J. E., Kai, K., Kadowaki, S., Kurobane, S. & Shiobara, M. (2002). The assessment of cross-cultural experience: Measuring awareness through critical text analysis. *Intercultural Journal of Intercultural Relations*, 26, 473-491.
- Itakura, H. (2004). Changing cultural stereotypes through e-mail assisted foreign language learning. *System*, 32, 37-51. doi:10.1016/j.system.2003.04.003.
- Lee, L. (2011). Focus on form through peer feedback in a Spanish-American telecollaborative exchange. *Language Awareness*, 20(4), 343-357.
- Lee, K. Y. (2012). Teaching intercultural English learning/teaching in world Englishes: Some classroom activities in South Korea. *English Teaching: Practice and Critique*, 11(4), 190-205.
- Liaw, M. L. & Johnson, R. J. (2001). E-mail writing as a cross-cultural learning experience. *System*, 29, 235-251.
- McAllister, L., Whiteford, G., Hill, B., Thomas, N. & Fitzgerald, M. (2006). Reflection in intercultural learning: Examining the international experience through a critical incident approach. *Reflective Practice*, 7(3), 367-381.
- Mitchell, R., & Myles, F. (2004). *Second language learning theories* (2nd ed.). London: Arnold.
- O'Connor, A. (2012). Beyond the four walls: Community-based learning and languages. *The Language Learning Journal*, 40(3), 307-320.
- O'Dowd, R. & Eberbach, K. (2004). Guides on the side? Tasks and challenges for teachers in telecollaborative projects. *ReCALL*, 16(1), 5-19. doi:10.1017/S0958344004000217.
- Papademetre, L., & Scarino, A. (2000). *Integrating culture learning in the languages classroom: A multi-perspective conceptual journey for teachers*. Melbourne: Language Australia.
- Pritchard, A. & Woollard, J. (2010). *Psychology for the classroom: Constructivism and social learning*. New York: Routledge.
- Schwartz, D. L., Lin, X. & Holmes, J. (2003). Technologies for learning from intercultural reflections. *Intercultural Education*, 14(3), 291-306. doi:10.1080/1467598032000117088.
- Shih, R. C. (2011). Can Web 2.0 technology assist college students in learning English writing? Integrating Facebook and peer assessment with blended learning. *Australian Journal of Educational Technology*, 27(5), 829-845.
- Tsai, Y. (2011). Attitudes: A role in the reflection of intercultural learning outcomes. *International Journal of Innovative Interdisciplinary Research*, 1(3), 139-149.
- Vygotsky, L. (1978). *Mind in society: The development of higher psychological processes*. Cambridge, MA: Harvard University Press.
- Wang, C. M. (2011). Instructional design for cross-cultural online collaboration: Grouping strategies and assignment design. *Australian Journal of Educational Technology*, 27(2), 243-258.
- Wang, C. M. (2012). Using Facebook for cross-cultural collaboration: The experience of students from Taiwan. *Educational Media International*, 49(1), 63-76.
- Wass, R., Harland, T. & Mercer, A. (2011). Scaffolding critical thinking in the zone of proximal development. *Higher Education Research & Development*, 30(3), 317-328. doi: 10.1080/07294360.2010.489237.
- Wood, D., Bruner, J. & Ross, G. (1976). The Role Of Tutoring In Problem Solving. *Journal of Child Psychology and Psychiatry*, 17, 89-100
- Wu, W. V., Marek, M. W. & Chen, N. S. (2013). Assessing cultural awareness and linguistic competency of EFL learners in a CMC-based active learning context. *System*, 41, 515-528. doi:10.1016/j.system.2013.05.004
- Ziegahn, L. (2005). Critical reflection on cultural difference in the computer conference. *Adult Education Quarterly*, 56(1), 39-64.

A Tagging Editor for Learner Corpora Annotation and Error Analysis

Lung-Hao LEE^{a,d}, Kuei-Ching LEE^{a,d}, Li-Ping CHANG^b,
Yuen-Hsien TSENG^{a*}, Liang-Chih YU^{c,d} & Hsin-Hsi CHEN^e

^a*Information Technology Center, National Taiwan Normal University, Taiwan*

^b*Mandarin Training Center, National Taiwan Normal University, Taiwan*

^c*Department of Information Management, Yuen-Ze University, Taiwan*

^d*Innovation Center for Big Data and Digital Convergence, Yuen-Ze University, Taiwan*

^e*Department of Computer Science and Information Engineering, National Taiwan University, Taiwan*

*samtseng@ntnu.edu.tw

Abstract: In this paper, we describe the development of the tagging editor for learner corpora annotation and computer-aided error analysis. We collect essays written by learners of Chinese as a foreign language for grammatical error annotation and correction. Our tagging editor is effective and enables the annotated corpus to be used in a shared task in ICCE 2014.

Keywords: Computer-aided error analysis, learner corpora, interlanguage, Mandarin Chinese

1. Introduction

Learner corpora are the collection of foreign language learners' produced responses, which are valuable resources for research of second language learning and teaching. For example, the International Corpus of Learner English (ICLE) is considered as one of the most important learner corpora. ICLE consists of argumentative essays written by advanced learners of English as a Foreign Language from different native language backgrounds (Granger, 2003). The first version was published in 2002. They are currently working towards the third version of this corpus. In addition, the Cambridge Learner Corpus (CLC) is made up of more than 200 thousands of examination scripts written by English learners speaking 148 different mother languages (Nicholls, 2003). CLC was established to assist English Language Teaching/Training (ELT) publishers to create aided materials, e.g., Cambridge dictionaries and ELT course books, addressed to their target users.

Annotated learner corpora play an important role to develop natural language processing techniques for educational applications. As an example, Assessing LEXical Knowledge (ALEK) system (Chodorow and Leacock, 2000) adopted statistical analysis from learner corpora to detect the errors of an English sentence. Izumi et al. (2003) detected English grammatical and lexical errors made by Japanese learners. Lee et al. (2013) proposed a linguistic rule based approach to detect grammatical errors written by learners of Chinese as a foreign language. Recently, the CoNLL 2013/2014 shared tasks focus on grammatical error correction for learners' English as a foreign language (Ng. et al. 2013). SIGHAN 2013/2014 bakeoffs on Chinese spelling check evaluation focus on developing automatic checker to detect and correct spelling errors (Wu et al. 2013).

However, to make learner corpora useful for these tasks, they must be annotated correctly before automated analysis can be applied. In this work, we design a tagging editor to help annotators to insert error tags and rewrite correct usages for the sentences in the learner corpus. In addition, our editor provides the function for error analysis, which further assists annotators to instantly discover incorrect or inconsistent tagging instances during the annotation process.

2. The Error Tagging Editor

The construction of a tagging editor includes designing tag-associated error categories arranged on a menu interface, which can help annotators to select and insert error tags alongside the wrong part of

the learners' written texts. In addition to error tagging, reconstruction of correct usages is usually needed in the annotation process. After the learner corpus is tagged and corrected, error analysis can be done quantitatively according to various kinds of users' interests.

Figure 1 shows a screenshot of the tagging editor. The functions of our tagging editor can be divided into three main parts: (1) Searching zone (the left panel): learners' written texts are stored in individual files accompanying with their metadata, such as the level describing the learner's language proficiency, the score of the learner's written texts, and the learner's mother-tongue language (ML). Our tagging editor can search learners' texts using these fields of metadata. The searching results can be listed in order by the unique ID with the (tagging | correction) status. The symbol "O" means a finished situation. In contrast, the symbol "X" represents that the texts need to be annotated. (2) Tagging zone (the middle panel): when the texts are loaded in this zone, annotators can select and insert error tags from the menu bar into some position of learners' texts. Inserted tags are shown in terms of square brackets in red color. (3) Correction zone (the right panel): annotators usually need to correct the error parts for correct usages. Correction zone is aligned paragraph-wisely with tagging zone to facilitate annotators' corrections. We highlight the changed texts in blue color. Besides, our tagging editor also reports error analysis, which benefits annotators to find incorrect/inconsistent tagging instances to be fixed in the verification procedure.

Our tagging editor is flexible enough to meet various annotation tasks for learner corpora in different language. The character encoding is in Unicode; the editor is developed in Java; both of which are cross-platform. Besides, annotators can add, delete or fix their self-defined error tags for their annotation tasks. The metadata is also optional. The tagging editor could load the learners' written texts even without the accompanying metadata.

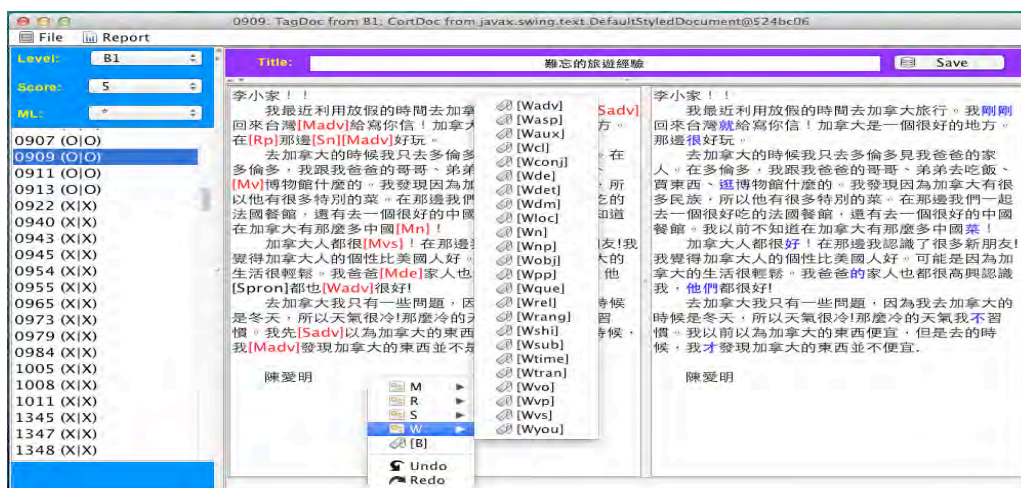

Figure 1. Screenshot of our tagging editor

3. The Annotation of TOCFL Learner Corpus

The annotated corpus using this tagger editor is mainly from the computer-based writing Test of Chinese as a Foreign Language (TOCFL). The writing test is designed according to the six proficiency levels of the Common European Framework of Reference (CEFR). Test takers have to complete two different tasks for each level. For example, for the A2 (Waystage level) candidates, they will be asked to write a note and describe a story after looking at four pictures. All candidates are asked to complete the writings on line. Each text is then scored on a 0-5 point scale. Score 5 means high-quality writings, score 3 is the threshold for passing the test, and so forth. There are 4,567 essays collected in the corpus so far.

For the purpose of studies in Chinese learners' interlanguage, hierarchical error tags are designed to annotate grammatical errors. There are two types of error tagging, one is target modification taxonomy, the other is linguistic category classification. The former includes four PADS error types: mis-ordering (Permutation), redundancy (Addition), omission (Deletion), and mis-selection (Substitution). The latter includes 36 linguistic types, e.g., noun, verb, preposition,

Developing and Evaluating a Test Generation Module to Support Personalized Phoneme-based Training

Yaheng ZOU^{a*}, Harumi KASHIWAGI^b, Yi SUN^c, Kazuhiro OHTSUKI^a & Min KANG^a

^a*Graduate School of Intercultural Studies, Kobe University, Japan*

^b*School of Languages and Communication, Kobe University, Japan*

Graduate School of Information Technology, Kobe Institute of Computing, Japan

*zouqing@gmail.com

Abstract: In this paper, we describe a test generation module to support personalized phoneme-based training in listening learning of English vocabulary. On the basis of the personalized phoneme error patterns detected by an error detection module, the test generation module would generate personalized listening tests. An evaluation experiment was conducted for evaluating the module.

Keywords: CALL System, Data Mining, Adaptive Learning, English Vocabulary Learning, Phoneme Perception

1. Introduction

In the past decade, adaptive learning has become considerable and there is a trend to develop the applications to generate adaptable materials. The trend also influences the field of computer assisted language learning (CALL). Item response theory was used to evaluate individual English vocabulary ability and a personalized mobile English vocabulary learning system has been developed (Chen and Chung, 2008). As enhancing communication skill becomes more and more important in foreign language education, CALL systems have been widely used in Japan as well. By CALL, students' learning log-data can be easily saved in database and the saved log-data gives us the possibility to automatically create and offer contents to students to guide their own learning processes or improve their weak points (Ueno, 2007). However, it has not been enough explored how to build personalized systems for listening learning.

On the other hand, it has been indicated that word recognition is the core process in listening of English (Rost, 2002). In some cognitive models of speech perception such as the cohort model, phoneme perception is considered as one of the key factors. In classroom education, it is well-known that Japanese learners have difficulties in distinguishing some special phonemes such as /r/ and /l/ (Horibe and Furuhashi, 1974) so that the phoneme-based training has been indicated to be an important learning strategy in vocabulary learning. Therefore, we consider that detecting individual weak-points at the phoneme level and conducting personalized phoneme-based training may help the individual enhance the listening comprehension ability in vocabulary learning.

In this paper, we describe a test generation module to support personalized phoneme-based training in English vocabulary learning. For a student, the log-data in word dictation tests are analyzed and the student's error patterns at the phoneme level are detected by the use of the error detection module developed in our previous work (Zou, Kashiwagi, Ohtsuki and Kang, 2013). On the basis of the error patterns, the test module will generate a test with alternative response questions for the student who is requested to discriminate minimal pairs of English words. In addition, an evaluation experiment is conducted in order to evaluate the module.

2. Vocabulary Test System and the Error Detection Module

We built a vocabulary test system in AMP (Apache, MySQL, and PHP) environment implemented the error detection module and the test module. The error detection module was targeted at analyzing the log-data in word dictation tests in that students are requested to input the spellings of English words as English answers and Japanese translations corresponding to the words.

In the error detection module, we have focused phoneme error detection on the detection of misperceptions, e.g. “slips of the ear” (Rost, 2002). We manually checked the wrong spellings and the corresponding right spellings in the past log-data and noted that most of the wrong answers could be categorized into mistakes of misperception. Most of the wrong answers were given as different English words in that only one phoneme or two phonemes are different from the right English words. We have used Japanese translations to examine whether a wrong spelling of a word represents the misunderstanding of the word or not. We suggested that wrong spellings mostly are in agreement with misunderstanding of words because there were only few answers in that the spellings of words were wrong but their Japanese translations were right. Certainly, the suggestion depends on the log-data collected.

According to the implemented algorithm, the error detection module would first decompose a right answer and a corresponding wrong answer into phonemes by the use of the CMU Pronouncing Dictionary (CMU pronouncing dictionary, n.d.), and then extract the phoneme error pair. Finally, the personalized phoneme error patterns would be detected by the use of the Apriori-like method in sequence data mining and be described as /Right-Phoneme/ -/Wrong-Phoneme/.

3. Test Generation Module

On the basis of the detection result by the error detection module, the test generation module would generate a test with alternative response questions in order to help an individual student or group distinguish phonemes that he/she or they mistook. We consider that the more a pair occurred in the results, the more it turns difficult for a student to distinguish the pair. In this work, the top error pair that is most frequently occurred in error patterns is selected to be the training target.

In a test generated by the module, each question consists of two words that are minimal pair and correspond to a phoneme error pair respectively. The words are randomly picked out from the minimal pair database. As an example, for the phoneme pair /r/ → /l/, a minimal pair would be the words “rock” and “lock”. One sound file corresponding to each minimal pair would be generated by the use of AT&T Natural Voice Engine.

4. Results in the Evaluation Experiment and Future Work

In order to evaluate the module, we conducted an evaluation experiment. We attempted to find out if the module can generate appropriate tests for training for individual students and if the training is effective to help students enhance their listening comprehension ability in vocabulary learning.

We designed a pretest-training-posttest experiment. In each pretest, a student needs to answer 20 word dictation questions. Once he/she submitted the answers, then a web page with his/her phoneme error patterns and 10 alternative response questions will be shown to him/her for training. After the training, the posttest with 15 word dictation questions will be presented. Each test for training and corresponding posttest are automatically generated by the test generation module.

In the experiment, we had two third-year students and two fourth-year students take four pretest-training-posttests numbered Test I, II, III and IV in one month period. We randomly chose the subjects from the students who have completed all necessary English courses provided by the university. The words both in the pretests and the posttests of Test I, II and III were randomly selected from the JACET 2000 list and the words in Test IV were those selected from the JACET 4000 list (JACET Vocabulary, n.d.). Students were previously requested to declare what phoneme pairs are difficult to distinguish and answer a paper-based test that measures vocabulary levels in reading. The result of the paper-based test shows that the subjects can understand almost all of words in the JACET 4000 list. This was aimed at decreasing spelling mistakes in the answers of the subjects. In the previous investigation, Student A and Student B declared that the /r/-/l/ pair is the most difficult pair to distinguish while Student C and Student D declared that the /v/-/b/ pair is the most difficult one.

Table 1 shows the auto-generated tests for Student B by the module. It is obvious that all tests for training are appropriately generated by the module although there are some duplicate minimal pairs.

Table 1. Auto-generated Tests For Phoneme-based Training

No.	Error Pairs	Words in Questions
I	/v/-/b/	vow-bow, rebel-revel, dub-dove, vein-bane, bale-veil, bane-vain, vent-bent, bale-veil, vat-bat, beer-veer
II	/r/-/l/	bright-blight, loot-root, glamour-grammar, rite-light, arrive- alive, flee-free, lock-rock, rocker-locker, ray-lay, rob-lob
III	/i/-/i:/	sip-seep, skim-scheme, kill-keel, bid-bead, bin-bean, skim- scheme, slip-sleep, ill-eel, piss-peace, slick-sleek
IV	/i/-/i:/	din-dean, piss-piece, sin-scene, shin-sheen, din-dean, piss- piece, sip-seep, each-itch, fist-feast, hip-heap

We examined the phoneme error pairs in the pretests of the subjects. It is noted that Student A had the same problem in all of the tests that she possibly cannot distinguish /r/ and /l/ very well as she declared. On the other hand, the weak points of the other subjects seem varying with the pretests as shown in Table 1. After the experiment, we manually performed the error detection module to deal with three kinds of accumulative pretest data that consists of the data in Test I and Test II, the data in Test I, II and III, and the data in Test I, II, III and IV, respectively. We noticed that the accumulative pretest data would provide a more stable result about the error pairs of all subjects. For Student A, the most difficult phoneme pair to distinguish is still the /r/-/l/ pair. For Student B, Student C and Student D, the /v/-/b/ pair become the most difficult one.

For investigating the effect of the tests for training, we compared the correct answer rates of the words in the pretests and the corresponding posttests by categorizing the words to the corresponding error pairs. The result by Fisher's exact test explains that there is a significant improvement in the posttests for Student A. However, there is no significant improvement observed for Student B, Student C and Student D. This may stem from whether the module detected the real weak points of the subjects or not. The consistency of the error pairs in the pretest data and the accumulative pretest data assume that the /r/-/l/ pair seems to be the real weak point of Student A. Conversely, for the other subjects, the module possibly has not appropriately estimated the real weak points.

Therefore, we assume that the auto-generated tests for training may help students enhance the perception of phonemes if the training targets are appropriately determined. For the question about how to make the auto-generated tests for training more effective, further investigation is needed.

Acknowledgements

This work was partially supported by JSPS KAKENHI Grant Number 23501108.

References

- Chen, C. M. & Chung, C. J. (2008). Personalized mobile English vocabulary learning system based on item response theory and learning memory cycle. *Computers & Education* 51, 624–645
- CMU Pronouncing Dictionary (n.d.). Retrieved May 23, 2014, from <http://www.speech.cs.cmu.edu/cgi-bin/cmudict>
- Horibe, N. & Furuhashi, S. (1974). Hierarchy of Aural Perception Difficulties at Several Levels of English Teaching. *JACET Bulletin*, 5, 87-106
- JACET Vocabulary (n.d.). Retrieved May 23, 2014, from <http://j-varg.sakura.ne.jp/publications/index.html>
- Rost, M. (2002). Teaching and Researching Listening. *Pearson Education*, Harlow
- Ueno, M. (2007). Data mining in e-Learning (in Japanese). *Japan Journal of Educational Technology*, 31(3), 271-283
- Zou, Y. H., Kashiwagi, H., Ohtsuki, K. & Kang, M. (2013). Developing a Learning Support System to Detect Phonemic Errors in Data of Listening Learning Log. *Proceedings of the International Conference on e-Commerce, e-Administration, e-Society, e-Education, and e-Technology*. 1145-1154

Enhancing EFL Learning of Elementary School Students through Human-Robot Interaction

Rong-Jyue Wang^a, Wen-Chi Vivian WU^{b*}, Yi-Chun Liu^c

^a*Department of Electronic Engineering, National Formosa University, Yunlin, Taiwan.*

^{b*}*Department of English, Providence University, Taichung, Taiwan*

^c*Department of Applied Foreign Languages, Chia Nan University of Pharmacy & Science, Tainan, Taiwan*

* *wcwu@pu.edu.tw*

Abstract: This study explored the potential for using in-house built teaching assistant robots in elementary school classrooms for the instruction of English as a Foreign Language (EFL). Both hardware and software design for such an innovative English program via interactions with the robot was included in this study. This Human-Robot Interaction (HRI), based on the results, led to better pedagogical effects on learning. This paper provides not only new directions for EFL instructors but also instructional design guidelines that other researchers can follow to create an innovative and enjoyable English classroom that employs an interactive robot as an assistant for enhancing English acquisition while simultaneously reducing the pressure and teaching load of the English instructors.

Keywords: teaching assistant robot, HRI, EFL, r-learning

1. Introduction

The robot industry is recognized as one of the most promising future industries throughout the world (Han, Jo, Jones & Jo, 2008). While a significant number of studies have revealed that r-Learning (Robot Learning) can bring new affordances to education, i.e. new capabilities, experimentation in r-Learning has mainly occurred in the fields of mathematics and science, the disciplines that actually develop the robots. The literature addressing the value of using educational robots to support second/foreign language learning is still skimpy. Chang, et al, (2010) echoed this observation by stating that only a few researchers have focused their attention on implementations of robotics for language teaching in elementary schools, and most have been located outside the cultural context of Taiwan. In recent years, there have been studies integrating applied robotics with education (Ryuey et al., 2008); however, research into robot assisted teaching and learning is still in its infant stages; therefore, more and more researchers are joining in the exploration of this field. The experimental results have shown that a communication robot can support human activity with its communication abilities, that proper programming can motivate children to desire additional interactions with the robot, and that robots have the potential to exhibit certain beneficial social skills when interacting with young children, the target population of the current study.

2. Hardware and Software Design of Teaching Assistant Robots

In view the obstacles to optimal English learning environments and the merits of using teaching assistant robots to facilitate language acquisition in the classroom, an intelligent teaching assistant robot named Powerful English Tutor (PET) was designed and created by the researchers to combine r-Learning functionality with a unique 3D visual experience. PET had the capability to exhibit various forms of communication and interaction with the student learners, such as facial expression, gestures, and motions on wheels. The main purposes of the creation of PET included (1) first to capture the students' attention as a result of PET's novel appearance, (2) then to motivate students to learn and to sustain their learning by engaging them with PET, and (3) eventually to ensure the students' mastery of the learning materials by interacting repeatedly with PET. The first author of this paper had been

involved in designing and producing robots successfully for several years and therefore brought significant expertise to this project.



Figure 1.

In order to fully support the instructional design of the class and achieve desired learning outcomes, the researchers employed a conceptual framework for this study based on three major theory-based teaching approaches to create an interactive learning environment for students including Communicative Language Teaching (CLT), Total Physical Response (TPR), and Storytelling, each incorporated into the databases that governed and managed PET's moment-by-moment actions. The CLT approach was used in the construction of databases for the teaching of self-introduction, conversation teaching, and teaching via storytelling. The TPR approach was applied in developing databases covering English character teaching, making use of entertaining body movements, singing, and dancing in order to help students internalize their lessons. The Storytelling approach was used in preparation of the databases for story teaching and learning.

The theory-based creation of PET's physical appearance was an important factor in the study. The upper part of PET was android in nature, with a head, face, ears, and arms, appearing similar to the cartoon characters familiar to the elementary school children. In particular, PET's face appeared on an LED display of 20x20 centimeters that could show smiles and a variety of other expressions (see figure 1). The lower body of PET was wheeled, to make it easily mobile. The android part of the body was able to imitate many kinds of human actions as well as perform a variety of teaching activities.

This physical design of PET was based on the need described in the introduction for an external appearance that was human-like or cartoon-like, with the following specific criteria: (1) The appearance of the robot must be appealing and interesting in order to attract the attention of young children; therefore, the researchers chose a humanoid structure with various cartoon-like elements appropriate to the needs of the curriculum (see Figure 1); (2) A 10.1" Tablet computer needed to be embedded in the robot's chest to show multimedia teaching content and to interact with students such as to increase the students' attention and motivation; (3) The upper part of the robot needed to imitate many kinds of human actions as well as perform a variety of teaching activities; (4) The robotic hands needed to easily hold teaching materials and English character cards to keep the attention of the students; and (5) The price of this robot, should it reach commercial production, needed to be reasonable for general classroom and family use.

3. Methods and Outcome

This study involved 31 third grade students who had participated in four consecutive rounds of robotic English teaching, each lasting about 50 minutes in length. The instructional design in this study employed the three major teaching approaches in the conceptual framework, Communicative Language Teaching, Total Physical Response, and Teaching Storytelling. PET visited the class four times, for about 50 minutes each time. The lessons were about the 26 English letters, self-introduction and body parts, conversation, and storytelling. The proficiency test was conducted at the end of the fourth season. Besides, a survey about the use of PET was administrated to the entire class and a focus group interview with 5 students was conducted afterwards with the consent obtained from their parents. Finally, the researchers' own classroom observations and video recordings were also used as a source for data collection.

The overall mean score of 4.2 (M=4.2) for the cutting-edge English instruction using PET indicated that generally speaking, the students were positive about their learning with PET in terms of elements such as joyfulness, interest, and motivation associated with their English learning. A negatively-skewed distribution of responses indicated the very successful role PET played in assisting teaching. When it comes to item-by-item data analysis, item 16, “I am looking forward to our future study of English in class” had a highest mean score of 4.53 (M=4.53), followed by item 10, “I’m willing to perform on the podium” with a second highest mean score of 4.52 (M=4.50). Item 11, “I like the pleasant atmosphere when studying the English in class” and item 6, “This is a fun and interesting English class” had a relatively high mean score of 4.36 (M=4.36) and 4.28 (M=4.28), respectively, which proved that using robots as teaching assistants in class created a more pleasant learning environment as well as a more positive learning experiences.

The interview data also indicated that the students enjoyed having PET because it helped the instructor to teach English and also believed that PET performed its job well. Student D mentioned that “This English study with PET was a very interesting and fun experience because PET could perform a variety of different movements and also served as a good teaching assistant.” In addition, the students believed that PET could enhance their motivation to study English and that HRI could also be valuable in other classes. Student A said, “I wish that PET could be here in class all the time and could also appear in the other classes to help us learn the other subjects because I feel I’m more motivated to study English.” Student C focused on the issue of confidence in studying English by saying, “I felt more confident and less anxious when PET was there, especially when being asked questions.”

The observation from the teacher reveals that PET assisted her in teaching by reducing the pressure and load of teaching and said that she would love to continue using PET as her teaching assistant in the future. She also found that the operation and interface of PET was simply and user friendly, but saw the need for an improvement in the richness and complexity of teaching materials, should PET be integrated into a semester-long lesson plan. To summarize, the multiple sources of data collected from both the teacher and the students showed that teaching assistant robots were highly valued and strongly recommended for in-class English instruction.

4. Conclusion

Given the world-wide need to teach younger and younger children foreign languages, and the resulting need to develop language teaching methodology suitable for these younger children, it is natural to assume that technology should play a prominent role. The researchers have demonstrated that a teaching assistant robot, such as PET, can accomplish multiple goals, such as fostering positive learning experiences, promoting active learning, motivating young students to learn, improving learning effectiveness, and providing a counterpoint to teacher-led classroom lessons. The researchers also believe that teaching assistant robots like PET could also be used to help teach other languages to younger children, with appropriate alternative databases. The researchers, therefore, have concluded that this field, using Human-Robot-Interaction to support EFL instruction for young students, has high potential and is deserving of extensive attention in the field of both education and technology development.

Acknowledgment

This research was partially supported by the National Science Council in Taiwan through Grant NSC 99-2628-E-150-046, NSC 101-2511-S-269-002-MY3 and NSC 100-2511-S-110-001-MY3.

References

- Chang, C.-W., Lee, J.-H., Chao, P.-Y., Wang, C.-Y. & Chen, G.-D. (2010a). Exploring the Possibility of Using Humanoid Robots as Instructional Tools for Teaching a Second Language in Primary School. *Educational Technology & Society*, 13 (2), 13–24.
- Han, J., Jo, M., Jones, V. & Jo, J.H. (2008). Comparative study on the educational use of home robots for children. *Journal of Information processing System*, 4(4).
- Ryu, H. J., Kwak, S. S., and Kim, M. S. (2008). Design factors for external form of robots as elementary school teaching assistants. *The Bulletin of Japanese Society for Science of Design (JSSD)*, 54(5), 39-48.

Essay Development Schemata to Support English Composition

Hidenobu KUNICHIKA^{a*}, Yuki IKEDA^b & Akira TAKEUCHI^a

^a*Faculty of Computer Science and Systems Engineering, Kyushu Inst. of Tech., Japan*

^b*Graduate School of Computer Science and Systems Engineering, Kyushu Inst. of Tech., Japan*

*kunitika@ci.kyutech.ac.jp

Abstract: We propose essay development schemata to support learners in English essay writing. The schemata are expressed by unified vocabulary in unified level of detail. Since essay structures are expressed as such schemata, learners will be able to know what the structures of essay exist, recognize how each structure is different, and what kinds of information are necessary for composing a type of essay. Computers, moreover, can support learners in composing essays by referring to the schemata as the knowledge of the logical structures of English essay.

Keywords: English Learning, EFL Learning, Essay Writing, Paragraph Writing, CALL

1. Introduction

One of the most difficult tasks for English as a foreign language (EFL) learners is to compose a long persuasive passage. In order to compose such sentences in English, we need to have the knowledge of not only words and grammar, but also the logical structure of English. However many EFL learners do not have sufficient knowledge of the logical structure.

Although many intelligent computer-assisted language learning (ICALL) systems and support systems for composing sentences have been developed, it is difficult for these systems to support users who have insufficient knowledge of the logical structures of English. For example, Criterion (Educational Testing Service, 2007) and Writer's Companion (Visions Technology in Education, 2007) are useful systems. They, however, give users only templates which correspond to typical logical structures because target users of these systems are basically people who have the knowledge of logical structures. These systems may not provide enough support for users who have insufficient knowledge of logical structures of English.

We have already focused on the logical structure of paragraphs, defined paragraph development schemata which express typical logical structures, and implemented support systems for organizing paragraphs (Kunichika, Miyazaki and Takeuchi, 2009). At present, we are now focusing on English essays composed of several paragraphs. In order to implement support systems for essay writing, the purpose of this work is to define the knowledge of the logical structures of essays. In this paper, we describe the knowledge and its utilization.

2. Essay Development Schemata

When we look for instructions on essay writing, we can find many textbooks. However, it is difficult for EFL learners to understand explanations of logical structures, because the types of structures introduced in books differ, vocabulary and the level of detail are not unified and there are only a few examples. Moreover, because the definitions of logical structures are written in natural language, they still have ambiguity and it is difficult for computers to treat them as knowledge without changing their formats.

In order to implement support systems for essay writing, computers need to have knowledge of logical structures of essays. There are different types of essays, depending on the purpose people have for writing an essay. Although an essay basically has three parts: introduction, body and conclusion, the details of the body vary according to the type of essay. Thus, computers need to know the detailed logical structure that corresponds to the essay type.

We examined eighteen textbooks for essay writing, e.g. (Chin, Reid, Wray and Yamazaki, 2012) and (Folse, Muchmore-Vokoun and Solomon, 2010), and identified seven types of essays: Argumentative, Narrative, Comparative, Cause-and-Effect, Process, Descriptive and Classification. After that, we formalized information on the logical structure of each type, and defined the knowledge as schema called essay development schema (EDS). The knowledge of logical structures can be defined by the following information.

- *Structure*: *Structure* expresses the logical structure of an essay, and is defined by a sequence of the roles of components in an essay. An essay consists of several paragraphs. Thus, components of *structure* correspond to paragraphs. Because the type of a paragraph is restricted according to the role of the paragraph in an essay, *Structure* also expresses the relationships between the roles and the types of paragraphs.
- *Explanation*: What and how should be described in each component of *Structure*. *Explanation* is expressed in natural language, and referred by learners, e.g. when composing the outline of an essay.
- *Tip*: Important points for composing a good essay and/or matters that require attention. *Tip* is also expressed in natural language. It is useful when revising an essay.
- *Words and phrases*: Information on words and phrases frequently used in a type of essay. The information consists of words, their parts of speech, the component of *Structure* in which the words are used, and restrictions on their use. *Words and phrases* are used for selecting appropriate words, e.g. a computer suggests words when rewriting an essay.
- *Condition*: Some EDSs have two types of logical structure. *Condition* expresses the information for selecting the type of logical structure.

EDSs are expressed by unified vocabulary in a unified level of detail. Since the logical structures of an essay are expressed as EDSs, we can reduce their ambiguity. That is to say,

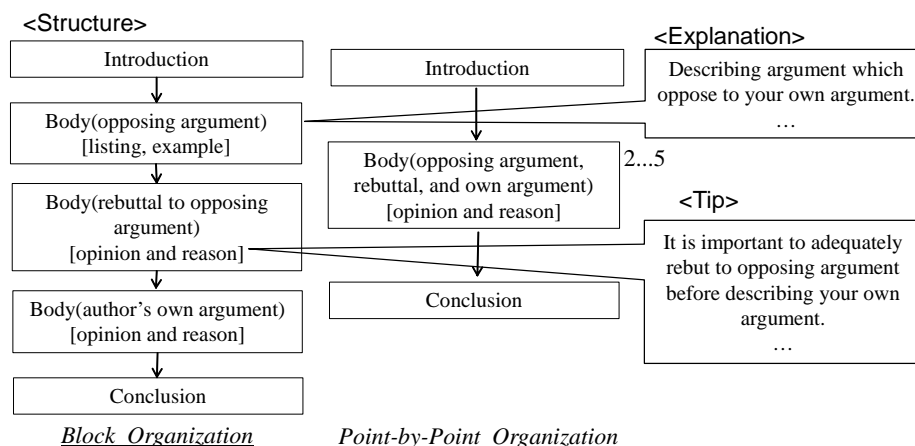

<Condition>

- The number of items ≥ 4 -> Style=Point-by-Point Organization
- Type=describing opposing argument, rebutting to the argument, and stating author's own argument in different paragraphs -> Style=Block Organization
- Type=describing opposing argument, rebutting to the argument, and stating author's own argument in the same paragraph -> Style=Point-by-Point Organization

<Words and Phrases>

- Component=Body (rebuttal to opposing argument) -> although(conj), conversely(adv), ...
- Component=Body (author's own argument) -> actually(adv), in fact(p,n), indeed(adv), ...

Figure 1. The EDS of an argumentative essay

learners and computers will be able to know what types of essays exist, how each logical structure differs, and what kinds of information are necessary for composing a type of essay.

As an example, we show the EDS of argumentative essay in Figure 1. In *structure*, squares are components, i.e. paragraphs, numbers attached to components express repetitions of the components, and names in square brackets are types of paragraphs corresponding to the component. There are two types of logical structures: one is block organization and the other is point-by-point organization. Selecting one type of structure depends on the number of items or the policy of an essay. For example, when four or more items are described, point-by-point organization is suitable. *Condition* expresses such relationships as shown in Figure 1. *Words and phrases* keeps information on words and phrases frequently used in each component of *structure*.

3. Utilization of Essay Development Schemata

EDSs can be referred to by learners and computers as knowledge on essay writing. We give you examples of the utilization of EDS in this section. The writing process of an essay consists of four steps: pre-writing, drafting, reviewing and revising, and rewriting. The first step of the essay writing is pre-writing. In this step, authors need to gather ideas they will use to write about the topic, and organize the essay. That is, deciding which of the ideas they will use and where they will put the ideas in the essay. For learners who are unfamiliar with organizing an essay, computers will be able to propose some outlines of essays. When learners gather ideas, our system asks them to express the roles of the ideas in the paragraphs and essays. The system composes the outlines of paragraphs by referring to the roles of the ideas in the paragraphs (Kunichika, Miyazaki and Takeuchi, 2009). Next, the system selects several of the paragraphs by referring to the roles of both the gathered ideas and components of *structure* of an EDS, and puts each outline of the selected paragraphs into the appropriate component of the *structure* by also referring to *condition*. By repeating these processes, the system will be able to compose several essay outlines and propose them to learners. We have defined the knowledge of logical structures in a computer readable format. Therefore, computers can automatically compose the outlines of essays although already-existing systems give users only templates of essays.

4. Conclusions

We have defined EDSs which express typical logical structures of an English essay, and described their utilization. As our future task, we will evaluate EDSs and implement an English composition support system with EDSs for the four steps of essay writing. Moreover, we will expand this work from an essay to a larger unit such as a paper.

Acknowledgements

This work is supported in part by JSPS KAKENHI Grant Number 25350288.

References

- Chin, P., Reid, S., Wray, S., & Yamazaki, Y. (2012). *Academic Writing Skills 2*, CAMBRIDGE.
- Educational Testing Service. (2007). *The Criterion Teaching Guide*, Retrieved May 14, 2014, from http://www.ets.org/Media/Resources_For/Higher_Education/pdf/Criterion_Teacher_Guide_web_6487.pdf
- Folse, K. S., Muchmore-Vokoun, A., & Solomon, E. V. (2010). *Great Essays*, Cengage Learning.
- Kunichika, H., Miyazaki, C. & Takeuchi, A. (2009). An Intelligent Partner for Organizing a Paragraph, *Proceedings of AIED 2009*, 549-556.
- Visions Technology in Education. (2007). *Writer's Companion*, Visions Technology in Education.

Fostering college students' reading comprehension with online annotations

Hui-Chin YEH*, Yu-Hsin CHIANG, Yu-Fen YANG, Janice LIAO,

*Graduate School of Applied Foreign Languages, National Yunlin University of
and Technology, Taiwan*

*hyeh@yuntech.edu.tw

Abstract: The study aims to investigate students' progress in reading comprehension in an online annotation system. This study adopted quantitative and qualitative methodologies. The results showed that students made significant progress in reading comprehension after receiving instruction with online annotation. Moreover, students who made more progress employed the strategies of questioning and annotation more frequently than those who made less progress. To sum up, instead of solely teaching multiple reading strategies, it was recommended that multiple reading strategies should incorporate online annotation for helping students overcome their reading difficulties.

Keywords: Reading comprehension, reciprocal teaching, online annotation, collaborative learning

1. Introduction

Concerning the issue of improving college students' reading comprehension, a substantial body of research has suggested that teaching reading strategies is one of the most effective means for helping students to overcome difficulties whilst reading (Dreyer & Nel, 2003). Rhoder (2002) stated that teaching students to apply reading strategies allows learners to become more active and engaged in their reading process. By making good use of reading strategies, students are able to solve certain problems so as to overcome comprehension failures. Therefore, teaching readers how to use effective reading strategies is an essential procedure in the reading classroom, and thus should be integrated into classroom instruction.

Among the studies which employ multiple strategies in reading comprehension, Reciprocal Teaching (RT) has been reported as an effective method to enhance learners' reading comprehension (Alfassi, 1998; Fevre, Moore, & Wilkinson, 2003). One possibility to solve existing problems of reading instruction is to combine RT instruction with peer-assisted learning arrangements in which students read and annotate collaboratively (Spörer, Brunstein, & Kieschke, 2009).. According to Su et al. (2010), annotation is a useful strategy as it leads the learner to engage with the content to be annotated to ensure both its relevance and significance is understood. Likewise, Robert (2009) further stated that annotation practices are particularly useful for knowledge sharing within collaborative learning frameworks. In general, annotation has been considered as an effective strategy since it helps collaborative learning by allowing learners to: (1) draw attention of group members to a specific content, (2) organize and discuss the new material, (3) review others' thoughts in the form of annotations, and (4) improve through receiving feedback and corrections from instructors or experienced learners.

Since taking notes is a common behavior that occurs in the classroom, there is a need to provide annotation systems even in online learning environments as well. Several studies have shown the positive effects of online collaborative annotation on learning performance (Marshall & Brush, 2004; Robert, 2009). To this end, this study attempts to combine RT with a collaborative annotation system to compensate the difficulty of current teaching challenges, and then report on the effectiveness of reciprocal teaching incorporating the online annotation system to support teachers and students in college reading instruction. In addition, the differences in strategies used among students who made more progress and less progress when undergoing RT procedures are investigated.

2. Design of the Reading Instruction Incorporating an Online Annotation System

2.1 Reading Instruction

The course was designed based on the instructional framework of reciprocal teaching proposed by Brown and Palincsar (1984). The key strategies of reciprocal teaching include predicting, clarifying, questioning and summarizing. During the 12-week study, students were instructed in four strategies of RT. After receiving the explicit teaching, the online annotation system was introduced to the students. Through the online annotation system, peers not only can collaboratively read and annotate the texts, but also share the ideas and reading strategies. Additionally, since students' reading behavior, reading process and their collaboration with peers in small group discussion can be recorded, scaffolding can be provided for the peers and instructors when they encounter reading difficulties.

2.2 Online Annotation System

This study takes advantage of multiple functions provided by Google Docs to incorporate in reading instruction. *The annotation tool* is the main function that the students use when undergoing RT procedures. Student can exert this tool to highlight and annotate unknown words, keywords, topic sentences, and supporting ideas. In addition, the students were asked to write down the main ideas of each paragraph, and then integrate them into a summary. In this online setting, they can independently as well as collaboratively annotate the texts based on reciprocal teaching procedures. *The document shared mechanism* allows students to share their notes, invite others for collaborative reading and provide collaborative annotation of the texts. In this online setting, students can observe peers' work, discuss with their peers and give responses to peers' annotation of the text. *The chat room* is a common online learning environment. The students can use this space to generate questions, and process a thread of discussion with their peers in more natural conditions. Besides, with this chat room, the instructor can immediately provide some prompts to scaffold students once they encounter difficulties.

3. Conclusion

The result of this study showed that students made significant progress in reading comprehension after receiving reciprocal teaching with online annotations. Moreover, the differences in strategies used among students who made more progress and less progress when undergoing RT procedures were identified. Students who made more progress employed the strategies of questioning and annotation more frequently than those who made less progress. To sum up, it was recommended that multiple reading strategies such as reciprocal teaching should be integrated into reading classrooms since students' reading performance was improved after receiving reciprocal teaching. Furthermore, when implementing the RT, it is suggested that the instructor can incorporate the online

annotation for helping students overcome their reading difficulties.

Acknowledgement

This paper was supported by the Ministry of Science and Technology under the grant number MOST 103-2410-H-224 -013.

References

- Alfassi, M. (1998). Reading for meaning: The efficacy of reciprocal teaching in fostering reading comprehension in high school students in remedial reading classes. *American Educational Research Journal*, 35(2), 309-332.
- Brown, A. L. & Palinscar, A. S. (1984). Reciprocal teaching of comprehension-fostering and comprehension-monitoring activities. *Cognition and instruction*, 1(2), 117-175.
- Dreyer, C., & Nel, C. (2003). Teaching reading strategies and reading comprehension within a technology-enhanced learning environment. *System*, 31(3), 349-365.
- Fevre, D. M., Moore, D. W., & Wilkinson, I. A. (2003). Tape-assisted reciprocal teaching: Cognitive bootstrapping for poor decoders. *British Journal of Educational Psychology*, 73(1), 37-58.
- Marshall, C. C., & Brush, A. J. B. (2004). Exploring the relationship between personal and public annotations. In *Proceedings of the 2004 ACE/IEEE Conference on Digital Libraries (JCDL'04)* (pp. 349–357).
- Rhoder, C. (2002). Mindful reading: Strategy training that facilitates transfer. *Journal of Adolescent & Adult Literacy*, 45(6), 498-512.
- Robert, C. A. (2009). Annotation for knowledge sharing in a collaborative environment. *Journal of Knowledge Management*, 13(1), 111-119.
- Spörer, N., Brunstein, J. C., & Kieschke, U. L. F. (2009). Improving students' reading comprehension skills: Effects of strategy instruction and reciprocal teaching. *Learning and Instruction*, 19(3), 272-286.

Game-based Mobile Learning Companion for L2 Vocabulary Acquisition

Fang-Chuan OU YANG^a, Yu-Mei Yang^{b*}, Wen-Chi Vivian WU^c

^a*Department of Information Management, Chien Hsin University of Science and Technology, Chung-Li, Taiwan*

^{b*}*Department of Applied Foreign Languages, Chien-Kuo Technology University, Changhua, Taiwan*

^c*Department of English Language, Literature and Linguistics, Providence University, Taichung, Taiwan*

* *cathy@ctu.edu.tw*

Abstract: With the emerging development of Digital Game-Based Learning (DGBL), a growing body of research has begun to explore the effectiveness of gamification of language learning. This paper introduces an evolving study which aims to explore the effectiveness of a mobile learning companion game, named “MyEVA (My English Vocabulary Assistant) Mobile”, which was originally developed by combining the metacognitive and cognitive strategies and mobile gaming technologies. In the current status of this study, the proposed system has finished development and continues to elaborate the usability according to the language experts and student suggestion. In the future, a mixed research will be conducted to investigate whether flow and enjoyment lead to improvement in L2 vocabulary learning.

Keywords: Digital game-based learning (DGBL), game-based language learning, L2 vocabulary learning

1. Introduction

Digital Game-Based Learning (DGBL) has become a new medium of reference in the language learning field over the past few years. Cornillie et al. (2012) explored learner perceptions of corrective feedback in an immersive game for English pragmatics. Miller and Hegelheimer (2006) employed a strategic life simulation video game, “The Sims”, with tree-condition experimental design (access mandatory supplemental materials / voluntary access to supplemental materials/ with no supplemental materials) in L2 courses. Ranalli (2008) replicated Miller and Hegelheimer’s (2006) research findings and also investigated whether structured play of The Sims, combined with specially designed support materials, could allow L2 learners of English not only to use the game but also to enhance their grammar and vocabulary knowledge. Rankin et al. (2006) utilized the massive multiplayer online role-playing game (MMORPG), “Ever Quest 2”, with a second language methodology to create an immersive virtual learning environment for second language acquisition (SLA). Cobb and Horst (2011) employed a video game for ESL vocabulary learning, “My Word Coach”, for the Nintendo DS or Wii, distributed commercially since late 2007.

Summarizing the literature, we find following research issues in the game-based language learning field: 1) There are only a few studies that utilize games for L2 vocabulary acquisition, 2) Most of current studies focus on using existing commercial games, which were originally created for entertainment and lack capability for vocabulary learning pedagogy, and 3) Most of the games used in language research are role-playing games (RPG) and they must be played at fixed locations (by video game console, TV, or computer).

This study describes a mobile learning companion game, named “MyEVA (My English Vocabulary Assistant) Mobile”, which was originally developed by combining the metacognitive and cognitive strategies and mobile gaming technologies. Different from the RPG games utilized by current body of research on game-based language learning, MyEVA Mobile has only a central virtual character, EVA

(English Vocabulary Assistant), who is capable of providing students with individual and useful information and helping them pass different vocabulary learning tasks. After completing different learning tasks and tests, the students can obtain virtual currency to buy variant items to dress up their EVA, or send virtual currency and items to their friends. We expect our game design of mobile learning companion to be helpful in developing a closer relationship between the students and the learning companion, which will further contribute to sustaining the students' participatory motivation. As a result, the gameplay will systematically help the students expand their L2 vocabulary.

2. System Modeling

In this study, we are developing a systematic approach to model MyEVA Mobile, called the Metacognitive and Cognitive Model of Interactivity (MCMI), as shown in the Figure 1. The MCMI describes the connection between metacognitive and cognitive processes, the types of interactivity, and the skills the students are expected to develop using MyEVA Mobile. The MCMI provides (1) A framework the developers should refer to, and (2) Interprets the users' behaviors in MyEVA Mobile. The MCMI will be useful when the researchers utilize EDM (Education Data Mining) techniques to identify the behavior patterns in MyEVA Mobile.

The MCMI is comprised of two types of interactivity that the users engage in while playing MyEVA Mobile: (1) *Game Playing*, i.e., purchasing items to enhance the EVA, and (2) *Solving Tasks*, i.e., solving different learning tasks to earn virtual currency and game experience. When the users play the game, they are expected to engage in two processes: (A) Item Information Seeking, i.e., finding a favorite item and acquiring its price, and (B) Find Solutions to Obtain Items, i.e., understanding the game rules and knowing how to obtain the items. (1) and (2) together represent the metacognitive strategies linked to Learning Companion Construction. To successfully execute metacognitive strategies, for which the users should correctly execute related cognitive processes. Searching Shopping Mall, for instance, represents a cognitive strategy the users can employ to obtain the item information; Shopping Mall Interface is a system function provided in MyEVA Mobile for the users to execute the cognitive strategy of Searching Shopping Mall.

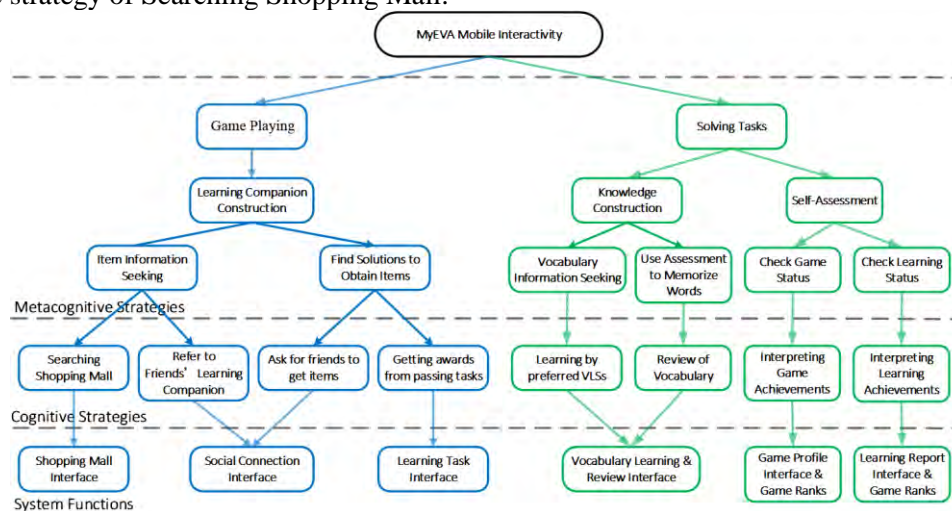

Figure 1. The Metacognitive and Cognitive Model of Interactivity

3. MyEVA Mobile

According to the MCMI, we developed MyEVA Mobile with five major functions: Vocabulary Learning & Review, Learning Task, Shopping Mall, Game Profile, and Game Ranks. System screenshots are shown in Figure 2. MyEVA has two main types of interactivity: *Game Playing* and *Solving Tasks*. The game design of MyEVA Mobile centralizes on dressing the user's virtual learning companion with various featured items, acquired by paying with virtual currency. The virtual currency of game can be obtained through completing different tasks in MyEVA Mobile. The *task* is the central

learning activity in MyEVA Mobile, requiring students to learn a number of words and pass a vocabulary proficiency test within the game. During a learning task, MyEVA Mobile provides six cognitive-oriented vocabulary learning strategies (VLS) to help students improve their vocabulary knowledge: Word Card Strategy, Flash Card Strategy, Imagery Strategy, Synonym strategy, Antonym strategy, and Example Sentence Strategy. The function of the Shopping Mall is the most charming characteristic of the game play. “Buying favorite items” will motivate the students to engage in solving different learning tasks to obtain more virtual currency. MyEVA Mobile provides over 300 items in the Shopping Mall. When the students identify their favorite items, they can purchase them for their EVAs, and the portrait of EVA will change instantly in the social community of MyEVA Mobile.



Figure 2. (A) Main interface (B) Shopping Mall interface (C) Learning Task interface

4. Conclusion and Future Work

This study describes a mobile learning companion game which is under on-going development, called MyEVA Mobile, which acts as a companion to the students during learning activities. In the current status of this study, development of the system has been completed. In the future, we aim to explore two research questions: (1) How does MyEVA Mobile improve the ESL students’ L2 vocabulary acquisition? (2) How does MyEVA Mobile affect the ESL students’ perceptions of learning, flow, and enjoyment in the game? A mixed research with vocabulary proficiency pre- and post-tests; a questionnaire survey of perceived learning, flow, and engagement (Barzilai & Blau, 2014); and EDM techniques will be conducted to explore the effectiveness and behavior patterns of MyEVA Mobile. The experimental results of this study are expected to provide insights for language teachers, curriculum designers, and, in particular, system developers of mobile-assisted language learning.

Acknowledgements

The authors would like to thank the NSC of the Republic of China, Taiwan, for financially supporting this research under contract No. NSC 102-2511-S-231 -001.

References

- Barzilai, S., & Blau, I. (2014). Scaffolding game-based learning: Impact on learning achievements, perceived learning, and game experiences. *Computer & Education*, 70, 65-79.
- Cobb, T., & Horst, M. (2011). Does word coach coach words? *CALICO Journal*, 28(3), 639-661.
- Cornillie, F., Claebout, G., & Desmet, P. (2012). Between learning and playing? Exploring learners’ perceptions of corrective feedback in an immersive game for English pragmatics. *ReCALL*, 24, 257-278.
- Miller, M., & Hegelheimer, V. (2006). The SIMS meet ESL: Incorporating authentic computer simulation games into the language classroom. *International Journal of Interactive Technology and Smart Education*, 3(4), 311-328.
- Ranalli, J. (2008). Learning English with the Sims: Exploring authentic computer simulation games for second language learning. *Computer Assisted Language Learning*, 21(5), 441-455.
- Rankin, Y. A., Gold, R., & Gooch, B. (2006). 3D role-playing games as language learning tools. In , Vol. 25. Paper presented at the *EuroGraphics 2006*. Vienna: Austria. September 4-8, 2006

Online Peer Feedback and Learner Autonomy in EFL Writing Class

SilihWARNI^{a*}, Gunawan SURYOPUTRO^a

^a*University of Muhammadiyah Prof. Dr HAMKA, Indonesia*

*silih1980@gmail.com

Abstract: The information and communication technology has been utilized by most universities in Indonesia though it is rarely integrated in teaching and learning activities in classes. This paper, as part of a study to foster learner autonomy using technology based approach, investigated the roles of online peer feedback toward learner autonomy development. The data used in this study involved students' interview transcriptions. The results showed that online peer feedback has facilitated students' metacognitive strategies and enhanced their motivation to learn writing.

Keywords: learner autonomy, online peer feedback, metacognitive strategies

1. Introduction

One of the prominent issues in the theory and practice of language teaching recently is the importance of facilitating students to foster autonomy in their learning (Benson, 2011). It is in line with the goal of Indonesian national education agenda, which puts learner autonomy as a part of its higher education goals (Indonesian National Education Law 2012). Benson (2011) suggested that one of the approaches to foster autonomy is technology based approach. This paper is part of a study to foster learner autonomy in EFL writing class using technology approach that focuses on the roles of online peer feedback toward learner autonomy development.

2. Literature review

As the aim of the study is to investigate the roles of online peer feedback on fostering learner autonomy, the areas of literature discussed in this section cover learner autonomy and online peer feedback.

2.1 Learner autonomy

Autonomy has been broadly defined by Benson (2011) as "the capacity to take control over one's own learning". This definition becomes the basis of this study since the construct of 'control' is open to empirical investigation. Dimensions of control suggested by Benson involve control over learning management, control over cognitive processes and control over learning content. As the forms that learner autonomy takes differ according to the person and the context, an autonomous learner then is described as someone whose learning has some of those components, but not necessarily all of them (Benson, 2011).

Reinders (2010) emphasises autonomy as a process and distinguishes a number of phases in the process that start with awareness raising. A useful concept of learner autonomy development in language classroom context involves four phases; defining tasks, setting goals and planning, enacting study tactics and strategies, and metacognitively adapting studying (Reinders, 2010). Since learning in classroom context involves social aspect, "autonomy thus includes the notion of interdependence, that is being responsible for one's own conduct in the social context: being able to cooperate with others and solve conflicts in constructive ways" (Kohonen, 1992). This implies the importance of collaboration in developing learner autonomy.

2.2 *Online Peer feedback*

Peer feedback is defined as “a communication process through which learners enter into dialogues related to performance and standards”(Liu and Carless, 2006). Hyland and Hyland (2001) mentioned three functions of feedback which are praise, criticism and suggestion. During the peer feedback activities, students may receive appreciation, or they might be criticized. Furthermore, students may receive suggestions for improving their works.

In this study, online peer feedback refers to peer feedback activities that are done online by making use of blog or weblog as the online medium. A blog is “a web application that displays serial entries, asynchronously developed, by employing simple user interfaces and allowing users to easily maintain content or add new dated entries, with the advantages of inserting graphics, multimedia, video and audio, not to mention the text, which is an important aspect of blogging” (Wei, 2010; Meyer, 2010; Lai & Chen, 2010; Deng & Yuen, 2011; Fageeh 2011). One of the characteristics of blog is that it enables self-publishing that encourages ownership on its contents (Jones, 2006).

3. **Methodology**

The study involved 16 students of English Education Graduate School at University of Muhammadiyah Prof. Dr. HAMKA, enrolling academic writing class in the first semester of 2013. During the semester, students completed 3 writing assignments. Each assignment involved posting the writing draft on their blog, peer feedback activities, making the revision and posting the final draft. Among those 16 students, five were chosen to take part in the in-depth interviews. Semi-structured interviews were applied to reveal students’ perceptions toward the roles of the online peer feedback on fostering learner autonomy. Semi-structured interviews can be a meaningful way to generate data by talking interactively with people, asking them questions, listening to them, gaining access to their accounts and articulation or analysing their use of language and construction of discourse (Mason 2002).

4. **Findings and discussions**

The findings of the study discussed in this paper are restricted to metacognitive strategy and motivation as two of important aspects in fostering learner autonomy.

4.2.1 *Metacognitive strategy*

Even though the word strategy was not used explicitly, metacognitive strategies emerged as prominent themes from the analysis of students’ interviews. According to O’Malley and Chamot (1990), the metacognitive strategies involve ‘thinking about the learning process, planning for learning, monitoring the learning tasks, and evaluating how well one has learned’. These strategies are the potential components of learner autonomy because “they are concerned with control over learning management”, a dimension of control over learning that an autonomus learner needs to have (Benson, 2011).

Giving feedback on others’ works has guided students to understand the writing aspects they need to learn more. They realized that in order to give constructive feedback, they had to understand well the aspects of writing they commented on. Regarding the feedback they received from others, they believed that others could be better in looking at the mistakes they made, that they themselves might not be aware of. The peer feedback has raised their awareness of their weaknesses and enabled them to concentrate on the areas of writing they need to improve. Moreover, the feedback has given them direction to plan further learning for a better achievement in the future.

4.2.2 *Motivation*

The effort to foster learner autonomy cannot be separated from enhancing students’ motivation since motivation is the pre-condition for autonomy (Jiménez Raya et al., 2007). In the study, students

perceived that publishing their works to the public by making use of blog as the online medium was a motivating factor for them in the academic writing class. This finding is relevant to a study conducted by Jones (2006), revealing that publishing for an authentic audience motivated the students' writing and interaction. Among motivation components in the learning situation suggested by Dornyei (1994a), *intrinsic interest* and *satisfaction* in the outcome of an activity have emerged in the study. Students felt satisfied with their progress and the learning process occurred there. People could see how their writings had improved because the blog enables their progress to be documented from time to time. The praises they received from their friends about their works had raised the feeling of satisfaction as well. Furthermore, the choice of Wordpress as the blog site to publish their writings and do the peer comments became an interesting part for the students especially those who like designing a lot. The blog site offered them advantages of features and space to create a blog design as they like.

5. Conclusions

This paper, as part of a study to foster learner autonomy in academic writing class, was aimed to reveal the roles of online peer feedback toward learner autonomy development. Results of the study showed that the online peer feedback has supported students in facilitating their metacognitive strategies and raised their motivation to learn writing.

Acknowledgements

We would like to thank all the people who supported the implementation of the online peer feedback in the academic writing class at University of Muhammadiyah Prof. Dr. HAMKA. Special thanks go to Prof. Terry Lamb and Dr. Sabine Little, who have guided me in planning the program and monitored the overall processes.

References

- Benson, P. (2011). *Teaching and researching autonomy in language learning* (2nd Ed). Harlow, England ; N.Y.: Harlow, England ; N.Y. : Pearson Education Limited.
- Dornyei, Z. (1994a). Motivation and motivating in the foreign language classroom. *Modern Language Journal*, 78, 273—84
- Fageeh, A. I. (2011). EFL Learners' Use of Blogging for Developing Writing Skills and Enhancing Attitudes towards English Learning: An Exploratory Study. *Journal of Language & Literature* (20780303), 2(1).
- Hyland, F. and Hyland, K. (2001). Sugaring the pill; praise and criticism in written feedback. *Journal of Second Language Writing*. 10 (3), 185-212
- Jimenez Raya, M., Lamb, T., & Vieira, F. (2007). Pedagogy for autonomy in language education in Europe: Towards a framework for learner and teacher development. *Dublin: Authentik*
- Jones, S. J. (2006). *Bloggging and ESL writing: A case study of how students responded to the use of Weblogs as a pedagogical tool for the writing process approach in a community college ESL writing class* (Doctoral dissertation, The University of Texas at Austin).
- Kohonen, V. (1992) 'Experiential language learning: Second language learning as cooperative learner education'. In D. Nunan (ed.) *Collaborative Language Learning and Teaching*. Cambridge: Cambridge University Press, pp. 14–39.
- Liu, N. F., & Carless, D. (2006). Peer feedback: the learning element of peer assessment. *Teaching in Higher Education*, 11(3), 279-290.
- Mason, J. (2002). *Qualitative researching* (2nd Ed). London: Sage Publications Ltd
- O'Malley, J. M., Chamot, A. U. (1990). *Learning Strategies in Second Language Acquisition*. Cambridge: Cambridge University Press
- Reinders, H. (2010). Towards a classroom pedagogy for learner autonomy: A framework of independent language learning skills. *Australian Journal of Teacher Education*, 35(5), 4

Survey on Japanese University Students' Learning Experiences with ICT and Open Sources for International Collaboration

Yoshiko GODA^{a*}, Masanori YAMADA^b, Yumi ISHIGE^c, & Junko HANDA^d

^a*Research Center for Higher Education, Kumamoto University, Japan*

^b*Faculty of Arts and Science, Kyushu University, Japan*

^c*Faculty of Modern Social Studies, Otemae University, Japan*

^d*Faculty of Modern Social Studies, Saitama Institute of Technology, Japan*

*ygod@kumamoto-u.ac.jp

Abstract: The purpose of this research is to report university students' learning experiences with information communication technology (ICT) and open educational sources (OES) for global learning in Japan. The survey of 327 Japanese university students included seven multiple-choice items and 16 open-ended questions about students' learning experiences. The results showed that the most frequent use of ICT, including computer-mediated communication, is a discussion function of Blackboard for formal collaborative learning and LINE for informal learning. Learning with OES is less popular; only one student had taken a two-month course via YouTube provided by a Japanese university, and only two students had learned with foreign students online. The students' preferred activities for future international collaborative learning included project-based learning, casual chats and conversation, discussion, and e-mail exchange. Favored topics were ones related to their majors, international situations, the environment, cultural differences, and school life. Language proficiency, communication, cultural differences, and values and beliefs caused the most anxiety and concern for international collaboration, but the time gap, legal issues, and infrastructure were also considered.

Keywords: global learning, information and communication technology (ICT), computer mediated communication (CMC), open educational sources (OES)

1. Introduction

The globalization of society requires Japanese university students to acquire skills to communicate and work collaboratively and creatively with foreigners. Efforts to promote the internationalization and global human development of university education are strongly encouraged in Japan (Central Council for Education, 2010). Information Communication Technology (ICT) and Open Educational Sources (OES) allow people to learn at their own pace and communicate with each other without the restriction of time and space and in turn enable us to provide more global learning opportunities for our students. The use of ICT in collaborative learning among multiple nationalities in Japan has been documented (e.g., Sugiyama et al., 2005) but is uncommon and not yet a tool provided by many universities.

The goal of our research project is to design and develop a support system for international collaborative learning for learners as active learners and for teachers as facilitators. To attain this goal, we investigate the current problems for international collaboration via ICT in Japan, especially from the students' perspectives. Students' responses to the researcher-designed questionnaire focus on the use of ICT for both formal and informal learning, use of OES, the collaborative learning experience with foreign students, preferred activities, and topics for future international collaboration.

2. Research Method

The survey-type research method was employed in this study. Three hundred sixty-nine students registered to four computer-assisted language learning courses were asked to participate in the survey.

The students were all sophomores at a national university in Japan and were registered in the departments of Pharmacy, Social Environment, Information Technology, and Mechanical Engineering. Excluding Pharmacy, the students' English proficiency level was at the university average (444 to 480), with TOEIC-IP score averages from 412 to 450 over the last five years. Students in Pharmacy had scores averaging from 465 to 525 over the last five years, which was slightly above the university mean.

The researcher-designed questionnaire was used to collect the data in this study. The survey consisted of seven multiple-choice items and 16 open-ended questions about students' learning experiences and was divided into three main sections: frequency of ICT use for formal and informal collaborative learning, OES, and learning experiences and opinions for international collaborative learning. The questionnaire was conducted with an assessment function of Blackboard, a learning management system, in one of the computer assisted language learning (CALL) classes during the first semester. The CALL classroom was equipped with one computer per student, and the students responded to the questionnaire via their assigned computer for about fifteen minutes.

The data collected were analyzed descriptively per section. For ICT use in collaborative learning, graphs were created to compare ICT applications used by the students. The responses of the last two questions related to future international collaborative learning and were organized with KJ methods.

3. Results

The results on the frequency of ICT use for formal collaborative learning are shown in Figure 1. There were ten alternatives in the multiple-choice question; Mixi, Facebook, Twitter, Google+, Wiki, Cybozu, LINE, ChatWork, Blackboard, Moodle, and Other. The number and percentages above the bars in the figure indicate the number and percentage (of total) of students who selected the targeted alternative. Blackboard was reported as the most frequently used ICT technology for collaborative learning in a formal educational setting. Google+, Wiki, LINE, and Moodle were among the group in the second most frequently used (21.71% to 27.22%). Figure 2 illustrates the frequency of ICT use for informal collaborative learning. LINE ($n = 299$, 91.44%) was the most frequently used, followed by Twitter ($n = 210$, 64.22%) and then Facebook ($n = 155$, 47.40%). In contrast to the formal setting results, Blackboard and Moodle were less popular in informal settings. Skype, Viper, Pinger, and Yahoo Answers were included as "Other."

As learning experiences with OES, only one student out of 327 students (0.31%) responded as having experience with open educational sources for learning. Over a two-month period, this student had studied the course content, which was provided by one of the best universities in Japan. He considered the course to be challenging but interesting. Related to learning experience from international collaboration, only two students (0.61%) answered "yes" regarding collaborative learning experiences with foreign students via ICT and CMC. Student A had had conferences with Skype for three years during middle education. He discussed some topics with foreign students over Skype. A positive point of the activity was that he could communicate with foreign students

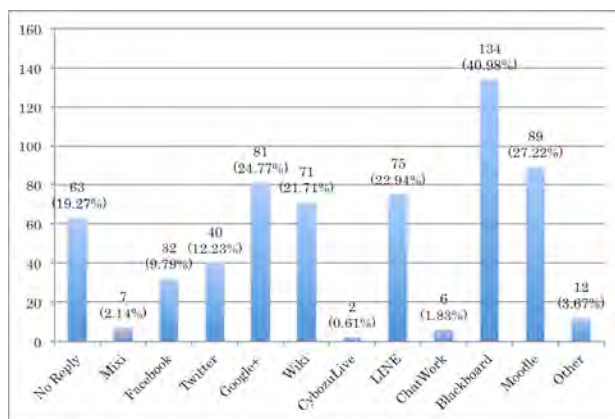

Figure 1. Frequently Used ICT for Collaborative Learning in a Formal Setting.

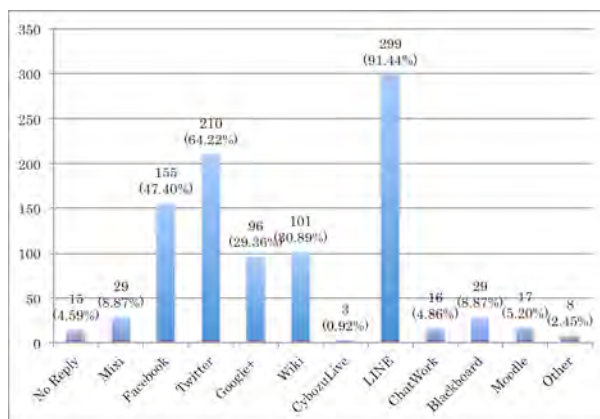

Figure 2. Frequently used ICT for Collaborative Learning in an Informal Setting.

face-to-face via Skype, while the negative points included the difficulty in time management because of the time gap and summer time. Student B had a school trip to New Zealand during high school. In order to prepare for this trip, he exchanged mail with the foreign students who were assigned to his group. He reflected on his learning experience as an enjoyable learning activity.

Table 1 summarizes the results of preferences and expectations for future international collaborative learning, and Table 2 organizes the results related to anxieties and concerns. The students' preferred activities for future international collaborative learning included project-based learning, casual chat and conversation, discussion, and e-mail exchange. Their favorite topics were ones related to their majors, international situations, the environment, cultural differences, and school life. Language proficiency, communication, cultural differences, and values and beliefs were reported as anxieties and concerns for international collaboration, and time gap, legal issues, and infrastructure were also considered.

Table 1: Students' Preferences and Expectations for

Future International Collaborative Learning		
	Categories	Number of Respondents
Activities	Conversation & Chat	28
	Project	25
	Creation and Manufacturing	13
	Group Discussion	2
	Mail Exchange	1
	Research	1
Topics	Specialty	25
	Environment	14
	International Issues and Trends	12
	Language/ English Learning	7
	Value Difference	2
	Hobby	1
	Human Rights	1
	Others	16
	No Preferences	15
	Negative Attitudes toward International Collaborative Learning	6
	No Response	88

Table 2: Anxiety for Future International

Collaborative Learning		
	Categories	Respondent Number
	Language Proficiency	153
	Communication	64
	Culture Differences	15
	Time Gap	8
	Nonverbal Communication	5
	Value Difference	5
	Legal Issues	2
	Others	11
	No Anxiety	11
	Cannot Imagine and Don't Know	7
	Negative Attitudes toward International Collaborative Learning	4
	No Response	66

4. Discussion and Future Research

The survey revealed that not many students had opportunities to learn with foreign students via ICT. Only one student had used OES to study one university course via YouTube. The results highlight the crucial need of Japanese universities to provide more meaningful opportunities for university students to collaboratively learn with foreign students. In order to design a course and activities for international collaborative learning, the students' preferences and concerns, as documented in this research, should be considered to implement a feasible, sustainable, and learner-centered collaborative learning experience. Similarly, in the design of facilitation for collaborative learning activities, students' needs are significant and should be considered based on the results of this research.

In future research, not only students' expectation and concerns but also those of teachers and stakeholders should be considered. This fundamental survey should also be implemented in other countries to examine cultural differences. Through several pilot and experimental projects, we would like to develop and improve a facilitation model for multiple foreign teachers dispersed in different places.

Acknowledgments

This work was supported by JSPS KAKENHI Grant Number 26284079.

References

- Central Council for Education, Working Group on the Promotion of Globalizing Universities. (2010). The Concept of Global Human Resource Development Focusing on the East Asian Region. (<http://www.mext.go.jp/english/highered/1303540.htm>) Accessed on May 2, 2014.
- Sugiyama, K., Funakoshi, K., Koda, T., Fujishiro, Y., & Ishida, T. (2005). Supporting multilingual collaboration with semantic annotation. *IPSS SIG Technical Reports*, 2005-ICS-139(27), 157-162.

Teacher Learning in a Virtual Field Experience

Hui-Chin YEH^{a*} Yu-Fen YANG,^b Shih-Hsien YANG^c

^a *Graduate School of Applied Foreign Languages, National Yunlin University of Science and Technology, Taiwan*

^b *Department of Applied Foreign Languages, National Yunlin University of Science and Technology, Taiwan*

^b *Department of Applied Foreign Languages, National Formosa University, Taiwan*

*hyeh@yuntech.edu.tw

Abstract: This study aims to explore how teaching assistants (TAs) respond to students' written texts through a virtual field experience. Five prospective teachers served as TAs to revise 20 college student writers' texts in the English as a Foreign Language (EFL) context in an online virtual field experience. This study draws on the notions of hard and soft scaffolds to conceptualize the way TAs provide and reflect on their written support. It was found that TAs' preconceptions of effective scaffolding in text revision were challenged and reexamined. An online virtual field experience nurtured teacher learning with efficient support.

Keywords: Teacher Learning, Teaching Assistants, Virtual field experience

1. Introduction

This study draws on the notions of *hard and soft scaffolds* (Brush & Saye, 2002; Saye & Brush, 2002) to theorize support and assistance that teachers provide to develop students' writing skills. Saye and Brush (2002) advocate that the nature of scaffolds should be individualized. It can be referred to as a number of instructional strategies to facilitate learning processes. Useful scaffolding is used to bridge the gap between what learners can achieve by themselves and what they can achieve with the aid of capable actors such as teachers, adults, or peers (Beed, Hawkins, & Roller, 1991; Raymond, 2000; Rogoff, 1990; Vygotsky, 1978). The capable actors must tap into learners' actual developmental levels at first and then provide the support slightly beyond the learners' current level so as to make the instruction more accessible to learners. Scaffolding can then be withdrawn when learners gain the competence over their learning (Beed, Hawkins, & Roller, 1991). The ultimate goal of scaffolding is to develop students to be autonomous learners who can apply what they've learned previously to accomplish similar tasks on their own (Rogoff & Gardener, 1984). Along the same line, teacher written feedback scaffolds students to become independent writers through raising their awareness of grammar usages and writing conventions.

To address effective scaffolds that support both teaching and learning, Brush and Saye (2002) reconceptualize scaffolding as *soft and hard scaffolds*. Soft scaffolds are defined as "dynamic, situation-specific aid provided by a teacher or peer to help with the learning process" (Brush & Saye, 2002, p. 2). This form of support requires teachers to assess students' current level of writing ability and meet their immediate learning needs (Saye & Brush, 2002). Rather than a one-size-fits-all strategy, soft scaffolds focus on support at one particular moment in time: teachers ask for clarification, request information, and correct grammatical mistakes throughout the student writing process.

Hard scaffolds refer to the "static support that can be anticipated and planned in advance based upon typical student difficulties with a task" (Brush & Saye, 2002, p. 2). This assistance is framed ahead when teachers have identified student writers' difficulties and types of effective comments as opposed to randomly underlining every word and sentence. In this present research, TAs analyzed both students'

revised drafts and evaluations to explore their feedback practice and change. The virtual field experience assists prospective teachers to transform their personal beliefs, knowledge, and experience in scaffolding to facilitate actual learning (Pence & Macgillivray, 2007). When TAs identify gaps between their teaching assumptions and current students' needs, hard scaffolds can be forged to develop new understandings of written support.

In this study, an online writing system is developed to provide the virtual field experience for prospective teachers to serve as teaching assistants (TAs) who scaffolded students through multiple writing stages. In this study, student writers (SWs) were required to write an essay and posted it online for TAs to comment on. After student writers posted their first drafts, TAs were arranged to correct and respond to students' essays. Student writers were encouraged to evaluate how helpful TAs' corrections and comments were and rated them based upon a 5-point scale. Finally, each student writer revised his/her original essay according to TAs' suggestions and reposted it. TAs used student writers' evaluation to examine the effectiveness of their scaffolding.

According to the retrospective interviews, five TAs all appreciated the virtual field experience in which their preconceptions of effective scaffolding in text revision were challenged and reexamined. The TAs' reinterpretations of their scaffolding resulted from their observations on the student writers' revision process and evaluations on the TAs' comments and corrections. By observing student writers' revision process, the TAs evaluated whether their corrections and comments could effectively scaffold student writers to revise their texts. From the students' evaluations, the TAs could check whether student writers encountered difficulty in understanding the TAs' comments and corrections. The TAs started to think as student writers to explore the reasons why their student writers could not benefit from their scaffolding and what scaffolding student writers really needed in the revision process. If TAs were not provided with the opportunity to reexamine the effectiveness of the scaffolding by checking students' responses and revised texts, they could never recognize the importance of guiding students to think independently, analyze students' language proficiency levels, and encourage students to express personal viewpoints and voices in their reaction essays.

Through ongoing reciprocal examinations of their prior and new preconceptions of scaffolding, prospective teachers learn to develop as professionals (Freeman & Johnson, 1998; Ritchie & Wilson, 2000). Particularly, online learning environment conceals the student participants' identities, so their perceptions of feedback usefulness may be more candid in helping TAs reflect on their commentary behaviors and further examine their teaching assumptions and current student's needs. The students' revised texts and their feedback evaluation provide opportunities for TAs to identify soft scaffolds—situated support and pedagogical intervention that the student writers need. More importantly, the online feedback submission promotes interactions between the students and TAs who dialogue what constitutes effective feedback. Then, TAs can draw upon these inputs to formulate their hard scaffolds—pre-planned instructions by anticipating learners' difficulties and challenges (Brush & Saye, 2002; Saye & Brush, 2002). When the TAs found that they should identify their students' background knowledge and select common errors, these types of assistances could specifically tap into learning-to-write processes and become TAs' pedagogical knowledge.

Appropriately developed computer-mediated tools increase opportunities to achieve instructional goals. As the purpose of teacher feedback is to help students become independent writers and improve their writing skills (Hyland & Hyland, 2006), future research can include in what way in-service teachers experience online feedback practice and examine similarities and differences between traditional and computer-assisted approaches. The effect of feedback provided in different teaching and learning environments on student writing can be also addressed in further studies.

Acknowledgement

This paper was supported by the National Science Council of Taiwan under the grant NSC (100-2628-H-224-001).

References

- Beed, P., Hawkins, M., & Roller, C. (1991). Moving learners towards independence: the power of scaffolded instruction. *The Reading Teacher*, 44(9), 648–655.
- Brush, T. A., & Saye, J. W. (2002). A summary of research exploring hard and soft scaffolding for teachers and students using a multimedia supported learning environment. *The Journal of Interactive Online Learning*, 1, 1-12.
- Freeman, D., & Johnson, K. E. (1998). Reconceptualizing the knowledge-base of language teacher education. *TESOL Quarterly*, 32, 397-417.
- Hyland, K., & Hyland, F. (2006). Feedback on second language students' writing. *Language Teaching*, 39, 83-101.
- Pence, H. M., & Macgillivray, I. K. (2008). The impact of an international field experiences on perservice teachers. *Teaching and Teacher Education*, 24, 14-25.
- Raymond, E. (2000). Cognitive characteristics. *Learners with mild disabilities* (pp. 169-201). Needham Heights, MA: Allyn & Bacon, A Pearson Education Company.
- Ritchie, J. S. & Wilson, D. E. (2000). *Teacher narrative as critical inquiry: Rewriting the script*. New York: Teachers College.
- Rogoff, B. (1990). *Apprenticeship in thinking: Cognitive development in social context*. New York: Oxford University Press.
- Rogoff, B., & Gardener, W. P. (1984). Guidance in cognitive development: An examination of mother–child instruction. In B. Rogoff & J. Lave (Eds.), *Everyday cognition: Its development in social contexts*. Cambridge, MA: Harvard University Press.
- Saye J. W., & Brush, T. (2002). Scaffolding critical reasoning about history and social issues in multimedia-supported learning environments. *Educational Technology Research & Development*, 50, 77-96.

The Relationships among Learners' Backgrounds, Metacognitive Vocabulary Learning Strategy Awareness and Mobile Vocabulary Learning Readiness

Chih-Cheng LIN* & De-Yan WU

English Department, National Taiwan Normal University, Taiwan

*cclin@ntnu.edu.tw

Abstract: The present study aims to investigate the relationship between the metacognitive vocabulary learning strategy awareness and the mobile vocabulary learning readiness among Taiwanese junior high school EFL students. A total of 372 participants completed a questionnaire which assessed their readiness towards mobile vocabulary learning. They also completed the Metacognitive Vocabulary Learning Strategy Awareness Questionnaire, which evaluated their awareness and perceived use of vocabulary learning strategies. The results indicated that the learners' proficiency levels and ownership duration significantly influenced their readiness towards mobile vocabulary learning and metacognitive vocabulary learning strategy awareness. In addition, a significant correlation between the learners' readiness and awareness was found.

Keywords: m-learning, metacognitive vocabulary learning strategy awareness, mobile vocabulary learning readiness

1. Introduction

Learners, with the help of metacognition knowledge, can choose relevant technological devices for learning and use effective strategies to facilitate achieving learning goals (Bannert, Hildebrand & Mengelkamp, 2009). In such technology-enhanced environments, successful learners especially need metacognition to identify the differences among available technological tools (Antonietti, Colombo & Lozotsev, 2008). The awareness of metacognitive strategy use may also have effects on success of learning with technology; and, metacognitive instruction should be incorporated in e-learning (Kramarski & Zeichner, 2001); and, instructors should evaluate learners' metacognition, analyze their status of metacognitive knowledge and intervene to help them become more aware of their use of metacognitive strategies (Oxford, 2002; Stadler & Bromme, 2008). As Miangah and Nezarat (2012) point out, vocabulary learning is one of the most commonly discussed areas of mobile-assisted language learning (MALL). In the present study, we intend to first explore whether the various backgrounds of Taiwanese junior high school EFL students would influence their awareness of metacognitive vocabulary learning strategies and their readiness towards mobile-assisted vocabulary learning. The relationship between the aforementioned awareness and readiness was analyzed and discussed.

2. Methods

2.1 Participants

A number of 372 copies of questionnaires completed by the students from the four districts of a metropolitan area in Taiwan were collected and analyzed in the present study.

2.2 The Instruments

The questionnaire comprised three sections. The first section was designed to elicit the demographic information of grades, sex, proficiency levels and duration of ownership. Section two assessed their readiness towards using smartphones to learn English vocabulary and included familiarity, attitude and experience. The awareness and perceived use of metacognitive vocabulary learning strategies, including selective attention, self-initiation and consolidation, were then assessed in the last section.

3. Results and Findings

3.1 Descriptive Statistics

The participants' means, standard deviations and the results of the tests of significance of the readiness in general and the three components (test value = 3) are listed in Table 1 and those of the metacognitive awareness in general and the three components (test value = 3) are listed in Table 2.

Table 1: Descriptive statistics and *t*-tests of readiness and its components (N = 372).

Component	Mean (Average per item)	SD	t	Sig. (2-tailed)
Readiness	3.3343	.57406	11.232	.000
Familiarity	3.1871	.77261	4.671	.000
Attitude	3.3118	.73611	8.170	.000
Experience	3.5040	.49441	19.663	.000

Table 2: Descriptive statistics and *t*-tests of metacognitive awareness and its components (N = 372).

Component	Mean (Average per item)	SD	t	Sig. (2-tailed)
Metacognitive Awareness	3.5367	.90982	11.378	.000
Selective Attention	3.5493	1.08426	9.771	.000
Self-Initiation	3.9151	.91144	19.364	.000
Consolidation	3.1458	1.02877	2.734	.007

3.2 The Relationships among Demographic Variables and Mobile Vocabulary Learning Readiness

In order to investigate the relationships among the demographic variables and the components of mobile readiness, *t*-tests and one-way ANOVA were conducted. According to the results of ANOVA, the differences between the learners' grades in regard to Familiarity and Attitude were not significant. Nevertheless, the learners in 9th grade might have more experiences in mobile vocabulary learning than the 7th graders did. The results of sex revealed that the differences between male and female learners were insignificant. With respect to the levels, the results showed that those who had passed the intermediate level or higher had better readiness than the learners who had only passed the elementary level. In terms of the duration of ownership, the learners owning and using smartphones for more than 1 year surpassed the other learners in all the three components. Those who had been using smartphones less than 6 months fell behind the other two groups of learners in regard to their readiness.

3.3 The Relationships among Demographic Variables and Metacognitive Vocabulary Learning Strategy Awareness

The results of ANOVA showed that the differences among the learners of different current grade levels were insignificant in terms of Selective Attention and Self-Initiation. The 9th graders were more aware of their Consolidation strategy use than 8th graders. As for the learners' sex, the results again were insignificant. In terms of proficiency levels, the learners who had passed the GEPT tests outperformed those who had not passed any of the tests. The results showed that those who had passed the

intermediate level or higher had better awareness than the learners who had only passed the elementary level. When the duration of ownership is concerned, the learners owning and using smartphones for more than 1 year surpassed the other learners in all the three components. Those who had been using smartphones less than 6 months fell behind the other two groups of learners.

3.4 Predictors of Readiness towards Mobile Vocabulary Learning

The inter-correlation of the variables is presented in Table 3.

Table 3: Inter-correlation among variables.

Variables	1. Readiness	2. Selective Attention	3. Self-Initiation	4. Consolidation
1. Readiness	1.000	.827**	.775**	.808**
2. Selective Attention		1.000	.722**	.742**
3. Self-Initiation			1.000	.695**
4. Consolidation				1.000

** Correlation is significant at the 0.01.

The multiple correlation coefficient (R) was found to be .892 and the coefficient of determination (R^2) was .796. The three types of metacognitive vocabulary learning strategy awareness could explain 79.6% of the variance of the criterion variable, meaning the three variables predicted 79.6% of the mobile vocabulary learning readiness. As for the coefficients, it was found that Selective Attention ($t = 9.964, p = .000$), Self-Initiation ($t = 7.159, p = .000$) and Consolidation ($t = 9.119, p = .000$) were significant predictors of readiness towards mobile vocabulary learning. The most significant predictor of the readiness towards mobile vocabulary learning was Selective Attention; the second is Consolidation; and Self-Initiation had the least effect to predict or explain the variance. The equation for the standardized multiple regression model is: Learners' readiness towards mobile vocabulary learning = $.387 \times$ Selective Attention + $.341 \times$ Consolidation + $.259 \times$ Self-Initiation.

In sum, the learners' grades, proficiency levels and their ownership duration were found to have significant influences on their awareness of metacognitive strategy use and readiness towards mobile learning. Furthermore, the learners' metacognitive vocabulary learning strategy awareness was found to be positively and significantly related to their mobile vocabulary learning readiness and the three components of metacognitive strategy awareness were strong predictors of the learners' readiness towards mobile vocabulary learning. The present study suggests that educators and instructors take learners' proficiency levels and ownership duration into consideration before designing and integrating mobile technologies into language curricula.

References

- Antonietti, A., Colombo, B., & Lozotsev, Y. (2008). Undergraduates' metacognitive knowledge about the psychological effects of different kinds of computer-supported instructional tools. *Computers in Human Behavior, 24*(5), 2172–2198.
- Bannert, M., Hildebrand, M., & Mengelkamp, C. (2009). Effects of a metacognitive support device in learning environments. *Computers in Human Behavior, 25*(4), 829–835.
- Kramarski, B. & Feldman, Y. (2000) Internet in the Classroom: Effects on Reading Comprehension, Motivation and Metacognitive Awareness, *Educational Media International, 37*:3, 149-155, DOI: 10.1080/09523980050184709.
- Kramarski, B., & Zeichner, O. (2001). Using technology to enhance mathematical reasoning: Effects of feedback and self-regulation learning. *Educational Media International, 38*(2/3), 77-82.
- Miangah, T. M., & Nezarat, A. (2012). Mobile-Assisted Language Learning. *International Journal of Distributed & Parallel Systems, 3*(1).
- Oxford, R. (2002). Language learning strategies. In R. Carter & D. Nunan (Eds.), *The Cambridge guide to teaching English to speakers of other languages* (pp. 166–172). Cambridge: Cambridge University Press.
- Paolucci, R. (1998). Hypermedia and learning.
- Stadtler, M., & Bromme, R. (2008). Effects of the metacognitive computer-tool metaware on the web search of laypersons. *Computers in Human Behavior, 24*(3), 716-737.

Topic: Using popular mobile application software to increase learner motivation

Pin-hsiang Natalie WU^{a*} & Michelle KAWAMURA^b

^a*Applied Foreign Languages Department, Chien-kuo Technology University, Taiwan*

^b*College of Economics, Ritsumeikan University, Japan*

*natalie@ctu.edu.tw

Abstract

Immersed as they are in technology today, educators have more options to create a curriculum using the most-advanced and convenient means in their classrooms. Teachers of English as a foreign language can now utilize technology-enhanced communication to connect their students to other English learners in different countries and cultures. With the widespread of instant messaging system and the increasingly easy access to hand-held devices such as cell phones and tablet computers, English learners worldwide can experience authentic cross-cultural communication for language and cultural learning. This paper argued that using popular mobile software and incorporating cross-cultural learning in an instructional design of a language learning course can increase learner motivation for cross-cultural communication, whereas the cross-cultural learning context can lead to willingness to communicate in an international context. In order to examine the willingness to communicate cross-culturally of English learners, a culturally oriented, collaborative language-learning project integrating mobile mediating technology was implemented on university students of two cultural groups. Data were collected for quantitative analysis in order to explore participants' willingness to communicate cross-culturally based on the utility of LINE and the cross-cultural learning context. Results showed that both the use of LINE and the effectiveness of cross-cultural collaboration gained from the instructional design had significantly predicted these learners' future willingness to communicate in an international context.

Keywords: LINE, mediating technologies, m-learning, willingness to communicate, cross-cultural

Introduction

The purpose of English teaching and learning in non-native English speaking countries shall consider 21st century globalizing context particularly in an environment shaped by mediating communication technology development. Steering away from the traditional focuses of grammar, reading and translation, English as foreign language should be taught based on a combination of fostering intercultural awareness with authentic environment using the language learned. Raising cultural awareness, promoting intercultural communicative effectiveness, and incorporating online technologies in higher education curriculum are becoming prevalent since these strategies are believed to be beneficial to students' future career in the workplace (Fitzpatrick & O'Dowd, 2012). Technology closed the gap of borders of physical geographical presence and brought people with more opportunities to communicate across cultures. Currently more focuses are placed on mobile technology, as the portability of mobile devices makes learning easy.

This study examined the effect on students' future willingness to communicate in intercultural context, from a cross-cultural, language learning instructional design via the popular mobile phone application software, LINE, between Taiwanese and Japanese college students. The researchers propose that the online collaboration influenced by the partnership and efficiency of Instant Message enabled via LINE will increase students' willingness to engage in communication in cross-cultural context in an effective

Liu, C.-C. et al. (Eds.) (2014). Proceedings of the 22nd International Conference on Computers in Education. Japan: Asia-Pacific Society for Computers in Education

way.

Design and instrument

Japan and Taiwan has one hour time difference which work as an advantage in this research design for authentic communication. Using the application, LINE, students were assigned 3 guided questions embedded with cultures and personal believes. Participants exchanged information using Instant Messaging and actual verbal correspondence via LINE are media for communication between students of two cultural groups for 4 weeks. In the final week students had to hand in individual report to their instructors respectively. One of the reasons the researchers selected LINE is that a certain amount of familiarity with mobile devices on the part of learners will increase the effectiveness of mobile communication, as the difficulty of using a new tool may possibly hinder their willingness to communicate (Hockly 2013).

Methodology

In order to statistically investigate how the effectiveness an instrumental design incorporating cross-cultural English learning in mobile communicative context can impact learners' future willingness to communicate in an international context, stepwise multiple regression analysis was conducted, with “future willingness to communicate in an international context” as the dependent variable, and “the use of LINE” and student's perception of “the effectiveness of the cross-cultural English learning activity” as independent variables.

Participants

In fall semester of 2013, a total of sixty 2nd year university students of non-English majors were selected according to their English level and accessibility to mobile device. Thirty Japanese and thirty Taiwanese students were randomly assigned to pairs as a team for collaborative learning. Each group contained 6 students, with 3 from each cultural group. Students' English level was determined by a pre-test of English designed by the researchers.

The measures

We used a survey to investigate possible factors influencing student future willingness to communicate in an international context. This study had used a self-created survey that includes three measures.

Future willingness to communicate cross-culturally measurement consisted of four items. These items were adopted from and revised part of Yashima's (2002) question items measuring “Intercultural friendship Orientation in English Learning” within the L2 Willingness to Communicate (WTC) structure, to indicate future willingness in an international context. These items were used to measure if students have interest in communicating with people of different cultural backgrounds. Cronbach Alpha coefficient was .85, indicating a high reliability. Ratings for the 5 items were averaged as a continuous scale for future willingness to communicate cross-culturally.

Cross-cultural cooperative learning effectiveness measurement consisted of four items. These items were adopted from and revised part of Koh & Hill's (2009) measurement on student satisfaction toward an online group work to indicate the feeling of success in a cooperative learning environment. Cronbach Alpha coefficient was .86, indicating a high reliability. Ratings for the 5 items were averaged as a

Liu, C.-C. et al. (Eds.) (2014). Proceedings of the 22nd International Conference on Computers in Education. Japan: Asia-Pacific Society for Computers in Education

continuous scale for cross-cultural cooperative learning effectiveness.

Using mobile application software measurement consisted of five items. These items were self-created based on several recent studies. These items were used to measure participant's satisfaction using LINE as a mediating tool for cross-cultural cooperative learning. The first two items in the measurement asked participants to self-report their digital literacy about using LINE for communication. The following two questions asked students to self evaluate their satisfaction toward using LINE for cross-cultural learning. The last item was a global question measuring overall mental effort for the synchronous mobile mediating communication context. Alpha coefficient was .78. Ratings for the 5 items were averaged as a continuous scale for using mobile application software as tool.

Result and Analysis

“Cross-cultural collaboration effectiveness” and “using mobile application software” had significantly predicted the variance in “future willingness to communicate in an international context.” ($F(2,30) = 24.512, p=.000^{***}$). The two variables together account for about 62% of the variance. The figure shows that the fitting is very appropriate. Additionally, beta value had shown significant influences that the two predictor variables influence “future willingness to communicate cross-cultural,” with “cross-cultural collaboration effectiveness” variable showing beta value .599 ($\beta=.599, p<.00$) and “using mobile application software” showing beta value ($\beta=.279, p<.05$). The result shows that students' future willingness to communicate in an international context is affected by their perception of an effective collaboration from an instructional designed in cultural context and the use of popular mobile mediating software, with learning effectiveness showing higher influence than the use of popular mobile software.

Conclusion

Communication in an international context is becoming a pervasive truth in the globalized world. The teaching and learning of language in higher education should reflect this fact. This study suggests to integrate online technologies and cross-cultural issue in EFL classes to prepare students for future workplace. The researchers proposed to use popular mobile mediating software to increase students' motivation engaged in international context. The results of this study indicated that the use of LINE had successfully increased student willingness to communicate cross culturally in the future, as statistic result showed that both an effective cooperative learning experience between partners of different cultural groups, and the experience of synchronous communication using LINE, can successfully predict learners' future willingness to communicate cross-culturally in the future.

Hockly, N. (2013) Mobile learning. *ELT Journal* 67(1), 80-84.

Koh, M.H. & Hill, J.R. (2009) Student perceptions of group work in an online course: benefits and challenges. *Journal of Distance Education* 23(2), 69-92.

Yashima, T. (2002) Willingness to communicate in a second language: The Japanese EFL context. *The Modern Language Journal* 86(i), 54-66.

Fitzpatrick, A. & O'Dowd, R. (2012) *English at work: An analysis of case reports about English training for the 21st-century workplace*. Monterey: The International Research Foundation for English Language Education. http://www.tirfonline.org/wp-content/uploads/2012/04/TIRF_EnglishAtWork_OnePageSpread_2012.pdf

An Ecological Model for Scaling and Translation: Maximizing the impact of Research and Development Interventions

David HUNG, Longkai WU, Lung-Hsiang WONG

National Institute of Education, Nanyang Technological University, Singapore

longkai.wu@nie.edu.sg

Abstract: Scaling and translation constitutes essential challenges for educational fields. Gold standards are not possible in education because student-centered processes assume variability in different situations rather than adopting a ‘one-size fits all’ form of instruction. This paper proposes a more nuanced ecological model to describe the scaling efforts of educational innovation within the Singapore context. In this model, innovations “flourish” under different conditions with various structural supports depending on their complexity. The spreading of educational innovations from a centralized agency would be limited. Instead, teacher/researcher-led and school-led innovations would be encouraged and supported throughout the system. By going through multiple local instantiations of innovations, efficiency and cost effectively issues are addressed and teacher agency is nurtured through professional learning communities and communities of practice. System-wide baseline data is encouraged to keep tab of the growth and spread of innovations, identify gaps, and recognize areas where nudging and further supports are needed.

Keywords: Scaling and Translation, Golden Standard, Sufficing Standard

1. Introduction

The education research funding in Singapore spans two time periods (2002-2007, 2008-2012) accumulating to an approximate amount of 150 million Singapore dollars. In the first period (2002-2007), the budget from the Ministry of Education, Singapore (MOE) focused on establishing research centers at the National Institute of Education (NIE). Another goal was to change and enact new pedagogies; focusing on culturing student-centered pedagogies and participations in classrooms and beyond. In the second period, funding continued to sustain the kinds of education research populated across the Singapore education system. Research had begun to play an inevitable role in the change-reform process. These research efforts brought about various successful educational innovations, such as Group Scribbles (Chen and Looi 2011), Seamless Learning (Wong and Looi 2011), Productive Failure (Kapur 2010), in schools. These examples and many others, both from MOE and NIE, have laid the foundation for a rich and diverse culture of innovation in the schools and across the Singapore education system. Furthermore, it has also enabled the recognition of Singapore’s educational innovations amongst international research communities, practitioners, and policy makers.

With a relatively large investment on research in the last decade, the development of educational innovations in the Singapore context has reached a stage where some fundamental and pragmatic questions are raised:

- How do we “repeat” or “replicate” successful implementations of educational innovations, albeit not necessarily in identical ways, but in more economical and efficient ways?
- How can some “top down” support be provided for bottom up (researchers and teachers initiated) innovations to enable more efficiencies and cost effectiveness, and hence spread the benefits of research to other schools?

This paper proposes to address the above two questions by first arguing that the idea of “replication” is problematic to educational translation and scaling. Second, the paper proposes a way forward focused on the provision of a more nuanced ecological model, which we argue applies to

education, to describe the scaling efforts in the Singapore education landscape as exemplified by various types of existing research projects from NIE.

2. Scaling and Translation Research: From Medical to Educational Fields

2.1 Linear Modes of Scaling and Translation

In the natural sciences, including that of the medical field (see Figure 1), scaling and translation from research to everyday practices is a linear and staged process (Woolf 2009). Stage 1 of the translation research (T1) focuses on testing in laboratory settings with the aim of developing new methods for diagnosis, therapy and prevention (Woolf 2009). In T1 research, clinical scientists are working in laboratories with supportive infrastructures within the institution. This research occurs in community and ambulatory settings. The Institute of Medicine’s Clinical Research Roundtable states that stage 2 of translation research (T2) is about translating results from clinical studies into clinical practice and decision-making (Sung et al. 2003). In T2, research moves out of the laboratory into real world settings. This is the first attempt to bring T1 research to public settings. T2 research yields knowledge about efficacy of intervention in various controlled real world settings. It focuses on how infrastructure, resource constraints, human behavior, and organizational issues affect the efficacy of interventions. It recognizes that translating interventions is a socially complex phenomenon. Stage 3 of translation research (T3) is about disseminating the intervention from controlled real world settings to the general population. In T3, researchers explore ways to apply recommendations into everyday practices (Westfall, Mold, and Fagnan 2007). The focus here is on how interventions work in real world settings. Medical research, as described from the stages, moved linearly from the laboratory to the mass market. The default model is to look for a ‘gold standard’ of an innovation and bring this through the T1, T2, and T3 processes. This dominant thinking is also found in programs such as the i3 (Innovation through Institutional Integration) model of the National Science Foundation (NSF) (The National Science Foundation 2006). See Figure 1.

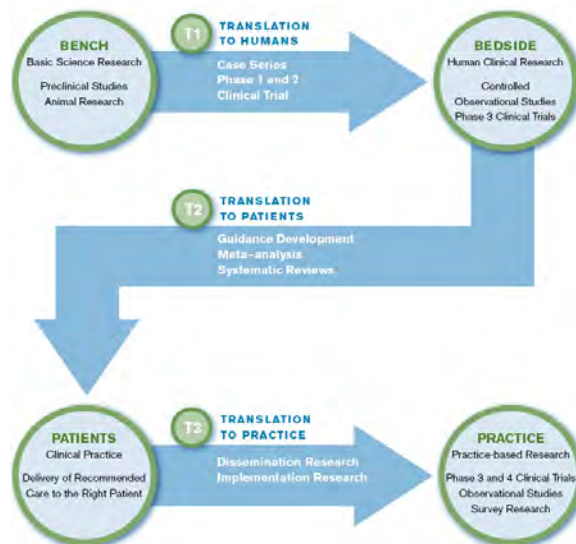

Figure 1. Linear translation model in medical research (University of Miami, 2013).

Linear models that assume replicating a gold standard are challenged for their appropriateness in education. Different educational studies discuss what “scaling” means and what it entails (see for instance, Klinger et.al, 2013; Fullan 2000; Coburn 2003; Hargreaves and Fink 2000; Bocconi, Kamylyis and Punie 2013). On the surface, scaling as defined in education seems to bear some resemblance to the medical sciences -- scaling is about diffusing an innovation from one context to the masses (Klinger et al. 2013; Sternberg et al. 2006).

2.2 *Variability Due to Student-centeredness*

Scaling and spreading innovations in education is different from the medical field. In education, the focus is on cultivating student-centered process-in-learning such as inquiry and knowledge building. Student-centered processes thus assume variability in different situations rather than to adopt a ‘one-size fits all’ form of instruction. Based on this assumption, we posit that attempts to scale, if consistent to student-centeredness, should not be mere replication from the original intervention, but variations should be allowed to occur based on differences in student profiles, curriculum, teacher dispositions, and others. To maintain the integrity and identity of the innovation, however, there should be core design principles or core fundamentals that should be upheld.

2.3 *Educational Settings are Socially Messy and Tacit Knowledge is Needed*

In medicine, research starts in laboratories in a context vastly different from the real world when a successful product will be consumed. Transfer of innovations to everyday practices is fixed on a set of procedures. In educational science, the social context is more complicated (Clarke and Dede 2009), and hence socially messy. The education environment is varied and learning is a socio-cultural process (Beach 1999). This necessitates tacit knowledge due to the dynamic interactions between teachers, students, and the situated context where the learning and instruction arises. This is in essence the student-centeredness which MOE is advocating.

2.4 *Educational Models of Scaling are Lacking from a Systemic Perspective*

Current literature discusses on issues about scaling educational innovation and possible ways to address them (Elmore 1996; Bodilly et al. 2004; Clarke and Dede 2009; Klinger et al. 2013). These discussions mostly take the respective innovation or project as the focus. Although they provide detailed accounts about scaling individual local level innovations, this level of analysis lacks the bird-eye or systems’ view of scaling. Understanding scaling at the systems’ level is essential to inform policymakers of different scaling patterns, help policymakers understand teachers’ and students’ needs on the ground, and allocate resources more efficiently.

Policy makers, practitioners, researchers, and other educational related agencies are, however, largely uninformed about how effective innovations can be made more widespread. A literature scan has not found profound theories or sound models for scaling up research that can accumulate into generalizable findings. The process of large-scale adoption of innovations is concerned not simply about “rubber-stamping” the same program into multiple contexts, but on empowering teachers in the design process of student centered lessons, fitting and adaption for local circumstances (Barab and Luehmann 2003), and others. There is not just one model for successful implementation - there are probably as many models as there are the unique contexts (Leusner, Ellsworth and Goe 2008).

Much greater complexity is involved when educational professionals seek to understand and improve the enactment of innovations, and take it to scale. A systemic approach is needed to spread innovations to improve student learning in design-based research by taking into account the interconnected relations between curriculum standards, curriculum materials, learning activities, formative and summative assessments, professional development practices and educational leadership (Looi, So, Toh and Chen 2011; Pea and Collins 2008), as well as taking into account the aspects of organizational learning (Spillane, Gomez and Mesler 2009).

Considerations of “scale” are a key challenge for school reform. Definitions have traditionally been focused on an innovation-oriented perspective that emphasizes the expanding number of schools reached by a reform or innovation. There are, however, complex challenges of reaching out broadly while simultaneously cultivating the depth of change necessary to support and sustain consequential change. Coburn (2003) and Dede (2006) develop a conception of scale that has four interrelated dimensions: depth, sustainability, spread, and shift in reform ownership to the teacher and the school. To elaborate:

- Depth looks at the nature of change, whether change is affected by the organization’s beliefs, whether individuals’ beliefs and thereafter practices have evolved; whether these changes are merely superficial. It is also important to consider the owner responsible for the change.

- Sustainability is about endurance; how long will the change endure; what strategies are in place to assure sustainability of the change
- Spread refers to the norms, principles, beliefs understood by greater numbers of people. It asks “How widespread is the change?”, “Who is involved in the change?”, “Who should be involved?” and “Who will benefit from the change?”
- Ownership is the attempt to shift reform ownership in terms of knowledge and authority to implementers; the schools who should ultimately “own” the process.

We see this conception of scale as focusing on the spread and reach from an innovation-oriented, local-project instantiation point of view rather than understanding reform, spread and (out)reach of an innovation from a system-wide perspective which is inherently more complex and non-linear. The above criteria is however important when considering local level interventions at respective schools.

3. Proposing an Ecological Model for Scaling and Translation

3.1 Overview

In the education context of Singapore, unlike the medical model, the path towards a greater adoption of educational innovation is complex and cannot be assumed to be linear. Instead we envision a model where various types of innovations (see Figure 2 below) happen concurrently. These innovations “flourish” under different conditions with various structural supports. There is a need to acknowledge that innovations have varying levels of complexities. Innovations that can more easily spread and scale would be those that have an established and socially accepted core kernel design. When such innovations are implemented in different situations, the resources well disseminated, and a sociality of teachers built around it (such as through professional learning communities and communities of practice), we can expect more of such innovations to be taken up by teachers for implementation in their classrooms. There are currently a considerable number of teacher-led projects populated throughout the Singapore education system. Some of these projects have been more successful in spreading across different classrooms and moving towards a school-oriented innovation while others have been less successful. This could be due to the complexity of the innovation and the readiness of teachers. Examples of these teacher-led projects can be found in MOE-NIE initiatives such as eduLab. eduLab is designed to surface and push ground-up Information and Communication Technology (ICT)-enriched pedagogical innovations across schools (eduLab 2009).

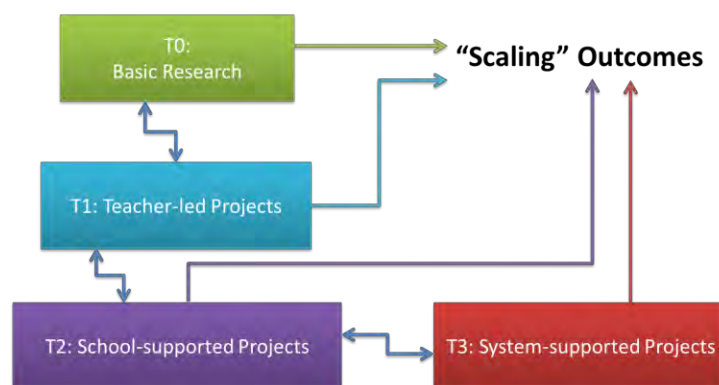

Figure 2. An Ecological Model for Scaling and Translation.

MOE and NIE stand ready to engage teachers to spread these teacher-led innovations. We envisage that innovations that are less complex would require less support. To a certain extent, if the sociality built around the innovation is strong, the innovation could continue to grow. Of course, if school-based supports are given, the spreading could happen more quickly at the school-wide and across-school levels. We refer to these as school-led or school-supported projects (see Figure 2). MOE and NIE also recognize that more complex innovations could require higher levels of support to enable it to spread. Such innovations would require the commitment of schools and principals to rally school-based support from more teachers and to make resources available in order to better support

such innovations to grow. Likewise, school principals who opt to undertake these more challenging innovations will be supported and partnered with NIE researchers (in specific instances). Given the more complex nature of these projects, a richer partnership is envisaged.

Another kind of innovation could be for projects that grew from teacher-levels or school-levels to system-wide levels. Or when MOE initiates certain system-wide projects or initiatives due to the need to regulate local level initiatives or when certain reforms are needed due to a systems' view to narrow gaps in achievement. We thus propose that instead of viewing T1, T2, and T3 as stages to be enacted linearly, we reframe:

- *T1 as Teacher-led;*
- *T2 as School-led; and*
- *T3 as System-led.*

Teachers and researchers can also take a theoretical basis (T0) and work around it in classroom (or equivalent) settings and these become T1 projects. All three types of innovations happen concurrently for a healthy ecology to occur. Growth and spread of innovations happen locally and the state of play can be understood according to Coburn's (2003) and Dede's (2006) frameworks and criteria.

3.2 Organic and Evolutionary Growth

With the three types of innovations (Teacher-, School-, and System- led innovations) populated across the system, we envisage that as teachers and schools adopt, adapt and implement innovations (with MOE's continued support and other school-based structures), local cultures of innovation would be nurtured. Due to the complexity of innovations and the nature of support required, it would be reasonable to assume that our education landscape would be one which is populated with more teacher-led (T1) and school-led (T2) innovations instead of system-led initiatives, especially in the milieu of student-centered pedagogies. The more radical and complex the innovation compared to conventional practices, the greater the need for local instantiation and spread in order to develop and cultivate the tacit knowledge underpinnings of the innovation.

As change, growth, and eventual impact of innovations to the community would be gradual, an evolutionary rather than a radical change process should be expected. With this organic approach, teachers and schools can begin the scaling-adoption process at different starting points. Teacher-led or teacher-supported innovations relate to experimentations at the local (classroom) level in small instantiations. The focus of these innovations relates to the identification and contextualization of innovations to meet students' needs and address issues in classrooms, especially of student-centered pedagogies and designs. Teachers work collectively towards refining innovations, identifying the core or kernel principles, and building teaching resources that allow innovations to be implemented in classrooms. Through experimentations and consistent dialoging, teachers may begin to adapt innovations for use with their own students in different classroom contexts. Teacher-led (T1) innovations and experimentation could grow to influence more people in various local instantiations. In other words, teacher-led (T1) innovations could be scaled locally to include more subjects, classes, different student profiles, and result in eventual "promotion" to school-led (T2) status. When spreading from teacher-led to school-supported status, implementation efforts are locally driven and emerged. These innovations could subsequently be taken up by MOE and these could be provided with financial and infrastructural supports to ensure innovations' spread and sustain with greater efficiencies. As such, these efforts could eventually be system-led innovations (T3). Examples of these T3 innovations could include the leveling up of the base of core literacies in order to bridge achievement gaps or when local growth models may be too slow for certain policy priorities.

3.3 A Sufficing Standard (instead of Gold standard)

It is important to recognize that when innovations spread in these ways, we do not seek to ask if a gold standard has been achieved before allowing for the spread to occur. Instead, we seek to ask if the teachers are enthused, committed, and ready about the innovations, whether teachers are able to take innovations to their own respective classrooms (or equivalent) and implement the core or kernel ideas of that intervention. Moreover, are resources to support these subsequent take-ups available at the school, cluster, or MOE levels to support the spreading of innovations? Are school leaders willing to

support these teachers to experiment and permit possible implementation gaps to happen, if any? And are teachers able to collect evidence-based data for their experimentations to exemplify some form of rigor? We connote that the above questions are important to the issues around a sufficing standard for spreading of innovations, rather than a gold standard. Some possible indicators of spread could be the adoption of school-led innovations by other schools, an increasing community of teachers involved around an innovation, more dialogue and sharing between schools, and others.

As we further study into the various teacher- and school-led/supported innovations, we will elaborate on the sufficing standards to inform the scaling efforts at the policy and research considerations of MOE and NIE respectively.

To reiterate, the use of “sufficing” standard as opposed to “gold” standard is adopted and argued for in this paper to shift the focus away from expecting and deriving a par excellence model which can be considered ripe and optimal as a gold standard to be rolled out to the system at large.

4. System’s Level Data of the Growth and Spread of Student-Centered Innovations

In typical scaling efforts connoted by the sciences, policy makers would roll out to the whole system or nation a certain proven drug or product. In this kind of linear scaling, data would be collected on its implementation efficacies and degrees of fidelity in terms of benefits to the different user groups. Figure 3 shows the many combinations of contexts which have to be developed centrally in order to roll out an education program. LA, MA, HA in this figure represents low achieving, medium ability, and high ability students respectively. For example, the identified smaller cube in the larger cube below seeks to know how to scale curriculum in classrooms with low achieving (LA) students.

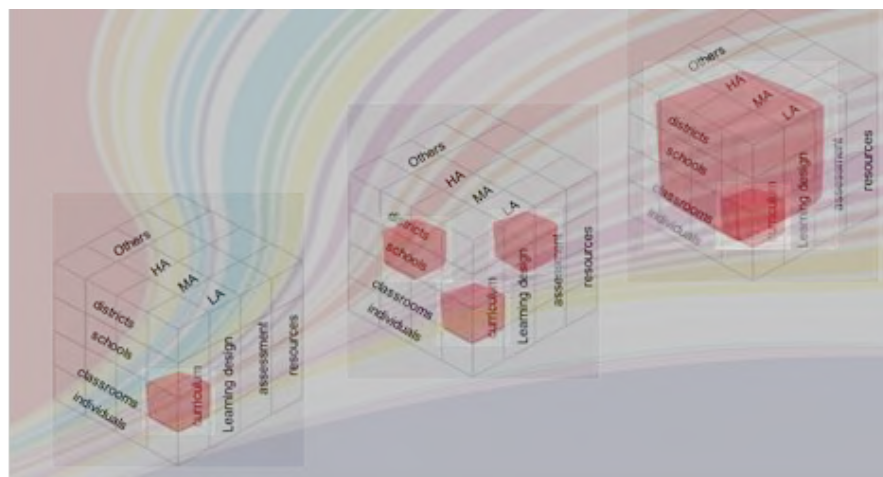

Figure 3. Contexts to consider in scaling education programs.

The concerns of policy makers are valid nevertheless. However, the strategy we are advocating in this paper is for the contextualization of pedagogy and designs to be developed and capacity of teachers to be built to enact student-centered inquiry and facilitation to be cultivated locally. Since teaching requires the interplay of tacit knowledge and developed resources, enabling teachers to have the space and time to work collaboratively with fellow teachers on crafting the lessons would be a great way forward towards fostering teacher agency and professionalism.

Nevertheless, if we were to argue for this bottom up approach of scaling with top down support (for example, from MOE), policy makers would still want to know a systems’ view of what is happening with respect to the various (reframed) T1, T2, and T3 innovations grown locally and supported at the various levels of the system. MOE would also want to know, for example, the number of schools across the system which has these innovations, the kinds of innovations and on which subject domains, the grade levels in which they have been implemented, and the local spreading that have occurred or otherwise, the number of teachers involved, the number of local teacher communities, and other such data. Data for the spread of innovations across school clusters and zones is another example of system-wide data that is useful for policy makers and NIE plays a role in providing such data.

As to data collected from 2009 to 2012, NIE’s intervention research projects have spread across Singapore in primary school, secondary schools and junior college (as shown in Figure 4 and 5). To provide a more concrete example, NIE’s research landscape has constituted an array of T1 (teacher/researcher-led) and T2 (school-led) projects (see Figure 6 below). NIE does not have system-led projects as yet. Categorizing each innovation into one of the T0/T1, T1/T2, and T2/T3 stages and allowing for natural “growth” may be sufficient to create a diverse and rich culture of innovation in our schools.

- *T0/T1 means that the researchers have worked with teachers to bring basic research ideas into the classroom, for example, Knowledge Building (Ng, Looi and Chen 2008) and Productive Failure (Kapur 2010).*
- *T1/T2 means that the classroom intervention has moved to the school level.*
- *T2/T3 means that the school’s innovation has spread to other schools (but not to the whole system)*



Figure 4. NIE’s Intervention Research in Primary Schools across Singapore in 2009 – 2012



Figure 5. NIE’s Intervention Research in Secondary Schools and Junior Colleges across Singapore in 2009 – 2012

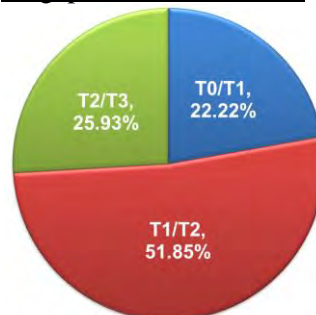

Figure 6. Distribution of NIE’s Interventions

We envisage that the data for scaling or knowing what is happening as far as scaling interventions’ attempts are concerned can be integrated with the systems’ wide baseline research

conducted by NIE and MOE in the future. When we are able to understand local phenomena and spread, we can further optimize the efficiencies and cost effectiveness such that subsequent instantiations can be done more economically, without compromising the core and kernel sufficing standards.

5. Discussions and Conclusion

Educational settings differ across classrooms and contexts. In the milieu of student-centered pedagogies and designs, the celebration of diversity in student learning and participations are desired. Hence, there is no one-size-fits-all solution for scaling. Instead, we should have a top down support for bottom up initiatives where flexibilities and adaptivities occur throughout the system with sufficing standards as largely determined by teacher readiness, leadership supports, and infrastructural adequacies at each local instantiation. While celebration of diversity is at local levels, the system keeps tab of this growth and spread of innovations with system wide baseline data in order to identify gaps, concerns where nudging is necessary for some localities, and to identify if future work and initiatives are needed.

Taking basic research to the classroom is anything less than straightforward. It involves both researchers and teachers painstakingly implementing these ideas with evidence to support their work trajectories, trailing blazing in “messy” classroom situations, till the innovation succeeds. School based professional learning communities (PLCs) and cluster-based communities of practices (CoPs) can be leveraged to monitor and mentor teachers on their teacher- and school- led pathways. researchers and their innovation/intervention projects should also be integrated into teachers’ existing PLCs and CoPs. Through these partnerships, more concerted efforts can be made to advance 21st century pedagogies and literacies throughout the system.

Policy makers should also be careful not to overly expect system roll-outs to be particularly high in fidelity and to be also concerned if perception survey results show that these schemes and initiatives are working very well. The tacit nature of educational settings requires time for interventions to take root, and for teachers to experiment and to change pedagogies. We need to also acknowledge that teachers believe in what they do, and for very good reasons, and hence change and reform take time. The system should also know the ‘good work’ that is happening at each local level before assuming that change is always for the better. Hence, the need for local and systems’ level data is imperative, going forward. Unpacking the sufficing standards at each local instantiation and supporting the spread of educational innovations would be a productive means to enable the system to optimize.

With the above instantiations, and with sufficient time, a natural and healthy state and culture of innovations across schools in Singapore will surely develop in a gradual and evolutionary manner. Policy- makers, researchers, and schools will undertake research and development efforts to further understand and implement the scaling process with a view to leveling up the base of 21st century learning and literacies, for all stakeholders, across the Singapore education system.

References

- Barab, S. L., & Luehmann, A. L. (2003). Building sustainable science curriculum: Acknowledging and accommodating local adaptation. *Science Education*, 87(4), 454-467.
- Beach, K. (1999). Consequential Transitions: A Sociocultural Expedition beyond Transfer in Education. *Review of Research in Education*, 24, 101-139.
- Bocconi, S. Kamylyis, P. & Punie, Y. (2013). Framing ICT-enabled Innovation for Learning: the case of one-to-one learning initiatives in Europe. *European Journal of Education*, 48(1), 113-130.
- Bodilly, J., Glennan Jr., T.K., Kerr, K.A., & Galegher, J.R. (2004). Introduction: Framing the Problem. In Glennan Jr., Bodilly, J., Galegher, J.R., & K.A. Kerr (Eds.), *Expanding the Reach of Education Reforms: Perspective from Leaders in the Scale-Up of Educational Interventions* (pp1-39). Santa Monica: Rand Publishing.
- Chen, W., & Looi, C. K. (2011). Active classroom participation in a Group Scribbles primary science classroom. *British Journal of Educational Technology*, 42(4), 676-686.
- Clarke, J. & Dede, C. (2009). Design for Scalability: A Case Study of the River City Curriculum. *Journal of Science Education Technology*, 18(4), 353-365.
- Coburn, C.E. (2003). Rethinking Scale: Moving Beyond Numbers to Deep and Lasting Change. *Educational Researcher*, 32(6), 3-12.

- Dede, C. (2006). Scaling up: Evolving innovations beyond ideal settings to challenging contexts of practice. In R. K. Sawyer (Ed.), *The Cambridge Handbook of Learning Sciences* (pp. 551-566): Cambridge: Cambridge University Press.
- eduLab. (2009). *eduLab*. Retrieved March 14, 2013, from <http://edulab.moe.edu.sg/cos/o.x?c=/edulab/pagetree&func=view&rid=250>
- Elmore, R.F. (1996). Getting to Scale with Good Educational Practice. *Harvard Educational Review*, 66(1), 1-26
- Fullan, M. (2000). The Return of Large-Scale Reform. *Journal of Educational Change*, 1(1), 5-27.
- Hargreaves, A., & Fink, D. (2000). The Three Dimensions of Reform. *Educational Leadership*, 57(7), 30-34.
- Kapur, M. (2010). Productive failure in mathematical problem solving. *Instructional Science*, 38(6), 523-550.
- Klinger, J.K., Boardman, A.G., McMaster, K.L. (2013). What Does It Take to Scale Up and Sustain Evidence-Based Practices?. *Exceptional Children*, 79(2), 195-211.
- Leusner, D. M., Ellsworth, J., & Goe, a. L. (2008). Scaling Up Across Diverse Contexts: Lessons Learned From Five Implementations of the Keeping Learning on Track® Program. In E. C. Wylie (Ed.), *Tight but Loose: Scaling Up Teacher Professional Development in Diverse Contexts* (pp. 105-124): ETS.
- Looi, C. K., So, H. J., Toh, Y., & Chen, W. (2011). The Singapore experience: Synergy of national policy, classroom practice and design research. *International Journal of Computer-Supported Collaborative Learning*, 6(1), 9-37.
- Ng, F. K., Looi, C. K., & Chen, W. (2008, June). Rapid collaborative knowledge building: Lessons learned from two primary science classrooms. In *Proceedings of the 8th international conference on International conference for the learning sciences-Volume 2* (pp. 115-123). International Society of the Learning Sciences.
- Pea, R., & Collins, A. (2008). Learning how to do science education: Four waves of reform. In Y. Kali, M. C. Linn & J. E. Roseman (Eds.), *Designing coherent science education*. New York: Teachers College Press.
- Spillane, J. P., Gomez, L., & Mesler, L. (2009). School Organization and Policy: Implementation, Organizational Resources, and School Work Practice. In D. Plank, G. Sykes & B. Schneider (Eds.), *Handbook of Education Policy Research* (pp. 409-425): Lawrence Erlbaum.
- Sternberg, R.J., Birney, D., Jarvin, L., Kirlik, A., Stemler, S., & Grigorenko, E.L. (2006). From Molehill to Mountain: The Process of Scaling Up Educational Interventions (Firsthand Experience Upscaling the Theory of Successful Intelligence). In M.A. Constan & R.J. Sternberg (Eds.), *Translating Theory and Research into Educational Practice – Developments in Content Domains, Large-Scale Reform, and Intellectual Capacity* (pp. 205-222). Mahwah, New Jersey: Routledge.
- Sung, N.S., Crowley, W.F Jr., Genel, M., et al. (2003). Central challenges facing the national clinical research enterprise. *The Journal of the American Medical Association*, 289(10), 1278-1287.
- The National Science Foundation. (2006). Innovative Technology Experiences for Students and Teachers (ITEST). Retrieved 22nd March, 2013, from <http://www.nsf.gov/pubs/2009/nsf09506/nsf09506.htm>
- University of Miami. (2013). University of Miami healthcare system. Retrieved from <http://mscti.med.miami.edu/program/what-is-translational-research/>
- Westfall, J.M., Mold, J., & Fagnan, L. (2007). Practice-based research – “blue highways” on the NIH roadmap. *The Journal of the American Medical Association*, 297(4), 403-406.
- Wong, L. H., & Looi, C. K. (2011). What seams do we remove in mobile-assisted seamless learning? A critical review of the literature. *Computers & Education*, 57(4), 2364-2381.
- Woolf, S.H. (2009). The Meaning of Translational Research and Why It Matters. *The Journal of the American Medical Association*, 299(2), 211-213.

An Educational Practice Using a Code Reading Support Environment for Understanding Nested Loop

Koichi YAMASHITA ^{a*}, Takamasa NAGAO^b, Satoru KOGURE^b, Yasuhiro NOGUCHI^c,
Tatsuhiko KONISHI^b, & Yukihiro ITOH^d

^a*Faculty of Business Design, Hamamatsu University, Japan*

^b*Graduate School of Informatics, Shizuoka University, Japan*

^c*Faculty of Informatics, Shizuoka University, Japan*

^d*Shizuoka University, Japan*

*yamasita@hm.tokoha-u.ac.jp

Abstract: In this paper, we describe a code reading support environment and a classroom practice using our system for understanding of nested loop. In our preceding work, we had practiced an exercise class in nested loop with a code reading support environment. The evaluation results suggested that students could obtain an expected learning effect roughly by using our system. However, we also found some of them had reached a learning impasse in the classroom. We tried to cope with them, based on two supporting approaches; to bridge a gap between generalization structures of program code and corresponding operations, and to make students capable of predicting the behavior of the nested loop. We extended the preceding system with some new functions according to our approaches, and practiced renewed exercise class in nested loop with our system. The evaluation results suggest that our new system has a certain correlation with understanding of nested loop.

Keywords: Education for programming, Domain world models, Learning environment for exercise, Education for informatics, Classroom practice.

1. Introduction

As an information level in our society advances, increasingly more various students need a computer programming education (Robins, Rountree, & Rountree, 2003; Pears et al., 2007). In our classroom experience, we have been attracted an attention by following three fundamental skills which novice programming students tend to feel difficult to acquire:

- F1. Nested structure; some students are hard to understand it in control flow or code description.
- F2. Generalization; some students are hard to generalize a set of concrete operations into an abstract function with some variables.
- F3. Tracing; some students are hard to grasp values of variables clearly, which is changing through each statement.

Nested loop is a learning target which novice students would stumble for the first time, because learning of that needs to understand or to acquire above all three fundamentals. Koppelman and van Dijk (2010) emphasized the importance of nested loop as one of the targets to understand the concept of abstraction. However, limited time of the course would hardly allow students to get a deep understanding of these fundamental concepts. In order to have our students learn them efficiently, we have tried to introduce learning support systems into our classroom exercise in nested loop (Kogure et al., 2013).

Generally, programming students learn algorithms, code-readings and codings in turn. We have already developed the learning support system for the code-reading stage (Kogure, Okamoto, Noguchi, Konishi, & Itoh, 2012). As in our preceding work, we assumed that learners understand programs and algorithms by having an image consisting of three fields in their minds: program-code, objects processing by the program (target domain world), and sequence of concrete operations for the target domain. Learners have to grasp the relationships and correspondences among the components in each

field there. Our preceding system supports to understand a program-code by visualizing three fields and their relationships.

In our preceding work, we practiced exercise classes in nested loop with our system and found some students had reached a learning impasse in the classroom. Based on implicit and explicit feedback from our students, we constructed two approaches to cope with the problems; to bridge a gap between generalization structures of program code and corresponding operations, and to make students capable of predicting the behavior of the nested loop by observing two characteristics in the code.

In this paper, we describe new functions incorporated to our system according to these approaches and renewed classroom practice for nested loop. The evaluation results suggest that our extended system has a certain correlation with understanding of nested loops. We describe the preceding system in Section 2, two approaches to avoid the impasse in Section 3, an overview of our extended system in Section 4, respectively. We provide an overview of our classroom practice, our controlled experiment, and evaluation result of our system in Section 5, and we conclude with a brief summary and discussion of future work in Section 6.

2. Learning Environment for Programs and Algorithms

2.1 Our Preceding Work

In our preceding work, we assumed that learners need to have a image consisting of three fields and to grasp the relationships among their components; program-code field (PF), target domain field (TDF), and operations field (OF). Under this assumption, we developed the system which supports students to understand programs. Figure 1 shows the overview of learning support environment provided by the system (hereafter called LEPA). Each of three fields is reproduced in (A), (B) and (C), respectively.

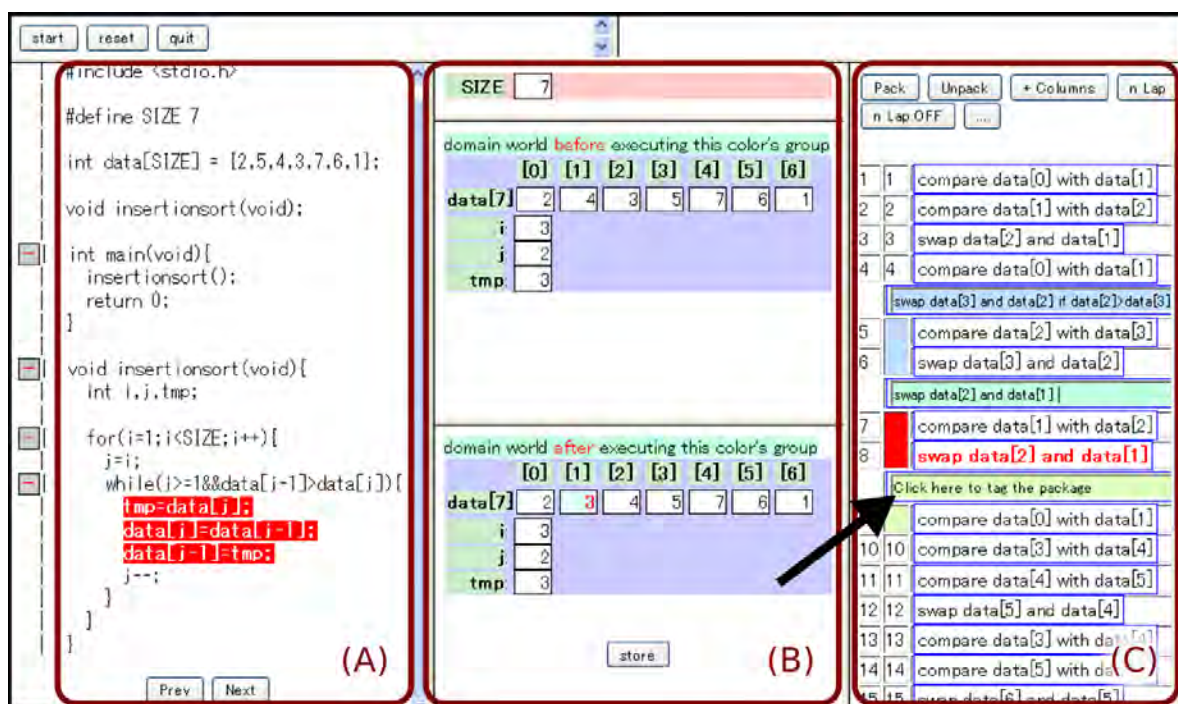

Figure 1. Overview of the environment provided by LEPA

A Learner can click one of operations in (C), so that the system displays the state of target domain after executing it in (B). S/he can know the role of a certain sequence of operations by comparing or observing visualized TDF before and after executing that. The system highlights the code fragment in (A) corresponding to the selected operation in (C), and vice versa because the system also allows him/her to click a fragment in (A). S/he can know the correspondence between a code fragment and an operation. We believe that s/he can store many pieces of intelligent information from

visualization by LEPA: what may happen in TDF by executing a concrete operation, or what kind of the code is needed to cause an effect on there.

Learning with LEPA is based on learner's externalization of his/her stored information. The externalization can be done by his/her packing and tagging process using GUI interface. If s/he found a certain sequence of operations having single abstract function in (C), then s/he could use GUI interface of the system in following two steps:

1. S/he can push “pack” button to pack the selected operations sequence into a package. Nested structure of packages is allowed.
2. S/he can tag the package with a natural language description according to its function (as in pointed part in Figure 1).

The resultant packing structure of operations sequence gets closer to the program code structure, ideally. We consider s/he will get to understand whole control sequences of the program code in the overall process of a series of these activities.

An activity of externalization can be classified into two classes according to the repetitiveness in target operations: abstraction for operations without that, generalization for ones with that. LEPA supports the former activity by the function of packing operations, and the latter by the one of tagging n -th lap of a loop (as in Figure 2).

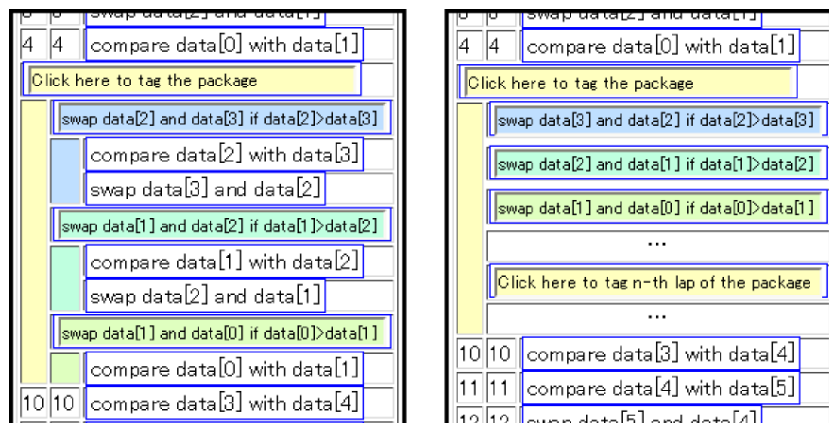

Figure 2. Tagging a package and tagging n -th lap of a package

2.2 Related Works

Shneiderman, Mayer and Heller (1977) defined a flowchart to be represented a high level definition of the solution to be implemented on a machine. Based on that, they stated flowcharting and programming can be separable independent tasks. It suggests that we may treat elaborating an algorithm and writing a program code as two separated tasks. We think that understanding an algorithm and a program code also can be separable.

So far, several intelligent tutoring systems are developed to support programming learners. They include RoboProf (Daly & Horgan, 2004), JITS (Sykes & Franek, 2003), J-LATTE (Holland, Mitrovic, & Martin, 2009), BITS (Butz, Hua, & Maguire, 2006), and so on. Several learning support systems based on algorithm visualization are also paid a lot of attention, including TRAKLA2 (Malmi et al., 2004), Jeliot3 (Moreno, Myller, Sutinen, & Ben-Ari, 2004; Ćisar, Pinter, Radosav, & Ćisar, 2011), ViLLE (Rajala, Laasko, Kaila, & Salakoski, 2008), and so on. Classifying these systems from the standpoint of the tasks understanding an algorithm and a program-code, the main target in every system seems to support either of them. Our attractive target is a gap between two tasks. We consider that these systems will provide insufficient support to bridge the gap.

Learners who have a proper understanding of an algorithm can reproduce its behavior for a concrete data. A sequence of operations in LEPA is a sequence of natural language descriptions representing the algorithm behavior. Hence, operations sequence can be regarded as an externalization of his/her understanding of the algorithm. Some other existing systems visualize relationships between a program code and its target domain world. LEPA also does it, and furthermore, relationships between a sequence of operations and its target domain. It also visualizes the correspondence relationships between a code fragment and an operation. We expect that these visualizations of three fields and

relationships among them contribute to bridging the gap between two tasks. That is why we base our approaches to bridge the gap on LEPA.

Given a program comprehension task to a programmer, his/her procedure for code reading consists of two steps normally; recognizing the function of groups of statements, and then piecing together these chunks to form ever larger chunks (Shneiderman & Mayer, 1979). S/he continues these steps hierarchically until the entire program is comprehended. LEPA has a function to support a learner to behave oneself like that in OF. Therefore, users can learn the procedure for code reading. However, if the chunk corresponds to iteration like a loop, it is often the case that his/her recognition involves generalization with some variables. As described below, LEPA supports insufficiently to generalize an iterative package.

We can find some systems targeting nested loop, including AlgoTutor (Yoo, Yoo, Seo, Dong, & Petty, 2012), the tutor developed by Dancik and Kumar (2003), and so on. However, it is not evident how they lead learners to understand or to acquire the fundamental concepts F1, F2, and F3 described in Section 1. Our works described in this paper aim to sophisticate the learning supports in LEPA by elaborating the strategy of hierarchical procedure for code reading.

3. Our Supporting Approaches

In our preceding work, we had practiced an exercise class in nested loops with LEPA. In that class, we found some of the students had reached a learning impasse. Based on the score differences between pre/post tests, the system did not have statistically significant correlation with student's ability of generalization. In this section, we describe two approaches to tackle them.

3.1 A Gap between the Representations of Generalization

Packing the operations is taking them closer structurally to the program code. However, we can find a gap between the structure of a package and corresponding fragment of program code as in Figure 3.

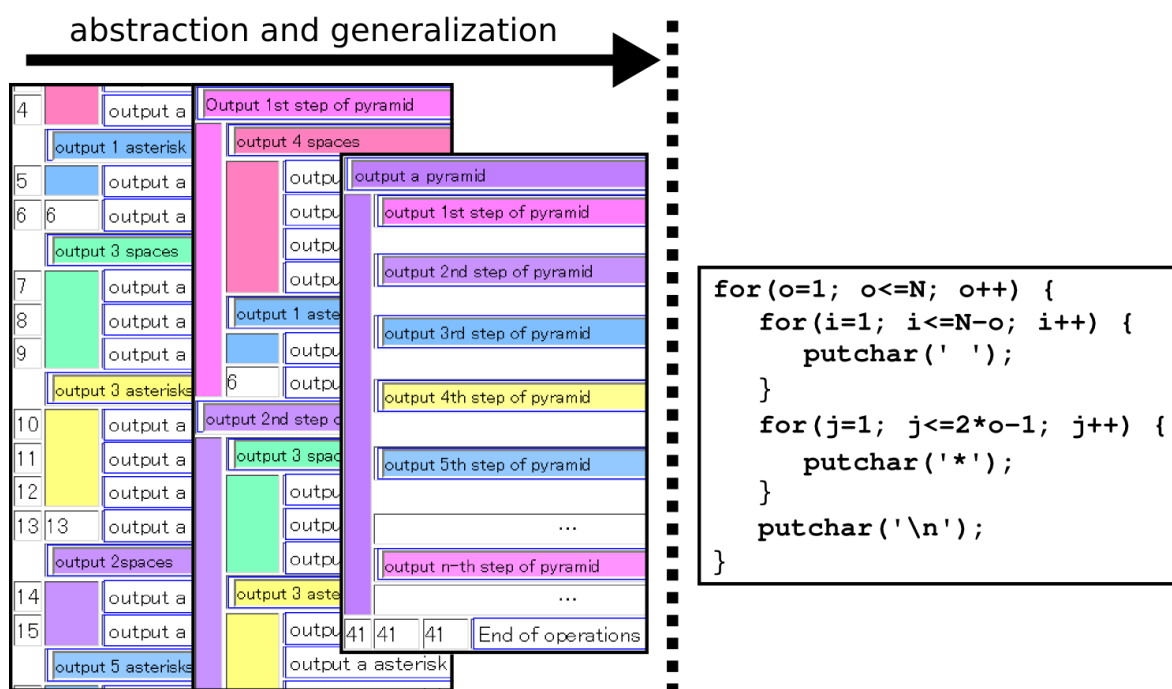

Figure 3. A gap between generalized operations and program code

The right side of Figure 3 shows a program code which displays a N -step pyramid by outputting an adequate number of spaces, asterisks, and new-lines. Other side shows a transition of the package structure corresponding to the code. This would be the most possible transition, we think.

We expect those packages are made through following steps of a student's learning: First, s/he observes three fields, and consequently makes two packages like “output x spaces” and “output y asterisks”. Here, s/he assigns concrete numerics in x and y , not variables. Then, s/he packs hierarchically them plus an operation which outputs a new-line, and tags it “output z -th step of pyramid”. z is a concrete numeric, again. S/he continues these steps until all operations in OF are included in packages. Finally s/he gets N packages, packs them, and tags n -th lap.

In LEPA, the target of a generalization tagging is the first hierarchical level only. It means that s/he tags n -th lap with a variables only on the packages “output z -th step of pyramid”. The system hides deeper levels than it in OF (outputting spaces, asterisks and new-lines). However, a program code of nested loop is given all over the hierarchy. Generalized the first level hierarchy into “output k -th step of pyramid” with variable k , then s/he should also do deeper levels as “output $N-k$ spaces” or “output $2k-1$ asterisks”. With the generalizations throughout the hierarchy, s/he should realize the meanings of control statements for nested loops in the program code.

Based on these discussions, we have implemented a function to enable users to generalize a package as keeping the hierarchy explicit, so that s/he can tag n -th lap of inner loops. In addition, we have also implemented one to generate a template of general tag automatically in following steps;

1. discriminating variable words from invariable ones in the set of tags on packages to be generalized,
2. and replacing variable ones to a series of some symbol like “_”.

For example, in displaying pyramid, our system generates templates like “output XXX spaces”, “output ??? asterisks” and “output ___th step of pyramid” from the set of tags. Proposing templates to the learner, our system encourages him/her to formulate “XXX”, “???”, “___” with loop control variables in the program code. The screenshot in Figure 4 shows the implemented functions. They are expected to lead learners to understand the structure of nested loops.

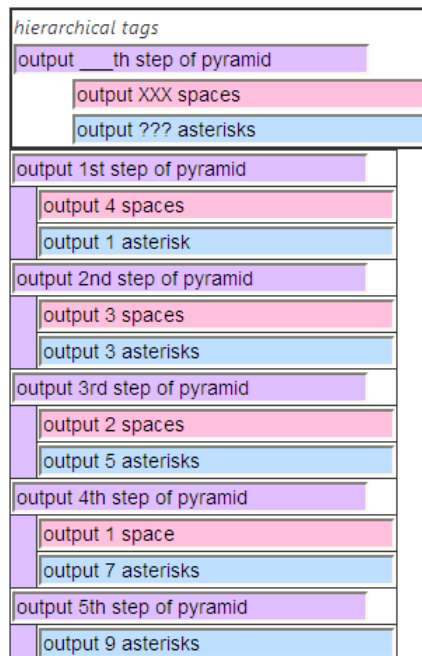

Figure 4. Generalization of packages as keeping the hierarchy explicit

3.2 Two Characteristics in Nested Loop Code

Investigating textbooks and exercises, we have classified the behaviors of nested loops learned by students into 4 types. The classification is based on following two characteristics in nested loop code:

- Ch1. A statement to iterate in inner loop has a reference to control variables of the outer loop.
- Ch2. A conditional statement of inner loop has a reference to control variables of the outer loop.

The complication of behavior of nested loop tends to grow with them, in the order of neither of them, Ch1, Ch2, and both of them. Learning these relationships between the behavior and the characteristics could enable learners to get a deep understanding of nested loop.

A programmer implements loops including not only the identical operations, but also wide variety of repetitive operations by referencing the loop control variables appropriately. For example, different values are displayed by iterative executions of the statement to display the value of variable i in a loop controlled by i . Therefore, the iteration package corresponding to the statement consists of a sequence of operations with different descriptions each other. The generalization with our system has two phases; to find operations varying regularly in an iterative package in OF, and to formulate the regularity.

A nested loop increases the diversity of repetitiveness in the corresponding operations. We have to take account of not only inner and outer loops in which their control variables are referenced respectively, but also loops with above two characteristics. A nested loop with Ch1 has operations with varying representation in each iteration step of the outer loop, that is, each inner loop. For example, left side of Figure 5 shows a program code outputting different values according to each iteration step of the outer loop. On the other hand, a nested loop with Ch2 has the different number of operations corresponding to the inner loop according to every iteration step of the outer one. For example, right side of Figure 5 shows a program code where the different number of operations corresponds to the inner loop according to every iteration step of the outer one.

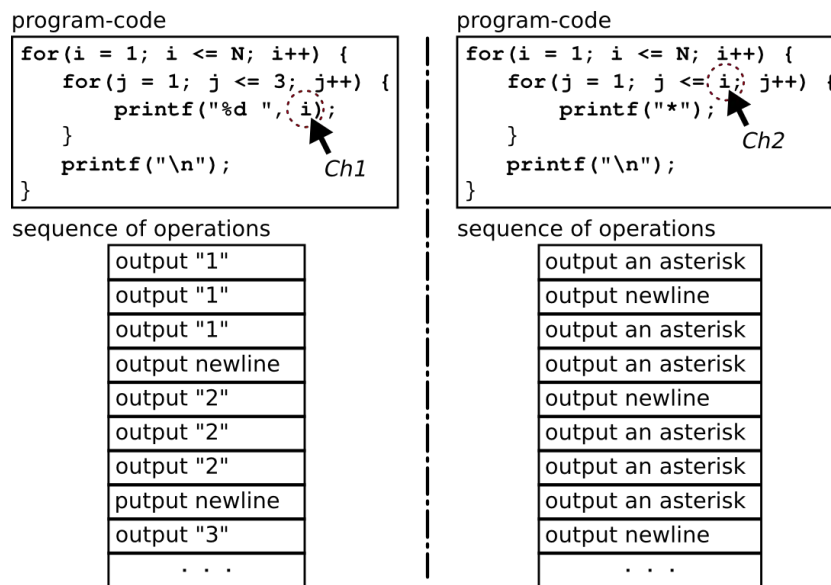

Figure 5. A program-code with Ch1/Ch2 and its operations sequence

We call the nested loops with Ch1 to “step contents varying type” of nested loops, and those with Ch2 to “step times varying type”. A learner needs to recognize the repetitiveness of the operations sequence appropriately with or without these characteristics, in his/her series of packing. Furthermore, to recognize the repetitiveness, a learner needs to anticipate the regularity in OF according to characteristics in PF.

Based on these discussions, we have planned to teach students these characteristics, aiming to allow them to cultivate a better understanding. We have also implemented another function to support to learn them, which asks for an answer to the question; which type of nested loop does the one given by our system have; step contents varying type, step times varying type, or both types? For the students who cannot answer, our system gives a following sequence of stepwise hints:

1. Hints on which part of the program-code they should focus.
2. Hints about what characteristics they should read from the focusing part.
3. Characteristics that should have been read.

4. Our Extended System

4.1 Overview of Our Extended System

We show an overview of the environment provided by our extended system in Figure 6. Our system places more emphasis on supporting to learn nested loops than LEPA. Our system leads learners to learn based on following scenario of nested loop learning.

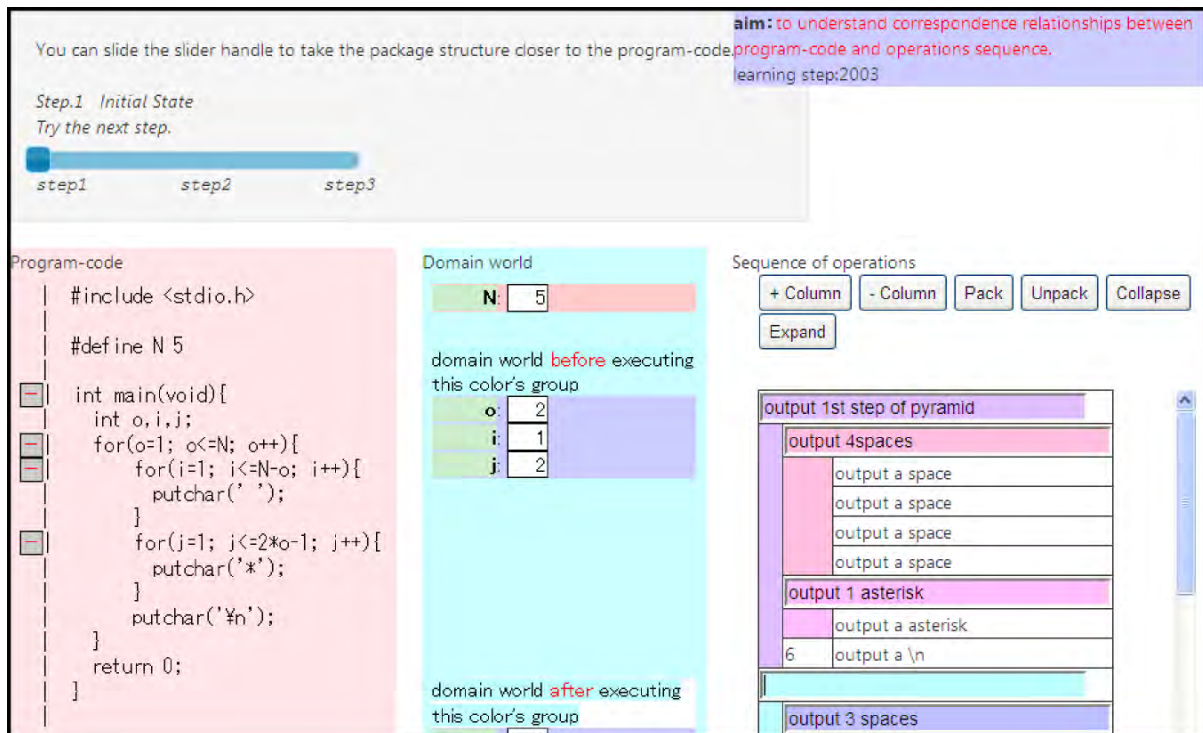

Figure 6. Overview of the environment provided by our system

- Ex1. Tracing the program code to understand the behavior and control flow over the entire program.
- Ex2. Packing the sequences of operations to recognize abstract functions and to understand the entire program as a function hierarchically.
- Ex3. Generalizing the packages of operations sequences to understand the structures of the nested loop.
- Ex4. Observing the characteristics of nested loop on the program-code to cultivate a better understanding of nested loops.

In nested loops, the repetitiveness to find in a generalization phase appears not on the concrete operations but on the tags on packages packed by the learner. We have implemented following functions to bring it to his/her attention in Ex3 above.

- Autocomplete function to support to make the repetitive packages by displaying the learner's tagging history.
- Function to support to focus on repetitive packages by setting similar tags to the same color.
- Function to support to look up a repetitiveness on the tags by hiding concrete operations.
- Function to support to tag n -th lap appropriately by providing the template of generalization tag.

4.2 Expected Learning Effect

Preceding educational practice suggests that learning with the environment visualizing three fields and relationships among them has a rough correlation with understanding or acquiring fundamentals F1 and F3 described in Section 1. In addition to these effects, our system could bridge the gap between each representation of generalization in the program code and a sequence of operations, and could lead learners to better understandings about nested loops. Consequently, it could also lead them to understandings of F2. We have hypothesized following two learning effects of our extended system.

- Hypo1. Functions proposed in Section 3.1 could promote learner's understandings of behaviors and structures of nested loop.
- Hypo2. Functions proposed in Section 3.2 could promote learner's understandings of relationships between implementations and behaviors of nested loop.

5. Evaluation of Learning Effects Based on Educational Practice

5.1 Overview of Classroom Practice

For the purpose of verification of two hypotheses described above, we practiced two consecutive exercise classes in nested loop with our extended system. Our classes were incorporated into a series of actual classes being held in department of administration and informatics, Hamamatsu University. The department holds two courses “Programming I” and “Programming II” for second year students. Our classes were practiced in the latter. The number of attending student was 12. Each of the students is majoring in business administration and had less than a year of learning programming.

In the first class, a teacher who regularly teaches the course gave a lecture on single and nested loops in 60 minutes as refresher training. The lecture includes the characteristics of nested loop described in Section 3.2. At the end of the class, we conducted a 15 minutes pretest to judge the students' understanding level of nested loops before using our system. In the second class, we allowed the students to use our system to learn nested loop. The program for this exercise is the one that displays a 5-step pyramid with spaces, asterisks, and new-lines. Before the exercise in the class, the teacher described the aims of the exercise and the environment provided by our extended system. During the exercise, neither the teacher nor we provided help to the students in understanding the program. After the 60 minutes exercise, we conducted a 15 minutes posttest to judge the students' understanding level of nested loop after using our system. We used BB FlashBack Express 3 (available on: <http://www.bbsoftware.co.uk/BBFlashBackExpress.aspx>) for recording the screen videos of students' interactions with the environment.

The programs used in the pretest and the posttest are different; however, the questions are almost the same. Question 1 (Q1) asks the execution result expected by tracing the entire program including nested loop by hand. Question 2 (Q2) asks the code fragment in the control of the inner-loop with the execution result given, and Question 3 (Q3) asks that of the outer-loop. Question 4 (Q4) asks the characteristics of nested loops to be expected to appear on program-code, given the execution results only. Q1, Q2, and Q3 are designed to verify the Hypo1, and Q4 for the Hypo2.

For the purpose of more detailed verification of advantage of learning with our system, we conducted another controlled experiment with 5 students as the control group. They are the second year students in the same course as the experimental group, but have not attended in our practiced class. First, they were given the same lecture on loop as experimental group in 60 minutes, including the characteristics of nested loop, and then we conducted the 15 minutes pretest. Next, they did the self-study with textbooks and lecture materials, never using our system. Before the self-study, the teacher described the aim of that is to understand nested loop with an example program. The example program is the same as one in the exercise practiced. The teacher also described the direction for self-study should be based on tracing the program. After the 60 minutes self-study, we conducted the 15 minutes posttest. The pre/post test are the same as ones for the experimental group.

Table 1 shows the differences of the average score on each question between pretest and posttest of experimental and control group. We marked each question in both test as following; Q1 out of 3, Q2 out of 9, Q3 out of 3, and Q4 out of 48. A tendency can be seen in that experimental group grows the marks significantly between the pre/post test but the control one does not.

Table 1: The differences of the average score between pre/post-test

	Q1	Q2	Q3	Q4
experimental	0.83	0.75	0.50	1.50
control	1.20	0.20	-0.60	-5.70

We think that more progress in control group on Q1 is caused by the direction for their self-study provided by the teacher. They could have consumed much of their time in tracing the program. Therefore, we consider they have an advantage over experimental group whose learnings consisted of 4 stepwise exercises.

5.2 Discussion

We examined carefully footage recorded for each student of experimental group in order to analyze learning effects in more detail. Consequently, we found the interactions with the learning environment provided by our system differ significantly among each of the students. For following 4 activities, we categorized the students into those who performed the activity (positive group) and those who did not perform the activity (negative group).

A1. The student consumes enough time in tracing the program (Ex1).

A2. The student packs all the operation sequences corresponding to the inner loops and tags all the packages (Ex2).

A3. The student accepts the guidance function of outer loop generalization appropriately (Ex3).

A4. The student uses the function to support to observe the characteristics of nested loop (Ex4).

We consider these activities lead the learning effect as follows.

- A1 to be the action to understand the behavior of the entire nested loop to acquire tracing skills (F3).
- A2 to be the action to understand the step contents of the inner loops and to understand the structure of the nested loop (F1).
- A3 to be the action to understand the step contents of the outer loop and to acquire the skills to generalize concrete operations (F2).
- A4 to be the action to understand the characteristics of the nested loops and to understand the relationships between the behavior and the characteristics on the program-code.

We expect the students performed these activities to grow their marks; the student performed A1 would grow his/her mark on Q1, the one performed A2 would do that on Q2, likewise the one performed A3 and A4 would do that on Q3 and Q4, respectively.

Table 2 shows the differences of the average score on each question between pretest and posttest of positive and negative group from A1 to A4. By performing an independent t-test, if the difference between negative and positive is statistically significant progress at the level $p = 0.05$, we put an asterisk next to the number. Each positive group shows significant progress their marks on corresponding question on the whole as expected.

Table 2: The differences of the average score in positive and negative group

		Q1	Q2	Q3	Q4
A1	Positive	1.43*	1.57	1.29*	
	Negative	0.00	-0.50	-0.75	
A2	Positive	0.80	2.60*	0.60	
	Negative	1.00	-0.67	0.50	
A3	Positive	1.17	1.67	1.50*	
	Negative	0.60	-0.20	-0.60	
A4	Positive				2.63*
	Negative				-0.75

The progresses in Q1, Q2 and Q3 suggest to favor the Hypo1, and that in Q4 suggests to favor the Hypo2. Hence, the results suggest that our system has a certain correlation with the understandings about nested loops on condition that user performs the expected activities.

6. Future Work

In this paper, we described the classroom practice for understanding of nested loop and the learning support system adopted there. Nested loop is an appropriate target to learn the fundamental skills of programming. We think that learning support systems contribute to understand or acquire them efficiently and effectively.

In the preceding educational practice with LEPA, we found some of the students had reached a learning impasse. We tried to cope with them, based on two supporting approaches; to bridge a gap between generalization structures of program code and corresponding operations, and to make students capable of predicting the behavior of the nested loop by observing two characteristics in the code.

According to them, we developed the function to generalize packages as keeping the hierarchy explicit for the former, and the function to support to observe the characteristics of nested loop for the latter.

We evaluated the effect of our system added the functions above in the actual classes. We also conducted a controlled experiment with 5 students as control group to verify the advantage of learning with our system in more detail. The evaluation results based on the scores on pre/post-test suggest that learnings with our system have a certain correlation with the understandings about nested loops.

As described in (Kogure et al., 2013), we have not only intended to support learners to learn nested loop. Our goal is to construct new form of education for programming with our code reading support environment. The correlation observed in the classroom practice suggests that our system will contribute to learner's understanding or acquisition of three fundamentals; F1, F2, and F3. We plan to collect more knowledge from more practices with our system, and to enhance our system and our classes.

Acknowledgements

This study was supported by Japanese Grant-in-Aid for Scientific Research (B) 24300282.

References

- Kogure, S., Okamoto, M., Yamashita, K., Noguchi, Y., Konishi, T., & Itoh, Y. (2013). Evaluation of an algorithm and programming learning support features to program and algorithm learning support environment. *Proceedings of the 21st International Conference of Computers in Education*, 418-424.
- Kogure, S., Okamoto, M., Noguchi, Y., Konishi, T., & Itoh, Y. (2012). Adapting guidance and externalization support features to program and algorithm learning support environment. *Proceedings of the 20th International Conference of Computers in Education*, 321-323.
- Shneiderman, B., Mayer, R., McKay, D., & Heller, P. (1977). Experimental investigations of the utility of detailed flowcharts in programming. *Communications of the ACM*, 20(6), 373-381.
- Shneiderman, B. & Mayer, R. (1979). Syntactic / semantic interaction in programmer behavior: A model and experimental results. *International Journal of Computer and Information Sciences*, 8(3). 219-238.
- Robins, A., Rountree, J., & Rountree, N. (2003). Learning and Teaching Programming: A Review and Discussion. *Computer Science Education*, 13(2), 137-172.
- Pears, A., Seidman, S., Malmi, L., Mannila, L., Adams, E., Bennedsen, J., Devlin, M., & Paterson, J. (2007). A Survey of Literature on the Teaching of Introductory Programming. *ACM SIGCSE Bulletin*, 39(4), 204-223.
- Dancik, G. & Kumar, A. (2003). A Tutor for Counter-controlled Loop Concepts and Its Evaluation. *Frontiers in Education*, 1, T3C 7-12.
- Yoo, J., Yoo, S., Seo, S., Dong, Z., & Pettey, C. (2012). Can We Teach Algorithm Development Skills? *Proceedings of the 50th Annual Southeast Regional Conference*, ACM, 101-105.
- Koppelman, H. & van Dijk, B. (2010). Teaching Abstraction in Introductory Courses. *Proceedings of the 15th annual conference on Innovation and technology in computer science*, 174-178.
- Daly, C. & Horgan, J. M. (2004). An automated learning system for java programming. *IEEE Transaction on Education*, 47(1), 10-17.
- Sykes, E. R. & Franek, F. (2003). An intelligent tutoring system prototype for learning to program java. *Proceedings of the 3rd IEEE International Conference on Advanced Learning Technologies*, 485-492.
- Holland, J., Mitrovic, A., & Martin, B. (2003). J-latte: a constraint-based tutor for java. *Proceedings of the 17th International Conference on Computers in Education*. 142-146.
- Butz, C. J., Hua, S., & Maguire, R. B. (2006). A web-based Bayesian intelligent tutoring system for computer programming. *Journal of Web Intelligence and Agent Systems*, 4(1), 77-97.
- Malmi, L., Karavirta, V., Korhonen, A., Nikander, J., Seppälä, O., and Silvasti, P. (2004). Visual algorithm simulation exercise system with automatic assessment: Trakla2. *Informatics in Education*, 3(2), 267-288.
- Moreno, A., Myller, N., Sutinen, E., & Ben-Ari, M. (2004). Visualizing programs with Jeliot3. *Proceedings of the working conference on Advanced visual interfaces*, 373-376.
- Čisar, S. M., Pinter, R., Radosav, D., & Čisar, P. (2011). Effectiveness of program visualization in learning java: a case study with Jeliot3. *International Journal of Computers, Communications & Control*, 6(4), 669-682.
- Rajala, T., Laasko, M. -J., Kaila, E., and Salakoski, T. (2008). Effectiveness of program visualization: a case study with the ViLLE tool. *Journal of Information Technology Education*, 7, 15-32.

Characterizing TPACK Transformations in the Design of School-Based Pedagogical Change

Joyce Hwee Ling KOH^{a*}, Ching Sing CHAI^a

^a*National Institute of Education, Nanyang Technological University, Singapore*

Abstract: The technological pedagogical content knowledge (TPACK) framework has been accepted as a powerful framework to examine ICT integration in the classroom. However, nearly a decade of TPACK research has not documented clearly how teachers synthesize the different aspects of their existing technological, pedagogical and content knowledge into a new form of knowledge to support ICT-integrated lessons. This study unpacks how teachers and researchers who are collectively engaged in lesson design sessions by putting their existing knowledge together through talk and jointly designing new TPACK to support pedagogical change in a school-based context. The study found that to do so, TPACK transformations need to occur in the areas of pedagogy, content, and technology through iterative problem-solving. The study indicates that such kinds of design efforts are potentially very important to develop deep pedagogical understanding among teachers.

Keywords: Technological pedagogical content knowledge, design thinking, teacher professional development

1. Introduction

Information and communications technology (ICT) has been envisioned as the catalyst of pedagogical change in schools. However, empirical studies of teachers' computer use in classrooms show that ICT is predominantly being used to support information transmission (Gao, Choy, Wong, & Wu, 2009; Lim & Chai, 2008; Ward & Parr, 2010). Obviously, teachers have yet to change their pedagogical practices towards the constructivist and student-centered uses of ICT that are often associated with pedagogical change. One reason could be that teachers are drawing upon their knowledge of existing instructional repertoires whereas pedagogical change requires them to design new pedagogical practices (Hammerness et al., 2005). Teachers therefore need to develop new forms of technological pedagogical content knowledge (TPACK), or knowledge for ICT integration (Mishra & Koehler, 2006) to support these changes.

It is premised that TPACK is transformative in nature (Angeli & Valanides, 2009) and studies have found that it emerges as teachers engage in lesson design activities (Koehler, Mishra, & Yahya, 2007). During lesson design, teachers draw upon their technological knowledge, pedagogical knowledge, and content knowledge to create concrete lesson ideas that are expressions of their TPACK (Cox & Graham, 2009). Teachers' lack of design expertise has been identified as a critical barrier against their successful integration of ICT (Tsai & Chai, 2012). However, we suggest that teachers' design expertise is encapsulated in their ability to use and transform their existing TPACK as epistemic resources during lesson design. Ideas for ICT innovations can only emerge successfully when teachers are able to successfully maneuver these TPACK transformations. At present moment, there are ICT lesson design models (eg. ASSURE, Heinich, Molenda, Russell, & Smaldino, 1999) that depict the ICT lesson design processes. However, how teachers form and develop TPACK throughout lesson design is still not well understood (Cox & Graham, 2009). Though it is acknowledged that TPACK is formed through collaborative design, recent reviews did not surface any studies that unpack how the transformation of TPACK emerges through design talk (see Chai, Koh & Tsai, 2013).

This study therefore aims to characterize the kinds of TPACK transformations that take place during teachers' attempt to design new pedagogies for their existing lessons. Using content analysis, we studied a team of teachers in a Singapore primary school who were revamping their math curriculum with inquiry-based learning. Audio recordings were made of their regular design discussions across six

months and content analysis using Mishra and Koehler's (2006) TPACK framework was used to characterize how teachers transformed their TPACK as they made critical design decisions. Implications for the development of teachers' design capacities are discussed.

2. Literature Review

2.1 The TPACK Framework

The TPACK framework was proposed by Mishra and Koehler (2006) as an extension to Shulman's (1986) proposition that teachers possess a unique form of know-how termed as pedagogical content knowledge. Shulman emphasized that pedagogical content knowledge went beyond teachers' pedagogical knowledge and content knowledge. It encapsulates how teachers draw upon their knowledge of classrooms, students, and curriculum to formulate instructional activities for specific groups of students. To consider teachers' knowledge of ICT integration, Mishra and Koehler proposed that seven forms of teacher knowledge can be derived from the interconnections among technological knowledge, pedagogical knowledge, and content knowledge. These are:

1. Content Knowledge (CK) – knowledge of subject matter.
2. Technology knowledge (TK) – knowledge of various ICT tools.
3. Pedagogical knowledge – knowledge of the processes or methods of teaching.
4. Technological content knowledge (TCK) – knowledge of subject matter representation with technology.
5. Technological pedagogical knowledge (TPK) – knowledge of using technology to implement different teaching methods.
6. Pedagogical content knowledge (PCK) – knowledge of teaching methods for different types of subject matter.
7. TPACK – knowledge of using technology to implement teaching methods for different types of subject matter.

TPACK describes ICT pedagogies employed for specific lesson topics whereas TCK and TPK describe the general technologies that can be used to support different content or pedagogical areas respectively (Cox & Graham, 2009).

2.2 TPACK Transformations Through Design

Niess' (2013) study of in-service teachers' TPACK across three years suggest that they needed to first recognize an ICT tool's relevance before they were able to make the pedagogical changes to adapt, explore, and advance these tools within their school curriculums. Teachers' conception of lesson strategies, and therefore their TPACK enactment, are also influenced by school policies, day-to-day logistical concerns as well as the kinds of ICT resources available in their schools (Koh, Chai, & Tay, 2014; Porrás-Hernández & Salinas-Amescua, 2013). Such kinds of decision-making may not be adequately captured in existing ICT lesson design models. An example is ASSURE which characterizes design as having defined stages including learner analysis, statement of standards and objectives, selection of pedagogies and media, implementation, evaluation and revision (Heinich, et al., 1999). This model may not depict the reality of teachers' lesson design practices as recent studies found these processes to be iterative and emergent rather than procedural (Laurillard, 2012; Summerville & Reid-Griffin, 2008). In fact, the latter descriptions of teachers' ICT lesson design practices are closer to the processes used by designers in fields such as product design and architecture. It was found that these designers engaged in iterative rounds of "reflection-in-action" where they would tinker with ideas in order to better understand their design problems (Cross, 2001; Schön, 1983). To these designers, design is essentially a process whereby their knowledge about design problems are continually being created, refined and therefore transformed through the exploration of ideas (Lawson, 1997).

For teachers, there is evidence that they create TPACK as they design ICT lessons with respect to particular instructional problems. Analysis of graduate students and pre-service teachers' reflections

of their engagement in lesson design projects assigned during teacher education courses found that their consideration of single knowledge sources such as TK and PK were more predominant at the early stages of lesson design whereas their considerations of integrated knowledge sources such as TPK and TPACK were more predominant at the later stages of lesson design (Koehler, et al., 2007; Koh & Divaharan, 2011, 2013). The presence of the integrated sources of TPACK in teachers' reflections is a particularly important finding because this indicates teachers' ability to connect their different knowledge bases in order to create particular pedagogical uses of ICT. Mishra and Koehler (2006) remarked that these integrated sources of TPACK depict teachers' ICT integration capacities. While the studies of graduate students and pre-service teachers cited earlier do provide some insight about teachers' TPACK development, there is little detail about the design processes that enable teachers to develop the integrated forms of TPACK. Furthermore, these studies are based on design projects carried out in teacher education courses and may not be reflective of how lesson design occurs in school-based contexts. It is important to understand how teachers develop TPACK to support pedagogical change but there is a dearth of studies in this area at present moment. Correspondingly, the applicability of the TPACK framework for guiding teachers' lesson design has often been questioned (Cox & Graham, 2009).

2.3 Research Question

Considering the gaps in extant TPACK research, the following will be the research question of this study:

What kinds of TPACK transformations are needed to support a pedagogical change?

3. Methodology

3.1 Study Context

The study was carried out with a team of six teachers from a Singapore primary school. As a participant of the FutureSchools@Singapore programme, the school has a mandate to develop ICT-enabled pedagogical innovations. The team comprised of the Head of Department (HOD) of Mathematics and five other teachers who had between 5-10 years of teaching experience. Researchers from a teacher education institution and a math specialist supported the teachers in this change and participated in these discussions. In a prior analysis of their students' performance in the different math exam questions, the team felt that their students' communication of mathematical reasoning could be strengthened. As this is an important component in national examinations that students take at primary 6, the teachers wanted to help students build this important skill from primary 3. From their experiences in teaching Science, the teachers felt that an inquiry-based approach could be used because it engages students to explore and explain phenomenon. The teachers therefore chose to adapt the 5E inquiry-based approach used in their Science lessons for this purpose. In this approach, learning occurred through five phases of inquiry - Engagement, Exploration, Explanation, Elaboration and Evaluation (Bybee et al., 2006). This approach was finally integrated into the topics of number patterns, fractions, money and area and perimeter, which were topics that students had more difficulty with.

3.2 The Pedagogical Change

Prior to the integration of the 5E approach, teacher-centered pedagogies were largely used to deliver the various math topics. The design of the inquiry-based lessons was progressively developed and refined as the teachers implemented the lessons for each of the various topics throughout the school year. Generally, the 5E approach was implemented by first Engaging students with a video-based scenario of a real-world problem associated with the math concept they were going to learn. For example, to bring out the issues related to units of measurement in the topic of area and perimeter, teachers showed a scenario of two students who derived different answers for the area of the same table when it was measured using different square units. Using this as a stimulus, students constructed what they know and questions about what they wanted to know about the topic of area (i.e. the K and W portions) of their K-W-L chart. From their responses to the W portion of the K-W-L chart, students voted for four

questions that they wanted to Explore and teachers then planned lesson activities to facilitate that. After exploring the concepts, teachers planned further real-world scenarios for students to Elaborate their understanding of the concept. Students then completed the L (what they learned) portion of their K-W-L chart as an Evaluation of their learning and this was consolidated into an individual concept map for the topic. Teachers' instruction of mathematical concepts as well as the worksheets and exercises typically used in these topics were integrated where appropriate.

The students were each equipped with a mobile phone that had apps enabling them to take photos, make sketches, draw concept maps as well as do postings on the school's learning management system. These features of the phone were used to support students in the activities for Explore and Elaborate as they used multi-modal formats to express their understandings of mathematical concepts. Besides the phone, teachers also used the discussion forum on the school's learning management system to share and consolidate students' work. The teachers chose a mid-ability class comprising of 43 students to pilot-test these approaches. It was envisioned that these lessons will be implemented throughout the primary 3 classes during the following school year.

3.3 Data Collection and Analysis

Data was collected during the design meetings that teachers held from July to November 2013 where they discussed lesson ideas, drafted lesson plans and resources as well as reviewed video recordings of implemented lessons to make improvement. A total of ten audio recordings were made of these meetings that lasted between 1.5 to two hours each. The recordings were transcribed into text and further broken down by sentence as the unit of analysis. To answer the research question, content analysis (Weber, 1990) was used to code each sentence according to the seven TPACK constructs. During data coding, it was found that a second layer of codes explicating how the team shared, clarified, and justified ideas was needed to explicate the stage-by-stage TPACK transformations. Smith (1994) described these as group-mediated cognition to create and extend knowledge. To ascertain the reliability of coding and credibility of data analysis, a second rater reviewed the initial coding and discrepancies were negotiated till there was full agreement.

4. Findings

4.1 Pedagogical-related Transformations

To support the pedagogical change, teachers had to first transform their knowledge of pedagogical approaches for teaching math (PCK) and their pedagogical knowledge (PK). In the initial stages of the project, teachers were confronted with the need to create their own understandings of the 5E inquiry stages as the framework's application in science may not be directly transferable to math. For example, in this discussion, teachers and a researcher discussed how to differentiate the "Explain" and "Elaborate" stages of the 5E inquiry process as they reviewed the design of a lesson activity (See Table 1).

Table 1 – Pedagogical-related Transformations

Transcript	TPACK Transformations
1. Researcher a. In these two activities where the students need to make explanations, where does Explain stop and where does Elaborate start? b. What is your definition?	PK (Clarify) PK (Clarify)
2. HOD – hmm...what is the difference?	PK (Clarify)
3. Researcher a. Does Elaborate mean that the student can explain the basic principles with more examples? b. I don't see the difference between the two activities. c. You may want to review if you need both the stages or redefine them.	PK (Clarify) PK (Identify Gap) PK (Propose New idea)

Transcript	TPACK Transformations
4. Math specialist – In science, Elaborate means that you explain the standard situation and be able to apply and extend it into different scenarios.	PK (State existing practice)
5. HOD a. For math it is a bit difficult. b. I would think [in fractions for example], Explain means that they can explain that fractions are made up of equal parts and be able to make comparisons. c. Elaborate means that if they go to the ordering of fractions, they can explain how they make the comparisons.	PCK (Identify Gap) PCK (Propose New idea) PCK (Propose New idea)
6. Teacher A a. I am thinking... can Explain mean that the students are able explain their thoughts and answers. b. Elaborate means to be able to draw conclusions from what has been discussed or to apply in a certain context.	PK (Propose New idea) PK (Propose New idea)
7. HOD – Which means they can use their explanations to extend to another situation.	PK (Refine new idea)

The above process of TPACK transformation began with the researcher seeking to clarify the team’s PK that is expressed in their design of the lesson activities (line 1a), which leads to a deeper question of possible gaps in their PK with respect to how they are envisioning the 5E stages (lines 1b, 2, 3a and 3b). The pedagogical-related transformations started in line 3c where the researcher suggested a new way of approaching this problem, which is an example of new PK. The team’s existing PK of how the Elaborate stage of 5E is being used in Science is reviewed in line 4 following which the HOD recognized a gap in their existing PCK (line 5a) and started to propose new kinds of lesson activities, which are examples of new PCK (lines 5b and 5c). Teacher A generalizes the HOD’s example as their team’s pedagogical definition, which is an example of new PK (lines 6a and 6b). The HOD further refines the PK expressed by Teacher A (line 7). Through this discussion, the team transformed their understanding of both PK and PCK to support the pedagogical aspects of their change.

4.2 Content-related Transformations

As teachers sought to deepen the students’ mathematical reasoning, they were confronted with the problem of how to better distinguish between different levels of mathematical reasoning. Teachers found that they needed to develop new Content Knowledge (CK) about mathematics. For example, for questions in fractions such as the one illustrated in Figure 1, teachers debated about the kinds of mathematical expressions that could be accepted as evidences of students’ mathematical reasoning.

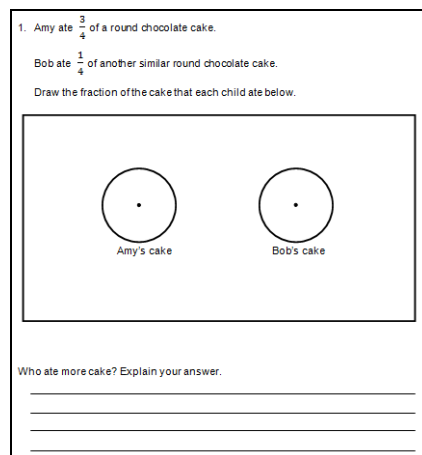

Figure 1. Sample math question on fractions.

Table 2 shows a segment of this discussion.

Table 2 – Content-related Transformations

Transcript	TPACK Transformations
1. Teacher A a. What does a correct approach mean? b. Draw and label the parts correctly? c. Eventually, are we talking about how detailed the drawing is? d. The different levels [of reasoning] have to be obvious because [the student] can draw, draw and label, or draw and label and explain	CK (Clarify) CK (Clarify) CK (Clarify) CK (New idea)
2. HOD a. Then the first level is to draw. b. Usually they (students) will shade. c. That is level 1.	CK (Refine new idea) PCK (Support new idea) CK (Refine new idea)
3. Teacher A – Level 2 – draw and label all the parts.	CK (Refine new idea)
4. HOD a. This is what we want to see. b. During their Primary 2 Summative Assessment II, a lot of them didn't label.	CK (Support new idea) PCK (Support new idea)
5. Teacher C – Level 2 will then be to draw and shade and label all the parts	CK (Refine new idea)
6. HOD – The shading is not the problem – need to label.	PCK (Support new idea)
7. Teacher A – If they explain [the wrong answer correctly] ... no marks for reasoning because it is wrong.	CK (Refine new idea)
8. HOD – [What] if explanation is clear?	CK (Clarify new idea)
9. Teacher D - Zero marks – [the] concept is wrong.	CK (Refine new idea)

Content-related transformation began with Teacher A seeking to clarify the team's understanding of what it means to say that students have taken the correct approach to explicate their mathematical reasoning (lines 1a to 1c). She shares the conception of approaching the different kinds of expressions made by the student as levels (line 1d). This idea of "levels" is taken up and refined by the HOD who identifies the first level as drawing (lines 2a and 2c). She justifies her suggestion by using her knowledge of how students typically answered such kinds of math questions, which is her PCK (line 2b). The teachers and the HOD continue refining the idea by describing what they envision the different levels to be (lines 3c to 6). Along the way, the HOD supports the idea development by drawing upon her PCK of students' test performance to emphasize how it can help teachers to better target students' areas of weaknesses (lines 4b and 6). Lines 7 to 9 show the teachers refining their CK to include situations where students provide clear reasoning but had the wrong mathematical conception (lines 7 and 9).

4.3 Technological-related Transformations

In terms of technological-related transformations, Table 3 shows that it involves teachers clarifying their pedagogical conceptions of ICT use. This discussion occurred after teachers reviewed the implementation of a 5E lesson they designed to have students explore how the concept of equal parts in fractions were used in the design of national flags.

Table 3 – Technological-related Transformations

Transcript	TPACK Transformations
1. HOD a. Did we consolidate and collate their responses? b. In our initial conception, we said that they could key their responses into the portal so that they can revisit their own or their friends' answers.	TPK (Clarify) TPACK (Clarify)

Transcript	TPACK Transformations
c. Since they have so many responses, why don't they key it in somewhere? d. They can use their phone or the laptop.	TPACK (Propose New idea) TK (Propose New idea)
2. Teacher A - There were two questions on the LMS forum for them to write their points about the flags.	TPACK (Clarify)
3. HOD a. How about archiving their own responses? b. How about a GoogleDoc for each group? c. It will be good to record their own learning, consolidate and share with their friends.	TPACK (Clarify) TPACK (Refine new idea) TPACK (Support new idea)
4. Teacher B – The problem with the phone is that students cannot access shared postings ... even using GoogleDoc on the phone is quite hard	TK (Identify Gap)
5. HOD a. For certain assignments, the students can use the phone but when they consolidate their learning they can use the laptop or desktop so that it is easy for them to read. b. The forum cannot really help them to consolidate their learning. c. It just collates the postings and comments. d. They won't have an overall picture of their learning. e. When they do their concept map later, it is not easy for them to revisit [what they have learnt about the topic]	TPACK (Refine new idea) TPK (Identify Gap) TK (Identify Gap) TPK (Identify Gap) TPACK (Gap)
6. Teacher C – Is there anything that you can use to see the students' responses immediately [in class]?	TK (Identify Gap)
7. Teacher A – The Socrative app, but it does not allow posting of pictures and you can't archive the responses.	TK (Identify Gap)
8. HOD a. But that is only during the instance of posting but what I meant is that the students can [keep a] record their own learning. b. We highlighted the limitation of the phone but we can also explore beyond it.	TPACK (Refine new idea) TK (Refine new idea)
9. Researcher a. How about online stickies? b. Teachers just need to set it up and the students can access with the URL as long as teachers don't delete the canvas.	TK (Refine new idea) TK (Justify new idea)

The HOD conceptualized ICT being used to compile the students' responses to build knowledge as a community (lines 1a and 1b). These are aspects of TPK and TPACK that did not emerge in their implementation of lesson activities. She suggests new lesson ideas which are TPACK (line 1c) and proposed some tools that can be used (TK, line 1d). This idea was not picked up immediately as Teacher A clarified that they have collected the students' ideas through forum postings (line 2). The HOD reiterates that the pedagogical idea (TPACK) is to use ICT for archival of personal learning and extension of learning by accessing the ideas of their learning community (lines 3a and line 3c). Teacher B raises another issue of the limitation of the current technology for supporting this new pedagogical aim (TK, line 4). The HOD refines her conception of TPACK by asking the team to consider how different technologies can support different kinds of math activities (line 5a). She makes general comments on the weaknesses of the forum as a personal space for archival and consolidation which is an example of the team articulating TK and TPK (lines 5b-5d). She then applies this knowledge to highlight the gap when applying it to a specific lesson activity of concept mapping (TPACK, line 5e). Teachers pick up the idea of using alternative technologies and explore their TK to

determine if there are any technologies that can help the teacher compile students' responses in class (lines 6 and 7). The HOD refines her conception of ICT use (TPACK) by reminding teachers that the pedagogical aim is also for students to archive their own learning (line 8a) and reiterates that they need not limit their TK to their current ICT tools (line 8b). The researcher suggests new TK in terms of a possible ICT tool and explains its pedagogical affordances (lines 9a and 9b).

5. Discussion

The results of this study show that in school-based context, the design of pedagogical change occurs through a process whereby different forms of TPACK are being shared, clarified and extended. This is because such kinds of change tend to be what Rittel and Weber (1973) describe as wicked problems where the desired outcomes as well as the means of achieving these outcomes are not clear at the outset of the project and emerges through design. Current TPACK studies (e.g. Koehler, et al., 2007; Koh & Divaharan, 2011, 2013) describe the kinds of TPACK that teachers create at the beginning and end of ICT courses. This study extends the knowledge of TPACK creation by exemplifying how lesson ideas are progressively being created and refined. It also shows that TPACK transformations in the area of pedagogy, content, and technology are needed to support the design of pedagogical change. Even as teachers seek to make transformations in the technological aspect, it requires concurrent clarification of the pedagogical aims of the change before the role of ICT can be clearly ascertained. Correspondingly, pedagogical change can also redefine how teachers approach their current pedagogies as well as their content knowledge. The key features of TPACK transformations needed for pedagogical change are:

5.1 Problems and gaps as catalysts

From Tables 1 to 3, it can be seen that opportunities for TPACK transformation begin when the gaps of current practices are raised for clarification. These kinds of interactions set the directions for the team to approach their design of the problem solution. In design literature, designers' conception of design problems are termed as design frames and reflection-in-action occurs as designers create and re-create frames as they evolve their problem solution (Cross, 2004; Schön, 1983). The study findings show that when the team is able to accept new frames and design ideas suggested within the team, it opens up opportunities for pedagogical change to emerge.

5.2 Iterative refinement

The findings of this study show that the ideas for pedagogical change are being refined progressively and iteratively. While the process of instructional design has been described as a systematic process with defined steps (e.g. Heinich, et al., 1999), the study findings support Laurillard (2012) and Summerville and Reid-Griffin's (2008) findings that it is emergent and iterative. The findings also show that lesson design ideas become progressively clearer as its associated problems and gaps are being discussed and clarified. Therefore, the ability of team members to "spar" effectively with each other as well as the willingness to provide time for the emergence of ideas are also important elements that facilitate TPACK transformations during pedagogical change.

5.3 Building on teachers' routine expertise

It can be seen that teachers' PCK played an important role in moving the design process forward in technological, pedagogical, and content transformations. Teachers' existing knowledge of students and classrooms are being used as epistemic resources to evaluate the possible success or failure of their design ideas. These findings show that for design to be effective, teachers' routine expertise needs to be tapped. Yet, a challenge of design is how teachers can be facilitated to make epistemic leaps beyond their routine expertise (Marra, 2005).

6. Limitations and Future Research

This study is limited to a primary school and a team of six teachers who were working on a math project. As the team was working on the project centered upon the adaption of a pedagogical approach, this might have influenced the findings. Therefore, the findings still need to be verified in different kinds of pedagogical change projects as well as with teachers designing for different subject areas, as well as in secondary and higher levels.

In this study, we examined the teachers' design talk. The talk could be further verified with teachers through interviews to improve the credibility of the study. In this study, researchers and a math specialist were also involved. This could have influenced the direction of the design decisions. In future studies, an area of study would be to examine the differences in pedagogical transformations with and without the inclusion of external parties could be compared. In addition, the relationships between design talk and effectiveness of implementation could be further correlated and examined in future studies. These kinds of studies could be used to derive guidelines on how design talk for pedagogical change could be better facilitated in school-based design teams to derive the educational outcomes they desire.

7. Conclusion

Windschitl (2002) observed that when teachers are not able to achieve deep pedagogical understanding, the kinds of pedagogical change that emerge from their design are typically characterized by surface level changes. A better understanding of teachers' design talk as well as how TPACK transformations can be better facilitated in team-based settings is one way of addressing this issue. These areas are worthy of more extensive study in future studies.

Acknowledgements

This paper is based on project discussions from the We Learn project supported by QUALCOMM. The methods of data analysis are developed from research project Developing teachers' Technological Pedagogical Content Knowledge for 21st Century Learning (TPACK-21CL) Through Design Thinking (OER5/13/KHL), funded by the Education Research Funding Programme, National Institute of Education(NIE), Nanyang Technological University, Singapore. The views expressed in this paper are the authors' and do not necessarily represent the views of NIE.

References

- Angeli, C., & Valanides, N. (2009). Epistemological and methodological issues for the conceptualization, development, and assessment of ICT-TPCK: Advances in technological pedagogical content knowledge (TPCK). *Computers & Education*, 52(1), 154-168.
- Bybee, R., Taylor, J., Gardner, A., Van Scotter, P., Powell, J., Westbrook, A., & Landes, N. (2006). The BSCS 5E instructional model: origins, effectiveness, and applications. Colorado Springs: BSCS. *International Journal of Man-Machine Studies*, 29, 407-427.
- Cox, S., & Graham, C. R. (2009). Diagramming TPACK in Practice: Using and elaborated model of the TPACK framework to analyze and depict teacher knowledge. *TechTrends*, 53(5), 60-69.
- Cross, N. (2001). Designerly ways of knowing: design discipline versus design science. *Design issues*, 17(3), 49-55.
- Cross, N. (2004). Expertise in design: an overview. *Design Studies*, 25(5), 427-441.
- Gao, P., Choy, D., Wong, A. F. L., & Wu, J. (2009). Developing a better understanding of technology based pedagogy. *Australasian Journal of Educational Technology*, 25(5), 714-730.
- Hammerness, K., Darling-Hammond, L., Bransford, J., Berliner, D., Cochran-Smith, M., McDonald, M., & Zeichner, K. (2005). How teachers learn and develop. *Preparing teachers for a changing world: What teachers should learn and be able to do*, 358-389.
- Heinich, R., Molenda, M., Russell, J., & Smaldino, S. (1999). Instructional media and technologies for learning (6th ed., pp. 7-92). Columbus, OH: Prentice-Hall
- Koehler, M. J., Mishra, P., & Yahya, K. (2007). Tracing the development of teacher knowledge in a design seminar: Integrating content, pedagogy and technology. *Computers & Education*, 49(3), 740-762.

- Koh, J. H. L., Chai, C. S., & Tay, L. Y. (2014). TPACK-in-Action: Unpacking the Contextual Influences of Teachers' Construction of Technological Pedagogical Content Knowledge (TPACK). *Computers & Education*, 78, 1-10.
- Koh, J. H. L., & Divaharan, S. (2011). Developing pre-service teachers' technology integration expertise through the TPACK-Developing Instructional Model. *Journal of Educational Computing Research*, 44(1), 35-58.
- Koh, J. H. L., & Divaharan, S. (2013). Towards a TPACK-fostering ICT instructional process for teachers: Lessons from the implementation of interactive whiteboard instruction. *Australasian Journal of Educational Technology*, 29(2).
- Laurillard, D. (2012). *Teaching as a Design Science: Building Pedagogical Patterns for Learning and Technology*. New York, NY: Routledge.
- Lawson, B. (1997). *How designers think: the design process demystified*: Architectural Press, Oxford.
- Lim, C. P., & Chai, C. S. (2008). Teachers' pedagogical beliefs and their planning and conduct of computer-mediated classroom lessons. *British Journal of Educational Technology*, 39(5), 807-828.
- Marra, R. (2005). Teacher beliefs: The impact of the design of constructivist learning environments on instructor epistemologies. *Learning Environments Research*, 8(2), 135-155.
- Mishra, P., & Koehler, M. J. (2006). Technological Pedagogical Content Knowledge: A Framework for Teacher Knowledge. *Teachers College Record*, 108(6), 1017-1054.
- Niess, M. L. (2013). Central Component Descriptors for Levels of Technological Pedagogical Content Knowledge. *Journal of Educational Computing Research*, 48(2), 173-198.
- Porras-Hernández, L. H., & Salinas-Amescua, B. (2013). Strengthening TPACK: A Broader Notion of Context and the Use of Teacher's Narratives to Reveal Knowledge Construction. *Journal of Educational Computing Research*, 48(2), 223-244.
- Rittel, H. W. J., & Webber, M. M. (1973). Dilemmas in a general theory of planning. *Policy sciences*, 4(2), 155-169.
- Schön, D. A. (1983). *The reflective practitioner: How professionals think in action*: Basic books.
- Shulman, L. S. (1986). Those who understand: Knowledge growth in teaching. *Educational Researcher*, 15(2), 4-14.
- Smith, J. B. (1994). *Collective intelligence in computer-based collaboration*. Hillsdale, NJ: Lawrence Erlbaum Associates.
- Summerville, J., & Reid-Griffin, A. (2008). Technology integration and instructional design. *TechTrends*, 52(5), 45-51.
- Tsai, C. C., & Chai, C. S. (2012). The "third"-order barrier for technology-integration instruction: Implications for teacher education. *Building the ICT capacity of the next generation of teachers in Asia. Australasian Journal of Educational Technology*, 28, 1057-1060.
- Ward, L., & Parr, J. M. (2010). Revisiting and reframing use: Implications for the integration of ICT. *Computers & Education*, 54(1), 113-122.
- Weber, R. P. (1990). *Basic content analysis*. Newbury Park, California: SAGE Publications.
- Windschitl, M. (2002). Framing constructivism in practice as the negotiation of dilemmas: An analysis of the conceptual, pedagogical, cultural, and political challenges facing teachers. *Review of Educational Research*, 72(2), 131-175.

Professional Development of Teachers in a MOOC

Niklas KARLSSON^{a*}, Anna-Lena GODHE^b, Linda BRADLEY^c & Berner LINDSTRÖM^d

^a*Department of Applied Information Technology, University of Gothenburg, Sweden*

^b*Department of Applied Information Technology, University of Gothenburg, Sweden*

^c*Department of Applied Information Technology, Chalmers University of Technology, Sweden*

^d*Department of Applied Information Technology, University of Gothenburg, Sweden*

*niklas.karlsson@bioenv.gu.se

Abstract: In this paper, we describe the participation in a MOOC which was arranged by and for teachers in Sweden. The MOOC was organized as a community rather than a course, which meant that there was a skeletal structure to facilitate community engagement but no set learning goals or tasks that had to be done by the participants. This loose structure enables participants to attend to the MOOC in different ways. Based on answers to surveys, four ways of participation are mapped out in this article. The structure of the MOOC was based on connectivist notions of knowledge building and the central principals of autonomy, diversity, openness and interactivity. How connectivist thinking can be related to the participation in the MOOC is explored and tensions between the two are discussed. The importance of dialogue in order to develop connections for learning is an aspect which is regarded as important in this article. As professional development for teachers, the MOOC has both advantages and disadvantages. The openness of the MOOC is considered an advantage by some participants, but an obstacle by others. The openness means a flexibility of when and to what extent to participate, but it also creates an uncertainty of what is expected and how to participate.

Keywords: MOOC, professional development, participation

1. Introduction

In recent years MOOCs have captured the attention as a new way of gaining knowledge and competencies, and they have been portrayed both as a threat and an opportunity to conventional education (e.g. Beaven, 2013). This article concerns a recently held MOOC in Sweden which aimed to raise teachers' digital and social media competencies.

During the autumn of 2013 *Digitala skollyftet*, was created as a cMOOC, based on the philosophy of connectivism and networking (cf. Siemens, 2005; Downes, 2008) designed by and for teachers. Four teachers, who have previously been involved in another initiative called *Skollyftet* in Sweden, set up the site and planned for the MOOC which started in November 2013. Setting up *Digitala skollyftet* can be seen as an attempt by the teachers behind *Skollyftet* to contribute to raising the digital competence amongst teachers in Swedish schools. The project aimed at addressing three cornerstones; digital competence, sharing-is-caring and school development.

Skollyftet originates in an attempt to counteract negative media coverage of Swedish schools and attempts to emphasize positive aspects and changes in the Swedish educational system. *Skollyftet* has become quite well-known amongst teachers in Sweden. On Twitter there are several active teachers who post information and discuss school issues. Every Thursday night there is an hour-long discussion on a particular subject in what is called #skolchatt. These phenomena where teachers actively engage in social media and discuss educational issues with colleagues throughout the country have been termed the Online Community of Educators (*det Utvidgade Kollegiet*).

Digitala skollyftet was designed as a cMOOC which means that the focus was on community building and interaction (Jobe, Östlund & Svensson, 2014). Most MOOCs are xMOOCs, similar to traditional academic courses and have a clear structure with a set starting and finishing point. Since MOOCs are not very common in Sweden, particularly not cMOOCs, there was a general concern amongst the organizers that the participants may need some sort of structure to get involved.

Therefore, a starting point in November 2013 was established and weekly hangouts were arranged where different issues were discussed and “experts” were invited to take part in the discussions. *Digitala skollyftet* was constructed with a connectivist pedagogical model in mind but had a skeletal structure in order to scaffold the involvement of participants.

1.1 *Digitala skollyftet*

Around 1.500 persons enrolled in *Digitala skollyftet*. However, to enrol in a MOOC, particularly a cMOOC, does not mean committing to anything. To enrol is free and open and there are no predefined expectations for participation (McAuley et.al., 2010). Since the MOOC is open, participation is possible whether being enrolled or not. Therefore, the number of people who enrolled has little, or no, relation to the number of active participants. As McAuley, Stewart, Siement and Cormier (2010) put it “participation in a MOOC is emergent, fragmented, diffuse, and diverse” (p. 6).

Digitala skollyftet aimed to facilitate user engagement and the loose structure of the course contained suggestions of weekly tasks which the participants could engage in. For example, in the first week the task consisted of presenting yourself online and commenting on someone else’s presentation of themselves. The participants were to choose a forum in which to present themselves and they also make attempts at finding other participants in digital environments and social networks. The MOOC was based on user engagement, offering a number of online tasks in which the participants could engage actively by interacting with others, contributing with posts in digital environments and social networks such as Twitter and Facebook, as well as setting up their own blog. However, participation in a cMOOC like this does not necessarily mean actively interacting and posting, but could also consist of following the flow of events connected to the MOOC and receiving information through others by reading what they post and following discussions in different forums.

The aim of this article is to investigate the activities taking place in a MOOC designed as a space for professional development of teachers. The article will map out the nature of the interaction and what it means to participate in a space that has a clear professional focus, with a structure that aims to build a community based on the connectivist principles of autonomy, diversity, openness and interactivity.

2. Theoretical framing

The theoretical framing of this article is based on an extended notion of the connectivist perspective, where interactive dialogic practices are foregrounded. cMOOCs are often associated with connectivist perspectives on learning (e.g. Bell, 2011) and connectivist approaches to learning are frequently expressed as the ability to see connections between fields, ideas and concepts, connecting information sources (Siemens, 2005). However, Ravenscroft (2011) argues that mechanisms for maintaining connections take place through dialogue: “a pivotal role for *dialogue interaction* in meaning making and learning within networks and similar open enterprises” (p. 140). From this perspective, connectivism is suggested to have evolved having an emphasis on dialogue since networking means collaborative thinking.

To some extent, *Digitala skollyftet* resembles the MOOC Connectivism and Connective Knowledge (CCK08)¹ since both explore connectivist notions of knowledge building. In previous articles (Mackness, Mak & Williams, 2010; Mak, Williams & Mackness, 2010) the participants’ learning experiences in CCK08 have been explored in relation to the connectivist principles of autonomy, diversity, openness, and connectedness and interactivity (e.g. Downes, 2008). ‘Autonomy’ here refers to that learners are allowed a choice of where, when, how, with whom, and even what to learn. ‘Diversity’ is related to there being a diverse population in order to avoid group-thinking and ‘echo-chambers’ (McRae, 2006). ‘Openness’ concerns the free flow of information and is supposed to encourage a culture of sharing and a focus on knowledge creation (Mackness et al., 2010). ‘Connectedness’ and interactivity is considered to be what makes all this possible. Knowledge emerges as a result of connections, according to the connectivist perspective (e.g. Bell, 2011). Though

¹ The MOOC Guide: <https://sites.google.com/site/themoocguide/3-cck08---the-distributed-course>

the CCK08 contained the connectivist principles, paradoxes also arose which constrained “the possibility of having the positive experiences of autonomy, diversity, openness and connectedness/interactivity normally expected of an online network” (Mackness et al., 2010). It could therefore be put into question whether it is possible to combine the connectivist principles, which are based on online networks, to MOOCs as courses. To emphasize the network aspects, and perhaps downplay the course aspects, the organisers of *digitala skollyftet* tended to refer to the MOOC as a Massive Open Online Community, rather than Course.

To frame participatory activities, Goffman’s (1959) uses the concept of presentation of self as a tool to identify user interaction. For activities of participation, online performance has been used in investigating notions of what Goffman would label front stage and back stage activities (Hogan, 2010). However, as Hogan (ibid.) points out, Goffman’s dramaturgical approach focuses on situations which are framed in time and space. Online environments, on the other hand, are often asynchronous and less dependent on time and space. Hogan (ibid.) distinguishes between performance spaces online where actors perform with each other and exhibition spaces where artifacts will be submitted by individuals in order to show to others. This distinction will be used to identify different ways in which it is possible to participate in MOOCs like *Digitala skollyftet*.

3. Methods

The method for collecting data incorporates a number of different datasets which will be synthesized in the analysis in order to illuminate different aspects of participating in the MOOC as well as of particular aspects of it, such as badges.

The empirical data consist of three surveys as well as interviews with the organizers of the MOOC and with some participants. Open online resources, such as blogs, Twitter, and Facebook, have also been mined for data which concern *Digitala skollyftet*. For example, data have been collected from mid October 2013 until the end of March 2014 from twitter, where the hashtag #digiskol has been used. Collecting data from social media is notoriously difficult and an area of research which is still very much at an exploratory stage of how to collect and analyse data (Horst & Miller, 2012), as well as ethical aspects of how to use data (Ess, 2011).

A first survey was sent out to those who had enrolled in *Digitala skollyftet*. This survey mainly asked for basic information of the participants, such as if they were teachers and which subject they taught and at what level. 438 persons answered this initial survey and above 80% of them agreed to participate in further investigations. The background information showed that the participants represented all levels of the school system. The number of female participants greatly outnumbered the number of male participants. In this survey the respondents were also asked whether they agreed to answering more surveys, whether they agreed to be interviewed and whether they agreed to possible visits by the researchers at their workplace. In the survey it was clearly stated that interviews and visits would only be made with a small number of the participants and, even if they agreed at this point in time, they have the right to withdraw their participation at any time. A second survey, with in-depth questions regarding the participants’ use of digital technology and social media within their profession and in their spare time was sent out in the beginning of January 2014. This was a rather extensive survey which took some time to complete. A third survey was sent out in March 2014. This survey was shorter and the questions concerned the participants’ experiences of the MOOC. The questions were open-ended and therefore a qualitative approach at interpreting the answers has been taken (see Appendix 1). All in all, 66 persons answered all three surveys and 10 of these persons were also awarded the *Digitala skollyftet* open badge.

The analyses in this paper primarily concern the 66 persons who have answered the three surveys. Their answers in survey three with open ended questions have been analysed and the participants have been organized in four groups based on their answers regarding their activity in the MOOC. These four groups have been compared in order to find characteristics of participation. These characteristics are then analysed in relation to the connectivist principles of autonomy, diversity, openness and connectedness/interactivity in order to notice similarities as well as differences in how the different groups relate to these principles and to detect how the principles relate to the participation in a MOOC.

4. Findings

In this section, the findings are presented starting with some general indications in the answers from survey three (see Appendix 1). This is followed by a description of four groups of participants based on characteristics of the participation, as detected in the data. Finally, the general indications as well as the groups and their participation is analysed in relation to the four connectivist principles. This analysis aims to illuminate how these principles relate to participation in a MOOC, as well as to highlight potential paradoxes and dilemmas which become noticeable when relating the principles to participation in a MOOC.

4.1 General indications

A great majority of the participants regard *Digitala skollyftet* as a good way to develop their professional competence. Only four of the 66 participants state that they are negative towards *Digitala skollyftet*. Three of these four work at preschool-level which indicates that *Digitala skollyftet* may not have been particularly suitable for this level of the educational system. As one of them states “it is all about school, school, school”. Though being positive generally, a number of participants raise issues about working too much and working on their spare time. If partaking in *Digitala skollyftet* is considered to be part of their professional development, then these participants state that it should be done within working hours. The importance of gaining approval from their headmaster in order to get time to engage in this sort of competence development is stressed.

When asking about their use of digital tools and whether that has changed due to their engagement in *Digitala skollyftet* a majority answer that it has changed. Many mention different tools that they have discovered and/or started to use, but many also state that they have come in contact with other people and through them started using other tools. 7 persons write that it has not changed their use of digital tools at all and 13 persons state that they were already competent and frequent users and therefore their use of tools has not changed to any considerable extent. The people who appear to have changed their use of digital tools the least are a group which, on the one hand, consist of those who did not engage in *Digitala skollyftet*, and, on the other hand, a group which could be considered highly competent users already. Those who benefit the most therefore seem to be a group in the middle who actively engaged in *Digitala skollyftet* and who had some experience in using digital tools but who could not be considered expert users.

A majority of the participants state that engaging in *Digitala skollyftet* has made a positive difference to developing their network. A handful write that they cannot tell, since they did not participated to any large extent and the same number say that *Digitala skollyftet* has not developed their network. Two of these participants, question the use of Facebook and Twitter and consider participation in *Digitala Skollyftet* to be too dependent on these specific environments.

When it comes to whether their engagement in *Digitala Skollyftet* has contributed to school development, more than 10 persons are uncertain or write that it has not. One of them writes that it is difficult to know since school development is a long term process. Sharing the information they received through *Digitala Skollyftet*, as well as being able to convince their headmaster of the importance of digital competence, are ways that are stated as contributing to school development. There appears to be a difference in the way school development is conceived. Some participants see their individual development as school development, or whereas others regard school development as referring to a more systemic level of the organization.

A majority of the participants say that they share material and for many that was something which they did before *Digitala Skollyftet*, so therefore their attitudes towards sharing have not changed. However, some write that they now dare to share or that they are starting to consider it. One person state that sharing makes the work as a teacher more fun as the climate at his/her workplace is “rather heavy”. Another one found it hard to find teachers who shared online and who worked at the same level in the educational system, therefore it was hard to find relevant material and/or people to cooperate with.

More than ten participants state that their engagement in *Digitala Skollyftet* has contributed very little, or not at all, to changing how they work in the classroom. Most of them state that this is because they did not engage in *Digitala Skollyftet* as much as they had planned, but some also write that they are planning to change things but have not yet done so. The changes mentioned mainly relate to the increased use of different digital tools.

Most of the participants see the openness of *Digitala Skollyftet* as something positive which enables them to engage in the MOOC when they have time and at their level. However, this could also be negative since other engagements may be prioritized when there are no deadlines to met. The openness also lead to insecurity about what you were expected to do and how. Some point out the difficulty in grasping the extent of *Digitala Skollyftet*. A couple of people state that it was hard to find people to collaborate with and one mentions that it appears as though the cooperation mainly takes place within previously existing networks. It is also mentioned that more support may be needed if you are new in this type of environment. This indicates that newcomers may find it difficult to find out how and with whom to collaborate and share ideas and material. The openness then becomes a restriction.

Only a handful of people consider *Digitala Skollyftet* as finished, instead the majority view it as a start and emphasize that school development is a continual process without end. This indicates that *Digitala Skollyftet* is regarded as school development and not primarily as personal development.

4.2 Four groups of participants

Four groups have been distinguished in the empirical material based on their participation in *Digitala skollyftet*. These four groups will be presented here and the characteristics of each group will be explored and explained. The four groups are categorised as follows:

- the posting participants (21 persons),
- the on-looking participants (16 persons),
- the constrained participants (17 persons),
- the non-participants (12 persons)

The distinction between the groups are not clear-cut, particular not between the two middle groups of on-looking and constrained participants as these two groups are similar in that they have participated in *Digitala skollyftet*, but not consistently or as on-lookers. In all four groups, there are representatives from different levels of the school system. The number of males and females in the groups mirrors the larger representation of females which was found in the initial survey.

“The posting participants” is the group that portray themselves as active participants in *Digitala Skollyftet*. They have contributed to discussions in different forums and shared their material with others. Half of the group (10 people) have also been awarded a *Digitala Skollyftet*-badge. In order to receive the badge they had to give evidence of their competence in the three cornerstones; digital competence, sharing-is-caring and school development. Though this group is positive towards *Digitala Skollyftet* about half of them also raise critical issues regarding the loose structure of the course and that it was hard to grasp and understand what to do and how to perform the tasks. Some of them consider the difference in experience of the participants to be somewhat problematic. Whereas a couple of them write that they had expected a higher level on the assignments, a few others write about the obstacles for newcomers to participate in the MOOC. All but one of the participants in this group, write that they share material and ideas with others. A couple of them appear to share mainly with external colleagues since they claim not to get much response from the colleagues at their workplace. One of them writes that social media has become a breathing space, in which to communicate with equally engaged colleagues. A number of participants in this group appear to focus their involvement around certain interests such as flipped classrooms and coding. This could be a strategy to narrow the focus of participation in order to cope with the expansiveness of *Digitala Skollyftet*.

The persons in “the constrained participants” group state that they have not engaged in *Digitala Skollyftet* as much as they had liked to, or planned to do. Most of them write that they started off being active and engaged but then their everyday work as teachers took most of their time and due

to time constraints they have not participated in the way they intended. Overall this group appears to be active, though not consistently, and most of them write that they actively share material with others, though some state that they are still a bit reluctant to do that. Though they have not been as actively engaged in *Digitala Skollyftet* as they had planned, most of them still claim that they have changed their way of working in the classroom by using new or different digital tools. They also express that their network of colleagues have expanded and that they have found new persons and blogs to follow and get ideas and practical suggestions from. Some of them state that their engagement in *Digitala Skollyftet* has enabled them to support colleagues at their workplace in developing competencies regarding digital tools and sharing with others.

“The onlooking participants” are characterized by their engagement in *Digitala Skollyftet* mainly consisting of reading what others have posted in different forums and on blogs. These participants do not, to any great extent, post and share their own material and they are therefore less visible as active participants compared to those who post and share actively. In the descriptions of their engagement in *Digitala Skollyftet*, they appear to be active in the sense that they read blogs and follow Facebook-groups and discussions on Twitter. This is a source of information and inspiration, which is then shared by some with colleagues at their workplace. Some of them try out new digital tools in their classrooms and some consider their involvement in *Digitala Skollyftet* as leading to school development when they spread what they have learned through reading and following activities in different forums. When referring to the Online Community of Educators (*det Utvidgade Kollegiet*) they mainly appear to see the community as a resource. However, most of them are reluctant to share themselves, even though some say that they either do, they are starting to do it, or consider doing it. A couple of the participants in this group state that the openness enables them to participate in their own way so that even if they are not posting or actively participating in discussions, they are able to follow them in their own time.

“The non-participants” have not engaged in *Digitala Skollyftet* to any considerable extent. Half of the group, 6 persons, says that they did not participate due to changes in work or family issues. However, 4 of these express that they see *Digitala Skollyftet* as a good way to develop professionally. A couple of the others write that they did not have the necessary tools to be able to participate and two of them say that they were not allowed to participate due to lack of communication and since they did not understand what they were supposed to do, or how. This indicates that these persons belong to those who would have needed more support in order to be able to participate.

The characterizations of the different groups are based on how they portray their participation when answering the third survey. This portrayal can be compared to how they answered questions about their activity in social media in the first and second survey, as well as to their actual activity on for example Twitter during *Digitala Skollyftet*. In the first two surveys “the posting participants” and “the constrained participants” state that they are active in social media to roughly the same extent. However, their activity on Twitter convey that “the posting participants” are more active since they both post more tweets, retweet more and have a larger number of followers as well as the number they follow.

4.3 *Connectivist principles and participation in Digitala Skollyftet*

In this section the participation in *Digitala Skollyftet* will be considered in relation to the connectivist principles of autonomy, diversity, openness and connectedness/interactivity. These principles connect and influence each other and their interconnectedness is therefore in focus rather than each principle on its own. The findings in earlier studies of the CCK08 (Mackness et al., 2010, Mak et al., 2010) will be related to since both this MOOC and *Digitala Skollyftet* could be called cMOOCs.

Mackness et al. (2010) write that the participants in CCK08 equated autonomy to “flexibility and control over learning and exemplified by the participants’ choices of how, and how much, to engage with the course” (p. 269). This corresponds to a large extent to what the participants in *Digitala Skollyftet* consider to be the advantage of the MOOC. However, the participants in *Digitala Skollyftet* also saw this flexibility, together with the openness of the course, as one of the obstacles for active participation. The need for guidance was stressed by several participants and some stated that their reason for not participating was the open structure, or lack of structure and support. The openness was regarded as an obstacle since the participants became uncertain of what was expected of

them, but also as an asset since the way they participated became more flexible. Mackness et al. (2010) state that in CCK08, openness was implicitly referred to as a way of being. The participants in *Digitala Skollyftet* similarly seem to equate openness and the inclination to share as a positive personal asset which many of them claim to have or, if not, then aspire to acquire.

When it comes to diversity, this could be considered from two different aspects. Many participants stated the fact that they could connect to colleagues who worked in different environments and different parts of the country as something positive. Professional development of teachers commonly takes place within a particular school or maybe together with neighbouring schools. In that sense *Digitala Skollyftet* offers diversity. On the other hand, it is discernible in the data that many participants were mainly interested in connecting with people who in some sense were similar to themselves. To collaborate with someone it was often stated that the other person(s) needed to teach the same subject and/or teach at the same level of the school system. In that sense diversity was not something that the participants sought in *Digitala Skollyftet*. Since the MOOC was intended for teachers in Sweden it could also be argued that this group in itself is not homogenous enough to enable the kind of diversity aimed at in MOOCs. Instead, what McRae (2006) refers to as group-thinking and ‘echo-chambers’ may be encouraged.

Although the participants in *Digitala Skollyftet* consider the autonomy and flexibility of to what extent and how they engage in the MOOC as important, their actual engagement in *Digitala Skollyftet* is characterized by their interactivity with others. The importance of digital dialogues, as pointed out by Ravenscroft (2011), becomes apparent since to follow others on Twitter and on blogs is by many regarded as a key feature in their own development. The notion of “sharing-is-caring” closely relates to this interconnectedness and stresses the community, rather than the individual, as important. The activities of the participants on Twitter convey this interactivity and also explicate the importance of certain actors. The organisers of *Digitala Skollyftet* are central in these activities as many of the participants turn to them when they have questions, but also since they to a certain extent moderate the course by supporting participants in different ways. For example, they retweet when somebody asks a question or enquires about possible cooperation, or they attempt to put people in touch with each other who have not yet “connected” on Twitter. Figures 1-4 attempt to visualize the network of participants from the different groups². The visualizations depict the activity on Twitter under the hashtag #digiskol during the period of October 2013 to March 2014. Figure 1 shows the network of the non-active participants (marked with red). As shown, these participants have few contacts. Some are in contact with the organizers (marked with turquoise) and also with the Twitter alias @digiskol and @skollyftet (marked with blue). The activity of the on-lookers is depicted in figure 2. The on-lookers (marked with yellow) are connected to each other through their contact with the organisers as well as through @digiskol and @skollyftet. The amount of contacts varies and so do their connectedness to others in the group. Figure 3 shows the activity of the constrained participants. Their networks are intertwined through the interaction with the organizers, @digiskol and @skollyftet. Some of the on-lookers appear to have more contacts than the constrained participants. This could be because the on-lookers mainly collect information and in order to receive a substantial amount of information they have a larger network. The posting participants have vaster networks than the other three groups, as shown in figure 4 (marked with green). However, in all the groups, the organisers, @digiskol and @skollyftet are important nodes in the networks.

Apart from the organisers, other experienced users of Twitter with large networks of followers may become important to newcomers. In this way some participants may take on, or be given, the role of an expert. Though the building of a community of peers may be the vision of a MOOC, the reality may be that the occurrence of more-capable peers in networks are inevitable. However, this should not be seen as negative, but rather as a way in which participants learn from

² The size of the circles in the figures visualizes the amount of interaction, as in mentions, sent to and from participants. Larger circles mean that a larger amount of tweets with mentions have been sent. The sizes of the circles should be considered within each figure as the scale of the figures had to be adjusted so that all became visible but were not too large.

The size of the arrows in the figures relates to the number of tweets with mentions. The alias where the arrow originates from has sent a mention to the alias which the arrow points to. An arrow pointing at a circle means that tweets have been sent which mentions the alias of this circle.

each other and where more-capable peers can be regarded as assets since they may scaffold the experiences of the newcomers.

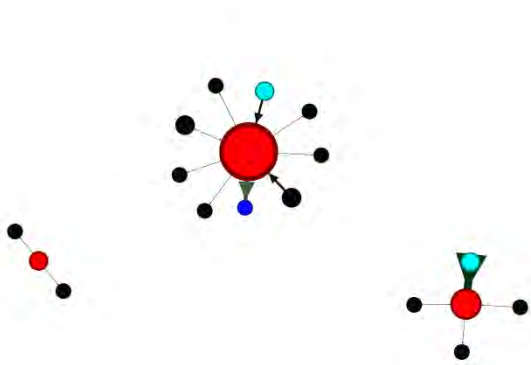

Figure 1 Non-participants

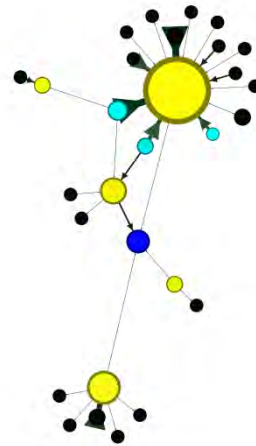

Figure 2 On-looking participants

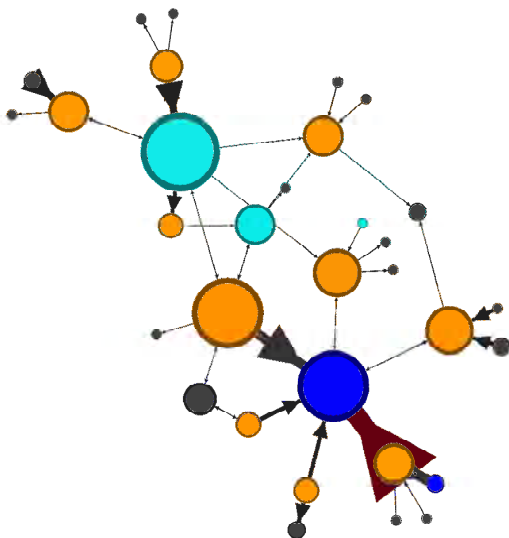

Figure 3 Constrained participants

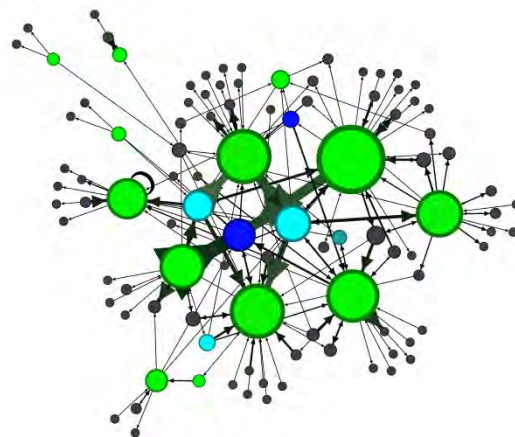

Figure 4 Posting participants

According to connectivist views, learning flows from an initial connection (e.g. Siemens, 2005). However, as pointed out by Mackness et al. (2010) “connectivity itself is not a sufficient condition for connectedness or interactivity” (p. 272). To achieve meaningful connectedness is difficult and this difficulty may partly be related to the relation between a MOOC and the connectivist principles (ibid.). To connect digitally with others is one thing, but in order to investigate how these connections may evolve and become spaces for learning, attention needs to be paid to the dialogues that the connections facilitate (Ravenscroft, 2011).

5. Conclusion

To sum up, it is possible to see that the *Digitala skollyftet* is an active environment, displaying interaction on different levels. Four categories of participation were discerned, which all show ways

of engaging in this type of MOOC. *Digitala skollyftet* can be considered as professional development for teachers. The different ways of participating in the MOOC disclose that the openness of the MOOC is both an obstacle and an asset. Posting participants, who generally are experienced users of social media, as well as non-participants, who generally are less experienced in digital surroundings, state that the openness contributed to an uncertainty of what was expected of them when taking part in the *Digitala skollyftet*. That it was difficult to grasp the extent of the course added to their uncertainty.

Comparing the four different groups of participants it is possible to discern differences in how and with whom they engage. The visualizations in figure 1-4 attempts to show that the extent of their networks are different. What is similar in the networks of all groups is that the organisers of the MOOC, @digiskol and @skollyftet are important nodes in the networks. The posting participants have a wider network, which, to some extent, is separate from *Digitala skollyftet*. One reason for this may be that their networks have been developed before the MOOC. For some of the constrained and on-looking participants, the building of a network started with their participation in *Digitala skollyftet* and is therefore intimately connected to the MOOC. However, the participants in these two groups also appear to closely relate their activities in the *Digitala skollyftet* to the local context of the school where they work. The importance of sharing what they have discovered through *Digitala skollyftet* with their colleagues at work is emphasized more by these groups than by the posting participants. The participation of the constrained and on-looking group may therefore contribute to the professional development of the participants as well as their local colleagues. The different groups of participants reveal different ways of engaging with the MOOC. However, whether there is a preferred way of engaging with the MOOC is, according to us, not possible to discern. Instead, how participants chose to engage in the MOOC is likely to depend on their personal reasons for participating and their professional development also relate to what they wish to achieve and in which areas. Since the MOOC is open and diversified, what participants gain from engaging in it is likely to become equally open and diversified. As cMOOCs are not supposed to have preconceived fixed goals, it is largely up to each and every participant to decide their own path. However, if learning is seen as social in nature and depends on the engagement with others, then what kind of interaction between participants the MOOC renders possible are crucial in order for spaces for learning to evolve. To facilitate the performance of qualitative interactions rather than the exhibition and sharing of artifacts, scaffolding may to a larger extent be needed in a MOOC.

The connectivist principles of autonomy, diversity, openness and connectedness/interactivity have a bearing on the way the participants engage in the MOOC. However, questions could be raised as to what extent the connectedness facilitated by the MOOC also facilitates spaces of learning. The nature of the interactions, whether analog or digital, is crucial if MOOCs are to become spaces for learning. Therefore, Ravenscroft (2011) write that connectivist' thoughts need to consider the importance of dialogue. He stresses the need for dialogues to facilitate critical inquiry, reflection and negotiation. Some of the participants in *Digitala skollyftet* stress the need to be able to further discuss issues. This appears to be done by some participants when they share their experiences in the MOOC with colleagues at the school where they work. For these participants the MOOC becomes a vehicle for finding information and sharing with others, but deeper engagements in subjects are carried out through dialogues in local contexts. This connects to Hogan's (2010) notions of performance and exhibition spaces. With the current structure, the MOOC appears to mainly facilitate the exhibition and sharing of artifacts. In order to become a performance space where participants engage with others, a structure of the MOOC which supports such dialogues may be needed. The purpose of the structure would be to facilitate deeper engagement by supporting critical inquiry, reflection and negotiation. Such a structure may overcome the difficulty to achieve meaningful connectedness (Mackness et al., 2010) since it addresses the differences between networks in general and MOOCs as networks which facilitate learning.

Acknowledgements

We would like to thank all the people who prepared and revised previous versions of this document. We would also like to thank all those who participated in the collecting of data.

References

- Beaven, A. (2013). Using MOOCs in an Academic English Course at University Level. In A. Beaven, A. Comas-Quinn, & B. Sawhill (Eds.), *Case Studies of Openness in the Language Classroom* (pp. 217-227).
- Bell, F. (2011). Connectivism: Its Place in Theory-Informed Research and Innovation in Technology Enhanced Learning. *International Review of Research in Open and Distance Learning*, 12(3), 98-118.
- Downes, S. (2008). *Connectivism: A Theory of Personal Learning*. Retrieved from: <http://www.slideshare.net/Downes/connectivism-a-theory-of-personal-learning>
- Ess, C. (2011). *Ethical dimensions of New Technology/Media*. In G., Cheney, S., May, & D., Munshi (Eds.), *The Handbook of Communication Ethics* (pp. 204-220). New York: Routledge.
- Goffman, E. (1959). *The presentation of self in everyday life*. Anchor Books, New York.
- Hogan, B. 2010. The Presentation of Self in the Age of Social Media: Distinguishing Performances and Exhibitions Online. *Bulletin of Science, Technology & Society*, 30(6), 377-386.
- Horst, H. A., & Miller, D. (2012). *Digital Anthropology*. Oxford: Berg.
- Jobe, W., Östlund, C. and Svensson, L. (2014). MOOCs for Professional Teacher Development. In M. Searson & M. Ochoa (Eds.), *Proceedings of Society for Information Technology and Teacher Education Conference 2014*. Chesapeake, VA: AACE
- Mackness, J., Mak, S.F.J., & Williams, R. (2010). The Ideals and Reality of Participating in a MOOC. *Networked Learning Conference*, Denmark.
- Mak, S.F.J., Williams, R., & Mackness, J. (2010). Blogs and Forums as Communication and Learning Tools in a MOOC. *Networked Learning Conference*, Denmark.
- McAuley, A., Stewart, B., Siemens, G., & Cormier, D. (2010). The MOOC model for digital practice. Retrieved from: http://davecormier.com/edblog/wp-content/uploads/MOOC_Final.pdf
- McRae, P. (2006). Echoing voices – emerging challenges for educational practices on the internet. In T. Reeves, & S. Yamashita (Eds.), *Proceedings of World Conference on E-Learning in Corporate, Government, Healthcare, and Higher Education* (pp. 2622-2629).
- Ravenscroft, A. (2011). Dialogue and Connectivism: A New Approach to Understanding and Promoting Dialogue-Rich Networked Learning. *International Review of Research in Open and Distance Learning*, 12(3), p. 139-160.
- Siemens, G. (2009). What is Connectivism? Week 1:CCK09. Retrieved from https://docs.google.com/document/d/14pKVP0_ILdPty6MGMJW8eQVEY1zibZ0RpQ2C0cePIgc/edit?pli=1
- Siemens, G. (2005). Connectivism: A learning theory for the digital age. *International Journal of Instructional Technology and Distance Learning*, 2(1), p. 3-10.

Appendix 1

Questions in survey 3

- How would you describe your participation in *Digitala Skollyftet*?
- In what way has your participation in *Digitala Skollyftet* contributed to changing your use of digital resources?
- In what way has your participation in *Digitala Skollyftet* contributed to the development of your network?
- In what way has your participation in *Digitala Skollyftet* contributed to school development?
- How has your participation in *Digitala Skollyftet* altered your views on sharing on the Internet?
- In what way has *Digitala Skollyftet* contributed to changes in the classroom? Please give concrete examples!
- What advantages and disadvantages do you see with this kind of “course structure”?
- How do you evaluate *Digitala Skollyftet* as professional development?
- Do you consider *Digitala Skollyftet* to be finished?
- General comments about the course

Teachers' Perceptions of E-Learning in Malaysian Secondary Schools

Mei Lick CHEOK & Su Luan WONG

Faculty of Educational Studies, University Putra Malaysia, Malaysia

Abstract: Malaysian teachers are constantly bombarded with many new technologies that are believed to be able to help them perform their job better. Since 2013, they have been given access to an online learning space known as the FROG VLE. However, initial evidence has shown poor adoption of the e-learning. As schools are becoming increasingly disconnected from the societies of which they are a part, teachers withdrawing into their old familiar landscapes of teaching and learning can no longer be accepted. Being the implementers in the classrooms, their perceptions' towards any innovation are important if the innovation is to be taken up seriously and to be implemented. Measures to improve present condition in order to sustain and increase e-learning uptake, can only be carried out if we know the situations and conditions teachers are in. A qualitative approach was used to identify the views and experiences of 60 secondary school teachers towards the implementation and continued use of VLEs in three secondary schools in Malaysia. Data was collected using an open-ended questionnaire. The results among others, share benefits experienced by the teachers, identified main barriers they faced and suggestions to better improve the implementation.

Keywords: E-learning, blended learning, perceptions, secondary school education, teachers

1. Introduction

By 2019, 50 percent of all high school courses are predicted to be delivered in an online format (Horn and Staker, 2011). Education will be revolutionised by making it more accessible and individualised (Christensen, Horn & Johnson, 2011). To keep pace with the growth of e-learning education in Malaysia, there is a pressing need to conduct relevant research in this area.

This paper presents the results of a recent study we conducted on the FROG VLE in three secondary schools from two states in Malaysia. FROG VLE is the government's initiative to leverage ICT usage in all its primary and secondary schools in the country. Previous initiative, to increase ICT usage in schools known as the Smart Schools' project despite having consumed massive expenditure, found that 80% of the teachers used ICT less than one hour per week, and this was also mostly limited to word-processing (UNESCO, 2013). Other researchers have also argued that computer usage in schools are limited and in some cases almost non-existent (Koustourakis & Panayiotakopoulos, 2008). To benefit from the latest innovation introduced in schools, early intervention programmes are needed to prevent similar poor results. Therefore, teachers' early perceptions of the FROG VLE are crucial for ongoing assessment plus intervention programmes to be carried out as problems emerged are identified and solved. In order to facilitate effective e-learning, the benefits as well as the barriers to implementation must be understood. Thus, three research questions guided this study:

1. What are the benefits of e-learning for teaching as perceived by teachers?
2. What are the barriers of e-learning implementation as perceived by teachers?
3. What suggestions do they have to improve the e-learning teaching and learning environment in schools?

The results of this study are expected to help better understand issues related to teaching and learning among the teachers when implementing e-learning in their classrooms and to provide implications for designing and delivering e-learning education and professional development courses. We believe the benefits are best articulated by those with first-hand experience using the e-learning in their classrooms. Those who have not implemented are likewise in a unique position to provide insights into the barriers that are preventing them from utilising the system. Suggestions for improving the e-learning teaching and learning were also sought in order to better understand teachers' situations. The

implications are far reaching in our understanding of the e-learning's role in supplementing and at times complimenting the face-to-face teaching and learning. The present study is part of a larger study in which factors that predict teachers' satisfaction in the e-learning environment are also studied.

2. Literature Review

2.1 Learning Management System (LMS) in Malaysia

LMS is a software package that administers education and manages human resources. It supports e-learning activities such as presenting information, managing course materials, and running assessments (Yueh & Hsu, 2008). It offers teachers a number of benefits, like having the course management tools, group chat and discussion, assignment submission, course assessments, manage educational resources and also track student's participation. Besides increasing interest among the teachers and learners, it also enhances teaching effectiveness and cost-saving (Yueh & Hsu, 2008). It provides support and enhances traditional ways of learning (Georgouli, Skalkidis & Guerreiro, 2008). Various terminologies are also used to describe the LMS, for instance Course management System (CMC), Learning Content Management System (LCMS), Computer-based Learning and Online Learning. At present there are several LMS applications in the market like Moodle, Blackboard, Etutor, eFront amongst many others.

E-learning is becoming an important long-term strategy for many educational institutions. Given the rapid growth and its importance, quality e-learning environment is highly required. The one person who would be at the forefront of the online delivery is the teacher. As such, training and support for teachers are important components of an e-learning education. This is in relation to the different roles that teachers would be playing in an e-learning environment. The transition from face-to-face to an online setting requires relevant and effectively planned professional development courses. Are teachers ready to meet the challenges brought by the increase in demand for e-learning? A study carried out by Kim and Bonk (2006) found that most of their respondents believed that monetary, pedagogical and technical competency are some of the more important factors that affect the success of any e-learning initiatives. Instructors' abilities, skills and commitment to teach online are critical to the success of any e-learning. Their willingness to adopt is also an important consideration. Instructors' pedagogical conceptions and values often do not include using ICT as part of their teaching and learning process. Continual management of the e-course also makes the instructors' work time-consuming. Teachers perceptions of extensive time required are the key obstacle to e-learning. More time is felt needed to plan, create and maintain a course and to motivate and spark interest among students to work online are just some of the many challenges to successful implementation. Their level of personal innovativeness also to a large extent will determine if they will take the extra steps to experiment and implement any new innovation.

In Malaysia, recent development has seen the launched of the Malaysian Education Blueprint which is a detailed plan of action that maps out the education landscape for the next 13 years (2013-2025). Realising the gap towards producing a more technologically literate workforce, one that is relevant to the 21st century knowledge and skills, it has identified 11 shifts that will need to occur to deliver the change in education outcomes envisioned by all Malaysians. The National Education Blueprint emphasizes effort to leverage ICT in order to improve the quality of learning across the country. Twenty five initiatives have been identified under the first wave of the Malaysian Education Blueprint (2013-2015). One of them includes providing 1BestariNet and software for schools. 1BestariNet is a project led by the Ministry of Education (MOE) to provide access to a cloud-based virtual learning platform known as the FROG VLE (adopted from United Kingdom) and high-speed connectivity by June 2014 to all the 10,000 fully-aided government schools.

1BestariNet is to replace Schoolnet which was launched in 2004. Schoolnet fell short of expectations, especially in terms of speed (only 1Mbps), capacity and lack of specifications and integration. This ambitious technology-in-education project will cost Malaysian taxpayers RM1.5 billion (nearly US\$500 million) and its implementation is expected to run over 13 years. 1BestariNet IDs has been made available to all students, parents and teachers in all the schools nationwide, where they now have single-sign-on access to the Frog Virtual Learning Environment (VLE), Google Apps for Education and the FrogStore. Through the Frog VLE, teachers are able to digitize their teaching content and explore new ways of bringing the best resources and teaching methods to be shared across

the 10,000 schools. Learning anytime, anywhere is now possible with free Internet access available to all 10 million teachers, students and parents in the schools in Malaysia.

2.2 New Pedagogy and Technology for E-Learning Educators

Stepping into any classrooms today is almost the same as stepping into any classrooms 20 years ago. Although technology is used in every aspect of our students' lives, the same does not happen in the classrooms. Instead, in schools computing is an organised event, scheduled according to the convenience of timetabling. The gap between what students can do with technology and allowed to do with it in school is expanding with each passing day. Teacher Professional Development Courses, trainings, workshops and in-house sharing have been less than successful in helping teachers to be motivated to integrate technology for teaching and learning. School leadership is often not able to provide strong leadership and strong support due to their own lack of technological knowledge and experience. Even new teachers, whom the school communities looked up for guidance on technology use, hardly infuse technology into their own classrooms. Current teacher preparatory programmes are not effective enough in equipping these new teachers with the much needed skills and knowledge that are required to transform today's classrooms. They are just not taught to handle effective infusion of technology in all subject areas. Lacking in widespread support and professional development, existing teachers are not able to make the necessary changes to their classroom practices. Even the enthusiastic ones with high level of expertise may give up due to the barriers they faced. However, the fact remains that learning to teach and learn in new ways with technology is no small task. Imagination, intellectual stamina, creativity and a huge courage is needed (Jacobsen, Clifford & Friesen, 2002).

According to Guskey (1986), many educational initiatives fail because of two factors; management fail to understand what motivates teachers to engage in professional development and the processes by which change in teachers typically occur. Trainings and professional development courses will only work if teachers can be shown evidence of improvement in their students' learning outcomes, even more so in our exam-oriented community. This is the prerequisite if we want to see significant changes in the attitudes and beliefs amongst our teachers. Experienced teachers are seldom committed to new instructional approaches until they have seen it worked in their classrooms with their students (Guskey, 2002). Training and implementation that are combined with improved students' learning will have more chances at incurring changes in attitudes and beliefs among teachers.

Change brings with it a certain amount of anxiety and threat. Why teachers are reluctant to change is because they are not sure if they can make the new practices work (Lortie, 1975). As change means risking failure, teachers do not easily alter or discard the practices that they have long developed and refined (Bolster, 1983). Technology intimidates even experienced teachers, as it makes them feel stupid, inept and at the mercy of situations where they do not understand and have no control. Change will not be implemented uniformly across schools as teaching and learning are influenced by a number of situational and contextual factors. Close collaboration between the system's developer, and management will be of tremendous help in facilitating change among the teachers. Regular feedbacks on what they are doing, can sustain any little change they are trying to make.

Sustaining change after the implementation period must be seen as a continuous and ongoing endeavour. Considering the importance of their role, teachers' perceptions of the newly implemented FROG VLE must be considered and taken into consideration for the betterment of the e-learning implementation in Malaysian schools. Though there are a number of studies carried out in other countries, effects of differences in context should not be discounted. Development of educational ICT path for every country is unique with its own educational, social, political and cultural contexts. These will differentiate factors that influence ICT usage among teachers according to the countries which they are from. So this study will be particularly useful in identifying factors that are affecting Malaysian teachers' use of the e-learning.

3. Method

3.1 Participants

Participants in this study were 60 teachers from three secondary schools from two states in Malaysia. 18.33% of them mentioned no training was received so far while 75% indicated that they have received training with 6.67% did not indicate. 70% of them have less than fifteen years of teaching experience while the rest has more. As for the age of the respondents, 40% are male, one did not indicate, while the other 58.33 % are female. As for their age mainly were in the 41 to 50 years old range (refer Table 1).

Table 1: Distribution of Participants' Age in the Survey

Age Range	Percentage
24-30	20%
31-40	23.34%
41-50	45%
51-60	11.66%

3.2 Procedures

Participants responded to an open-ended questionnaire administered to them in schools. An open-ended survey form with three questions that inquired about teachers' perceptions of the benefits, barriers and suggestion for improvement towards the FROG VLE were distributed. Data were collected about six months after the FROG VLE's was implemented across the nation.

3.3 Measures

Open-ended survey form was employed as the data collection method. Three questions posed were meant to provide a window on what was working or not working and what needed further refinement in the recent implementation of e-learning. The data collected were then analysed for key themes or patterns in teachers' perceptions of the e-learning in schools. The data were analysed and results of the analyses were reviewed to verify for accuracy and enhance reliability. In our analysis process, we are aware of Van Maanen's statement (1988), whereby, there can never be "immaculate perception", and no text or research may be closed to further interpretations (Van Maanen, 1988). The study would provide different interpretations had it involved different researchers and participants and was carried out in another place or at a different time. With this realisation, the researchers have approached this research with the belief that there will not be any single one truth; instead there will be many, with multiple realities and multiple interpretations of the same events (Cohen et al., 2000).

4. Results

Several themes emerged from our analyses of the open-ended questionnaire. The findings were summarised and organised by the aforementioned three research questions.

4.1 Benefits of Teaching Online

4.1.1 For the students

Most teachers recognised that the FROG VLE has created lots of interest among the students. Besides interest, easy access to a wealth of materials and resources were some of the main benefits identified. These teaching and learning resources can help to improve learning outcome and increase self-directed learners among the students. Flexibility in learning regardless of place and time, increases motivation among the students and in the process it also increases their ICT usage and awareness of ICT's potential as an alternative way to learning. This 'updated' approach of learning, in the long run provides greater opportunities when these students enter the job market. Respondents felt students will be more equipped with the much needed 21st century work skills. FROG VLE is more student-centered with its reduced need for teacher talk. However, despite the reduced in teacher talk, surprisingly a few teachers

felt that their interaction with their students can be increased through e-learning. Another important finding was when a number of teachers claimed that the system provides “hands-on” information for the students. These may be that with technology, students can view, listen, reflect and just do about anything in order to comprehend any new items that they wished to learn.

4.1.2 For the teachers

Many of the teachers appreciated FROG VLE in helping them make their teaching job easier than the traditional approach. Besides being easy to use, the system also helped them to organise their teaching and learning materials. This saves their time when updating or locating for specific materials. They are also pleased that with the system, they need not print or distribute handouts and this reduces cost substantially.

4.2 Barriers to Teaching Online

4.2.1 Within the School

Some teachers viewed lack of time as the key concern towards the e-learning implementation. They claimed the workload in school prevented them from exploring and mastering the system further. As such, many expressed critical need for more training and exposure of the system. Despite having trained, ICT skills remained an issue with the teachers. Not having technical support was also stressed as a main challenge in utilising the system, and teachers felt management should be working on this aspect to ease the innovation’s adoption process. Besides having limited ICT skills, lacking in English proficiency is also a barrier in understanding the FROG VLE. Some felt the language used was difficult for them to understand including the students. The inability to understand the language used by the system even caused confusion as claimed by some teachers. Validity of information over the internet was also questioned. Another identified barrier was having too many students in a class (30-40). This made it difficult for them to implement e-learning in the classroom. It is a challenge to let students take more responsibility for their own learning as they were not always on task. Whatever the technology being used, teachers with strong classroom management skills and ability to create a positive classroom culture are needed. Students tend to get distracted and visit other than the suggested websites, thus this lack of control was considered a struggle in running e-learning in the classrooms. One teacher also mentioned that she felt students were lazier when using the e-learning. Some felt teachers’ initial guidance is heavily needed by the students due to students lacking in skills and exposure in using the system. Nearly all teachers complained of poor internet connection and facilities as the greatest barrier towards e-learning implementation. Slow internet connection and that only certain areas in the school have access to the internet made it difficult for the teachers. They also claimed that they do not have enough working computers to make e-learning possible during their lessons. As such, due to the constraints expressed, plus high maintenance incurred by e-learning, some teachers insist preference over the traditional face-to-face approach.

4.2.2 Beyond the School

Teachers in their comments made it clear that not all students have access to internet and computers at home. These are the basic necessities that they felt the Malaysian government need to look into before exercising e-learning in our education system. To make matters worse, rural areas in Malaysia will need more time to make e-learning a reality. Students’ involvement beyond the classroom walls can only be turned into a reality when these barriers are removed.

4.3 Suggestions for Improvement

4.3.1 Training

Suggestions provided by most of the teachers reflected the urgent need for more training and assistance in delivering the e-learning. Technical support is necessary though very few teachers suggested this. Most of the teachers instead mentioned their lack of skills and confidence in utilising the FROG VLE.

They are of the opinion that with more skills and knowledge of the FROG VLE, they would be able to increase their usage. This should also be extended to trainee teachers at the Teacher Training Institute.

4.3.2 Facilities

A vast majority of teachers in the survey provided suggestions related to providing and upgrading the facilities in schools. Most teachers are crying out for better access to the internet, and ICT devices like laptop, both at school and at home. Internet access and computers for students at home must also be provided.

4.3.3 Awareness

Awareness programmes must be carried out to inform students, teachers and parents as to the e-learning initiatives. More enthusiastic involvement from students and soft pressure from the parents will hopefully create more urgency and motivate the teachers in sustaining the e-learning. Some respondents even suggested having a monthly e-learning programme, to make it more of a whole school initiative instead of individual teacher's effort in the confine of his or her classroom.

4.3.4 FROG VLE's Relevance

Subject like Mathematics was felt not compatible with the online system used. Innovative practices must be linked to school curriculum for sustainability. Teachers mentioned that they were not able to use certain symbols necessary in their teaching. A few teachers commented on the webpage design and content. The internet access to the e-learning is also restricting teachers' usage or visits to certain websites, the Youtube for example. There were mixed opinions regarding this restriction as some agree to this while others felt this restriction was not necessary.

5 Discussions and Implications

The research described above sought to investigate the use of e-learning in the classrooms, as perceived by teachers, its benefits and barriers. They were also asked to provide some suggestions on how e-learning implementation can be sustained and improved. An open-ended survey was created which included three questions pertaining to the focus of this study. These findings are significant as they come directly from those who have the greatest power to provide an impact towards the success of the e-learning initiative. Findings suggest that e-learning has created lots of interest among students and could improve students' learning outcomes as was also found in a number of previous studies (Vaughan, 2010; Callopy and Arnold, 2009). E-learning was also found to be helpful as it helped teachers in managing their materials and resources. Teachers also acknowledged that the use of e-learning provides opportunities for students beyond what they can offer in their traditional classrooms.

This study also provides important information as to the barriers in using e-learning. If e-learning is to be successful, teachers must have the appropriate technology, training and time to spend on the system. Trainings must not cease after the implementation, instead continued throughout the initial implementation when struggles are likely to be at their greatest. Moderate skill level and comfort in using the technology is a necessity. This is because their personal comfort and confidence will to a large extent depict how they approach the use of technology, design their lessons and approach the use of technology. Administrative support is also important especially by looking into facilities that are critically needed, like a reliable and fast internet connection plus to provide enough computers for all students. Administrators need to play a more active role in creating conditions in fostering the innovation. They must be the one who need to identify with the innovation, persuades and cajoles others into adopting the innovation. Their importance has many times been confirmed in many past empirical studies (Lafford, 2009; Young, 2008). Having access to internet at home is still not possible for many students. Involvement of parents was repeatedly stressed in order to overcome barriers. By educating parents as to the importance of e-learning, and if financial is not an issue, we would be able to see more students' houses equipped with computers and internet access.

Analysis of findings on suggestions also showed heavy focus on the need for training and facilities for better uptake of the e-learning. Teachers realised the need for them to learn many new skills and unlearn instructional pedagogical practices that have long dominated their professional lives. To do this, teachers must be given ample time and support to master the FROG VLE. Learning to teach an online course requires time, preparing for online teaching involves considerable time, effort and workload. Kaleta, Skibba and Joosten (2007) in their study even proposed that teachers were to be given the necessary training at least six months before implementation. Creating a community of practice among the teachers may be a good idea as then teachers will not feel alone in their struggle. They will then have each other to bounce off ideas and make planning and preparation easier.

Carrying out this study has shown us a number of pertinent aspects about the e-learning implementation in Malaysian schools nationwide. The first most obvious was that most schools are not well-equipped. Poor internet connection and insufficient computers to cater for big number of students in each classroom made it quite a challenge for teachers to carry out online learning. Our second finding points towards the critical lack of training and support for teachers. There was a unanimous plea to provide teachers with the necessary ICT qualifications as to enable them to effectively engage students in using ICT to enhance their learning. Technological infrastructure and technical training are important aspects if e-learning success is to be expected. Finally, we also realised the lackadaisical attitude among the teachers, administrators and the relevant government agencies in trying to make this innovation a success. However, all is not lost as we also found some schools which were not involved in this study, but who are doing extremely well in their e-learning initiatives. Though their numbers are small, future studies need to study these schools in order to understand how barriers were removed in their contexts. Hopefully, they can act as catalyst of change for other schools to follow suit.

6 Conclusion

As mentioned by Einstein, “The only source of knowledge is experience”, teachers must start experimenting and experiencing with e-learning or Malaysian education system will be left far behind. This modest study was an attempt to explore teachers’ perceptions of the newly implemented online learning across the schools in Malaysia, in order to accelerate the usage of e-learning across schools nationwide. Lacking in facilities and training were found to be the most common barrier among educators. As such, increasing the sense of urgency to use technology must be accompanied with reliable and effective on-going support by providing what teachers need. Knowing the benefits of e-learning alone will not help accelerate the adoption process if teachers do not have sufficient pedagogical and technological knowledge and skills. Room to experiment, to make mistakes, to try again and finally learn must be made part of the school culture if change is expected.

References

- Cohen, L., Manion, L., & Morrison, K. (2000). *Research Methods in Education*. Routledge Falmer: New York.
- Christensen, C. M., Horn, M. B., Caldera, L., & Soares, L. (2011). *Disrupting College: How Disruptive Innovation Can Deliver Quality and Affordability to Postsecondary Education*. Innosight Institute.
- Collopy, R. & Arnold, J. (2009). To blend or not to blend: Online and blended learning environments in undergraduate teacher education. *Issues in Teacher Education*, 18(2), 85-101.
- Guskey, T. R. (2002). Professional development and teacher change. *Teachers and Teaching: theory and practice*, 8(3), 381-391.
- Guskey, T. R. (1986). Staff development and the process of teacher change. *Educational researcher*, 15(5), 5-12.
- Horn, M. B., & Staker, H. (2011). *The rise of K-12 blended learning*. Innosight Institute.
- Jacobsen, M., Clifford, P., & Friesen, S. (2002). Preparing teachers for technology integration: Creating a culture of inquiry in the context of use. *Contemporary issues in technology and teacher education*, 2(3), 363-388.
- Kaleta, R. Skibba, K. & Joosten, T. (2007). Discovering, designing and delivering hybrid courses. In A.G. Picciano & C. Dziuban (Eds.), *Blended learning: Research perspectives* (pp111-144): The Sloan Consortium.
- Kim, K., & Bonk, C. J. (2006). The future of online teaching and learning in higher education: The survey says. *Educause quarterly*, 29(4), 22.
- Lafford, B.A. (2009). Toward an ecological CALL: Update to Garrett (1991). *The Modern Language Journal*, 93(s1), 673-696.

- Lortie, D. C., & Clement, D. (1975). *Schoolteacher: A sociological study* (pp. 1-54). Chicago: University of Chicago Press.
- MOE Malaysia, 2012. *Education Blueprint 2013-2025*.
- S. Bolster, Jr, A. (1983). Toward a more effective model of research on teaching. *Harvard Educational Review*, 53(3), 294-308.
- UNESCO Asia Pacific Regional Bureau for Education APEID/ICT in Education. (2013). *ICT in Education Policy, Infrastructure and ODA Status in Selected ASEAN Countries*. Bangkok: UNESCO Bangkok.
<http://www.moe.gov.my/userfiles/file/PPP/Preliminary-Blueprint-ExecSummary-Eng.pdf>
- Vaughan, N.D. (2010). A blended community of inquiry approach: Linking student engagement and course redesign. *Internet and Higher Education*, 13, 60-65.
- Young, D.J. (2008). An empirical investigation of the effects of blended learning on student outcomes in a redesigned intensive Spanish course. *CALICO Journal*, 26(1), 160-181.
- Yueh, H. P., & Hsu, S. (2008). Designing a learning management system to support instruction. *Communications of the ACM*, 51(4), 59-63.

Unpacking the Researcher-Teacher Co-Design Process of a Seamless Language Learning Environment with the TPACK Framework

Lung-Hsiang WONG*, Ching Sing CHAI, Ronnel KING, Xujuan ZHANG, Guat Poh AW
National Institute of Education, Nanyang Technological University, Singapore
*lunghsiang.wong@nie.edu.sg

Abstract: Integrating InfoComm Technology (ICT) into teaching and learning poses challenges for teachers, such as the lack of know-how, self-efficacy and time to design interventions. A possible solution is the design of sound Technology-Enhanced Learning (TEL) environments with relevant content and pedagogical tools to reduce teachers' design efforts. Technological pedagogical content knowledge (TPACK) could be used as a framework for understanding how teachers could integrate ICT into classrooms. Originally developed for informing teacher development, recent scholars called for 'repurposing' the framework to guide the design of TEL that encapsulate holistic TPACK knowledge. We therefore employed TPACK to design the TEL environment of 'MyCLOUD' to advance the use of mobile and cloud technologies for seamless Chinese Language learning. In this paper, we unpack how the distributed TPACK resources has contributed to the design of MyCLOUD. The analysis is accomplished through our coding and consolidation of 42 researcher-teacher meeting minutes throughout the developmental period where rounds of design-implementation-reflection- redesign process were jointly carried out by the participants. This is followed by a study of students' perceived usability of the platform. This study therefore demonstrates how the development of TEL can be attained by leveraging TPACK as a basis of technical design.

Keywords: Seamless Language Learning; Technological Pedagogical Content Knowledge (TPACK); Design analysis; Design-based Research; User Acceptance Test

1. Introduction

Integrating InfoComm Technology (ICT) into teaching and learning poses huge challenges for teachers, such as the lack of know-how, self-efficacy and time to design useful interventions (e.g., Laferrière, Hamel, & Searson, 2013). A possible solution is the design of sound Technology-Enhanced Learning (TEL) environments to reduce their design efforts. Well-designed TEL environments with relevant content and pedagogical tools in place would reduce the cognitive load and help shape and elevate their competencies in enacting ICT-mediated pedagogies.

Technological pedagogical content knowledge (TPACK) could be used as a guiding framework for understanding how teachers could integrate ICT into actual classrooms (Mishra & Koehler, 2006). The TPACK framework argues that effective technology integration for teaching specific content or subject matter requires understanding and negotiating the relationships between these three components: Technology, Pedagogy and Content. Many studies have adopted this framework to design teachers' professional development (TPD) activities, which have supported its efficacy for enhancing teacher competencies. Recent scholars (Chai, Koh, & Tsai, 2013) called for 'repurposing' the framework for informing the design of TEL environments that encapsulate holistic TPACK knowledge. To date, however, there has been only one such environment designed for the learning of software development by computer engineering undergraduates (Wu, Chen, Wang, & Su, 2008).

We therefore employed the TPACK framework to design a TEL environment to advance ICT integration for self-directed, collaborative and seamless Chinese learning. Code-named MyCLOUD (My Chinese Language ubiquitous learning Days), the design-based research (DBR) project is intended to develop a new mobile- and cloud computing-assisted language learning practice that encompasses multiple learning spaces. The iterative development of the MyCLOUD 1.0 learning environment, which

is comprised of a technological platform, classroom pedagogy and learning materials, took place from September 2010 to November 2012. It involved the participation of university researchers and primary school Chinese teachers in Singapore.

In this paper, we unpack how the various knowledge resources had contributed to the design of the TEL environment. The retrospective analysis is accomplished through our coding and consolidation of meeting minutes throughout the developmental period where rounds of design-enactment-reflection-redesign process were jointly carried out by the researchers and the teachers. This is followed by a study of students' perceived usability of the platform. This research therefore contributes to current development of TEL, which may be overly technology-centric, by using TPACK as a basis of system design. We argue that TPACK is essential in enhancing the ecological validity of the TEL environments.

2. Literature Review

2.1 TPACK

The TPACK framework specifies three forms of knowledge: technological knowledge (TK), pedagogical knowledge (PK) and content knowledge (CK), which are all needed in order to integrate ICT into classrooms. When these three forms of knowledge interact, technological pedagogical knowledge (TPK), technological content knowledge (TCK), pedagogical content knowledge (PCK) and technological pedagogical content knowledge (TPACK) are formed. TPK are knowledge about how to use different technologies in a pedagogically sound manner; TCK are forms of content representations that ICT can provide for specific form of CK, and PCK are the knowledge teachers possess to help bridge students' understanding of CK. TPACK are the syntheses of all aforementioned forms of knowledge for ICT integrated lessons (Cox & Graham, 2009). Teachers need to acquire or create such knowledge for sound integration to happen. Learning technologists can also draw from the research in TPACK when they develop technology to enhance learning. We therefore review relevant aspects of knowledge, including language learning (CK/PCK-related), seamless learning (PK/TPK-related), and the notion of 'learning hub' (TK/TCK-related). This is to path the way for the creation of the MyCLOUD environment.

2.2 The CK/PCK related consideration: Chinese language learning

Classroom practice inevitably shapes learners' language learning practice and impact upon their language competencies. Contemporary language learning researchers (e.g., Liu, Goh, & Zhang, 2006; Tedick & Walker, 2009) have argued that that conventional language classrooms typically fall short in the following aspects: (1) They are overly teacher and knowledge centric (2) De-contextualized; (3) Predominantly "presentation-practice-production" (PPP model); and (4) Disconnections between skills and knowledge. Traditional language classrooms fail to practice autonomous learning by the learners and authentic social interactions beyond the classroom. Such practices are not conducive in developing learners' communicative skills and elevating/sustaining their learning motivation (Liu et al., 2006; Wong, Chai, & Aw, in-press).

The above shortfalls prompted the emergence of sociocultural and communicative approaches towards language learning (Lightbown & Spada, 2013), which view language learning as an active process where learners make meaning through activities that reflect real-world contexts (Widdowson, 2003). Social interaction is the context where language use and language learning co-occur (Min, 2006). Participation in social interactions is the goal and the means for language learning. These imply that language learning needs to depart from transmissionism and promote authentic and social learning.

2.3 The PK/TPK related demands of 21st century— seamless learning

Seamless learning is one of the advanced learning approaches that can potentially address the needs of 21st century learners in dealing with the challenges posed by the era of exponential changes. Chan et al. (2006) advocate that the key of seamless learning is in leveraging 1:1 (one-or-more-device-per-student) setting to facilitate anytime anywhere learning. This fosters among learners the bridging of learning efforts across a variety of settings (e.g. formal/ informal learning, individual/social learning, and learning in physical/digital realms). Seamless learning has evolved from a technology- enabled mobile and

ubiquitous learning approach (e.g., Hwang, Tsai, & Yang, 2008) to a constructivist curriculum design or knowledge creation approach (Looi & Wong, 2013); and moved beyond situated learning where learning is no longer confined within a single ‘situation’ but reference to a learning culture (Milrad et al., 2013). Seamless learning pedagogy should therefore focus on long-term fostering of learners’ disposition and skills in carrying out seamless learning, thus resulting in the emergence of a new learning community.

2.4 The TK/TCK related consideration: ‘Learning Hub’ with tools

‘Learning Hub’ is a notion arisen from earlier research in seamless learning (Zhang et al., 2010). The mobile device carried by a learner on a 24x7 basis could integrate all the personal learning tools, resources and self-created artifacts at one place, thus serving as a learning hub. The learning hub can facilitate a learner in managing her/his own seamless learning journey. Suitable learning resources that the learner acquires along her/his ongoing learning journey to mediate the latest learning task could be stored, used and modified conveniently (Wong & Looi, 2011). Simply put, a ‘learning hub’ should be the nucleus of: (1) a suite of tools to support learning activities, and (2) the medium to document the learner artifacts. In addition, Wong (2012) argued that the fast-rising cloud computing technology offers personal ‘learning hub’ that need not be associated with any device. Instead, it may exist as a learner account that stores the learner’s history on a cloud-based platform with a suite of learning tools.

The above review sums up current issues of language learning (CK/PCK) which mobile-related technologies complemented by cloud computing (TK/TCK) could be designed to support socio-centric constructivist pedagogy (PK/TPK). These considerations formed the grounds for MyCLOUD.

3. Research Context

MyCLOUD is a DBR study with the aim of developing a seamless Chinese Language learning environment for Singapore primary school students with Chinese as second language standard. The key idea is to facilitate a long-term seamless language learning practice that is blended into the formal curriculum to foster a cross-space ongoing learning process among the learners. The conceptualization and development of the MyCLOUD environment began in September 2010, which was subsequently piloted in three Primary 3 classes in the experimental school between August 2011 and November 2012.

We adopted DBR as the methodology, which considers the subject of study to be a complex system involving emergent properties that arise from the interaction of more variables than are initially known to researchers (Brown, 1992). Therefore, design-based researchers attempt to optimize the design in real-life settings and to observe how different variables and design elements interact (Barab & Squire, 2004). Hence, the design-enactment-reflection-refinement cycles are iteratively conducted with conjectures created and perhaps refuted, and new conjectures are developed in the next cycle and tested.

This paper reports the first DBR cycle of the MyCLOUD project from September 2010 to November 2012. During the cycle, the university researchers and 4 Chinese teachers formed a taskforce to progressively co-design, enact and refine the learning environment. The platform development was outsourced to a commercial software developer. The DBR cycle consisted of 2 phases:

Phase 1: Learning environment conceptualization and design (Sep 2010–Jun 2011). The taskforce met fortnightly to co-design the learning environment, with frequent participation from the software developer. Phase 1 ended with the launch of MyCLOUD 1.0 in July 2011.

Phase 2: Curriculum piloting and pedagogy refinement (Jul 2011–Nov 2012). The 16-month pilot study in three Primary 3 classes commenced and the fortnightly taskforce meetings continued. The researchers observed and analyzed the curriculum enactment and the students’ learning progress for reflection and tweaking of the learning environment design.

In this paper, we unpack our reasoning and articulate the knowledge resources we work on to holistically design the MyCLOUD 1.0 learning environment as guided by the TPACK framework. This is followed by a study of students’ perceived usability of the platform. This paper is therefore positioned as a design synthesis paper or design analysis paper on the learning environment; while the detailed analysis of student learning processes and outcomes are reported elsewhere (Aw, Quek, Wong, Zhang, & Li, in-press). The research questions that guide the writing of this paper are,

RQ1. How did the taskforce collectively create and improve MyCLOUD 1.0?

RQ2. What were the students’ perceptions of usability, ease-of-use and acceptance of MyCLOUD 1.0?

To address RQ1, we qualitatively analyzed 42 written minutes of taskforce meetings to distil the important design decisions that led to the creation of MyCLOUD 1.0. Two researchers coded the documents independently in terms of TPACK-related decisions made (with Table 1 as the coding scheme). The coding traced the 7 categories of TPACK that were discussed during the meetings and the new forms of TPACK co-created by classifying them according to the categories. The two coders then compared the coded documents and discussed discrepancies (about 15% of the codes) until consensus was reached. Adapted from the analytical scheme presented in Wu et al. (2008), the qualitative outcomes of the analysis is then consolidated in a two-dimensional matrix for each phase: 7 categories from TPACK versus 3 categories (new design ideas, emergent challenges and solutions).

Table 1: Coding Scheme of TPACK decisions.

Construct	Example
Technological Knowledge (TK)	How to use the functions of mobile devices and MyCLOUD platform.
Pedagogical Knowledge (PK)	How to facilitate language learning through pedagogical strategies such as seamless learning.
Content Knowledge (CK)	How to use domain-specific content knowledge such as orthographic (word structure), phonic (pronunciation) and functional knowledge of Chinese language.
Pedagogical Content Knowledge (PCK)	How to enhance students' vocabulary knowledge through contextualized writing activities.
Technological Pedagogical Knowledge (TPK)	How to facilitate socio-constructivist learning through the social networking feature in the MyCLOUD platform.
Technological Content Knowledge (TCK)	How to construct linguistic knowledge through the use of Mictionary and other online dictionaries.
Technological Pedagogical Content Knowledge (TPACK)	How to carry out an ongoing, contextualized and collaborative language learning process by applying the MyCLOUD learning model.

To answer RQ2, we administered a questionnaire to 259 students from the entire Primary 3 level in the experimental school who were enrolled in the scaled-up MyCLOUD curriculum in 2013. We adapted the survey instrument developed by Chen and Huang (2010), which is comprised of three factors: perceived usefulness, perceived easy to use, and system acceptance. The items were reviewed by the teachers before administering to ensure language suitability.

4. Design Synthesis

4.1 Phase 1 (learning environment conceptualization and design) (Sep 2010 – Jun 2011)

The phase began in September 2010 with the teachers informing the researchers on existing Primary 3-4 curriculum, their classroom practices, and students' learning difficulties, i.e., the design considered teachers' CK, PK and PCK as essential inputs. The teachers acknowledged that they were practicing the PPP model; while the students' common learning difficulties include the lack of self-efficacy in learning the language and applying it in daily life due to limited vocabularies, English-style grammar, etc. An agreement was reached that MyCLOUD is not (merely) meant for enhancing the existing pedagogy. The intention was to foster a new language learning practice informed by the sociocultural perspective of SLA by leveraging all opportunities of language learning, applications and reflections within and beyond the class hours. The taskforce then spent 10 months to co-design and prototype the TEL environment, with the involvement of a software vendor in the aspect of ICT development. As the university could not support the development, the taskforce outsourced the technological development work. The limitation of such an approach was revealed in Phase 2 (see later). Tables 2 summarizes our qualitative analysis on the most important decisions made during the meetings held within Phase 1.

Informed by the notion of seamless learning, the SLA theories and the research team's previous study (Wong, Chin, Tan, & Liu, 2010), the researchers sketched a design framework which were then discussed within the taskforce. Teachers' comments were received and the framework was adapted (Figure 1). The framework can be seen as the initial TPACK designed by the taskforce, comprising of the intertwining dimensions of seamless and language learning. Within the seamless learning dimension, the Facilitated Seamless Learning (FSL) framework (Wong, 2013) is adopted as the basic learning process to guide the actual learning activities. FSL is represented as a cyclic, non-linear process that consists of the following four activity types (*CK1-1*, *PK1-1*, *PCK1-1* in Table 2):

- (1) *In-class learning engagement*: These are teacher-facilitated activities in formal settings, to get students to begin the learning of new vocabularies and prepare them for activities (2) and (3).

Table 2: TPACK-informed analysis on the major decisions made in Phase 1

ID	New design concept	Challenge	Solution
CK1-1	Deep learning of Chinese vocabularies not only in their meanings and pronunciations but also the ability of applying them in appropriate contexts.		
PK1-1	Learning Chinese through self-directed, contextualized language applications and social interactions. The learning design is student-centric and the pedagogy is meant for nurturing such a habit-of-mind among the students.		
TK1-1	Employ mobile & cloud technologies to develop MyCLOUD.		
PCK1-1	Tap on student artifacts in in-class consolidation activities for students to carry out peer reviews.		
TCK1-1	Tap on online resources, e.g., e-dictionary & voice synthesis, to support content learning.		
TCK1-2	Develop Mictionary functions that afford students to self-manage vocabulary learning.		
TPK1-1	Build personalized space (Mictionary) and social space (MyCLOUDNet) to reduce student perception on MyCLOUD as a formal learning environment.		
TPK1-2	Adopt duo-platform model: MyCLOUD app for just-in-time learning tasks (e.g., artifact creation and social interactions) that is blended into daily life; and web version accessible from home computer for more complex tasks.		
TPK1-3	Build simple learning analytics on students' activeness, e.g., to display number of new vocabularies added to Mictionary, number of artifacts created, etc., over a period of time.		
TPK1-4	Implement classroom management module where teachers may enable or disable certain sets of tools on student devices at different time. This is to prevent or reduce the 1:1 classroom management issue where students might misuse the devices during lessons.		
TPACK1-1	The platform should facilitate easy, semi-automated bridging of multiple learning spaces: formal (My Textbook) and informal (Mictionary) spaces, individual (Mictionary) and social (MyCLOUDNet) spaces, etc.		
TPACK1-2	An existing classroom practice is that the teachers instruct the students to highlight unfamiliar words on the textbook. The "My Textbook" component of MyCLOUD should provide a similar affordance – students use the mouse to highlight salient vocabularies, right click to add them to Mictionary.		

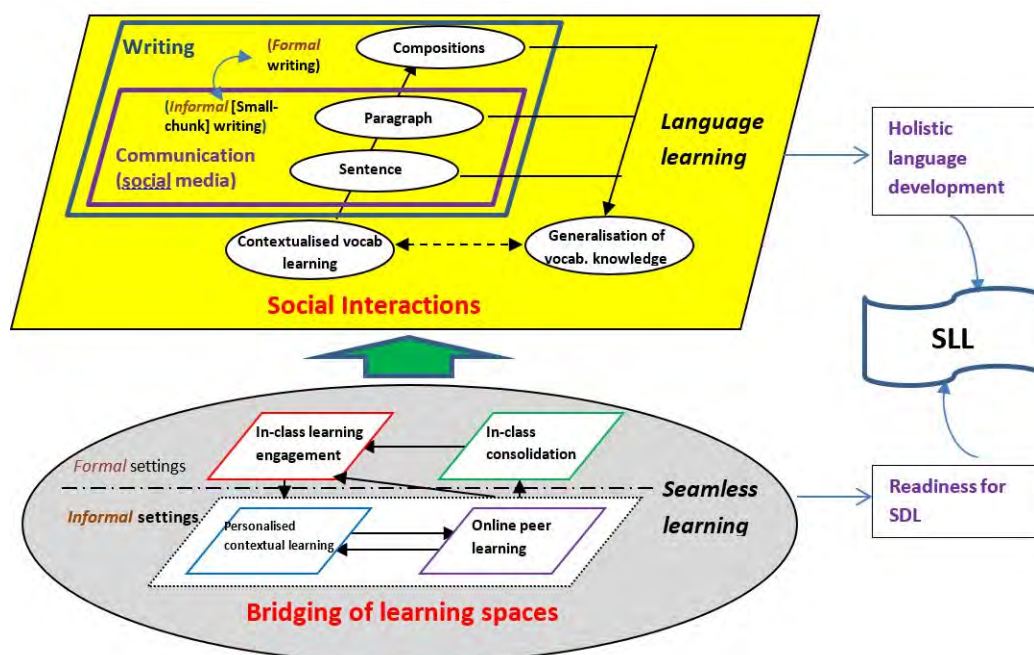

Figure 1. The learning design framework of MyCLOUD.

- (2) *Personalized contextual learning*: Individual learners proactively observe, record, and reflect upon their daily encounters and apply their knowledge in their daily life. In MyCLOUD, the activities constitute of taking photos and making sentences pertaining to their daily encounters and posting such student artifacts onto MyCLOUD as social media.
- (3) *Online peer learning*: In the online social space, learners carry out peer discussions mediated by their prior knowledge, resources, reflections and learner artifacts created during (1) and (2).
- (4) *In-class consolidation*: Teachers facilitate and scaffold learners in in-class discussion and consolidation on teacher-supplied or learner-created artifacts during the entire FSL cycle.

Meanwhile, as depicted in the upper layer of language learning dimension, students individually create the digital language artifacts in the forms of sentences or paragraphs with or without photos to be uploaded. In the community, these artifacts are shared, reviewed and revised for deeper learning.

Informed by the framework, the taskforce and the software vendor proceeded to co-design MyCLOUD with the following main modules,

- **Mictionary:** Mictionary refers to ‘Mobile dictionary’. In Mictionary, students record the vocabularies that they encounter in and out of class, and perform searches for meanings and exemplary uses. It serves as their personalized vocabulary learning e-portfolio where they are required to build most of the content on their own, such as adding the photo-sentence artifacts that utilize the vocabulary on the ‘vocabulary page’ or pooling relevant online resources (*TCK1-2*).
- **My e-Textbook:** The digitized textbook passages are linked to a web-based text-to-speech service powered by Microsoft Bing for the platform to read them aloud. Students can highlight unfamiliar vocabularies and this will add the vocabularies to Mictionary (*TCK1-1, TPACK1-2*).
- **MyCLOUDNet:** This is a social networking space for students to tweet or carry out photo-blogging (photo(s) + sentence(s), i.e., ‘student artifacts’), and respond to others’ artifacts. Students may (1) perform peer reviews to improve the accuracy and complexity (linguistically or contextually) of individual artifacts; or (2) be engaged in social interactions. Both types of responses are collectively known as ‘replies’ hereafter (*TPK1-1*).
- **My Teaching Pal:** This is the classroom management module for the teachers to create lesson packages prior to the class, and manage the learning flow and enable all or selectively limit students’ accesses to the features on MyCLOUD platform during the class. (*TPK1-4*)

In essence, My e-Textbook belongs to the formal learning space while MyCLOUDNet is an informal space. Mictionary bridges the two spaces by linking to My e-Textbook and MyCLOUDNet. If a student creates an artifact and add it to a vocabulary page in Mictionary (individual, formal-informal bridging space), the artifact will also be automatically duplicated to MyCLOUDNet (social, informal space). Two types of peer discussions could emerge – corrective/enriching feedback or social interactions on individual artifacts in MyCLOUDNet. Such discussions can be characterized as social meaning making which may trigger individual learners’ reflections (*TPK1-1, TPACK1-1*).

The ICT architecture that we adopted to implement the MyCLOUD platform is the cloud-mobile model according to the revised ‘learning hub’ notion according to Wong (2012) (*TK1-1*). The platform is accessible by both a web-based interface and a mobile app. The former offers the full set of features while the latter provides a sub-set of functions for students to carry out quick learning tasks, such as creating student artifacts, online interactions and referencing to Mictionary, in their daily life.

In addition, we incorporated simple learning analytics features into the system, accessible by both the teachers and the students, such as reporting the frequencies of online activities of individual students and the whole class (e.g., new vocabularies added to Mictionary, artifact creations, online interactions, number of times each vocabulary is utilized by a student, etc.). This helped teachers to monitor student participation and adapt their interventions where necessary (*TPK1-3*).

The first working prototype of the MyCLOUD platform was implemented by the software vendor (see Figure 2 for the screen captures in the web version). Subsequently, a usability test was conducted by involving a group of Primary 3 students to use the tools and offer comments. The platform was then refined accordingly. The system was ready for deployment by July 2013.



Figure 2: Screen captures of the main components on the MyCLOUD platform (web version)

4.2 Phase 2 (curriculum piloting and pedagogy refinement) (Aug 2011 – Nov 2012)

MyCLOUD 1.0 was launched in July 2011. 84 students in three Primary 3 classes were then involved in a 16-month school-based pilot study. Each of the students was assigned an Acer Iconia Tab W501 tablet for 24x7 access. Similar to Table 2, the major decisions made during Phase 2 is summarized in Table 3. There was a major shift of focus in the taskforce’s design efforts – from conceptualizing a new intervention and transforming it to a learning environment in Phase 1 (i.e., more “Major design concepts” in Table 2), to developing concrete lesson plans and tackling the challenges emerged during the pilot study in Phase 2 (i.e., more “Emergent challenges” raised and addressed in Table 3).

Phase 2 was focused on the co-design of a basic lesson structure to guide future lesson designs (see *TPACK2-1* in Table 3). Nevertheless, the taskforce agreed that highly structured lesson plans may not be aligned with the spirit of constructivism and seamless learning. Instead, teachers and students should be encouraged to exercise flexibility. Consequently, the three teachers in the pilot study referenced the basic lesson plan structure, co-designed overarching learning activities for the chosen lesson units to be taught through MyCLOUD, and then individually adapted them to suit the profile and the progress of the students in their respective classes (i.e., ‘differentiated learning’).

Table 3: TPACK-informed analysis on the major decisions made in Phase 2

ID	New design concept	Emergent challenge	Solution
PK2-1		How could we assess students’ performance as they may not complete their assigned work?	Teachers strike a balance between student autonomy and teacher-directed activities. Moderately instill discipline as the students are very young. Enact formative assessment.
PK2-2		Students had been making superficial comments and corrections on peer artifacts on MyCLOUDNet.	Design scaffolds to nurture their peer critique and artifact re-writing skills, which should be enacted at the in-class consolidation sessions.
PCK2-1		Teachers’ early emphasis on teaching new nouns that relatively lack contextual diversity in their usage were one of the reasons for students’ creation of ‘dull’ artifacts.	Ensure greater form diversity in the choice of vocabularies to learn, i.e., nouns, verbs, adjectives, adverbs, conjunctions and idioms, etc. This may trigger students’ creation of more contextually rich artifacts.
TPK2-1		Students should be able to revise their artifacts posted on MyCLOUDNet after peer feedback. The edit function was not available on MyCLOUD 1.0.	Encourage students to post their revised texts as new replies to the original artifacts.
TPK2-2		Many students find difficulties in expressing in Chinese or inputting Chinese text in the beginning, thus unmotivated to participate in the online activities.	Allow students to use English sparingly for replies in the first 1-2 months but artifact creation must be in Chinese. Inform them upfront that after the grace period, they should use pure Chinese for online activities.
TPAC K2-1	Develop a basic structure to guide the design of individual lesson plans: (1) Read textbook passage; (2) Add vocabularies from My e-Textbook to Mictionary; (3) Small-group artifact creation, and posting on MyCLOUDNet; (4) Reply to artifacts created by other groups on MyCLOUDNet; (5) Class-wide sharing of artifacts and discussion.	On Step (2), though teachers would pre-select vocabularies from the textbook passage for students to focus on and add to Mictionary, weaker students might find other vocabularies unfamiliar to them.	Encourage students to identify unfamiliar vocabularies beyond what the teachers have specified, and add them to Mictionary.
TPAC K2-2	Students may add vocabularies incidentally used in their artifacts posted on MyCLOUDNet to Mictionary.		
TPAC K2-3	Design & enact learning processes that encompass the full FSL cycle and tap on specific events such as Chinese New Year in and mid-year school vacation.		
TPAC K2-4	Design & enact mobile learning trails at Haw Par Villa and Asian Civilisations Museum to facilitate collaborative and authentic language learning.		
TPAC K2-5		Some students face difficulties in making sentences with newly-learned vocabularies at classroom lessons.	Teachers co-design the following learning process where students work in groups to (1) search online dictionary for the vocabulary; (2) pick a sample sentence using the vocabulary; (3) search for a photo depicting the sentence; (4) modify the sentence by referencing to other elements in the photo.

Apart from classroom lessons, the taskforce also co-designed and integrated activities to reinforce students' authentic learning in daily life, i.e., to nurture their habit-of-mind in seamless learning. Two designs for these purposes are (1) Learning processes that encompass the full FSL cycle and tap on Chinese New Year and school vacation (TPACK2-3); (2) Out-of-school mobile learning trails to facilitate collaborative and contextualized language learning and applications (TPACK2-4).

Given the nature of DBR, ongoing refinements of the learning environment as triggered by emergent implementation challenges are inevitable. Thus, rapid (re-)prototyping of the platform was desired. However, the funding cycle prevented ongoing fine-tuning of MyCLOUD. This gave rise to the strategy as stated by a researcher, "(In seeking for solutions to the emergent challenges,) we can hold TK as a constant for the time being, and seek for tweaking PK and CK variables." Table 4 consolidates the proposed important enhancements on the forthcoming MyCLOUD 2.0 learning environment (in the 2nd DBR cycle) which emerged from the taskforce's tackling of challenges in Phase 2. The reporting of the 2nd DBR cycle is out of the scope of this paper as it has only started a few months before this paper is finalized (after we secured new development funding), with the MyCLOUD 2.0 platform still at its preliminary system design stage. We will report the implementation of and evaluation of the proposed enhancements in a future publication.

Table 4: Proposed enhancements in 2nd DBR cycle and MyCLOUD 2.0 platform

Pedagogical/Learning Design	
PCK3-1	Develop systematic strategies to nurture students' habit-of-mind and skills in creating quality artifacts and being engaged in meaningful social interactions and peer reviews.
TPK3-1	Derive effective principles or guidelines for teachers' presence in MyCLOUDNet communities, without overloading teachers. During the pilot study, teachers' involvement in student discussions were relatively ad-hoc.
TPACK3-1	Employ flipped classroom-like strategy by asking students to learn and even apply certain vocabularies (e.g., to create artifacts) before the lesson. The artifacts could then be discussed in the classroom.
Technological Upgrades	
TCK3-1	Advanced learning analytics to perform corpus analysis, social network analysis, etc. (To pick up what was left out in TPK1-3)
TPK3-2	Insert a field under each student artifact on MyCLOUDNet to encourage the author to improve the text after peer discussion (not directly edit the original text) so that both versions of text are displayed to make the improvements explicit to all students. This is for facilitation of process-oriented writing (a TPK solution to TPK2-1)
TPK3-3	Implement 'like' and 'badge' functions on the platform to boost student participation. (a TPK solution to PK2-1)

5. User Evaluation

Throughout the study, the university researchers had been collecting various forms of data to continually evaluate the designed learning platform. The findings in students' learning processes and outcomes, and the participating teachers' development and perceptions on the learning environment are reported elsewhere (Aw et al., in-press; Wong, Chai, Aw, & King, in-press). In line with the aims of this paper, the results of the user acceptance survey are reported. As stated before, the 20-item, 5-point Likert-scale survey instrument developed by (Chen & Huang, 2010) was adopted and customized to the context of the MyCLOUD environment. The survey examines students' perception of usefulness (PU), perceived ease-of-use (PEU) and user acceptance (UA). The survey was administered to 259 students in the beginning of the 2nd DBR cycle. To test the construct validity of the survey, confirmatory factor analysis (CFA) was conducted. After removing 3 items with low factor loadings, CFA yielded satisfactory model fit indices ($\chi^2 = 250.57$, $\chi^2/df = 2.16$, $p < 0.001$, RMSEA = 0.067, CFI = 0.95, GFI=0.90) (Hair, Black, Babin, Anderson, & Tatham, 2010). Average variance extracted (AVE) and the composite reliability (CR) were computed to further examine the instrument and the results indicate that the instrument is valid and reliable. Table 5 below provides the means, standard deviation and factor loading, AVE and CR. The findings from the usability tests indicates that the primary 3 students perceive the MyCLOUD 1.0 environment as acceptable (UA=3.82), easy to use (PEU=3.92) and useful (PU=3.74), since all ratings are above the mid-point of 3. The general efficacy of the platform is thus supported.

6. Discussion and Conclusion

In this study, we developed and evaluated MyCLOUD, a learning environment for Primary school students' seamless Chinese Language learning. The researcher-teacher taskforce designed specific modules of applications that utilize technological affordances to support pedagogical strategies for seamless Chinese Language learning, based on their understanding of the students' current learning practices and shortcomings. Specifically, the taskforce drew upon their collective TPACK knowledge to

build the learning environment. Such a holistic consideration of learning environment design was well-manifested in a comment made by a researcher during a meeting (24 December 2010), “*We need to be wary whether this suite of applications will actually complement or distract students’ learning. Although it may appear to be useful to have multiple tools on an integrated platform, the crux is what should be put inside. What we should introduce is a platform, not just a string of tools.*”

Table 5: Mean, SD, Factor loadings, AVE and CR of the user acceptance test (n=259)

Items	Mean	SD	Factor loading	
Factor 1: Perceived Usefulness (PU), AVE =0.59, CR =0.91				
PU1	MyCLOUD is helpful to my learning.	3.74	0.99	0.84
PU2	It’s more efficient for me to learn Chinese in MyCLOUD.			0.77
PU3	MyCLOUD can help me better understand Chinese vocabulary.			0.81
PU4	The smartphone with MyCLOUD is good for learning.			0.80
PU5	With MyCLOUD, I use Chinese more often than before.			0.75
PU6	I learn good Chinese sentences and compositions from my classmates on MyCLOUD.			0.60
PU8	I will continue to use MyCLOUD in Chinese learning in the future.			0.80
Factor 2: Perceived Ease of Use (PEU), AVE =0.52, CR=0.84				
PEU1	MyCLOUD platform is easy to use.	3.92	0.95	0.77
PEU2	MyCLOUD is a convenient platform for me to interact with my classmates.			0.72
PEU3	It is easy to upload pictures to MyCLOUD platform.			0.60
PEU4	It is easy to type in Chinese in MyCLOUD using smartphone.			0.71
PEU5	I find it easy to do what I want to do in MyCLOUD, such as commenting on others’ sentences.			0.77
Factor 3: User Acceptance (UA), AVE =0.52, CR =0.84				
UA1	Learning Chinese using MyCLOUD is enjoyable.	3.82	0.94	0.63
UA2	I like to make sentences in MyCLOUD.			0.63
UA3	I like to interact with classmates in MyCLOUD.			0.72
UA4	I like to post and share my interesting things in daily life in MyCLOUD.			0.76
UA5	I enjoy reading the teachers’ and peers’ online comments for my work.			0.83

Indeed, in the TEL field, many existing learning platforms were developed by pooling a variety of features without clear pedagogical considerations or design of learning flow to optimize the use of these functionalities. In designing MyCLOUD, we instead derived and mapped a variety of seamless language learning activities into the FSL framework to assist the students in establishing a coherent cross-space learning flow and experience. The three student-accessible modules of the platform were then designed to support the learning flow, particularly the bridging of formal (My e-Textbook) and informal (MyCLOUDNet) learning spaces (through Mictionary as the bridging module), individual (Mictionary) and social (MyCLOUDNet) learning spaces, and, learning amidst the interplay of physical and digital spaces during classroom lessons (using all three modules) and artifact creation tasks in authentic real-life settings (and subsequently posting on MyCLOUDNet and Mictionary).

Based on our qualitative analysis on the two-phased design process, whereas the entire design process was essentially underpinned by the researchers’ TPK (by proposing the notion of mobile- and cloud-mediated seamless learning and sociocultural perspective of language learning to frame the design), the teachers’ PCK that they established over the years of practice (students’ learning preferences and difficulties, classroom dynamics and resource limitations, etc.) had been playing a crucial role in creating conducive conditions for a scalable and sustainable practice. Therefore, the eventual learning environment by the end of Phase 2 is a manifestation of newly created TPACK.

Thus, this paper contributes to the TEL literature not only in term of explicating the development of an innovative seamless language learning environment. It has demonstrated how the TPACK framework can be employed to guide the design of a holistic TEL environment that leverage distributed TPACK knowledge of researchers, practitioners and software developers. Through the collective design effort of the taskforce, an easy-to-use and useful platform that is well accepted by the 3rd graders was created. In terms of learning outcomes, we have also obtained some positive findings (Aw et al., in-press). Given these results, we would recommend TPACK as a common framework for researchers, teachers and software developers for the co-design of TEL environments. It is vital for TEL environments to be designed in consideration of pedagogy and content matters so that the system will possess higher ecological validity and therefore be useful in practice.

References

- Aw, G. P., Quek, G. H., Wong, L.-H., Zhang, X., & Li, Y. (in-press). MyCLOUD: A seamless Chinese vocabulary learning experience mediated by cloud and mobile technologies. In C. S. Chai & C. P. Lim (Eds.), *Future Learning in Primary Schools - A Singapore Perspective*. Singapore: Springer.
- Barab, S., & Squire, K. (2004). Design-based research: Putting a stake in the ground. *Journal of the Learning Sciences, 13*(1), 1-14.
- Brown, A. L. (1992). Design experiments: Theoretical and methodological challenges in creating complex interventions in classroom settings. *Journal of the Learning Sciences, 2*(2), 141-178.
- Chai, C. S., Koh, J., & Tsai, C.-C. (2013). A Review of Technological Pedagogical Content Knowledge. *Educational Technology & Society, 16*(2), 31-51.
- Chan, T.-W., Roschelle, J., Hsi, S., Kinshuk, Sharples, M., Brown, T., . . . Hoppe, U. (2006). One-to-one technology-enhanced learning: An opportunity for global research collaboration. *Research and Practice in Technology-Enhanced Learning, 1*(1), 3-29.
- Chen, H.-R., & Huang, H.-L. (2010). User acceptance of mobile knowledge management learning system: Design and analysis. *Educational Technology & Society, 13*(3), 70-77.
- Cox, S., & Graham, C. R. (2009). Using an elaborated model of the TPACK framework to analyze and depict teacher knowledge. *TechTrends, 53*(5), 60-69.
- Hair, J. F. J., Black, W. C., Babin, B. J., Anderson, R. E., & Tatham, R. L. (2010). *Multivariate data analysis: A global perspective (7th ed.)*. Upper Saddle River, NJ: Pearson Education.
- Hwang, G.-J., Tsai, C.-C., & Yang, S. J. H. (2008). Criteria, strategies and research issues of context-aware ubiquitous learning. *Educational Technology & Society, 11*(2), 81-91.
- Laferrière, T., Hamel, C., & Searson, M. (2013). Barriers to successful implementation of technology integration in educational settings: a case study. *Journal of Computer Assisted Learning, 29*(5), 463-473.
- Lightbown, P. M., & Spada, N. (2013). *How Languages are Learned (4th ed.)*. Oxford: Oxford University Press.
- Liu, Y., Goh, H. H., & Zhang, D. (2006). [A preliminary description of Singaporean Chinese language classrooms]. *[Chinese Teaching of the World]*(1), 97-105.
- Looi, C.-K., & Wong, L.-H. (2013). Designing for seamless learning. In R. Luckin, P. Goodyear, B. Grabowski & N. Winters (Eds.), *Handbook of Design in Educational Technology* (pp. 146-157): Routledge.
- Milrad, M., Wong, L.-H., Sharples, M., Hwang, G.-J., Looi, C.-K., & Ogata, H. (2013). Seamless learning: An international perspective on next generation technology enhanced learning. In Z. L. Berge & L. Y. Muilenburg (Eds.), *The Handbook of Mobile Learning* (pp. 95-108). New York: Routledge.
- Min, G. (2006). Vygotsky sociocultural theory and the role of input and output in second language acquisition. *CELEA Journal, 29*(4), 87-92.
- Mishra, P., & Koehler, M. J. (2006). Technological pedagogical content knowledge: A framework for integrating technology in teacher knowledge. *Teachers College Record, 108*(6), 1017-1054.
- Tedick, D. J., & Walker, C. L. (2009). From theory to practice: how do we prepare teachers for second language classrooms?. *Foreign Language Annals, 28*(4), 499-517.
- Widdowson, H. (2003). *Defining Issues in English Language Teaching*. Oxford: Oxford University Press.
- Wong, L.-H. (2012). A learner-centric view of mobile seamless learning. *British Journal of Educational Technology, 43*(1), E19-E23.
- Wong, L.-H. (2013). Enculturating self-directed learners through a facilitated seamless learning process framework. *Technology, Pedagogy and Education, 22*(3), 319-338.
- Wong, L.-H., Chai, C. S., & Aw, G. P. (in-press). What seems do we remove in learning a language: Towards a Seamless Language Learning framework. In L.-H. Wong, M. Milrad & M. Specht (Eds.), *Seamless Learning in the Age of Mobile Connectivity*: Springer.
- Wong, L.-H., Chai, C. S., Aw, G. P., & King, R. (in-press). Enculturating seamless language learning through artifact creation and social interaction process. *Interactive Learning Environments*.
- Wong, L.-H., Chin, C.-K., Tan, C.-L., & Liu, M. (2010). Students' personal and social meaning making in a Chinese idiom mobile learning environment. *Educational Technology & Society, 13*(4), 15-26.
- Wong, L.-H., & Looi, C.-K. (2011). What seems do we remove in mobile assisted seamless learning? A critical review of the literature. *Computers & Education, 57*(4), 2364-2381.
- Wu, W.-H., Chen, W.-F., Wang, T.-L., & Su, C.-H. (2008). Developing and evaluating a game-based software engineering educational system. *International Journal of Engineering Education, 24*(4), 681-688.
- Zhang, B. H., Looi, C.-K., Seow, P., Chia, G., Wong, L.-H., Chen, W., . . . Norris, C. (2010). Deconstructing and reconstructing: Transforming primary science learning via a mobilized curriculum. *Computers & Education, 55*(4), 1504-1523.

A2I: A Model for Teacher Training in Constructive Alignment for Use of ICT in Engineering Education

Jayakrishnan Madathil Warriem^{a*}, Sahana Murthy^a & Sridhar Iyer^b

^a*IDP in Educational Technology, IIT Bombay, India*

^b*Department of Computer Science and Engineering, IIT Bombay, India*

*jayakrishnan.m@iitb.ac.in

Abstract: The outcome-based approach of education requires engineering faculty to be able to align the student learning objectives with their instructional and assessment strategies. With the increasing use of educational technology, faculty technology integration also becomes an essential part of this alignment. Though there exists instances of training programmes that help faculty to achieve this alignment and integration, there are no validated frameworks or models that will enable teacher educators to prepare good instructional development programmes for the faculty. Attain-Align-Integrate (A2I) is a model for teacher educators to create short-term training programmes (STTP) to achieve constructive alignment in use of Information and Communication Technology. In this paper we describe the model, its key features, then the instantiation of the model as a STTP. Following this, the evaluation of the STTP is described to explain the utility of the model for attaining faculty professional development goals. The results of STTP indicate that participants have shifted from a teacher-centric instructional strategy to a student-centered one, however they require more practice in the alignment to integrate it completely within their teaching learning environment.

Keywords: Teacher Training Model, Constructive Alignment, Technology Integration, Short Term Training Program, Engineering Education

1. Introduction

The engineering education system in India is affected with issues of decline in student as well as teacher quality (Bloom and Saeki, 2012). There exist numerous examples of teacher training programmes across the world, tailored in content and implementation (Dettori & Forcheri, 2003), to address the performance gap. Due to the wide differences in the operating contexts of these programs, their implementation designs are not suitable for direct adaptations. Thus there is a need for a validated framework or model for short-term teacher training program designs (Felder et.al., 2011). The proposed Attain-Align-Integrate (A2I) teacher-training model has been developed to address this problem. The major goals of this paper are: (a) To describe this model for designing short-term teacher training programme (STTP) that combines student-centered approaches with instructional alignment, and (b) Evaluate the STTP that emerged out the model for the learning and change in perception of faculty.

The A2I model consists of 3 phases - Attain, Align and Integrate, aimed at improving the knowledge of faculty in combining instructional alignment with student constructivist approaches, or constructive alignment (Biggs, 1996), within their course. The model prescribes creation of activity slices, for the programme design, that are sequenced based on the focus of individual phase and programme content-specific learning objectives. The complete description of the model along with an example of its implementation is provided in section 3.

A total of 23 participants, from the Electrical, Electronics, Computer Science and Mathematics domain attended the programme. Session worksheets, lesson plan, questionnaire survey, and focus group discussions were used as instruments to evaluate the programme. The following are the investigated research questions:

1. How did the participants fare in the alignment and integration of modules?
2. What are the perceived changes in teaching practices as a result of the workshop?

The results of evaluation showed that more than half the participants obtained medium or higher scores (4-9) in the alignment modules within training. The mean scores of instructional strategies and learning objectives (1.73 out of 3) were better compared to the modules involving assessment strategies. Also, participants started using student-centered teaching-learning strategies within their lesson plans as against the traditional lecturing. This hinted at a conscious shift of the faculty towards student-centered strategies for achieving better student learning outcomes. The results from STTP evaluation led us to conclude that A2I model provides teacher educators with a robust solution for quicker adaptations.

2. Related Work

There is an increasing need for faculty development programmes to focus on the alignment between domain content with assessment and instructional activities to help them engage in scholarly teaching (Stevler et. al., 2012). This is found to be both challenging and time consuming (Conole & Fill, 2005). The typical implementation of these programmes may be in the form of workshops/short-term training programmes, seminars, courses, mentoring etc. (Dettori & Forcheri, 2003;Felder et.al, 2011). There also exist longer faculty technology integration training projects like Communities of Designers, developed from generic framework of Technology Pedagogy and Content Knowledge (Mishra et. al., 2007).

The Course Design and Teaching Workshop at McGill University and National Effective Teaching Institute Program (NETI) at North Carolina University are two short-term training programmes (STTP) that specifically target the alignment. The former workshop employs the design of alignment of learner outcomes, instructional strategies and evaluation to redesign an instructor's own course (Saroyan, et al., 2004). The content of this workshop include modules like concept mapping and active learning strategies to empower the faculty. The NETI workshops focus on learning styles, outcomes, research based instructional strategies and evaluation, and are organized in two stages – NETI I (basic) and NETI II (advanced) (Brent and Felder, 2009). Within the Indian context, it is seen that National Institute of Technical Teacher Training have developed a programme for civil engineering educators (NITTRC, 2013) targeting alignment.

All the programmes discussed in previous paragraph recommend the professional development to start from an authentic teaching-learning problem. The Course Design workshop at McGill comes closest to our requirement of an STTP focusing on alignment. However the workshop implementation process requires months of prior coordination with participants before the actual start of the STTP (Saroyan and Amundsen, 2004). The NETI workshop process also have a time gap of 6 months between the basic and advanced levels, rendering it difficult to adapt. Thus there is an absence of validated teacher training models that allow quick adaptations into a short-term instructional development design programme (Felder et. al, 2011). The A2I model is proposed to address this gap. The model contains the three modules of Learning Objective, Instructional Strategy and Assessment distributed across three phases and is situated within the teaching-learning problem of the faculty. Technology Integration is considered as part of instructional strategy while designing the model.

3. A2I Model

The major goals of the training programme are: (a) To introduce research based student centric strategies that can be implemented by the faculty within their classroom. (b) To train the faculty in aligning Student Learning Objectives with Instructional strategies and Assessment. (c) To train faculty in technology integration with available resources in their classroom.

The main theoretical basis of the model is the idea of constructive alignment. Constructive alignment is achieved when the teaching learning activities and evaluation are aligned with the intended student learning outcomes (Biggs, 1996). The model incorporates the constructive alignment by (a) Selecting Learning Objectives, Instructional Strategies and Assessment Strategies as explicit contents and (b) Providing three phases of Attain-Align-Integrate that allows for knowledge of alignment between these contents. Research cites that constructive alignment has been successfully employed by faculty in course redesign and promotes deep learning among students (Wang et. al., 2013). The major contents are then dealt with using a spiral curriculum i.e. an iterative process of

revisiting the contents, with successive iterations looking at the topic in a greater depth for the learner to build on his initial understanding.

3.1 Features of A2I Model

The entire model (see Table 1) consists of the following design components:

Table 1: A2I model for Constructive Alignment in use of ICT

Phase	Focus	Module		Format	Output
		Topic	Learning Objectives		
Attain	Introduction to concepts	Learning Objective - Sub Topics Instructional Strategy - Sub Topics Assessment Strategy - Sub Topics	Write phase wise learning objectives that focus on concept attainment.	Majority are Instructor led activity slices.	Identification of an LO, IS and AS relevant to their own course.
Align	Depth in Concepts and Intro to Alignment		Write Phase Learning Objectives that will help participants align learning in the modules pairwise.	Majority are Participant driven individual activity slices.	Examples of pairwise aligned modules in their course
Integrate	Depth in Alignment		Write Phase Learning Objectives that will help participants integrate learning from the three modules.	Most of the activities are Participant driven collaborative slices.	An Integrated Lesson Plan for one lecture within their course.

- *Phases* - There are three phases viz., Attain, Align and Integrate that is based on the various contents at differing depth.
 - In the attain stage, the workshop designer will have to concentrate on the participant attaining preliminary knowledge on the three core modules of Learning Objectives, Instructional Strategies and Assessment Strategies. The alignment phase of the workshop looks at pairwise alignment between the modules. The integration phase workshop looks at the constructive alignment of the three modules.
- *Focus* - This column specifies the focus of the designed activities in each phase.
- *Module* - This column deals with content dealt within the phase. It is further subdivided into
 - Topics and Subtopics - This specifies the various sub-topics dealt under the three main modules of Learning Objective, Assessment Strategy and Instructional Strategy.
 - Learning Objectives - This specifies the topic level learning objectives.
- *Format* - This refers to the way sessions are held. The detailed split up of format is provided in Table 2 below. A single session comprises of several activity slices that involve specific actions by the instructor and participant during the teaching-learning interactions. There are 3 main types of activity slices viz., Instructor Driven, Participant Driven Individual, Participant Driven Collaborative. The role of participant varies from a learner to that of a teacher across the various slices as shown in Table 2. The duration of an activity slice is also a key aspect, as studies show that the average attention span of an adult learner is nearly 20 minutes (Dukette & Cornish, 2009), which necessitates the span of instructor led activities to be lesser.
- *Output* - This specifies the tangible output at the end of each phase, which provides the learner with flexibility in application and the needed reflection on outcomes.

3.2 Implementation of A2I model

The implementation of Attain phase for learning objective module is explained as an example. The module contained two sub-topics – What and Why of Learning objective. These sessions – a) explained the need for learning objective, and b) distinguished appropriate and inappropriate learning objectives. The total session spanned for 30 minutes with 5 activity slices. The first two activity slices spanned 15 minutes with more of Instructor led activities with participants being active learners. These were followed by three 5-minute slices of participant driven individual, collaborative and instructor led summary activities.

Table 2: Elaboration of Format within A2I model

Activity Slice	Examples	Role of Participant	Duration
Instructor Driven (In)	Instructor presenting the content to the participants. Instructor summarizing the content to participant	Learner	Between 5~15 minutes.
Participant Driven Individual (PIIn)	Participant writing examples in worksheets meant for pairwise alignment. Participant performing a microteaching activity with visualizations.	Teacher	Between 5~10 minutes.
Participant Driven Collaborative (PCo)	Participants collaborating to write a lesson plan for a single lecture. Participants involved in Think-Pair-Share activity for aligning instructional strategies with learning objectives.	Shuttles between Learner and Teacher	Maximum of 45 minutes.

4. Evaluation

The evaluation of the programme is done at the two levels of Learning and Behaviour (Kirkpatrick, 2006). This is supported by reactions of participants to the programme, evaluated through a questionnaire survey. A positive result would imply that an instantiation of the model has achieved them and thus provide validation for the model. The research questions for evaluating each of these constructs are:

RQ 1. How did the participants fare in the alignment and integration of modules? (Learning)

RQ 2. What are the perceived changes in teaching practices as a result of the workshop? (Behaviour)

The total number of participants was 23 and the sample for each analysis was chosen from this population based on the number of submissions of lesson plans, worksheets and survey forms. We have used a questionnaire survey and focus group discussions to capture the participant perceptions about the various aspects of the workshop. The questionnaire survey consisted of 24 questions divided into three sections - Design, Learning and Application, and was administered at the end of the workshop. 21 participants had responded to this survey and these were considered for the analysis. The questions used for analysis had a 5-point Likert Scale from Strongly Disagree to Strongly Agree. A question like “ I intend to explicitly specify Learning Objective for my class.” directly captured the behavior of the participant at the end of workshop.

The evaluation also utilized lesson plan created in the integrate phase and technology integration worksheet created in the align phase. We analyzed the data of all participants who had submitted their worksheet using a custom evaluation rubric. The rubric consisted of 6 dimensions and 4 scales. Two raters were trained for the evaluation and the rubric had substantial inter-rater reliability ($k=0.7$) for two raters, after training. The workshop session on visualization had an individual worksheet in which participants had to write the visualization integration plan for achieving learning objectives in their chosen topic. This was also evaluated using the lesson plan rubric. After the completion of this

worksheet, participants performed a microteaching activity to explain their proposed visualization integration strategy to the others.

5 Results

As seen in Table 3, the participants have displayed sufficient mastery in individual modules of Learning Objective and Assessment Strategy with a mean score of 1.95 and 1.76 (out of 3) respectively. The participants are also performing better in the alignment of these two modules with a mean score of 1.76 (out of 3). This means that they would require more training within the alignment.

Table 3: Mean Scores for Attain and Align phases

Module	ATTAIN			ALIGN		
	Learning Objective (LO- 3)	Instructional Strategy (IS – 3)	Assessment Strategy (AS-3)	LO-IS (3)	LO-AS (3)	AS-IS (3)
Mean Score	1.95	1.76	1.19	1.76	1.14	1.19

The technology integration scores (in Table 4) also shows that more than half of the participants were able to score at least 2 out of 3, which gives a mean score of 1.67. This is giving a similar result of alignment as the LO-IS column in Table 3. Within the questionnaire survey, the participants have indicated high perceptions on learning about alignment but a common response in all 3 group discussions was that “ [they] require more practice sessions to check whether what [they] are doing is right or not”.

Table 4: Technology Integration Score

Rubric Scale	Missing (0)	Inadequate (1)	Needs Improvement (2)	Adequate (3)	Mean Score
Participants	3	3	9	3	1.67

In the questionnaire survey administered immediately after the workshop almost all the participants have positively agreed on their intent to implement learning within the workshop. 18 different participants had indicated their intention of using active learning strategies of Think-Pair-Share and Peer Instruction within their classroom. The analysis of the final lesson plans showed that 18 of the participants had also used these active learning strategies. This confirms a clear change in the mindset of the participants to consciously include student-centered approaches in their teaching-learning practices. Table 5 compares the data corresponding to the reported intentions to use strategies and actual use of strategies within the lesson plans. This shift was evident in the responses during the focus group discussions in which one group clearly identified that “[they] have to break the traditional way of teaching so that students can connect”. The discussion also had a larger share of participants opting for Peer Instruction as a possible choice over Think-Pair-Share. All of them had a strong buy-in to use ICT in the class in the form of visualizations.

Table 5: Intentions of use of Instructional strategy Vs. Actual strategies used in Lesson Plan

Strategy	Think-Pair-Share	Peer-Instruction	Visualization
Intended (Actual) Use	12(10)	18(13)	12 (8)

6 Discussion and Conclusion

While answering the learning gains from the workshop, it is seen that participants show better gains at the attainment of individual modules. Higher scores are reported for alignment of instructional strategy and learning objectives (Mean score of 1.76 and 1.67 for Lesson Plan and

Technology Integration). This means that the programme fared better in alignment considering the challenges with short time duration reported in literature (Conole & Fill, 2005). In the current workshop, participants had opportunity to practice the alignment of instructional strategies with learning objectives during the microteaching activity. This might have had a positive effect on those alignment scores. But more importantly this also informs the future implementations of the A2I model to provide explicit practice for alignment of assessment strategies with the other two modules.

The second research question on the changes in faculty behavior was seen from the match between the actual uses of same strategies in the lesson plan with the numbers reported in the post-workshop survey. 18 participants had used active learning strategies within their lesson plan and also indicated the intention to use these in classroom in the post-workshop survey and focus group discussions. This confirms a conscious shift of the faculty behaviour towards student-centeredness as demanded by constructive alignment theory (Biggs, 1996).

Successful implementation of the training programme and the positive results in both learning and behavior indicates that A2I model can be utilized for designing teacher-training programmes in constructive alignment for use of ICT in engineering education. For faculty training programmes in Electrical, Electronics, Computer Science and Mathematics, the examples and design of the current STTP can be directly used. For other domains, the activity slices have to be modified based on examples relevant to those domains. The smaller participant strength and constraints for verification of actual classroom practices are two major limitations of this study.

Acknowledgements

We would like to thank all the research scholars and staff within our department who helped us during the design and implementation of this programme.

References

- Biggs, J. (1996). Enhancing Teaching through Constructive Alignment. *Higher Education* , 32, 347-364.
- Blom, A., & Saeki, H. (2012). Employability and Skill Sets of Newly Graduated Engineers in India: A Study. *The IUP Journal of Soft Skills* , 6 (4), 7-50.
- Brent, R., & Felder, R. M. (2009, June). Analysis of fifteen years of the national effective teaching institute. In *Proc. 2009 Ann. ASEE Conf.*
- Conole, G., and Fill, K. (2005). A learning design toolkit to create pedagogically effective learning activities. *Journal of Interactive Media in Education*, 8(08), 2.
- Desimone, L. M. (2009). Improving Impact Studies of Teachers' Professional Development: Toward Better Conceptualizations and Measures. *Educational Researcher* , 38 (3), 181-199.
- Dettori, G., & Forcheri, P. (2003). A Retrospection on ICT in Teacher Education: What can we learn? In A.Méndez-Vilas, & J. González (Ed.), *2nd Internat. Conf. on Multimedia and ICT in Education* , (pp. 17-21). Badajoz.
- Dukette, D., and Cornish, D. (2009). *The Essential 20: Twenty Components of an Excellent Health Care Team*, pp 72-79, Dorrance Publishing.
- Felder, R. M., Brent, R., & Prince, M. J. (2011). Engineering instructional development: Programs, best practices, and recommendations. *Journal of Engineering Education*, 100(1), 89-122.
- Kirkpatrick, D.L., & Kirkpatrick, J.D. (2006), *Evaluating Training Programs, 3rd Edition*, San Francisco, USA; Berrett Koehler Publishers.
- Mishra, P., Koehler, M. J., & Zhao, Y. (2007). Communities of Designers. In P. Mishra, M. J. Koehler, & Y. Zhao (Eds.), *Faculty Development by Design: Integrating Technology in Higher Education* (pp. 1-22). Charlotte, NC, USA: Information Age Publishing.
- NITTRC. (2013). *National Institute of Technical Teachers Training and Research*. Retrieved March 2014, from http://nittrc.ac.in/files/Engineering_colleges_brochure_2013-14.pdf
- Saroyan, A., Amundsen, C., Weston, C., McAlpine, L., Winer, L., Cowan, S., et al. (2004). The Course Design and Teaching Workshop: Why and What? In A. Saroyan, & C. Amundsen (Eds.), *Rethinking Teaching in Higher Education: From a Course Design Workshop to Faculty Development Framework* (pp. 3-14). Sterling, Virginia, USA: Stylus Publishing LLC.

Wang, X., Su, Y., Cheung, S., Wong, E., & Kwong, T. (2013). An exploration of Biggs' constructive alignment in course design and its impact on students' learning approaches. *Assessment and Evaluation in Higher Education*, 38 (4), 477-491.

Analytical Evaluation of Technology Acceptance in Teachers Training of Primary Mathematics Education in Hong Kong: A Preliminary Study

Gary K. W. WONG^{a*}, Ho-Yin CHEUNG^b

^{a,b}Department of Mathematics and Information Technology,
The Hong Kong Institute of Education, Hong Kong, China

*wongkawai@ied.edu.hk

Abstract: Digital technologies have been introduced for the purpose of enhancing the learning and teaching effectiveness, and many tools are designed specifically for mathematics education. However, whether pre-service teachers will actually intend to adopt the software or not in their future workspace is an important question. Even if they do, it is important to study the reasons behind their decision in this particular local context, and how the training curriculum can assist them in fulfilling their teaching goals. In this paper, our aim is to study the technology acceptance of our pre-service teachers in primary mathematics education, and investigate the incentives behind their decision of adoption in our local context based on their technology-enhanced learning experience in our Institute. Using multiple-regression analysis, we examine the factors influencing the technology acceptance of the pre-service teachers in their future teaching career. Our goal is to provide preliminary insights into how technology is perceived by these pre-service teachers in mathematics education training and career. This insight will help us build a better analytical model for a more formal analysis in our future study that fits both local and global contexts.

Keywords: Technology acceptance; TAM; UTAUT; Teachers training; Mathematics education; Multiple-regression analysis

1 Introduction

Educational technology is a core part of the mathematics teacher education curriculum in our Institution. Students (pre-service teachers) often come up with innovative ideas in their lesson plan, yet apparently only a few intend to actually put these into practice in their future teaching. Our experience working with in-service teachers also turns to a similar observation. It is therefore our interest to understand their concerns in order to inform the design of an effective teacher education curriculum.

This paper reports part of our larger study to identify the factors of technology acceptance for both pre-service teachers and in-service primary mathematics teachers in our local context. For each case, an explanatory mixed method approach (Creswell & Clark, 2006) is adopted to study the participants' concerns firstly by quantitative survey, and then secondly by in-depth qualitative interviews with selected participants to gain deeper understanding behind the statistics. Research in this area has been conducted mostly in the higher education setting (see, e.g. the meta-analyses in (Schepers & Wetzels, 2007; Šumak, Heričko, & Pušnik, 2011; Taiwo & Downe, 2013)), while to our best knowledge very little ongoing research has been done in the primary education sector especially in Hong Kong. Through our initiative efforts, the outcomes will inform the curricular design of pre-service teacher training programs and inspire further research in this area.

This paper covers the preliminary results of the quantitative survey with pre-service teachers. Background literatures are presented in Section 2, research methodologies in Section 3, and data analysis and discussion in Section 4. We will then conclude the paper and lay out the roadmap for future works in Section 5.

2 A Brief Description of Related works

The majority of existing studies in the area of technology acceptance take the approach of multi-variable quantitative analysis, which starts with a hypothetical model describing the relations among possible factors of technology acceptance. These studies consist of statistically testing the model using survey data in that particular context. Two popular models of this type are the Technology Acceptance Model (TAM) (Davis, 1985) and its successor, the Unified Theory of Acceptance and Use of Technology (UTAUT) (Venkatesh, Morris, Davis, & Davis, 2003).

Early empirical studies following the TAM suggest that perceived usefulness and perceived ease of use of the technology are the fundamental determinants of the teachers' behavior intention to use the technology (Davis, 1989). These in turn depend on other factors such as computer self-efficacy and attitude towards computer (see, e.g. (Teo, 2010)). However, subsequent studies show that the results may not be that conclusive on change of context (Scheepers & Wetzels, 2007). Recently, a meta-analysis of 37 studies using UTAUT show that only the perceived usefulness (renamed as performance expectancy in the model) has a strong relation with behavioral intention, while all the other factors are weak although statistically significant (Taiwo & Downe, 2013). In fact, most of the studies in the literature have been conducted in the Western context, while there is evidence that their results are possibly not be generalizable to non-Western contexts. For example, Yuen and Ma report that perceived usefulness is insignificant among 152 student teachers in a part-time teacher education programme in Hong Kong (Yuen & Ma, 2008). Similarly, Lai et. al. studied 264 undergraduate students in Hong Kong and found that perceived usefulness only had marginal significance (Lai, Wang, & Lei, 2012). This could be a cultural phenomenon demonstrated by non-Western users, but no further analysis has been conducted on top of the results to verify this claim.

3 Methodology

The present preliminary study aims to analyze the technology acceptance of a group of pre-service teachers studying primary mathematics education at the Hong Kong Institute of Education. The questionnaire begins with a statement defining educational technology as any digital computer technology that could assist teaching either in the classroom or in after-class learning activities, but excluding usage in teaching preparation or administrative tasks. The questions consist of two parts. The first part (see [Table 1](#)) consists of items used in TAM and UTAUT studies to collect the participants' perceptions on eight constructs related to technology acceptance, namely, Perceived Usefulness (PU), Perceived Ease of Use (PEU), Attitude (ATT), Social Influence (SI), Facilitating Conditions (FC), Self-Efficacy (EFF), and Anxiety (ANX), with minimal customization to fit into our specific context. The second part asks other general information about the participants, including their gender, year of birth, their experience of using educational technologies, whether or not they are willing to take part in the follow-up interviews of the study, etc.

Table 1: Items used in the first part of the questionnaire

Construct	Code	Item
Perceived usefulness (PU)	PU1	I would find educational technology useful in my teaching.
	PU2	Using educational technology enables me to accomplish teaching tasks more quickly.
	PU3	Using educational technology increases my productivity (i.e. accomplishes more with less effort and time).
	PU4	Using educational technology will increase my chances of getting a promotion.
Perceived ease of use (PEU)	PEU1	My interaction with educational technology would be clear and understandable.
	PEU2	It would be easy for me to become skillful at using educational technology.
	PEU3	I would find educational technology easy to use.

Attitude (ATT)	PEU4	Learning to use educational technology is easy for me.
	ATT1	Using educational technology is a good idea.
	ATT2	Educational technology makes my work more interesting.
	ATT3	Educational technology is fun.
Social Influence (SI)	ATT4	I like using educational technology in teaching.
	SI1	I believe that people who influence my behavior will think that I should use educational technology.
	SI2	I believe that people who are important to me will think that I should use educational technology.
Facilitating conditions (FC)	SI3	I believe that the school will support the use of educational technology.
	FC1	I believe that I will have the resources necessary to use educational technology.
	FC2	I have the knowledge necessary to use educational technology.
	FC3	I believe that a specific person or group (e.g. technical support team) will be available for assistance with difficulties using educational technology.
Computer self-efficacy (EFF)		I could complete a job or task using educational technology...
	EFF1	... even if there was no one around to tell me what to do as I go.
	EFF2	... if I could call someone for help if I got stuck.
	EFF3	... if I had enough time.
Anxiety (ANX)	EFF4	... if I had access to the instruction manuals for the technology.
	ANX1	I fear about using educational technology.
	ANX2	It scares me to think that I could ruin my teaching using educational technology by making a small mistake.
	ANX3	I hesitate to use educational technology for fear of making mistakes I cannot correct.
Behavioral intension of use (BI)	ANX4	Educational technology is somewhat frightening to me.
	BI1	I intend to use educational technology in my future teaching.
	BI2	I predict I would use educational technology in my future teaching.
	BI3	I have actual plan to use educational technology in my future teaching.

Instead of using the structural equation modeling (SEM) approach in TAM and UTAUT, we use a multiple-regression model as follows: First, an initial model is formulated, named R0, which assumes that behavioral intention (BI) to use technology is a linear function of all the other seven constructs. Moreover, as inspired by UTAUT, gender (GDR) is considered a moderator of perceived ease of use, social influence, and perceived usefulness, while experience (EXP) is considered a moderator of perceived ease of use, social influence, and facilitating conditions. Both moderators are included as categorical variables in the linear equation. Experience is classified as either low, medium, or high according to the students' past exposure to educational technologies. Next, stepwise regression (Hocking, 1976) is applied to eliminate variables from the initial model by minimizing its AIC (Akaike, 1974). The resulting model is named R1 and the coefficients are used to identify the important constructs. This approach of variable selection is only possible in multiple-regression. Although not as sophisticated as SEM, it allows us to examine different variants of the model empirically to find alternative models that better fit the data and are still theoretically reasonable. This insight will help us build more reasonable models for our next stage of study using SEM.

4 Results And Analysis

4.1 Results of the Responses

A total of $n=166$ valid observations were collected in the study. For the final model R1 consisting of 10 independent variables, this exceeds the rule of thumb suggested by Tabachnick & Fidell (2012) requiring at least $50 + 8 \times 10 = 130$ observations for regression. The corresponding student gender profile is tabulated in [Table 2](#), and the experience profile in [Table 3](#). Descriptive statistics of the constructs are given in [Table 4](#). Inspection of

the box plot of these distributions shows that they are not exactly normally distributed but all follow a bell shape. We will therefore use the data as-is without transformation.

Table 2: Gender profile

	Year of Studies				
	Year 1	Year 2	Year 3	Year 4	Total
Female	28	72	12	7	119
Male	18	21	2	6	47
Total	46	93	14	13	166

Table 3: Experience profile

	Year of Studies				
	Year 1	Year 2	Year 3	Year 4	Total
EXP(Low)	18	32	8	2	60
EXP(Medium)	20	33	4	2	59
EXP(High)	8	28	2	9	47
Total	46	93	14	13	166

Table 4: Descriptive statistics of UTAUT constructs

Construct	Mean	Standard deviation	Construct	Mean	Standard deviation
PU (Perceived Usefulness)	3.74	0.60	FC (Facilitating Conditions)	3.61	0.60
PEU (Perceived Ease of Use)	3.55	0.76	EFF (Self-Efficacy)	3.67	0.58
ATT (Attitude)	3.81	0.67	ANX (Anxiety)	2.72	0.85
SI (Social Influence)	3.48	0.61	BI (Behavioral Intention to Use)	3.59	0.68

The resulting R1 model explains 56.39% of the variation in BI. The variables included in both models, as well as the R1 coefficients and their statistical significance are indicated in Table 5. Coefficients with p-value greater than or equal to 0.05 are marked as “N/S” (not significant) in the table.

Table 5: Model specifications and R1 regression coefficients (*: p<0.05, **: p<0.01, ***: p<0.001)

R0	R1	Results	R0	R1	Results
(Intercept)	(Intercept)	N/S	EXP(Medium) x PEU		
PU	PU	0.30***	EXP(Medium) x SI		
PEU	PEU	N/S	EXP(Medium) x FC	EXP(Medium) x FC	N/S
ATT	ATT	0.34***	EXP(Low) x PEU		
SI			EXP(Low) x SI		
FC	FC	N/S	EXP(Low) x FC		
EFF	EFF	0.25***	GDR(M)	GDR(M)	0.16*
ANX			GDR(F)		
EXP(High)	EXP(High)	1.69**	GDR(M) x PU		
EXP(Medium)	EXP(Medium)	N/S	GDR(M) x PEU		
EXP(Low)			GDR(M) x SI		
EXP(High) x PEU			GDR(M) x PU		
EXP(High) x SI			GDR(M) x PEU		
EXP(High) x FC	EXP(High) x FC	-0.47**	GDR(M) x SI		

The findings are summarized below:

1. Of the seven constructs considered in the model, only perceived usefulness, attitude, and computer self-efficacy have statistically significant impact on behavioral intention. In particular, perceived ease of use is not proven to be statistically significant.
2. Experience is a strong moderator. High experience increases the intention to use the technology in the future.
3. Male students tend to have slightly stronger intention to use the technology.
4. Interestingly, if a student already has at least one semester of experience using educational technology, better facilitating conditions decrease rather than increase the students' intention to use the technology in the future.

4.2 Discussion

The results that perceived usefulness has a direct impact on behavioral intention while the same is not true for perceived ease of use is in contrary to early typical results under TAM showing that both are statistically significant. The reason is yet to be found out in follow-up interviews, but one possibility is that the pre-service teachers are less concerned with the latter as they are not supposed to face the practical difficulties immediately. Indeed, these pre-service teachers are full-time students, and they are mostly facing challenges only up to the level of fulfilling the requirement of homework assignments or final projects, which are more or less the same with their peers in the same course. Their effort put into using any educational technology is under countable circumstances that they should be able to handle, such as presentation, group projects, or even teaching practicum. Since the curriculum is designed to give initial experience of formal teaching to the students, the effort expected from them is relatively small compared to real workplace. Thus, their perception in using educational technology for their work or study should not be comparable to in-service teachers or others who may constantly find new challenges at work. Yet, we think that the curriculum should be designed so that they can feel similar challenges in learning and using educational technology compared to post-graduation work. Our future work should be able to address these questions in depth.

For those already with some experiences using the technology, the negative relation between facilitating conditions and behavioral intention to use may be explained by their uncertainty in their future working environment and their inadequacy feeling in experiencing with educational technology. Our undergraduate students are only offered with one core course in how to use technology in their teaching mathematics. It could give the students a feeling of unimportance in using educational technology for teaching in the future. This could also explain why they believe they only have some experiences using the technology rather than none or high, and it fails to sustain their assurance in using it for professional work. Nevertheless, this uncertainty perception could be further investigated in our future qualitative work with interviewing these students.

It is also possible that some students misinterpret the questions, leading to error in their responses. While our questionnaire follows closely the design in the original paper by the proposers of UTAUT, which is presented in English, the majority of students in our sample are native Chinese speakers who may not be able to fully understand some of the questions in English as a second language. They may even hesitate to ask our assistants when they do not understand the questions in order not to project a bad image. One possible measure to take is to translate the questionnaire into Chinese using a back-translation process (Brislin, 1970). Some authors have shown that the UTAUT is robust enough to be used with translated questionnaire (Oshlyansky, Cairns, & Thimbleby, 2007). However, due to time constraint we have used the original English version instead.

5 Conclusions and Future Works

In this paper, our aim is to study the technology acceptance of our pre-service teachers in primary mathematics education, and investigate the incentives behind their decision of adoption in our local context. To the best of our knowledge, this is the first work undertaken in our Institute to study the perception of our students, who will soon serve as the major group of local teachers in primary mathematics sector. Understanding their perspective in technology-enhanced pedagogy is significant to the design of any advanced learning technology that is suitable

for their teaching. Our future work will attempt to further investigate their tendency in using educational technology with a more formal model, and study the reasons behind their choices through qualitative approaches.

6 Acknowledgment

This project is supported by the Small Research Grant 2013/14 from the Department of Mathematics and Information Technology in the Hong Kong Institute of Education.

7 References

- Akaike, H. (1974). A new look at the statistical model identification. *IEEE Transactions on Automatic Control*, 19. doi:10.1109/TAC.1974.1100705
- Brislin, R. W. (1970). Back-Translation for Cross-Cultural Research. *Journal of Cross-Cultural Psychology*. doi:10.1177/135910457000100301
- Creswell, J. W. D., & Clark, V. L. P. (2006). Choosing a mixed methods design. In *Designing and conducting mixed methods research* (1st ed., pp. 58–89). Sage Publications, Inc.
- Davis, F. D. (1985). *A Technology Acceptance Model for Empirically Testing New End-user Information Systems: Theory and Results*. Massachusetts Institute of Technology.
- Davis, F. D. (1989). Perceived Usefulness, Perceived Ease of Use, and User Acceptance of Information Technology. *MIS Quarterly*, 13(3), 319–340.
- Hocking, R. R. (1976). The Analysis and Selection of Variables in Linear Regression. *Biometrics*, 32, 1–49. doi:10.2307/2529336
- Lai, C., Wang, Q., & Lei, J. (2012). What Factors Predict Undergraduate Students' Use of Technology for Learning? A Case from Hong Kong. *Computers & Education*, 59(2), 569–579.
- Oshlyansky, L., Cairns, P., & Thimbleby, H. (2007). Validating the Unified Theory of Acceptance and Use of Technology (UTAUT) tool cross-culturally. *Proceedings British Computer Society HCI 2007 Conference*, 2(September), 83–86.
- Schepers, J., & Wetzels, M. (2007). A meta-analysis of the technology acceptance model: Investigating subjective norm and moderation effects. *Information & Management*, 44(1), 90–103.
- Šumak, B., Heričko, M., & Pušnik, M. (2011). A meta-analysis of e-learning technology acceptance: The role of user types and e-learning technology types. *Computers in Human Behavior*, 27(6), 2067–2077. doi:10.1016/j.chb.2011.08.005
- Tabachnick, B. G., & Fidell, L. S. (2012). *Using Multivariate Statistics* (6th ed.). Pearson.
- Taiwo, A. A., & Downe, A. G. (2013). The theory of user acceptance and use of technology (UTAUT): a meta-analytic review of empirical findings. *Journal of Theoretical and Applied Information Technology*, 49(1).
- Teo, T. (2010). A Path Analysis of Pre-Service Teachers' Attitudes to Computer Use: Applying and Extending the Technology Acceptance Model in an Educational Context. *Interactive Learning Environments*, 18(1), 65–79.
- Venkatesh, V., Morris, M. G., Davis, G. B., & Davis, F. D. (2003). User Acceptance of Information Technology: Toward a Unified View. *MIS Quarterly*, 27(3), 425–478.
- Yuen, A. H. K., & Ma, W. W. (2008). Exploring Teacher Acceptance of e-learning Technology. *Asia-Pacific Journal of Teacher Education*, 36(3), 229–243.

Assessing computer attitudes: Does it matter for teacher education in developing countries?

Su Luan WONG

Faculty of Educational Studies, Universiti Putra Malaysia, Malaysia

*suluan@upm.edu.my

Abstract: The digital education revolution has had a significant impact on the teaching-learning environments. In this new era, it is unimaginable to have technology illiterate teachers in classrooms. The demand for education reform in most developing countries has been growing ever since to ensure that teachers are equally proficient in both computer technology competencies and pedagogical content knowledge. The success of such educational reforms also relies on teachers' attitudes and willingness to embrace computer technologies in the learning environment. To cope with these expectations, teacher training institutions should include computer related attitudinal objectives in their teacher training programmes. This paper explores the issues surrounding the assessment of computer attitudes among teachers and student teachers with the view whether such assessment matters in teacher education. The focus of this paper is guided by three relevant questions—"What is computer attitudes?", "What affects computer attitudes?", and lastly "Why measure computer attitudes?"

Keywords: Computer attitudes, teacher education, developing countries

1. Introduction

The rapid proliferation of the computer technology in the 21st century has had significant impacts on the teaching-learning environments. Realising the importance of ICT for education, governments in many developing countries have started to take incremental but concrete steps to bring the positive impact of ICT into the classrooms (Southeast Asian Ministers of Education Organization, 2010). For example, the Malaysian government spent almost USD 1.8 billion in the last decade to train teachers to integrate ICT in the classrooms and also to equip schools with adequate ICT infrastructures. The Malaysian Ministry of Education aims to improve the ICT device-to-student ratio from about 1:30 in 2011 to 1:10 by 2020 (Ministry of Education, 2012). In 2001, Vietnam announced its Master Plan for ICT in education for the year 2001-2005 which emphasised on infrastructural development and IT training (Peeraer & Van Petegam, 2011). The aforesaid initiatives are a testament to the growing concerns of developing countries in bridging the digital gap in schools.

As we progress into a technology-based society, it is imperative that teaching experiences with computers as effective pedagogical tools are made available to teachers (Teo, Lee & Chai, 2008). For this reason, there is great urgency for teachers to be able to use and integrate ICT effectively in the teaching-learning process. Teachers today need to develop their abilities and feelings of self-efficacy as they integrate computer technologies successfully as a teaching-learning tool (Wong, Jalil, Ayub, Bakar & Tang, 2003). In other words, teachers need to be comfortable with computer technologies and are able to consolidate and innovate their teaching (Heale, 2011).

The demand for education reform has been growing ever since to ensure that teachers are able to teach effectively with computer technologies. Education reforms in most developing countries have emphasised the need to integrate computer technologies into learning, teaching and assessment (Peeraer & Van Petegam, 2011). In fact, moving in tandem with this change, teacher education policies in many developing countries have also been reformed to ensure trainee teachers are equally proficient in both computer technology competencies and pedagogical content knowledge. The success of such

educational reforms relies on teachers' attitudes and willingness to embrace computer technologies in the learning environment (Albirini, 2006). Indeed, Albirini (2006, p.386) stressed that "developing nations have the responsibility not merely to provide computers for schools, but also to foster a culture of acceptance amongst the end-users of these tools".

To cope with these expectations, it is essential for teacher training institutions to include computer related attitudinal objectives in their teacher training programmes so that student teachers develop positive attitudes toward computer technologies. For this reason, the focus of this paper is to answer the question of whether it matters to measure teachers' computer attitudes particularly in developing countries. The focus of this paper is guided by three questions— "What is computer attitudes?", "What affects computer attitudes?", and lastly "Why measure computer attitudes?"

2. What is computer attitudes?

Attitude is considered to be a very important concept from the social psychology point of view mainly because of its importance in social judgements and behaviours (Zhang & Sun, 2009). Attitudes guide behaviour and "favourable attitudes predispose positive responses to the object and unfavourable attitudes predispose negative responses" (Ajzen & Fishbein, 2005, p.17). Ajzen (1988) classified attitude into three distinct categories— affect (reflects feelings toward the attitude object, cognition (reflects perceptions and information about the attitude object) and conation (reflects behavioural intention and action with respect to the attitude object). In an earlier study, Breckler (1984) also confirmed the three dimensional definition of attitudes by testing the tripartite model of attitude structure by Rosenberg and Hovland (1960).

It is widely believed that attitudes is formed after the individual is exposed to an object for a certain period of time. Therefore, it is possible that teachers would have developed some attitudes toward computers when they have been in contact with these tools either for personal or professional use. In the context of computers, Kay (1993) defined computer attitudes by drawing on the definitions proposed by Breckler (1984) and Ajzen (1988). He employed a four dimensional definition of computer attitudes— affect (feelings towards computers), cognition (perceptions of and information about computers), conation (behavioural intentions and action with respect to computers) and perceived behavioural control (perceived ease or difficulty of using computers).

Consistent with Ajzen and Fishbein's (1977) theory, Smith, Caputi and Rawstorne's (2000) defined computer attitudes as a person's general evaluation or feelings of favourableness or unfavourableness towards computer technologies (i.e. attitude towards object) and specific computer-related activities (i.e. attitude towards behaviours). Similarly, Divine, Wilson and Daubek (1997) defined computer attitudes as the level of affect one has for computers while Heinssen, Glass and Knight (1987) defined computer attitudes as people's feelings about the impact of computers on society and the quality of life, and their understanding of computers. Igbaria and Parasuraman (1993) conceptualised it as a representation of individuals' predisposition to react in a certain way toward them.

The aforementioned literature suggests that computer attitudes is a multi-dimensional construct and distinct in nature. However, it also suggests there is no one definite meaning of computer attitudes. There seems to be little consensus on the term used to define computer attitudes. The literature, however, does indicate that any scales intending to measure teachers' computer attitudes should at least constitute one of these dimensions— affective, cognitive, behaviour and behavioural control. Interestingly, assessing feelings toward computers or affection (Heinssen et al., 1987; Divine et al., 1997; Smith et al., 2000) seems to be gaining prominence in recent years (Garland & Noyes, 2008) but Yang and Yoo (2004) stressed that the cognitive dimension should not be ignored as it is just as significant.

3. Why measure computer attitudes?

Salzer and Burks (2003) stressed that it is important to study computer attitudes because it is believed to have either positive or negative impacts on computer related behaviours. They asserted that the need to focus on teachers' computer attitudes is even greater simply because they are responsible to ensure the

future generation are prepared to function adequately in a technological society. They warned that teachers with negative computer attitudes may inhibit their ability to educate students in the use of computers. Computer attitudes is believed to influence not only teachers' acceptance of computers but their future use of computers in the classroom (Roussos, 2007). Teo et al. (2008) stressed that the main reason for assessing teachers' computer attitude is its ability to predict computer usage. In other words, teachers with positive computer attitudes would have higher likelihood of integrating computer technology successfully in their teaching-learning process. Teachers would respond favourably to computer technology use (behaviour) when they possess positive computer attitudes.

This behaviour-attitude relationship stems from the Theory of Reason Action (TRA) by Fishbein and Ajzen (1980) which posits that behavioural intent is a pertinent determinant of behaviour. It also proposes that this intention to perform a behaviour is a combination of attitude toward performing the behaviour and subjective norm. This theory holds that attitudes is key to understanding human behaviour. Researchers have continued to research on computer attitudes and found it to be a significant predictor of behavioural intentions or behaviour. Luan and Teo (2009) reported that computer attitudes had the biggest influence on Malaysian student teachers' intention to use computers in the future while Teo's (2012) study among Singaporean student teachers also reported the same findings. The link between these two variables was also established in an earlier study by Sadik (2006) who provided evidence that the level of school computer use was affected by teachers' computer attitudes in Egypt.

However, in recent years, many researchers have questioned the importance of measuring computer attitudes. There are researchers who strongly believe that attitudes construct is too trivial to be studied and excluded it from their model framework (Ma, Andersson & Streith, 2005). They are convinced that the attitude-behaviour relationship is weak and insignificant. Older and newer studies have shown empirically that computer attitudes does not have any effect on behavioural intention or behaviour (Davis, Bargozi & Warshaw, 1989; Teo, 2009; Nistor & Heymann, 2010). For example, Teo's (2009) findings based on the structural equation modelling's (SEM) suggested that pre-service teachers computer attitudes did not contribute to the total variance accounted for in technology use.

Yang and Yoo (2004), however, disagreed that computer attitude is insignificant. They suggested that Davis and his colleagues' (1989) failure to find attitude to be a significant predictor of behaviour may have been due to the mixed measures of the attitude construct. In their opinion, cognitive and affective dimensions of attitudes are two different constructs and should not be measured together. According to them, this is mainly because only cognition has a stronger influence on behaviour than affection. For this reason Yang and Yoo (2004, p.20) argued that the anomaly reported in Davis et al.'s findings could have been "because the potentially significant influence of cognition was offset by the insignificant influence of affect". Zhang, Aikman and Sun (2008) continued to investigate the nature of two types of attitudes—attitudes toward object (ATO) and attitudes toward behaviour (ATB). Their study showed that they are two distinct constructs and ATB fully mediates the role of ATO on the user's behavioural intention to use a system. In other words, positive attitude toward computer technologies will only indirectly lead teachers to decide to use such technologies in the learning environments. Zhang et al. (2008) also cautioned that the mismatched between conceptualisation and operationalisation of attitude in past studies may have caused researchers to overlook the importance of attitudes in technology acceptance studies.

Understandably, appreciating and monitoring teachers' computer attitudes is important in ensuring the success of computer integration in the classrooms. At the same time, understanding the antecedents of computer attitudes is equally important as it can lead to teachers forming more favourable attitudes toward computers. Thus, the next section will discuss the possible factors related to computer attitudes.

4. What affects computer attitudes?

It is important that student teachers at teacher training institutions receive adequate training to be able to integrate computer technologies effectively when they go back to schools as teachers. Teo (2008) warned that failure to do so will produce teachers who are ill-prepared to teach effectively with

computer technologies. For this reason, the preceding literature will not only focus on the antecedents of teachers' computer attitudes but that of student teachers' as well.

In general, it is believed that there are many antecedents of teachers' computer attitudes. Two widely studied antecedents are the teachers' perceptions of how useful and easy to use computers are. The relationships between these two antecedents and computer attitudes are deeply rooted in the TAM (Davis, 1989). The TAM posits that a user's attitudes toward computer use is jointly influenced by how the person perceived the usefulness of a system and its ease of use. Findings from past studies have suggested that student teachers' attitudes toward computer use are directly influenced by perceived usefulness and ease of use (Teo et al., 2007; Luan & Teo, 2009). Recent studies showed evidence that perceived usefulness and perceived ease of use have a direct effect and indirect effect on computer attitudes respectively among secondary school teachers (Moses, Wong, Mahmud & Abu Bakar, 2013; Wong, Osman, Goh & Rahmat, 2013). Suffice to say, when compared between the two factors, perceived usefulness is considered to be a stronger predictor on attitudes toward computer use than perceived ease of use (Teo, Lee & Chai, 2007; Luan & Teo, 2009). In essence, the aforesaid findings suggest that favourable computer attitudes is formed when both student teachers and teachers believed that computers are useful and easy to use.

Teo et al. (2008) also further suggested that apart from the two aforementioned factors, subjective norms can affect teachers' computer attitudes. Their findings indicate that teachers' computer attitudes are influenced by the views of people whom they regard as important in their lives. In other words, when teachers believe that important people such as school principals support their computer use, they tend to form more positive computer attitudes. Teo et al. (2008) proved that subjective norm does influence computer attitudes even when computer use in the classrooms is volitional and not mandatory.

In addition to perceived usefulness, perceived ease of use and subjective norms, Teo and Schaik (2009) found facilitating conditions to have a significant influence on computer attitude indirectly through perceived ease of use among student teachers. They defined facilitating conditions as factors that exist in the environment which a person believe have an influence over a his/her desire to perform a task (Teo & van Schaik, 2009) while Venkatesh, Morris, Davis and Davis (2003) explains it as the degree to which an individual believes that an organizational and technical infrastructure exists to support use of the system. In addition, technological complexity has been found to have a direct and significant impact on student teachers' computer attitudes (Teo, 2012). It is defined as the degree to which a person believes that a system is relatively difficult to understand and use (Thompson, Higgins, & Howell, 1991). This means that when student teachers perceived computers to be low in complexity, the likelihood of them possessing positive attitudes is higher.

In a more recent study, the results of a study by Wong (2013) pointed to the importance of learning strategies in fostering more favourable computer attitudes among student teachers. Learning strategies such as attitudes, motivation, time management, concentration, selecting main ideas, study aids and test strategies were most significantly correlated with attitudes toward computers. Out of these seven learning strategies, only selecting main ideas was found to be the best predictor of computer attitudes. It could then be concluded that student teachers with the ability to identify important points in lectures and pinpoint pertinent concepts in reading materials will have more positive computer attitudes (Wong, 2013).

The aforementioned studies provide some evidence that computer attitudes are influenced by many variables. It is, therefore, possible to manipulate these variables to form more positive computer attitudes among student teachers and teachers. At the same time, past literature have also shown that non-manipulatable variables such as teacher characteristics are equally capable of affecting computer attitudes. For example, gender has had a mediating effect on computer attitudes based on many studies in the past 20 years (Wong & Hanafi, 2007). Male student teachers were found to possess more significant positive attitudes towards computer laptops than female student teachers (Kay, 2006). The gender gap reduced when both males and females were given access to 24-hour access to a laptop and the Internet. On the contrary, the gender gap between male and female teachers were not apparent when teachers have equal access to computers (Bakr, 2011).

5. Conclusion

To return to the main question raised in this paper—Does attitudes matter for teacher education in developing countries?, it would be reasonable to assume that the answer is a definite yes. Echoing Shaft, Sharfman and Wu's (2004) point of view, Sadik (2006) stressed that computer attitudes is a very important variable to be studied in teacher education because computer attitudes when taken as an independent variable, it has the ability to predict teachers' computer use in the classrooms. On the other hand, as a dependent variable, it is affected by many manipulatable and non-manipulatable antecedents. In other words, computer attitudes has an effect on teachers' intention to use computers and at the same time, it can be changed and shaped to be more positive. Policy makers and curriculum planners must acknowledge the role computer attitudes plays in ensuring the success of computer integration in the classrooms. The author would like to stress that many of the aforesaid cited studies originated from the developed world, but strongly believes that studies undertaken in such countries are very relevant to developing countries despite the cultural diverse technology users. Clearly, developing countries are implementing education reform policies aimed at matching the technological advances of developed countries. In a nutshell, computer attitudes is too important to be missed, more so for teacher education in developing countries.

References

- Albirini, A. (2006). Teacher attitudes toward information and communication technologies: the case of Syrian EFL teachers, *Computers & Education*, 47(4), pp.373–398.
- Ajzen, I. (1988). *Attitudes, personality, and behavior*. Milton-Keynes, England: Open University Press & Chicago, IL: Dorsey Press.
- Ajzen, I., & Fishbein, M. (1977). Attitude-behavior relations: A theoretical analysis and review of empirical research. *Psychological Bulletin*, 84, 888-918.
- Ajzen, I., & Fishbein, M. (2005). The influence of attitudes on behavior. In D. Albarracín, B. T. Johnson, & M. P. Zanna (Eds.), *Handbook of attitudes and attitude change: Basic principles*. Mahwah, NJ: Erlbaum.
- Bakr, S. M. (2011). Attitudes of Egyptian teachers towards computers. *Contemporary Educational Technology*, 2(4), 308-318.
- Breckler, S.J. (1984). Empirical validation of affect, behavior, and cognition as distinct components of attitude, *Journal of Personality and Social Psychology*, 47, 1191- 1205.
- Davis, F. D. (1989). Perceived usefulness, perceives ease of use and user acceptance of IT. *MIS Quarterly* , 319-339.
- Davis, F. D., Bagozzi, R. P., & Warshaw, P. R. (1989). User acceptance of computer technology a comparison of two theoretical models. *Management Science*, 35(8), 928-1003.
- Divine, R.L., Wilson, J.H. & Daubek, H.G. (1997). Antecedents of student attitudes towards computers. *Journal of Marketing Education*, 19, 54-65.
- Fishbein, M and Ajzen, I. (1980). *Understanding attitudes and predicting social behaviour*. Prentice Hall: Englewood, Cliffs, New Jersey.
- Garland, K.J. & Noyes, J.M. (2008). Computer attitudes scale: How relevant today. *Computers in Human Behaviour*, 24(2008), 563-575.
- Heale, M. (2011). Its not about the technology, its about the student learning. Retrieved from <http://www.ssat-inet.net/en-gb/resources/Pages/olc/papers/itsnotaboutthetechnology,.aspx>
- Heinssen, R. K., Glass, C. R., & Knight, L. A. (1987). Assessing computer anxiety: Development and validation of the computer anxiety rating scale. *Computers in Human Behavior*, 3, 49–59.
- Igbaria, M. & Parasuraman, S. (1993). Attitudes toward microcomputers: development and construct validation of a measure. *International Journal of Man-Machine Studies*, 35, 553-573.
- Kay, R. H. (1993). A practical research tool for assessing ability to use computers: The computer ability survey (CAS). *Journal of Research on Computing in Education*, 26(1), 16-27.
- Luan, W.S. & Teo, T. (2009). Investigating the technology acceptance among student teachers in Malaysia: An application of the technology acceptance model (TAM). *Asia-Pacific Education Researcher*, 18(2), 261-272.
- Ma, W.W., Andersson, R. & Streith, K. (2005). Examining user acceptance of computer technology: An empirical study of student teachers. *Journal of Computer Assisted Learning*, 21(6), 387-395
- Moses, P., Wong, S.L., Bakar, K.A. & Mahmud, R. (2013). Perceived usefulness and perceived ease of use: Antecedents of attitude towards laptop use among science and mathematics teachers in Malaysia. *The Asia-Pacific Education Researcher*, 22(3), 293-299

- Ministry of Education Malaysia (2012). Preliminary Report: Malaysia Education Blueprint 2013-2025. Kuala Lumpur: Ministry of Education.
- Nistor, N. & Heymann, J. O. (2010), Reconsidering the role of attitude in the TAM: An answer to Teo (2009a). *British Journal of Educational Technology*, 41, E142–E145.
- Peeraer, J. & Van Petegam, P. (2011). ICT in teacher education in an emerging developing country: Vietnam's baseline situation at the start of 'The Year of ICT'. *Computers & Education*, 56, 974-982.
- Roussos, P. (2007). The Greek computer attitudes scale: construction and assessment of psychometric properties. *Computers in Human Behavior*, 23, 578–590
- Rosenberg, M. J., & Hovland, C. I. 1960. Cognitive, affective, and behavioral components of attitudes. In C. I. Hovland & M. J. Rosenberg (Eds.), *Attitude organization and change*. New Haven: Yale University Press.
- Sadik, A. (2006). Factors influencing teachers' attitudes toward personal use and school use of computers new evidence from a developing nation. *Education Review*, 30(1), 86-113.
- Salzer M. S. & Burks V. (2003). A mediational study of computer attitudes, experience, and training interests among people with severe mental illnesses. *Computers in Human Behavior*, 19, 511–521.
- Smith, B., Caputi, P. & Rawstorne, P., 2000. Differentiating computer experience and attitudes toward computers: An empirical investigation. *Computers in Human Behavior*, 16, 59–81.
- Shaft, T., Sharfman, M. & Wu, W. (2004). Reliability assessment of the attitude towards computers instrument (ATCI). *Computers in Human Behavior*, 20(5), 661-89.
- Southeast Asian Ministers of Education Organization (2010). Report of the Status of ICT integration in Education in South East Asian countries. Retrieved from http://www.icde.org/filestore/Resources/Reports/SEAMEO_ICT-Integration-Education2010.pdf
- Teo, T. (2012). Modelling the influences of beliefs on preservice teachers' attitudes towards computer use. *European Journal of Educational Research*. 1(1). 13-22.
- Teo, T. (2012): Examining the intention to use technology among pre-service teachers: An integration of the Technology Acceptance Model and Theory of Planned Behavior, *Interactive Learning Environments*, 20(1), 3-18.
- Teo, T. (2009). Is there an attitude problem? Reconsidering the role of attitude in the TAM. *British Journal of Educational Technology*, 40, 1139–1141.
- Teo, T., Lee, C. B. & Chai, C. S. (2008). Understanding pre-service teachers' computer attitude: Applying and extending the Technology Acceptance Model (TAM). *Journal of Computer Assisted Learning*, 24(2), 128-143.
- Teo, T. (2008). Pre-service teachers' attitudes towards computer use: A Singapore survey. *Australian Journal of Educational Technology*, 24(4), 413-424.
- Teo, T., Lee, C. B. & Chai, C. S. (2008). Understanding pre-service teachers' computer attitudes: Applying and extending the Technology Acceptance Model (TAM). *Journal of Computer Assisted Learning*, 24(2), 128-143.
- Teo, T., & Schaik, P. van (2009). Understanding technology acceptance among pre-service teachers: A structural-equation modeling approach. *The Asia-Pacific Education Researcher*, 18(1), 47-66.
- Thompson, R. L., Higgins, C.A., & Howell, J.M. (1991). Personal computing: Toward a conceptual model of utilization, *MIS Quarterly*, 15(1), 125-143.
- Yang, H.-d. & Yoo, Y. (2004). It's all about attitude: Revisiting the technology acceptance model. *Decision Support Systems*, 38(1), 19-31.
- Yuen, H.K. & Ma, W.K. (2002). Gender differences in teacher computer acceptance. *Journal of Technology and Teacher Education*, 10(3), 365-382.
- Venkatesh, V., Morris, M.G., Davis, F.D. & Davis, G.B (2003). User acceptance of Information Technology: Toward a unified view, *MIS Quarterly*, 27, 425-478.
- Wong, S. L., & Hanafi, A. (2007). Gender differences in attitudes towards Information Technology among Malaysian student teachers: A case study at Universiti Putra Malaysia. *Educational Technology & Society*, 10(2), 158-169.
- Wong, S.L., Jalil, H.A., Ayub, A.F.M. & Tang, S.H. (2003). Teaching a discrete Information Technology course in a constructivist learning environment: Is it effective for Malaysian pre-service teachers? *The Internet and Higher Education*, 6(2), 193-204.
- Wong, K.T., Osman, R., Goh, P.S.C. & Rahmat, M.K. (2013). Understanding student teachers' behavioural intention to use technology: Technology acceptance model (TAM) validation and testing. *International Journal of Instruction*, 6(1), 89-104.
- Wong, S.L. (2013). Assessing the relationship between student teachers' computer attitudes and learning strategies in a developing country, *International Journal Quantitative Research in Education*, 1(1), 3–19.
- Zhang, P., Aikman, S. N., & Sun, H. (2008). Two types of attitudes in ICT acceptance and use. *International Journal of Human-Computer Interaction*, 24(7), 628-648.
- Zhang, P., & Sun, H. (2009). The complexity of different types of attitudes in initial and continued ICT use. *Journal of the American Society for Information Science*, 60(10), 2048-2063.

Construction of Web Communication System to Support Young Teachers' Training

Takeshi MORISHITA^{a*}, Hiroo TSUKAMOTO^b, Toshiro KIKUNAGA^c,
Takashi SAKODA^a, Ikufumi WAKISAKA^a & Satoshi TSUCHIDA^a

^a*Faculty of Education, Kagoshima University, Japan*

^b*Kagoshima Prefectural Institute for Education Research, Japan*

^c*Kagoshima Daimyougaoka Elementary School, Japan*

*morishita@edu.kagoshima-u.ac.jp

Abstract: There numerous small-scale public schools, including on remote islands and in other locations, in Kagoshima, Japan. Therefore, we suggest a method of mentoring between young teachers via the Internet because it is difficult for persons to meet in many of these areas. We added three functions to the existing portfolio system and constructed a web communication system that young elementary and junior high school teachers can use for support and to share ideas with each other on the Internet. The teachers used two systems, the comment column and the bulletin board, for different purposes. However, there was considerable variation in the use of the system. Moreover, to improve the use situation, we found that it was necessary to make the system compatible with a mobile phone, making it possible to exchange opinions, and study the applicable scope of communication on the Internet.

Keywords: Communication, Internet, system development, young teachers' training

1. Introduction

1.1 Background

It is necessary to improve the qualifications and the quality of teachers generally in Japan. It has been suggested that there should be a plan for helping a teacher continue to develop throughout the entirety of her/his professional life as part of the second basic plan for the promotion of education by the Ministry of Education, Culture, Sports, Science and Technology (MEXT), 2013. It has been suggested that on-the-job training should be structured through cooperation and collaboration among metropolitan and district boards of education as well as universities because this approach can lead to greater enhancement and advancement of on-the-job training, including young teachers' training.

We have constructed an "assessment system to visualize a teacher's formative process and achievement" and attempted to unify "teacher training and training function through the graduate's follow-up survey." This is because we must respond to social needs which are training of teachers in advanced practical skills and conforming to the image of the teacher in society, among students, graduates, and faculty members. In a study on the "construction and use of the education system which contribute to the formation of the professional ability of the teacher" 2010–2012, we discussed the skills required for a teacher, which consisted of nineteen items in five categories, and developed a system to show a teacher's ability visually and an assessment that aims at enhancing and deepening teaching skills of students in a teacher training course that is recorded in a portfolio. This approach is based on a portfolio, the purpose of which is to support a teacher after graduation, and which is used as a tool to help young teachers understand how they can develop professional abilities and to support their reflection (Faculty of Education, Kagoshima University, 2013).

However, there are many small-scale public schools, including on remote islands and in other locations in Kagoshima, where it is difficult for teachers to obtain such support: it is 43.4% of all elementary schools; it is 40.6% of all junior high schools. The national average is 19.5 teachers per school in elementary schools and 23.7 teachers per school in junior high schools, but in Kagoshima there are a relatively small number of teachers per school: 13.1 teachers per school in elementary

schools and 17.8 teachers per school in junior high schools (MEXT, 2012). Recently, schools have conducted collaborative meetings, but there has been little discussion related to communication between co-workers who are young and inexperienced and their seniors. Therefore, it is difficult for teachers to discuss difficulties they face in teaching and to support each other.

1.2 Purpose of This Study

To address the above issue, we constructed a web communication system for young elementary and junior high school teachers using an existing portfolio system in cooperation with the board of education in Kagoshima. The system enhances mentoring by enabling young, senior, and similar young teachers, who are not mentors, to form a relationship (Rhodes, Stokes, & Hampton, 2004). There is a case in which a mid-level leader and a similar age group as well as an instructor mentored young teachers during their training in Japan (Shimada, 2012). However, it is difficult for teachers to meet in many areas on remote islands and other locations. Therefore, we suggest mentoring between young and similar young teachers through the Internet.

Therefore, the purpose of this study is to extend the functions of the existing portfolio system and construct a web communication system that young elementary and junior high school teachers can use to support each other and share ideas on the Internet.

2. Extension of Functions for the Existing System

The existing system is a self-support web tool that a teacher may use to evaluate her/his self-growth and reflect on whether s/he has to improve certain abilities to improve her/his teaching skills. Each teacher has a user ID, a password, and a portfolio. S/he makes a record by the next flow every year.

- i. S/he records goals (skills, abilities) for the year in April.
- ii. S/he makes a record of her/his teaching (such as school affairs, workshops, and lessons).
- iii. S/he evaluates her/his skills as a teacher and reflects on the year in March.
- iv. S/he submits topics for consultation in the comment column as needed. A university instructor confirms and replies to the topics in the comment column, and in this way the teacher can receive advice from an experienced university instructor.

The existing system was tailored to an individual, but we thought that it might be reworked to promote communication between young teachers by providing materials for sharing information and exchanging opinions. In particular, the following utilization and effects are expected.

- Young teachers utilize a web communication system to conduct a thorough investigation of each training problem through collaborating and exchanging information with each other.
- Young teachers who have similar professional teaching experience and are work at neighboring locations can discuss and perform mentoring on the Internet by sharing daily training problems and studying the problems together for a year.
- When they meet face to face, teachers can plan solutions to problems immediately because they have communicated about and shared topics through the Internet on a continuing basis.
- Teachers are able to receive a variety of advice and support from inspectors or school managers by becoming a member of the web communication system.

To realize the system described above, it must be possible for teachers to communicate through text, voice, and movies in a developed system. Therefore, through the extensions of function in this study, we implement communication functions based on the existing system to allow teachers to give advice and exchange opinions on the Internet.

2.1 Submitting Comments between Teachers

The existing system focused on a teacher's self-evaluation of her/his skills, and did not have a function for the viewing of other teachers' portfolios. Thus, it was difficult for a teacher to obtain advice and exchange opinions with other teachers by using the portfolio. Therefore, we implemented a comment submitting function for use between teachers. Moreover, we made it possible for a teacher, a school manager, an inspector, and a university instructor to view a portfolio, give advice, as well as exchange

opinions mutually. However, only the members who have access privileges to the portfolio through the access control, described below, can view and submit comments to the portfolio.

In particular, when a teacher submits a comment, “comment content,” a “contributor name,” and a “submission date and time,” these are shown in the comment column of her/his portfolio. At the same time, the other teachers are notified of the comment through e-mail, that they can access the portfolio. Thus, we hope to reduce the work involved in the teacher’s checking her/his portfolio frequently.

2.2 Access Control

The existing system is a self-support web tool that a teacher can use to evaluate her/his own growth. We can imagine that there might be teachers who do not wish for anyone to view their portfolio easily. However, there might be teachers who would like to receive instructions and advice based on their portfolios from an authorized inspector or university instructor to achieve their goals during the year.

Therefore, we devised the system so that the teacher who is the owner of the portfolio can control the access privileges for her/his portfolio every year (Figure 1). For example, when s/he had a problem in 2013 with “student instruction,” s/he could show the portfolio to other teachers who had the same problem, her/his own school manager, a university instructor, and an inspector who specializes in student instruction, and discuss her/his accomplishments and solution to the problem by receiving advice and exchanging opinions with the other individuals. In the setting window, a box is divided into two columns, and user names are listed according to access or no access. In other words, all the user names whose portfolios cannot be accessed are listed in the right-hand column, and the user names whose portfolios can be accessed are in the left-hand column. The user names in each box can be moved by using the “Add” or “Cancel” button.

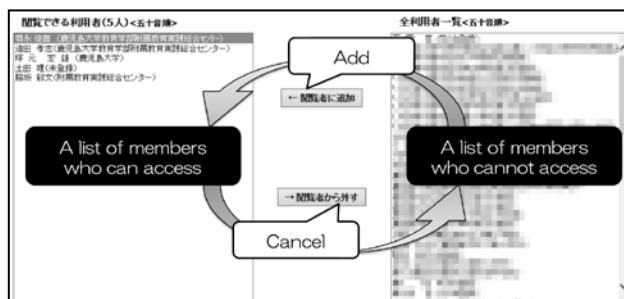

Figure 1. Access control screen

2.3 Submission Classification Select in Bulletin Board

The comment column for each portfolio is intended mainly for one-to-one communication between teachers. However, in this study, we aim at facilitating mentoring by a number of teachers. It is therefore necessary to establish a virtual space for discussion in which a number of teachers can give advice and not just discuss one-to-one. When teachers talk about problems based on a text, it is necessary for a viewer to understand easily “what kind of answer a consultant finds.”

Therefore, we implemented a bulletin board system and a function by which a contributor can select what kind of answer s/he is looking for at the time of a submission (Figure 2). For example, we made it possible to choose from a selection of answers that are prepared beforehand, such as the contributor needs “counseling,” “a document,” “a practice example,” “advice,” “a tweet,” and “others.” In this way, we expect that both the sides—the viewer and the contributor—can discuss and respond smoothly.

In this bulletin board system, we implemented a function for attaching a file. The kinds of files that the teachers can attach are a Microsoft Office file, a PDF (Portable Document Format), a picture, and movies. Since teachers can attach pictures and movies, they can share, for example, part of their actual class, a review class, or a discussion between teachers. However, the upper limit of the file size that can be attached is 20MB because the disk space of the server is limited.

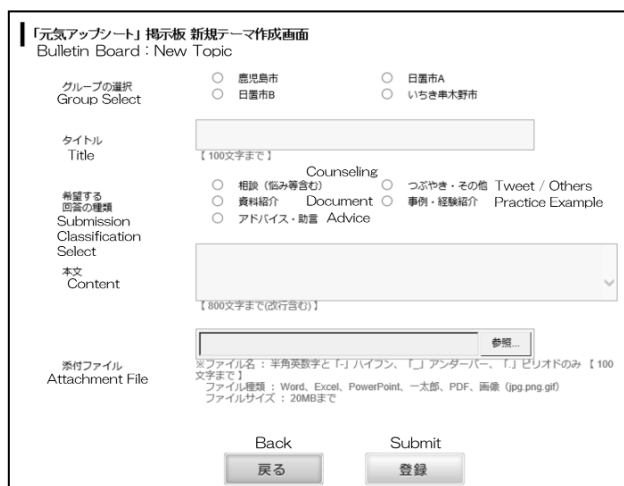

Figure 2. New submission on bulletin board

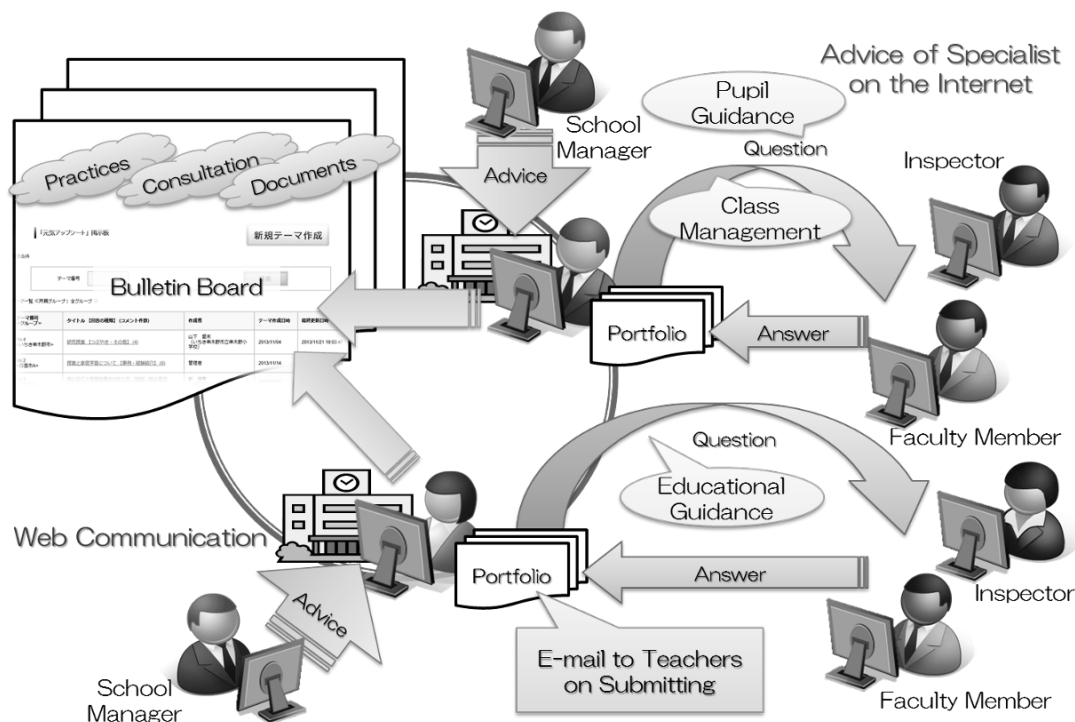

Figure 3. Utilization example of comment column and bulletin board in web communication system

3. Evaluation

3.1 Research Method

This web communication system, which included the extensions discussed in the previous chapter, was implemented at August 2013 (Figure 3). We undertook a questionnaire survey for 17 teachers to evaluate this system in December. The survey items were as follows, and teachers used free description:

- Q1. Did you use the web communication system after September? Why?
- Q2. When did you use the bulletin board? When did you like to use it?
- Q3. When did you use the comment column? When did you like to use it?
- Q4. What do you think of the positive and negative aspects of exchanging opinions between teachers through the web communication system?
- Q5. Do you have any question about the use of the web communication system?

3.2 Result

3.2.1 Utilization Situation

Six teachers answered “Yes” in Q1. In addition, two teachers answered “a little” instead of answering “Yes.” The reasons for responding “Yes” included “I thanked for teachers to visit my lesson,” “I could receive advices.” The reasons for answering “No” included “work and events were given priority,” “I did not feel the need to use it because I asked for advice directly from the same school teacher.”

3.2.2 Method for Utilization of Bulletin Board

There are frequent answers about ideas for lessons and class management in Q2, for example, “I asked about an idea for planning a class,” “I got advice when I prepared a teaching plan,” “I wanted to ask the opinions of teachers in other areas or at other schools when I planned class management and lessons,” “I got information about class management and learning instructions.” In addition, we found that teachers were positive about the possibility of using the bulletin board, for example, “I would like to use it as an

opportunity to cooperate actively between elementary schools and junior high schools,” “I would like to watch open classes and exchange opinions between teachers.”

However, unlike with the comment column, the bulletin board is not a system whereby a notice reaches other members when a member submits a message on the board. Therefore, it is a problem with the system that teachers cannot receive a response in a short amount of time when they would like to obtain advice. For example, we received the response “I would like to get a reply as soon as possible when I’m in trouble.” In addition, we found that teachers were anxious about submitting a comment on the Internet to teachers whom they did not know well, for example, “I was afraid that it was only a text how it would be received by others.”

3.2.3 Method for Utilization of Comment Column between Teachers

The teachers expressed that they would like to use the comment column when receiving professional support from university instructors and inspectors, in Q3. In addition, there was also a view expressed that teachers would like to use the system to contact each other, for example, “I suggest an answer for myself about a problem and receive praise for it from other teachers,” “I would like to use it for exchanging small amounts of information in the future.” However, the system is currently not used well in comparison with the above-mentioned bulletin board system because about half of the teachers answered that they “did not use” it.

3.2.4 Effect of Exchanging Opinions on the Internet

Teachers responded with a variety of opinions on both positive and negative aspects in Q4. A positive aspect is that a teacher can use the system to ask the opinion of others when there is not a partner physically present nearby, and moreover, there is no limit on the time and place, for example, “Even if members could not gather physically, I could submit the comment anytime,” “I could exchange opinions willingly, and there is little limitation on the time.” In addition, teachers can ask for a variety of opinions throughout the school because it is easy to share a topic on the Internet, for example, “I could get a variety of thoughts on one theme,” “I could ask others’ opinion on various viewpoints.”

However, a negative aspect is that it is not easy to have a connection and exchange opinions directly with a virtual connection on the Internet, for example, “It is difficult to ask teachers whom I have met only several times,” “I did not feel a need because it is best to ask teachers from the same school.” In addition, some teachers expressed the view that they would not be interested in using it because it requires work to maintain the system and the computer, for example, “I cannot readily become accustomed to connecting to the system because the computers that have the Internet are found only at the school,” “It is not simple to access the system, [it] needs to have a password input because it is too busy.” Therefore, there is a need for an input terminal, for example, “It is better to access it with a mobile phone,” and it is suggested that there is a need to develop an environment in which many members can frequently participate.

3.2.5 Unclear Points about Method for Utilization

There were a few teachers, as seen in Q5, who felt that the method for utilizing the system was unclear. However, we thought that it was necessary to promote regular use because the teachers answered, “I forgot how to use it when I used it again after a long absence.” In addition, the teachers answered, “The e-mail notification does not come to a mobile phone.” This is because the system may reject a computer domain e-mail due to restrictions by the Japanese wireless provider that may send unwanted e-mails to spam. Thus, it is necessary to alter the receive setting of the mobile phone for each individual contract so that the teacher is able to receive e-mail from the mail server that posts a notice.

3.3 Consideration

Concerning the users of the system, we can classify them broadly into the teachers who use it frequently and the teachers who do not use it at all. The teachers who use it frequently collected and submitted classroom newsletters, practices related to class management, ideas for lessons, writings on the

blackboard, and other activities along with the bulletin board system. However, the submission frequency for the comment column was less than for the bulletin board system, but the teachers used it often to contact each other and thank others in the comment column. Thus, we suggest that teachers should use the bulletin board system for collecting and submitting the information that they would like to save for a relatively a long time and use the comment column for short messages. The teachers should definitely be tactful about the use of the two different systems.

A problem to be dealt with in the future is how to improve the use situation. As one of the solutions, it is necessary to study the issues below:

- using it with a mobile phone, in response to the opinion “I would like to access the system with a mobile phone.”
- making a clear requisite, scale and inevitability for exchanging opinions on the Internet.
- studying the applicable scope of communication on the Internet in response to the opinion “It is good to make the consultation system on the Internet in case there is only one subject-based teacher in a junior high school or there are few training opportunities on a remote island..”

4. Conclusion

The purpose of this study was to extend the functions of the existing portfolio system and construct a web communication system that young elementary and junior high school teachers can use to support each other and share ideas on the Internet. We developed and added a function for submitting comments, an access control function, and a function for submitting selected classifications to the existing portfolio system, and implemented it. The results of the survey for the teachers showed that they used the two systems, the comment column, and the bulletin board, for different purposes. However, there was considerable variation in the use situation of the system. Moreover, to improve the use situation, we found that we have enable it to be used with a mobile phone, make it necessary to have exchange of opinions, and study the applicable scope of communication on the Internet.

In addition, we set up the system to send a notification e-mail when teachers submitted topics to the bulletin board after this survey, since it required a lot of effort for teachers to check whether a new topic was submitted, and they hoped that they would receive a notification e-mail from the system when a teacher submitted a new topic to the bulletin board. We hope that this will enable the use situation to be improved in the next year.

Acknowledgements and Additional Statement

We would like to thank all the teachers in Kagoshima city, Hioki city, and Ichikikushikino city who collaborated on this research. This study was supported by the teacher training model curriculum project of the National Center for Teachers’ Development in Japan. In addition, part of the system discussed in this paper was addressed in a paper by Morishita *et al.* (2013). In addition, this system was studied when Prof. Kikunaga and Associate Prof. Tsukamoto were at Kagoshima University in 2013.

References

- Faculty of Education, Kagoshima University (2013). *Construction and Operation of Educational System to Build Teacher's Capacity: Final Report 2012*. Kagoshima, Japan: Art Press. (in Japanese)
- Morishita, T., Tsukamoto, H., Kikunaga, T., Sakoda, T., Wakisaka, I. and Tsuchida, S. (2013) Development of Communication Support Modules for Teachers. *Proceedings of the 38th Annual Conference of Japanese Society for Information and Systems in Education* (pp. 93–94), Kanazawa, Japan. (in Japanese)
- Rhodes, C., Stokes, M., and Hampton, G. (2004) *A Practical Guide to Mentoring, Coaching and Peer-Networking*. Routledge, London and NY.
- Shimada, N. (2012). *Mentoring Handbook for Middle Leader: Toward Enhancing of Young Teacher's Support*. Panasonic Education Foundation, Tokyo. (in Japanese)
- The Ministry of Education, Culture, Sports, Science and Technology (2012). *School Basic Survey 2012*. http://www.mext.go.jp/b_menu/toukei/chousa01/kihon/kekka/k_detail/1329235.htm (in Japanese)

Detailed User Relation Visualization on Moodle

Ping LI & Siu Cheung KONG

*Department of Mathematics and Information Technology
The Hong Kong Institute of Education, Hong Kong
{pli, sckong}@ied.edu.hk*

Abstract: To enhance the learners' performance and learning efficiency on e-learning platform is an essential issue in current teaching and learning engagement. This paper applies IT techniques and analysis methods to visualize the learners' user relationship on the discussion board of Moodle based on the replying order and times they made in the selected topics/forum in a Moodle course, which will be very useful in the future for embedding the visualization into large-scale systems and further development of related applications. We mainly first extract the inner relation of users' participation in one/several selected discussion topics or a whole forum of a certain course. Then we visualize the user participation relation using Scalable Vector Graphics (SVG) provided by D3.js with aesthetic graph visualization. Our visualization with directed graph (digraph) structures provides easy understanding of users' network connections in topics/forum, and the weights of the connections indicating the replying times are shown both numerically on edges and visually by the thickness of edges. Digraph is applied here to indicate different replying order. We propose to perform visualization construction and representation via PHP with latest advanced programming libraries of jQuery and D3.js, while easy control of tree-structured menu for user relation visualization is realized by jsTree. In the experiments, our method consistently demonstrates high-quality detailed visualization of users' underlying relation structure they belong to, which may benefit the further study of improving the learning efficiency on e-learning platform.

Keywords: User relation analysis, graph visualization, directed graph, Moodle platform

1. Introduction

The trend of teaching and learning in digital classrooms with the help of social network platforms (SNPs) and learning management systems (LMSs) requires the teacher to transform from traditional pedagogical practices to advanced and creative ones. Although it is the fact that more and more accessible learning data are produced and available in the e-learning systems during the teaching and learning periods, yet there are so many data generated throughout the formal and informal learning process. Hence it becomes much harder for teachers to understand the students' performance within and after the teaching periods. To enhance the teaching and learning effects, students are encouraged to utilize the discussion forums embedded in the e-learning platforms (e.g. Moodle) for sharing ideas and helping each other in learning, which, in one aspect, helps to improve the teaching quality of the teachers, however, in another aspect, makes the user relation of the students in a course becomes more and more complicated. If such problems cannot be solved and the user relation information cannot be well extracted to inform the teachers to understand the students' interactions in the discussion forums of the e-learning platforms, the teaching quality online may decrease and the teachers may fail to understand the students' performance and guide the students' learning directions.

To enhance the learners' performance and learning efficiency on e-learning platforms and promote academic/teaching performance accordingly are essential issues in current teaching and learning engagement on e-learning platforms like Moodle. This paper aims at applying advanced IT techniques and analysis methods to study the learners' user relationship on the discussion board of Moodle based on the comments, replying order and times they made in the discussion, hence the information extracted will become useful materials for future analysis of learners' behavior online and even for providing suggestions to teachers as references for improving teaching quality in accordance to the needs of certain discussion topics and courses. The inner reason why we want to discover the user relation of a course or a topic online is that it will offer us better understanding of the key

interactions of the discussion for finding out related actions for steer the direction of the discussion while discussing. Again, visualizing the user relation also can let the teachers know the activeness and participation of the students during and after the discussion, hence the teachers can guide and help the students with special needs better in the e-learning process (Participation Map, 2013; Forum Graph, 2014). Through visualizing discussing topics with replying order and other related information such as replying times in discussion, it is possible to discover the underlying inner relation of users on related topics discussion or a course forum for learning enhancement purpose. In this paper, we apply hypertext preprocessor PHP with advanced programming libraries including jQuery, jsTree and D3.js to realize our detailed user relation visualization in the Moodle discussion forum.

2. Background of Study

Recently, researches about online relationship detection, analysis and visualization are becoming more and more popular. Our paper is made possible by the inspiration of previous work. Method for self-assessment in online discussion and co-occurrence relation discovery between keywords and learners are presented to analyze the content-based contribution making (Mochizuki et al., 2005), discussion relation is visualized through a Bulletin Board System. In addition to face-to-face participation relation researches, user relation on social media-platforms are investigated (Yndigegn, 2010), social encounters are found and can be extended by including them into online social networks. A boosting-based learning approach is presented to find and determine participation relation (Esuli, Marcheggiani, & Sebastiani, 2010), participation rather than selection of rich set features is preferred, and classification methods are utilized to decide correct assignment of relations. Given the observation of groups participated in similar tasks on online discussion community, participation relation frameworks are studied, and high online frequencies are found to be important to group relation cohesiveness (Chen, 2004). Framework that can be applied to scope eParticipation is proposed to study the participation areas and techniques online, and the framework enables better understanding of electronic participation (Tambouris, Liotas, Kaliviotis, & Tarabanis, 2007). In addition to participation user relation analysis, participation relation design is also studied. Engagement with dynamic relation design and applications provides new forms of participation online and offline (Hagen & Robertson, 2010). Platforms that allow social participation are investigated in (Kang et al., 2009), the relation between people and digital society are studied which will benefit participation platform architecture design based on user relation. Methods that can interactively and adequately model the relation in discussion forums based on social networks and dynamic information contents are required nowadays (Kim & Galstyan, 2010). Mainly, most methods currently focus on design and analysis of the relation of people on online platforms. However, the relations they process are mostly general-purpose relations of users in large-scale manner. There are very few methods specially designed to analyze the detailed user participation relation (user relation that keeps as much information as possible existed in the discussion) on certain topics and the whole forum on discussion board of e-learning platforms like Moodle, which is essential for enhancing reflective engagement of learners and promoting e-learning performance.

Recent advancement in online relation analysis provides ever-expanding possibility for studying the user participation relation on a discussion board. A discussion board is one type of social media, which is a good platform for investigating users' daily performance and interests. Users' performance on discussion forums are studied as reflection of their participation toward rich information world in (Shi, Zhu, Cai, & Zhang, 2009), different forum datasets are applied in their methods. In a cold-start problem, users only participate in some social relation, multi-relational factorization techniques are applied in (Krohn-Grimberghe, Drumond, Freudenthaler, & Schmidt-Thieme, 2012) for extracting the underlying unknown user relation out of the social relation. A new social relation is investigated (Yuan, Chen, & Zhao, 2011), and the relation is combined with friendship, thus heterogeneous relations are fused together providing efficient recommendation over the networks online, which can further facilitate online discussion participation relation analysis. The structure of community is related to the social context of users' activities online, a method is presented to detect community structure in social networks by analyzing time-based multi-relational datasets on discussion forums (Lin et al., 2011). As proposed long ago by Koll (1980), users' behavior and comments are applied as concept relation for information retrieval and analysis, and knowing the

user participation relation on e-learning discussion board will help a lot in enhancing future teaching and learning activities. Currently, there are actually a few learning analytics and forum visualization tools like SNAPP (Bakharia & Dawson, 2011; Dawson, Bakharia, & Heathcote, 2010), Participation Map (2013) and Forum Graph (2014) that can provide simple relation visualization of the Moodle discussion forums. However, these tools mainly focus on simple user connection relation visualization of the whole discussion forum only, and many useful aspects in addition to the connection are not kept well. To the best of our knowledge, there is no method specifically designed to visualize the detailed user relation with rich additional information for both one/several discussion topics and the whole forum. On the contrary, detailed user relation visualization for both discussion topics and forums provides deeper participation relation analysis of learners engaged, and will further make the teachers understand the interactions among learners better in order to let them have sufficient interactions in e-learning communication, and can steer the steps of the students' learning process.

3. Method

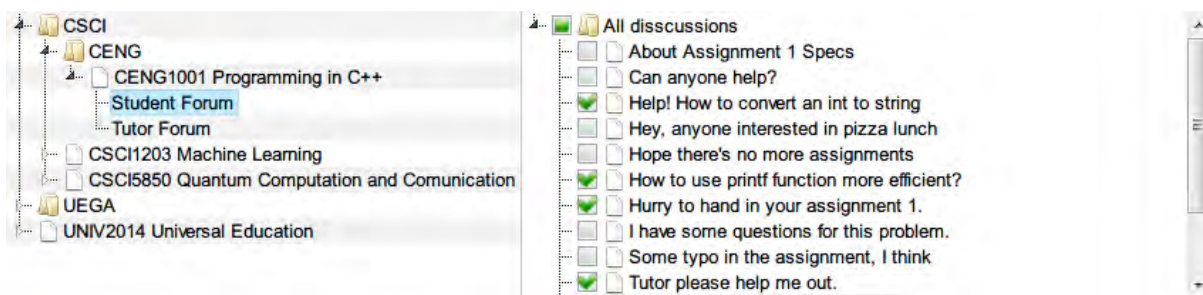

Figure 1. The tree-structured control menu of our user relation visualization in Moodle using jsTree.

In this paper, we utilize hypertext preprocessor PHP with latest advanced programming libraries including jQuery, jsTree and D3.js to realize our detailed user relation visualization for both one/several discussion topics and the whole discussion forum in Moodle with directed graph structure. Since Moodle is designed and implemented in PHP, we apply PHP as the main data-fetching programming language for the major framework design and realization of our user relation visualization tool/plugin for easy compatibility and high running speed purpose. We also apply the latest advanced programming libraries of jQuery, jsTree and D3.js to enhance the overall effects of our user relation visualization, which allow multi-browser performance. The library jQuery is applied here to provide lightened structure of simplified client-side implementation, which enhances the user experience and accelerates the speed of the user relation visualization through analysis of replying order and times within selected discussion topics and a whole discussion forum of a course in the database. The library jsTree is utilized for providing academic/teaching staff with easy interactive control of the user relation visualization system, and jsTree will create a cross-browser easy control tree-structured component as viewable menu for teachers' selection of interested topics/forum for user relation visualization. Figure 1 shows the tree-structured control menu of our user relation visualization in Moodle using the library jsTree. From Figure 1, we can see that the left side of our user relation visualization menu provides easily selection of Course Category, Course and Forum, and the right side of the control menu provides multiple topics selection within a Forum of a course, which enables easy control of user relation visualization for both one/several topics and a whole forum. The library D3.js (D3 for Data-Driven Documents) is applied here to provide our system with aesthetic scientific visualization of the user relation for display purpose using the Scalable Vector Graphics (SVG), which enables graphics scaling while preserving the shapes of the user relation vector image. And D3.js will apply the user relation data fetched to drive the creation and control of interactive user relation graphics in different web browsers providing us with aesthetic scientific display of user relation in directed graph visualization forms (See Figure 2). With all these advanced IT techniques embedded, we're able to discover the inner interactions of user participation in the

discussion forums, which can be further applied as guidance for directing user discussion activities on Moodle for enhancing students' e-learning effects.

4. Experimental Results

In our experiments, we have set up Moodle 2.6.1 using PHP 5.4.24, MySQL 5.5.32 and Apache 2.4.6 in a Microsoft Windows 7 64-bit system on a Intel Core i7 2.70GHz CPU PC with 8GB RAM for testing our detailed user relation graph visualization tool for discussion topics/forums. We invited volunteer students online for participating in the discussion of 14 forums within 6 testing courses in our Moodle platform. We have validated the correctness of the user relation visualization by comparing the visualization data with the user relation data in the database. Hence, we will only show the user relation visualization results of the discussion in the Student Forum of the testing course "CENG1001 Programming in C++" shown in Figure 1 as an illustration of the effectiveness of our detailed user relation visualization, and totally there are 10 users discussed in the Student Forum of this testing course.

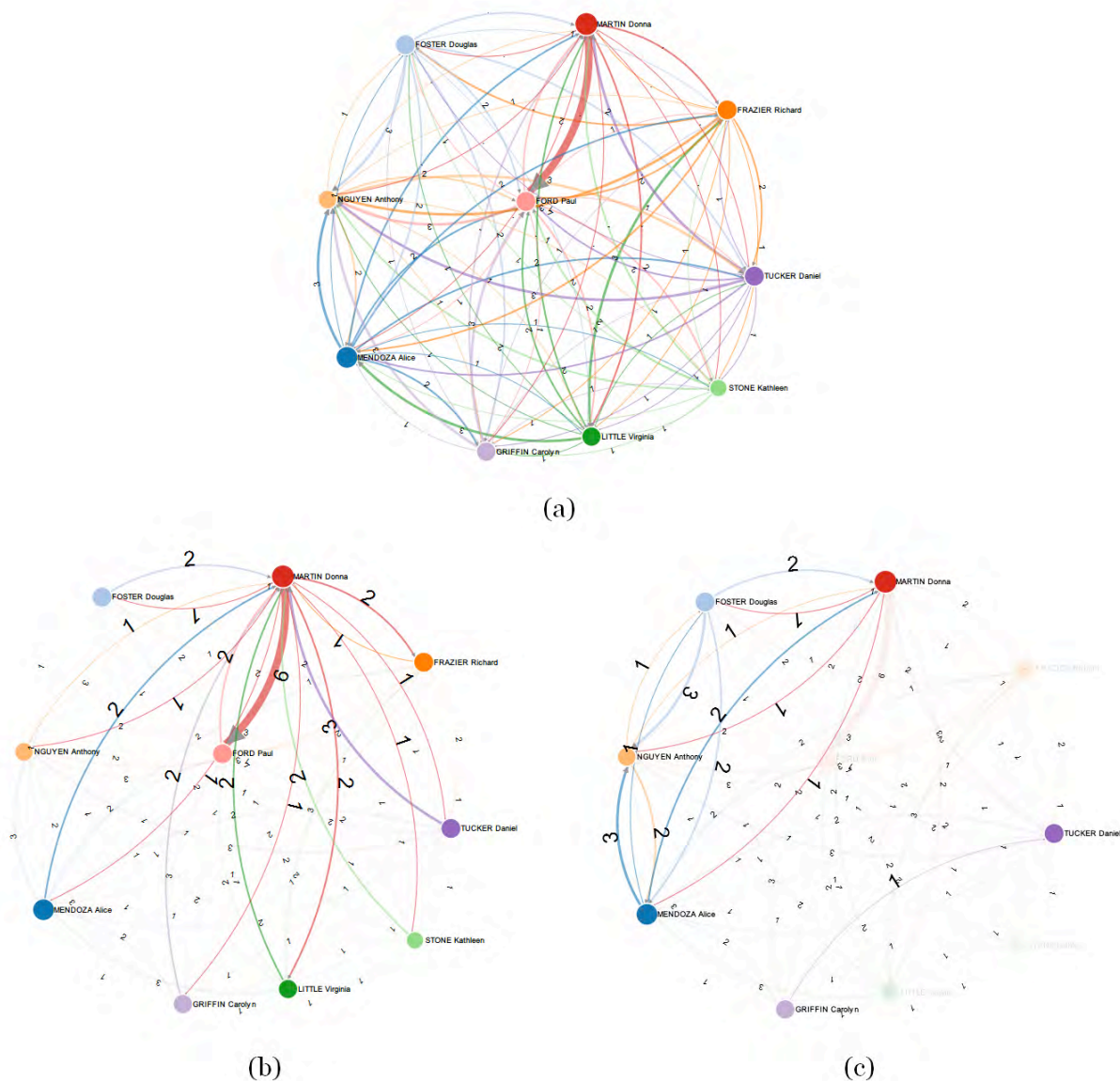

Figure 2. Graph visualization of our detailed user relation visualization. (a) Graph visualization of user relation for a whole forum, (b) graph visualization of a selected user and his/her relation with the other users in the forum, and (c) graph visualization of user relation for selected topics in Figure 1.

Figure 2 shows the graph visualization of our detailed user relation visualization method for the testing course “CENG1001 Programming in C++” shown in Figure 1. From Figure 2(a), we can see that the detailed underlying user relation of the discussion in the Student Forum of CENG1001 is explained well through graph visualization. We can see the 10 users participated in the Forum discussion and their detailed connections with each other. In our method, if A replied B, there will appear a directed edge from A to B in our visualization. Hence, with directed graph (digraph) visualization, we can keep and show more essential information in the discussion. There are numbers on the graph edges, which is the weights of the directed relation. If A replied B three times, there will appear a directed edge with the weight of 3 from A to B in the visualization. Therefore, actually we apply weighted digraph as the vehicle for our detailed graph visualization to keep more essential information. Figure 2(b) shows the case when applying mouse selection of a certain user, then all the users and connections that are related to the selected user in the Student Forum will be visualized by our method. This facilitates the easy viewing of specified relation for a certain user from complicated graph visualization for a whole forum. If there are a large amount of users in discussion, this will in addition enhance clear visualization of the user relation. Our approach provides the tree-structured menu for easy selection and browsing of user relation visualization for the user-interested topics within a forum. A practical application is that teacher may want to know the performance of students in certain discussion topics in e-learning. Figure 2(c) shows the graph visualization of user relation for selected topics in the Student Forum of CENG1001 shown in Figure 1. We can see from Figure 2(c) that there are generally two separated weighted digraphs in the visualization, which means there are groups of users discussed in the selected topics where inter-group discussion never happened. In summary, the graph visualization offers clear display of the network connections among academic/teaching staff and learners in the discussion using weighted digraph, where the weights of the graph edges are indicated with not only numbers on the edges but also proportional thickness of the directed graph edges. Thus, with our visualization, we can provide academic/teaching staff with advanced IT tool for detailed user relation visualization for discussion of certain topics or a whole forum in Moodle courses, which may be further applied to promote the learning efficiency and performance of learners on e-learning platforms.

5. Summary

Existing forum visualization methods and visualization functions provided in the learning analytics systems mostly deal with simple user relation visualization, and only visualization for the whole discussion forum is provided in the current system, which is obviously not enough for the purpose of analyzing the detailed user interactions and enhancing the learners’ efficiency and performance on e-learning platforms like Moodle for teaching and learning engagement. In this paper, we present to apply hypertext preprocessor PHP with latest advanced programming libraries of jQuery, jsTree and D3.js to realize our detailed user relation visualization for both one/several discussion topics and the whole discussion forum visualization in Moodle platform. Participation relation digraph visualization via Scalable Vector Graphics (SVG) by the library D3.js is provided in our approach. The visualization offers clear display of the network connections among academic/teaching staff and learners with weights, where the weights of the graph edges are indicated with both numbers on the edges and proportional thickness of the edges. Easy selection of target topics/forum for visualization is achieved via the latest light-weighted programming library of jsTree, where a tree-structured menu is provided for topic/forum selection to control the user relation visualization. The experiments have shown the high-quality scientific visualization of users’ underlying relation structure of our detailed user relation visualization based on their interactions among each other in the Moodle discussion forum. Our future work includes investigating different robust user relation analysis and visualization methods like graph theory, and extending the user relation visualization to more complicated social network structures with discussion content analysis. We will also apply our visualization in real course forum discussion study to promote and validate the usefulness of our method.

Acknowledgements

The authors would like to acknowledge the support of the project “Common Interests and User Relation Investigation on Moodle” of HKIED MIT small research grant (ref. MIT/SRG08/13-14).

References

- Bakharia, A. & Dawson, S. (2011). SNAPP: A bird’s-eye view of temporal participant interaction. *Proceedings of the International Conference on Learning Analytics and Knowledge*, 168-173.
- Chen, F. (2004). Passive forum behaviors (lurking): a community perspective. *Proceedings of the International Conference on Learning Sciences*, 128-135.
- Dawson, S., Bakharia, A., & Heathcote, E. (2010). SNAPP: Realising the affordances of real-time SNA within networked learning environments. *Proceedings of the International Conference on Networked Learning*, 125-133.
- Esuli, A., Marcheggiani, D., & Sebastiani, F. (2010). ISTI@SemEval-2 task #8: Boosting-based multiway relation classification. *Proceedings of the International Workshop on Semantic Evaluation*, 218-221.
- Forum Graph. (2014). *Reports: Forum Graph*. Retrieved May 26, 2014, from https://moodle.org/plugins/view.php?plugin=report_forumgraph
- Hagen, P., & Robertson, T. (2010). Social technologies: challenges and opportunities for participation. *Proceedings of the Biennial Participatory Design Conference*, 31-40.
- Kang, J.-M., Im, Y. S., Lee, K. Y., Lim, M. J., Lee, Y. D., Kang, E., ... Oh, S.J. (2009). A study for semantics participation platform architecture using RDF/OWL. *Proceedings of the International Conference on Hybrid Information Technology*, 512-515.
- Kim, J., & Galstyan, A. (2010). Towards modeling social and content dynamics in discussion forums. *Proceedings of the NAACL HLT Workshop on Computational Linguistics in a World of Social Media*, 13-14.
- Koll, M. B. (1980). Information retrieval theory and design based on a model of the user’s concept relations. *Proceedings of the Annual ACM Conference on Research and Development in Information Retrieval*, 77-93.
- Krohn-Grimberghe, A., Drumond, L., Freudenthaler, C., & Schmidt-Thieme, L. (2012). Multi-relational matrix factorization using Bayesian personalized ranking for social network data. *Proceedings of the ACM International Conference on Web Search and Data Mining*, 173-182.
- Lin, Y.-R., Sun, J., Sundaram, H., Kelliher, A., Castro, P., & Konuru, R. (2011). Community discovery via metagraph factorization. *ACM Transactions on Knowledge Discovery From Data*, 5(3), 17:1-17:44.
- Mochizuki, T., Kato, H., Yaegashi, K., Nagata, T., Nishimori, T., Hisamatsu, S., ... Suzuki, M. (2005). Promotion of self-assessment for learners in online discussion using the visualization software. *Proceedings of the Conference on Computer Support for Collaborative Learning*, 440-449.
- Participation Map. (2013). *Participation map version 1.5.1*. Retrieved May 26, 2014, from <http://www.participationmap.org>
- Shi, X., Zhu, J., Cai, R., & Zhang, L. (2009). User grouping behavior in online forums. *Proceedings of the ACM SIGKDD International Conference on Knowledge Discovery And Data Mining*, 777-786.
- Tambouris, E., Liotas, N., Kaliviotis, D., & Tarabanis, K. (2007). A framework for scoping eParticipation. *Proceedings of the Annual International Conference on Digital Government Research: Bridging Disciplines & Domains*, 288-289.
- Yndigegn, S. L. (2010). Extending design encounters with use of social media. *Proceedings of the Conference of The Computer-Human Interaction Special Interest Group of Australia on Computer-Human Interaction*, 356-359.
- Yuan, Q., Chen, L., & Zhao, S. (2011). Factorization vs. regularization: fusing heterogeneous social relationships in top-n recommendation. *Proceedings of the ACM Conference on Recommender Systems*, 245-252.

Development of Association Recommend Function for a Cross-curricular Subject Education Database as an Example in Disaster Prevention Education

Hiroyuki MURAMATSU^{a*}, Hideaki SHIMADA^a, Shingo KUMAGAYA^b & Satoshi TANAKA^a

^a*Faculty of Education, Shinshu University, Japan*

^b*First Element, Japan*

*muramatu@shinshu-u.ac.jp

Abstract: This study would like to suggest an association recommend function as a framework to compensate for the shortcomings of the search type method, by incorporating a recommend type information collection into the database, in order to effectively support teachers working on disaster prevention education. The similarity scores of individual contents in an item base were calculated, and a plug-in which displays the association mapping based on the calculation was developed. As a result of operation verification, the achieved recommend information targeted by the purposed association recommends function could be visually displayed.

Keywords: Recommend system, educational database, disaster prevention education

1. Introduction

Disaster prevention education in primary and secondary education has become an important issue, because in Japan natural disasters are often. Disaster prevention education in elementary and secondary education can be divided into extracurricular activities such as evacuation drills and disaster prevention lectures, and curricular activities such as research studies of disaster areas during social studies and the study of seismic mechanisms in science class. Current disaster prevention education is mainly handled individually, such as a single extracurricular event, or even within a subject itself. In disaster prevention education, it is necessary to consider the systematic-systematic teaching content (Sakurai, 2013). However, it is pointed out that practice of disaster education is difficult, because the disaster education includes a wide range of disciplines (Kishida et al, 2009).

Although class time is limited, measures can be suggested to enhance the effect of disaster prevention education, which will further gain importance in the future. For example, cross-curricular subject education can overcome the barrier between subjects and within/outside a subject, by promoting coordination between subjects or adding a new subject viewpoint in extracurricular activities. In addition to being time efficient, the contents can be taught from two or more viewpoints at the same time in a set time. This is considered to be connected to the establishment of knowledge by multifaceted connection, and the acquisition of “useful knowledge” which can promote the appropriate activities.

However, there are many obstacles in carrying out cross-curricular subject education. For example, while a junior high school science teacher may be able to explain the mechanism of a tsunami; this is difficult for teachers who do not teach science. Similarly, it is difficult for science teachers to teach subjects other than science. Elementary teachers can handle various subjects but each teacher has a different area of expertise outside the textbook. Under these conditions, a framework which can support teachers in the promotion of ideas leading to new application of cross-curricular subject education is needed.

For contents which are too large to browse personally, Ono, Asoh and Motomura (2011) classified the methods for a user to collect information into a search type or a recommend type. The search type is considered to be the conventional method used more frequently by teachers for class formation.

For example, Gijyutu.com (Gijyutu.com, 2014) gathers educational material for technical education, and various educational materials and practical ideas are stored as a database. Support from such an educational database can be seen in various areas. Not only on the Internet, but also various publications can be viewed as a type of database.

This kind of database is beneficial when designing a class, but most methods which use a database are premised by search type information collection by a teacher. However, search type information collection has the drawback of being a heavy burden for the teacher. This is also related to the problem that data in the database is not being utilized. Therefore, this study would like to suggest an association recommend function as a framework to compensate for the shortcomings of the search type method, by incorporating a recommend type information collection into the database, in order to effectively support teachers working on disaster prevention education.

According to Ono, Asoh and Motomura (2011), a recommend system should consist of a recommend engine which can predict the needs of a user and a user interface which displays the contents to the user. In this article, a specific recommend engine and user interface in the disaster prevention domain were experimentally created, and actual operations are reported.

2. Development

2.1 Specifications of “association mapping”

In the database which includes a mechanism to promote ideas leading to new practices as proposed by this article (hereinafter referred to as “this database”), the idea of an association search information display that expands an idea (hereinafter referred as “association”), as used in WebcatPlus (WebcatPlus, 2014), is thought to be more suitable than the generally used narrowing down search type. Clustering has also been used to display associated words in a concentric pattern according to distance from the search word in two dimensions. However, in many association systems, even though several association words are shown, which words should belong in different categories, as well as the strength or weakness of the words in relation to the search keywords, are not well reflected nor displayed in the same line. In this database, since various categories, such as school type and subject are thought to be set, visual information display (hereinafter referred as “association mapping”) in a concentric pattern as suggested by Akiguchi was adopted (Akiguchi, 2011).

Next, a method to consider how to recommend the contents (practical information and various resources) registered in this database was considered. Collaborative filtering is used to recommend the contents from many data sets. Collaborative filtering is largely divided between user based recommendations and item based recommendations. User based recommendations are suitable when the preferences of the user has original value, such as an EC production recommendation. Item based recommendations are judged only by similarity between items. In this database, item based recommendation is adopted since it is difficult to reflect user preference. To calculate similarity scores between items, the main body text, classification category, and tag of each content were targeted.

Various resources, such as practical information, educational material, thesis material, and survey material, exist in the targeted contents of this database. Furthermore, inclusion not only of text data, but also of images and movie data is expected. The database system itself must be able to flexibly process various data. Hence, use of CMS which is generally used to construct websites was decided and WordPress with a high world share was adopted.

WordPress is an open source CMS with high customizing flexibility and additional functions can be added as plug-ins. Plug-ins can be developed by PHP. Consequently, by using WordPress and developing the purposed associations recommend function as a plug-in, construction of a system with a higher degree of freedom was considered possible. A plug-in with a recommend function also exists in WordPress, but it only has a list type display.

From the above, we decided to achieve the purposed association recommend function as a plug-in for WordPress (hereinafter referred as “this plug-in”) by calculating the similar score of each content in the item base (hereinafter referred as article), and perform association mapping (hereinafter referred as “mapping”) based on the calculation.

2.2 Development of the Association Recommend Function

2.2.1 Calculation of Similar Score of Contents

This plug-in consists of three processes, namely 1) acquisition of related data from all articles, 2) setting of similarity weighting, 3) map creation and display.

For 1) acquisition of related data from all articles, the results of a morphological analysis for the text data of the main text body of the article, and the category and tag information set for the article, are acquired. An Internet service (Yahoo! Japan, 2014) which is provided as a Japanese language morphological analysis API, is used for morphological analysis of the text data in the text body of the article. The process is carried out in advance in order to increase the processing speed of the morphological analysis for all articles.

To carry out morphological analysis, three information items from the category and the tag of each article are abstracted from each article text in the WordPress database. Results of the morphological analysis are added to the database as meta information for each article.

In 2) setting of the similarity weighting, the system administrator can set the use rate of each information item when calculating the similarity score from the results of the morphological analysis and three information items of each article.

2.2.2 Preparation and Display Method of Association mapping

In 3) map creation and display, similar articles are plotted in two dimensions by the multi-dimensional scaling method, in order to present a map centered selection and display the article. First, the morphological analysis results of the entire article are acquired by repetition processing. Next, the posting ID of the selection and article display (which becomes the evaluation standard) is determined. Next, the Pearson’s correlation coefficient with other articles is calculated and the results stored. In that case, the calculated value is added by obtaining the weighting rate set in the basic settings, and set as the evaluation value.

By using the above evaluation values, and determining the distance between the article display and other articles by multi-dimensional scaling, a map which can respond to various display settings and display title length, can be drawn/displayed for the determined distance between the articles.

3. Implementation

3.1 Implementation

This plug-in was installed in a Linux, Apache 2.2.16, PHP 5.2.17 and MySQL5.5.1 environment. WordPress 3.8 was used for CMS. PHP and JavaScript were used to develop this plug-in. Moreover, Clickable CanvasjQuery (Wizard cord, 2014), a jQuery plug-in, was used for mouse event processing.

reports/news (14 kindergarten/preschool, 15 elementary, 15 junior high and 7 high schools) from each school category, 1 report, 27 research thesis. Some of these articles overlapped categories. For example, the study contents related to disaster prevention education in “Geographical Field of Junior High School Social Studies” can be cited. The text body of the article can be considered to be related to the goal of study guidance procedures and disaster prevention education. Study guidance procedures are the basis for consideration of the educational contents of each subject. More specifically, since this study focuses on cross-curricular subject education which overcomes the barrier between subjects and within/outside a subject, by setting the study guidance procedures as the base, contents of displayed information can be verified, which is thought to standardize confirmation of association recommend function operations. Mapping with the default settings is shown in Fig. 3. Rating results which become the basis for mapping is shown in Table 1. Articles are sorted in the order of correlation strength with the source article. The category includes formal information of each article like kinds of school, grades, subjects, etc. The tag includes additional keywords of each article.

From the rating results, information beyond social studies and geography was displayed, such as a comparison of the contents of new and old studies in other subjects, including domestic science, and nursery implementation was displayed as related information. A total of 12 articles were tagged as study guidance procedures, but according the article text body and the category similarity, tagged information beyond study guidance procedures could also be displayed. From these results, we determined that the purposed association recommends function was achieved.

Table 1: Result of a rating

Rank	Article Summary	Category	Tag	Correlation
—	(Source) Learning content of disaster prevention education in junior high school social studies geographical area "	Junior high school, Social studies	Course of study, Social studies	—
1	Comparison of old and new disaster prevention education in the "junior high school technology and home economics home	Junior high school, Home economics	Course of study, Home economic	0.98
2	Learning content related to disaster prevention education in the "High School Science"	High school, Science	Course of study, Science	0.97
3	Learning content new and old comparison of disaster prevention education in the "high school base fo home economic"	High school, Home economics	Course of study, Home economic	0.97
4	Prototype of disaster prevention education for children picture book that targets the historical earthquake of Akita Prefecture	Nursery, Practice	Picture book, Earthquake	0.97
5	Realities and challenges of creating a disaster manual and disaster prevention education and training programs of infant children with disabilities	Junior high school, Practice	Disabilities, Infant	0.96
6	Attempt of Disaster Education in Home Economics Clothing area	Junior high school, Practice	Home economics, Clothing	0.96

4. Conclusion

The purpose of this study was to develop an association recommend function as a mechanism to support teachers working in disaster prevention education. The similarity scores of individual contents in an item base targeting WordPress were calculated, and a plug-in which displays the association mapping based on the calculation was developed. As a result of operation verification, the achieved recommend information targeted by the purposed association recommends function could be visually displayed. In the future, we plan to increase the contents and carry out an evaluation test for teachers in greater detail. In addition, we plan to continue to consider the possibility of user-based recommendation function.

Acknowledgements

This study was carried out under a grant from the JSPS science research fund 25285244 (Research supervisor Satoshi Tanaka).

References

- Akiguchi, S. (2011) Development of Association Search System Using Fuzzy Clustering. *The 27th Fuzzy System Symposium*, 1147-1152. (in Japanese)
- Gijyutu.com (2014). Gijyutu.com. <http://gijyutu.com/main/> (accessed 2014.03.26)
- Kishida, S., Ohara, M. & Meguro K.(2009) A basic study on development of an education curriculum for disaster reduction in a compulsory education course, *Production research*, Institute of Industrial Science, University of Tokyo,713-716. (in Japanese)
- Ono, T., Asoh,H., & Motomura,Y. (2011) Technologies and Research Issues for Recommendation. *The Journal of Institute of Electronics, Information and Communication Engineers*, 94(4), 310-315. (in Japanese)
- Sakurai, A.(2013) A Preliminary Study on Disaster Education in Japan, *Journal of International Cooperation* 20(2/3), 147-169. (in Japanese)
- Segaran, T. (2008) Hatayama,T. & Kamozaawa,M. (Translation) : Programming Collective Intelligence. Tim Oirari,53-57. (in Japanese)
- WebcatPlus (2014) WebcatPlus. <http://webcatplus.nii.ac.jp/> (accessed 2014.03.25) (in Japanese)
- Wizard code (2014) "jQuery plug-ins that clickable graphic of HTML5 Canvas" <http://wiz-code.digick.jp/javascript/jquery.clickablecanvas.html> (accessed 2014.03.25)
- WordPress (2014) WordPress. <http://wordpress.org> (accessed 2014.03.25) (in Japanese)
- Yahoo! JAPAN(2014) Japanese morphological analysis API, <http://developer.yahoo.co.jp/webapi/jlp/ma/v1/parse.html>(accessed 2014.03.25) (in Japanese)

Digital Storytelling for Professional Socialization Through Cartooning Preservice Working Experience: A Case Study

Toshio MOCHIZUKI ^{a*}, & Takeshi KITAZAWA ^c

^a*School of Network and Information, Senshu University, Japan*

^b*Faculty of Education, Tokyo Gakugei University*

*tmochi@mochi-lab.net

Abstract: New teachers are often shocked at real school situations such as rules of local schools, human relationships in an enclosed environment, and the reality of teaching children. Also, some teachers cannot adapt to the working situation and tend to leave the workforce within a few years. It has become necessary to educate student teachers in the universities with a focus on adaptive professional socialization of teachers to overcome this problem. In order to address this issue, we introduced digital storytelling so that student teachers can visualize the prospective image of their practicum before it begins, and then reflect on their working experiences at the school after their practicum, taking into consideration the school situations. This digital storytelling aims to broaden the student teachers' perspective on schools as a workplace, by having them describe and share their working experiences. As a result, the student teachers could direct one's attention to the different characteristics of various schools as well, rather than just focusing on their teaching experiences.

Keywords: Digital story telling, cartoon, teacher education, professional socialization, practicum

1. Introduction

Many of the previous research focused on how to increase Pedagogical Content Knowledge (PCK) of teachers (e.g. Darling-Hammond & Bransford, 2005) when considering teachers' adaptive metacognition of a new era (Lin et al., 2005). However, in order for teachers to adapt to tackle big complex problems at schools, there is a need to focus on teachers' adaptive professional socialization (Zeichner & Gore, 1990).

The reason behind this is that the turnover rate within a few years of new teachers is high due to the reality shock they face, such as rules of the local school, human relationships, and the reality of the children (e.g. Hebert et al., 2001; Hong, 2010). As one of the reasons, a previous research pointed out that there is a gap between the teacher education at universities and the actual work at the schools, such as the teacher of the course not overlooking the pre-service teachers during the practice teaching. (Zeichner, 2010). While it has become a global trend for pre-service teachers to add on to their experience through long-term practice teaching, it is difficult for them to acquire sufficient professional socialization, since the experiences of teaching largely depend on the practice schools; they experience both successful as well as unsuccessful experiences; and the teaching of the university mentors during their practice teaching focuses mainly on PCK (Herbert et al., 2001).

We have provided a weblog community where pre-service teachers could have a dialogue based on their reports on experiences during their practice teaching, as a part of the preparation and reflection of the practice teaching (Mochizuki & Kitazawa, 2009; Kitazawa & Mochizuki, 2013). The closed community of pre-service teachers lack real-life working experiences in schools, so a course design where experienced teachers can participate, such as in pre-teaching and the weblog community, and motivate pre-service teachers to adapt professional socialization is needed. This previous research suggested that the weblog community became an important resource about professional socialization through not only providing opportunities to discuss and review mutually the practical knowledge which they learned during their practice teaching, but also through exchanging

information regarding how to communicate to children and other teachers which they could not learn at their universities, and about ways of adapting to problems at school.

In order to promote the professional socialization of pre-service teachers, as a next step of our prior research, we wish to examine the effectiveness of digital storytelling which allows the pre-service teachers to share various information regarding the practicum schools deeply with the imaginary information of their experience. Our ultimate goal is to design a learning environment that will efficiently prepare teachers with adaptability skills and a realistic view of the real-world classroom.

2. Digital Storytelling and Professional Socialization of Pre-service Teachers

Digital storytelling as a reflective tool for teacher education portfolios has been explored for these years (Barrett, 2008; Kearney, 2009). Storytelling is the oldest means for communicating ideas, sharing meaning and developing community (Egan, 1995). Bruner (1991) argued that narrative is one of the cultural products utilized by the mind to construct its sense of reality, and finally he extends the concept of personally constructed narrative into the shared experience of storytelling thus allowing the merging of individual private experience into culturally negotiated universals (Bruner, 1996). Kearney (2009) explored to link the two dynamic processes of digital storytelling and portfolio development to promote deep learning, asking the freshmen student teachers to collect artefacts from their on-campus and field-based learning experiences that showed their understanding of becoming a member of the workplace in an actual school, and compose their portfolio in the form of a digital movie and text on a paper. However, this study only focused on teaching experience in the practicum and subject-based learning in their on-campus classes.

Although such reflective activity on learning subjects and teaching experience is important, the adaptive professional socialization of teachers cannot remain at the level of the classroom because such ecological conditions are themselves products of policy decisions, political actions, and other influences at levels beyond the classroom, and the student teachers often encounter such issues during their practicum. Fenstermacher (1980) has argued that teachers' experiences with the institutional characteristics of schools are the most potent determinants of their perspectives toward teaching.

We would like to explore the possibility of digital storytelling where the student teachers describe and share their working experiences in order to broaden their perspectives of schools as a workplace, which is associated with adaptive professional socialization of teachers. In order to help the student teachers create digital storytelling about their working experiences, the VoicingBoard (Suzuki, et al., 2008) is used for the simulation (Figure 1). The VoicingBoard system makes it possible to easily draw cartoons on Internet browsers. Users create cartoons by simply dragging and

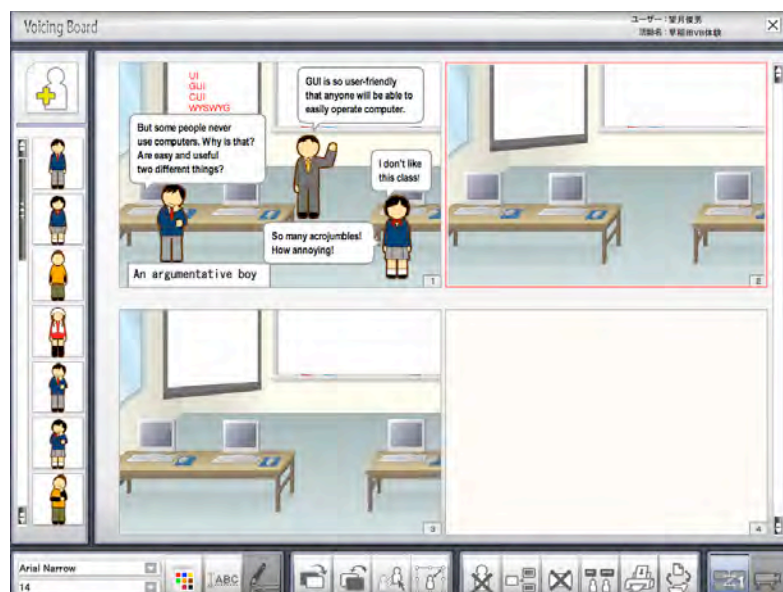

Figure 1. An example of usage of VoicingBoard, describing the teaching procedure.

dropping actors from the actor list onto one of the cells. Deleting and copying an actor can be done by simply clicking on the function buttons. Background images are also provided to enhance the reality of the cartoon. This simple operation allows learners to draw and revise their own cartoons with greater ease. In addition, drawing cartoons using various actor characters encourages the users' thoughts to be more actor-based because users are forced to select an actor first, before creating the story of the cartoon (Mochizuki, et al. 2010).

3. Research Design

3.1 Course Outline

The classroom practice which was studied in this research is "Pre-service Teacher Training 2," taught by one of the authors at a private university in Japan from April to July 2013. This course was a lesson held before and after practice teaching in an actual school for two or three weeks as a pre-service training. The student teachers who participated in this study were seven senior students (five male and two female). In the sessions held prior to the practice teaching, the pre-service teachers aimed to prepare for the practicum, acquiring step-by-step the necessary teaching skills and to brush-up their skills to create teaching plans, blackboard writing plans, and educational materials, through mutual evaluation of the teaching plans and trial lessons with the practice school. The lesson after practice teaching aimed to create a teaching portfolio so that they reflected on their practice teaching. Regarding one of the students, the practicum at the school was held in November, so he did only the activities for preparation of his practice teaching. Number tables and figures consecutively, not section-wise.

3.2 Development of digital storytelling about institutional experience in the course

Both before and after the practice teaching, the students were required to tell their experience in the form of a cartoon story. The first cartoon aimed to prompt the student teachers to imagine their life in the workplace including problems, accidents, politics, work besides teaching, etc.. The second cartoon aimed to encourage the student teachers to reflect on their experiences in the practicum from the viewpoint of the institutional characteristics of schools. After the student teachers created their cartoon stories, each of them was required to tell his/her own story, showing each panel of his/her cartoon, in front of other colleagues in the classroom, before and after their practicum.

3.3 Data collection

In this study, we acquired the following three data as preliminary evaluation. First, at the end of the course before the summer vacation, we conducted a questionnaire in order to gather subjective evaluation regarding digital storytelling. Secondly, based on findings of the questionnaire, we conducted interviews about the digital storytelling. Five students participated in the interviews. Thirdly, we analyzed the diaries written as weblogs to see how much the students wrote about working in school as teachers, and whether they have taken into consideration the institutional characteristics of the school.

Regarding the analysis, we referred to Hong (2010) who is exploring institutional factors as a reason for teachers leaving their jobs. Hong analyzed the relationship among six factors: 1) commitment, 2) value, 3) emotion, 4) micropolitics, 5) efficacy and 6) knowledge and beliefs. Therefore, in this research, we defined six categories: 1) commitment towards work, 2) value and standpoint as teachers, 3) emotion, 4) micropolitics, 5) efficacy and 6) knowledge and beliefs for teaching. Furthermore, to analyze the contents of reality shock and job adjustment (e.g. Weinstein, 1988; Herbert & Worthy, 2001), we created two additional categories: 7) expectations and the reality of schools, and 8) social behavior as professionals. In this research, we focused on a total of nine

categories (eight categories above-mentioned and 9) others), and we also analyzed the contents of the diaries and comments which was submitted to the weblog community.

The first author and the second author independently analyzed the categories of the diaries of the year 2012 and the year 2013. If the diary had multiple categories, we counted each category. Additionally, when opinions regarding categorization did not match, we decided through discussion. We have also collected the cartoons as data, but we will not refer to their contents in this research.

4. Findings

4.1 Subjective Evaluation of digital storytelling

Table 1 shows the results of the questionnaire regarding the storytelling. Although one student teacher could not answer the second question because his practicum did not start when the survey was conducted, we can see that the overall evaluations are almost all positive.

Table 1: Questionnaire regarding the storytelling

Question item	Strongly Agree	Agree	Disagree	Strongly Disagree
1. Creating the story prior to practice teaching was helpful in preparing for the practice teaching. (<i>n</i> =7)	2	4	1	0
2. Creating the story after the practice teaching was helpful in reflecting about the profession and work life of teachers. (<i>n</i> =6)	2	4	0	0

4.2 Analysis of the Content of Diary Entries

Table 2 indicates the results of the analysis of the content of diary entries. We can see that there is an increase in diary entries in the categories of Commitment Towards Work, Micropolitics, and Social Behavior as Professionals. We can see that mentions of aspects of teacher's work other than teaching, such as professional conduct as teachers and micropolitics within the organization, increased. This suggests that student teachers had become cognizant of the practical daily concerns of working as teachers.

Table 2: Results of the number of categorized diary entries within the weblog community

Categories	Year 2012 (<i>n</i> =8)	Year 2013 (<i>n</i> =6)
	Diaries	Diaries
1) Commitment Towards Work	29 35.4%	51 62.2%
2) Value and Standpoint as Teachers	25 30.5%	21 25.6%
3) Emotion	50 61.0%	57 69.5%
4) Micropolitics	0 0%	6 7.3%
5) Efficacy	35 42.7%	53 64.6%
6) Knowledge and Beliefs for Teaching	49 59.8%	46 56.1%
7) Expectation and Actuality of Schools	27 32.9%	26 31.7%
8) Social Behavior as Professionals	45 54.9%	51 62.2%
Total	84 (Average 10.5)	82 (Average 13.7)

4.3 Student Teachers' Reactions in the Interview

As mentioned above, before the practice teaching, the student teachers were asked to visually storytell how they would imagine themselves to be acting in a classroom, which would be a new environment for them. A response by a student is as follows.

I was wondering what the first day would be like, because I didn't have any know-how. If I hadn't drawn anything, it would probably been a very passive practice teaching experience. By drawing the cartoon, I was able to simulate what a day would be like, and think of what I would be doing. I think these are effects of drawing the cartoon. (Student C, male)

Another student also expressed that by implementing storytelling that utilizes the VoicingBoard before the classroom practice teaching, the system aided her to simulate practice teaching and the actions and behaviors she would be taking in the school. This student's response supports the answer to the questionnaire, where a majority of the student teachers responded that storytelling before practice teaching was useful in preparing one's mindset and attitude. Furthermore, by implementing storytelling, there is a possibility that it promotes the students to think about preparing for practice teaching, or about the work and work life of teachers.

However, we also saw cases where some meaning was confirmed in storytelling before practice teaching, but the reality in the actual classroom differed.

I think it was meaningful that we imagined what it would be like before the practice teaching, but the reality was quite different from what I had imagined. It was strenuous, problems occur, and the students didn't respond. I imagined mostly positive things, but that was not so - rather, negative things happened more, so I would probably draw those things in the cartoon I'd draw after the practice teaching. (Student B, female)

It is important that reality gaps such as this is avoided, but we consider it meaningful that the student was able to realize that there are gaps, and thought it was necessary to convey the discovery as a characteristic of the workplace.

After the practice teaching, we asked about the storytelling which the purpose is to reflect on one's actions during the practice teaching. We had the following response from a student.

After drawing, I realized points where I thought 'I should have done this,' and unless you reflect on what happened, you tend to forget. It becomes a thing of the past. However, by drawing the cartoon, you remember and have a chance to reflect, and it becomes possible to pass down the knowledge by sharing on the weblog community or a diary. (Student C, male)

As with the example above, all students who experienced practice teaching responded that conducting storytelling that utilizes the VoicingBoard after the practice teaching promotes reflection of the practice teaching and on oneself. Therefore, we found that storytelling both before and after the practice teaching is effective on promoting reflection. Furthermore, by creating stories based on their experiences and sharing them, the knowledge can be passed down and given as advice to future students (Schwartz, et al., 1999).

5. Conclusion and Future Issues

In this research, we implemented storytelling before and after the practice teaching, in order to promote the professional socialization of student teachers. Before the practicum, Student teachers shared their image of prospective practice teaching and a variety of their actual working experiences, focusing on various school's characteristics. As a result, we can say that they were prompted to think about preparations for the practice teaching, and about the work and work life of teachers. Future avenues of research are recommended as follows:

- It is not yet relevant how storytelling influences the change in thoughts of an individual student. It is necessary to analyze from an organizational socialization perspective regarding the content

of the story and the process of the change; how the student captures the teaching profession in each process; and how they view their daily activities in practice teaching.

- It is necessary to analyze how the students process and give meaning to the storytelling of other students and their seniors.

Acknowledgements

This research was supported by JSPS KAKENHI Grants-in-Aid for Scientific Research on Scientific Research (A) (No. 24240105) from the Japan Society for the Promotion of Science.

References

- Bruner, J. (1991). The narrative construction of reality. *Critical Inquiry*, 18(1), 1-21.
- Bruner, J. (1996). *The culture of education*. Cambridge, MA: Harvard University Press.
- Darling-Hammond, L. & Bransford, J. (Eds.) (2005). *Preparing teachers for a changing world*. San Francisco: Jossey Bass.
- Egan, K. (1995). Narrative and learning: A voyage of implications. In H. McEwan & K. Egan (Eds). *Narrative in teaching, learning, and research* (pp. 116 – 125). NY: Teachers College Press.
- Fenstermacher, G. (1980). On learning to teach from research on teacher effectiveness. In C. Denham & A. Lieberman (Eds.), *Time to learn* (pp. 127-137). Washington, DC: U.S. Dept. of Education.
- Hebert E. & Worthy T. (2001). Does the first year of teaching have to be a bad one? A case study of success, *Teaching and Teacher Education*, 17, 897-911.
- Hong Y. (2010). Pre-service and beginning teachers' professional identity and its relation to dropping out of the profession, *Teaching and Teacher Education*, 26, 1530-1543.
- Kearney, M. (2009). Investigating digital storytelling and portfolios in teacher education. In G. Siemens & C. Fulford (Eds.), *Proceedings of World Conference on Educational Multimedia, Hypermedia and Telecommunications 2009* (pp. 1987-1996). Chesapeake, VA: AACE.
- Kitazawa, T., & Mochizuki, T. (2013). Bridging Campus Courses and Field Experiences in University-based Teacher Education Program Using Online Diaries. In L.-H. Wong, et al. (Eds.) *Proceedings of the 21st International Conference on Computers in Education* (pp.222-227). Indonesia: Asia-Pacific Society for Computers in Education.
- Lin X., Schwarz, D., & Hatano, G. (2005). Toward Teachers' Adaptive Metacognition, *Educational Psychologist*, 40(4), 245-255.
- McDrury, J. & Alterio, M. (2002). *Learning through storytelling in higher education: Using reflection and experience to improve learning*. London: Kogan Page.
- Mochizuki, T. & Kitazawa, T. (2009). Designing a Learning Community for the Pre-Service Teacher Training Using the Social Networking Service. In Kong, S.C., et al. (eds.), *Proceedings of the 17th International Conference on Computing in Education 2009* (pp. 316-320). Hong Kong: Asia-Pacific Society for Computers in Education.
- Mochizuki, T., Kubota, Y. & Suzuki, H. (2011). Cartoon-based teaching simulation: How student teachers consider their lesson plans during the simulation. In M. Koehler & P. Mishra (Eds.), *Proceedings of Society for Information Technology & Teacher Education International Conference 2011* (pp. 2165-2170). Chesapeake, VA: AACE.
- Schwartz, D. L. , Lin, X., Brophy, S., & Bransford, J.D. (1999). Toward the development of flexibly adaptive instructional designs. In C. M. Reigeluth (Ed.), *Instructional Design Theories and Models: Volume II* (pp.183-213). Hillsdale, NJ: Lawrence Erlbaum Associates.
- Suzuki, H., Kato, H., & Nakamura Y. (2008). Supporting multivoiced construction of presentation story —VoicingBoard: A system that supports Manga-based thinking—. In J. Luca & E. Weippl (Eds.), *Proceedings of World Conference on Educational Multimedia, Hypermedia and Telecommunications 2008* (pp. 4423-4428). Chesapeake, VA: AACE.
- Weinstein, C. S. (1988). Preservice teachers' expectations about the first year of teaching. *Teaching and Teacher Education*, 4, 31–40.
- Zeichner, K. & Gore, J. (1990). Teacher Socialization. In W. R. Houston (Ed.), *Handbook of Research on Teacher Education* (pp. 212-233). New York: Macmillan
- Zeichner, K. (2010). Rethinking the connections between campus courses and field experiences in college- and university-based teacher education. *Journal of Teacher Education*, 61(1-2), 89-99.

Do They Keep Technology in Mind? An Implementation of TPACK-oriented Science Teacher Program for Science Degree-graduated Students

Niwat SRISAWASDI^{a*} & Patcharin PANJABUREE^b

^a*Faculty of Education, Khon Kaen University, Thailand*

^b*Institute for Innovative Learning, Mahidol University, Thailand*

*niwsri@kku.ac.th

Abstract: Science-based education in 21st century needs qualified and innovative science teachers who are expertise in using information and communication technology as pedagogical tool for their work and as cognitive tool for student learning. As such, a framework of Technological Pedagogical and Content Knowledge (TPACK) has been recognized as a theoretical basis for development of professional science teacher. This paper reported a pilot study result of implementing TPACK-focused preservice science teacher program for science degree-graduated students. The study participants were 54 preservice science teachers in a master degree of education at Khon Kaen University, Thailand. The alignment of 2-year courses has been particularly designed based on TPACK for students who graduated in 4-year bachelor degree of science. The results showed that the preservice science teachers have been cultivated their technological pedagogical knowledge (TPK) and technological content knowledge (TCK) during enrollment in the program. This could be implied that the TPACK-based approach should be used as a basis to create well-designed coursework in teacher education program.

Keywords: Technological Pedagogical Content Knowledge, preservice teacher, science education, teacher education

1. Introduction

In today's world, information and communication technology (ICT) have become commonplace in improving and advancing the practice of education because of its potential of bringing about change in ways of teaching and learning. In light of technological advancement, in science education community of practice, there is a wide range of efficient technological environments and applications that can serve science teaching and learning (e.g. animations, simulations and modeling tools, microcomputer-based laboratories (MBL), intelligent tutoring systems, web resources and environments, spreadsheets, scientific databases, etc.) for both students and teachers (Srisawasdi, 2014). According to its features, these tools could provide opportunities for active learning, enable students to perform at higher cognitive levels, support constructivist learning, and promote scientific inquiry and conceptual change (Jimoyiannis, 2010). As such, there is a worldwide call for professional science teachers who are able to comprehensive use of ICT, and the challenge for teacher education in this century is to discover effective ways to prepare literate preservice science teachers and also to professionally develop inservice science teachers.

Over the last decade, traditional educational practice in teacher education no longer provide prospective teachers with all the necessary skills for teaching student to cope with this current knowledge-based society, especially in the fast changing world of early 21st century (Srisawasdi, 2014). Currently, Technological Pedagogical and Content Knowledge (TPACK) is a theoretical basis for development of teachers' expertise with respect to the integration of information and communication tools (ICT) into teaching and learning activities for particular subject matter (Koh & Chai, 2011). TPACK illustrates essential knowledge of how teachers could integrate technological tools into their

teaching of specific content in their school practice (Jimoyiannis, 2010; Srisawasdi, 2012). Research indicated that the experienced teachers seem reluctant to incorporate educational technology in schools, while preservice teachers and newly qualified teachers are more confident users of educational technology in classroom and are more willing to learn and adapt educational technology in their classroom practices (Madden, Ford, Miller, & Levy, 2005; Sime & Priestley, 2005; Anderson, 2006). In science education, it is, however, still not clear how best to prepare science teachers who are competent in using and managing educational technologies to support their teaching practice and enhance students' understanding about science (Srisawasdi, 2014).

To address the above issue, a pilot study was conducted to explore a preliminary result of an implementation of TPACK-focused preservice science teacher program for science degree-graduated students. This study seeks to describe preservice science teachers' technological pedagogical knowledge and technological content knowledge after finishing one-year coursework in the program. Moreover, this paper aims to provide evidence of preservice science teachers' use of the TPACK framework resulting from the preservice science teacher education program. Finally, implications for the design of preservice science teacher program for science degree-graduated students then are discussed.

2. Technological Pedagogical and Content Knowledge (TPACK) and Teacher Education

TPACK is currently an important fundamental framework in community of research and practice for educational research, especially in teacher education (Chai, Koh, & Tsai, 2010; Jimoyiannis, 2010; Srisawasdi, 2014). According to the framework, many studies showed that teachers who demonstrate TPACK can effectively integrate their knowledge of technology with their pedagogical and content knowledge to promote student learning (Niess, 2008; Harris and Hofer, 2011; So and Kim, 2009). In this light for science teacher education, both preservice and inservice science teachers are targeted to improve teaching proficiency based on the implementation of TPACK in many kinds of instructional intervention i.e. coursework (e.g. Niess (2005), Jimoyiannis (2010), Jang & Chen (2010), Srisawasdi (2014)), training (e.g. Hennessy et al. (2007), Guzey & Roehring (2009), Alayyar et al. (2012), and workshop (e.g. Annetta et al. (2013))). As such, it is clearly that the development of science teacher education program based on TPACK framework is important in order to prepare and cultivate science teacher for gaining high quality teaching competencies by integrating technologies into their science teaching practice.

3. General Description of Science Teacher Education in Thailand

In Thailand, there are two main pre-service science teacher education programmes. The 5-year undergraduate degree programme known as the Bachelor of Education (B.Ed.) programme is the programme which offer candidates the choice of teaching at either the primary or secondary levels of science education. The 5-year preservice science teachers have to enroll in all compulsory coursework for four years and then complete one year of school internship. The another preservice programme is 2-year Postgraduate Master of Education (M.Ed.) for teaching at the upper secondary education level for those who already possess at least a Bachelor's Degree of Science (B.Sc.), called The Promotion of Science and Mathematics Talented Teachers (PMST) program. For this programme, the preservice teacher have to enroll in all compulsory coursework in three semesters for one year and then complete one year of school internship and conduct their Master's degree theses at the same time.

4. Research Methodology

4.1 Study Participants

A total of 54 PMST preservice science teachers enrolled in Master Degree of Education in Science and Technology Education programme at Faculty of Education, Khon Kaen University, Thailand,

were the study participants. These teachers were in the third semester of their M.Ed. programme in academic year 2013. They were 14 preservice physics teachers, 20 preservice chemistry teachers, and 20 preservice biology teachers. They were 43 females and 11 males and they age between 23-25 years old. About twenty-five percent of the preservice teachers had a job before attending this programme and another just finished a Bachelor's degree of Science. About fifty percent had experience working with children in a classroom setting or in a tutoring situation.

4.2 Details of the Course Arrangement

In order to cultivate TPACK for the preservice science teachers, a series of coursework in M.Ed. Science and Technology Education at Faculty of Education, Khon Kaen University was particularly designed for science degree-graduated student. At the faculty, preservice science teachers completed a sequence of five science education method courses across three semesters. The program faculty for science education teacher preparation had infused research-based strategies as well as student-centered approaches into the program. Thus, a commitment to modeling student-centered approaches and learning from authentic and up-to-date researches were evidence in the instructor's values for these method courses. For example, the courses of technology-enhanced learning in science education was conducted in a manner that the instructor minimized content delivery via lecture and engaged students in many active learning activities, such as small group discussions, panel presentations, and team planning workshops, as well as the professional laboratory practice in science education. Also, scenarios, examples and problems that are important both in workplace and in society in general were crucial in these course. However, they also undertook four general methods courses in the first two semesters.

4.3 Data Collection and Analysis

The researchers collected data by considering the preservice science teachers' poster presentation during an intensive seminar organized in the last three weeks of the third semester. All the preservice science teachers were presenters and they were assigned to create a poster and present their science teaching ideas and research in science education to science educators in ten minutes. After each poster presentation, they were asked by four science educators to clarify their thought for 5 minutes. The researcher performed the content analysis of the preservice science teachers' TPACK based on their poster contents and presentations, and the question-answer session. Inter-rater agreement was conducted by two raters and the reliability was, finally, established a completed agreement. For this pilot study, the majority of the study was on the preservice science teachers' technological knowledge (TK), technological pedagogical knowledge (TPK), and technological content knowledge (TCK) only. Each knowledge type was coded into three types of knowledge related technology in TPACK framework. Moreover, characteristics of TK-PK interaction and TK-CK interaction also were investigated in order to describe their thought about using technology in science teaching and learning. For TK-PK interactions, T-disassociated PK extents to which instructor uses technology separately from teaching strategy selected. T-assisted PK extents to which instructor uses technology as a supporting tool to teach following the selected strategy. T-enhanced PK extents to which instructor pedagogically involves technology into the process of learning by its nature, as a part of learning process. Finally, T-transformed PK extents to which instructor pedagogically use technology to transform regular learning process following a specific learning model or teaching strategy.

5. Results and Discussions

Results showed that about a half of the preservice science teachers (51.85%) thought about the use of technology in their own research and teaching ideas. From the content analysis, the preservice science teachers' research and teaching ideas on the poster presentation were coded inductively and then identified their teaching idea on the use of technology. The results of technology used for their research and teaching ideas was presented in Figure 1.

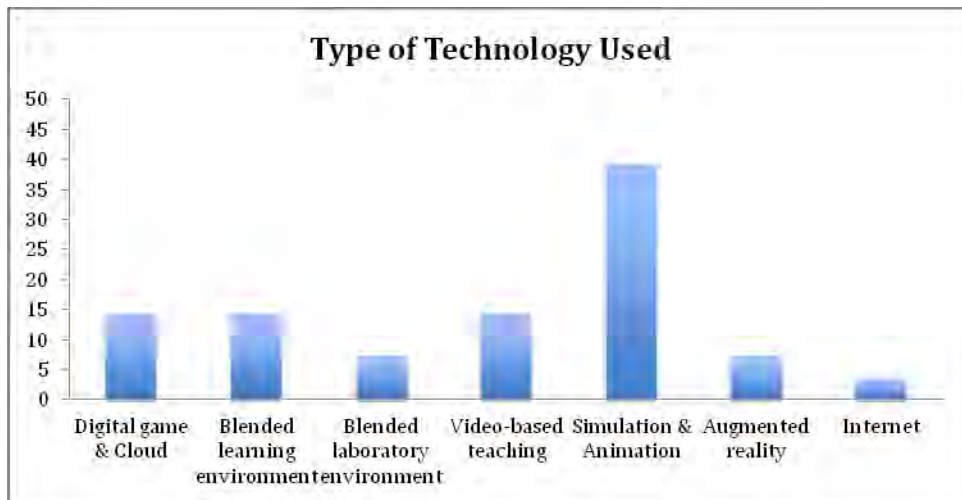

Figure 1. Percentage of type of technology used for the preservice science teachers’s research and teaching ideas

A graphical representation of Figure 1 showed that the preservice science teachers favor to use digital technology in science lesson. Most of them (39.29%) recognized that scientific visualization technology such as simulation and animation was a pedagogic tool for science teaching and learning. About 14.29% of them who selected to use digital game & cloud technology, blended learning environment by microcomputer-based laboratory (face-to-face) and web-based inquiry science environment (online), and video-based teaching, respectively. In additions, they decided to use blended laboratory environment by microcomputer-based laboratory (actual lab) and computer simulation (virtual lab), and augmented reality technology in 7.14% each type. Only one of them (3.57%) decided to employ internet for student’s inquiry in science class.

In Figure 2 and 3 that follows, it presents the percentage of coded segments over the poster presentation for each of four categories of TK-PK interaction, and TK-CK interaction, respectively.

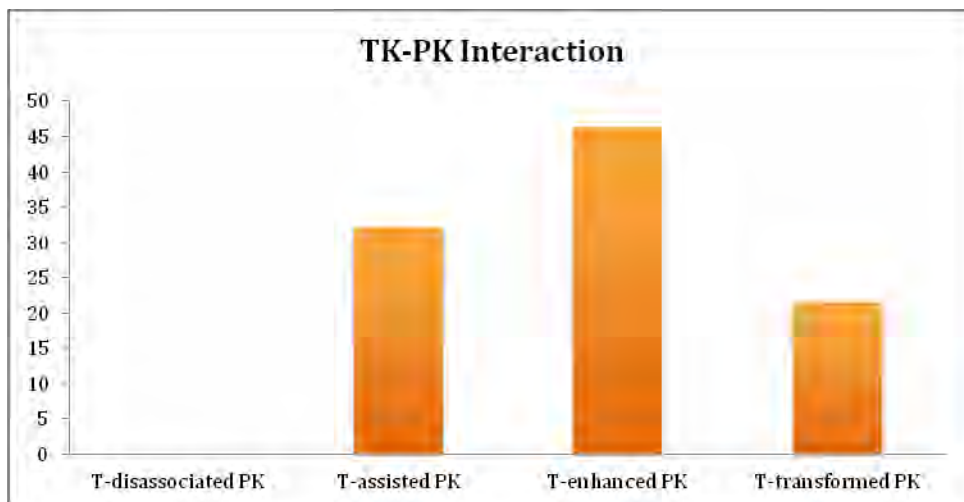

Figure 2. Percentage of characteristics of TK-PK interaction on the use of technology for science teaching and learning

According to the TK-PK interaction result, it showed that all of the preservice science teachers who decided to use technology in science lesson could identify how to pedagogically use technology for science teaching and learning. There were 46.43%, 32.14%, and 21.43% of them who could use technological tools to enhance (T-enhanced PK), assist (T-assisted PK), and transform (T-transformed PK) pedagogy of science teaching and learning, respectively, in their research and teaching ideas, as seen in Figure 2.

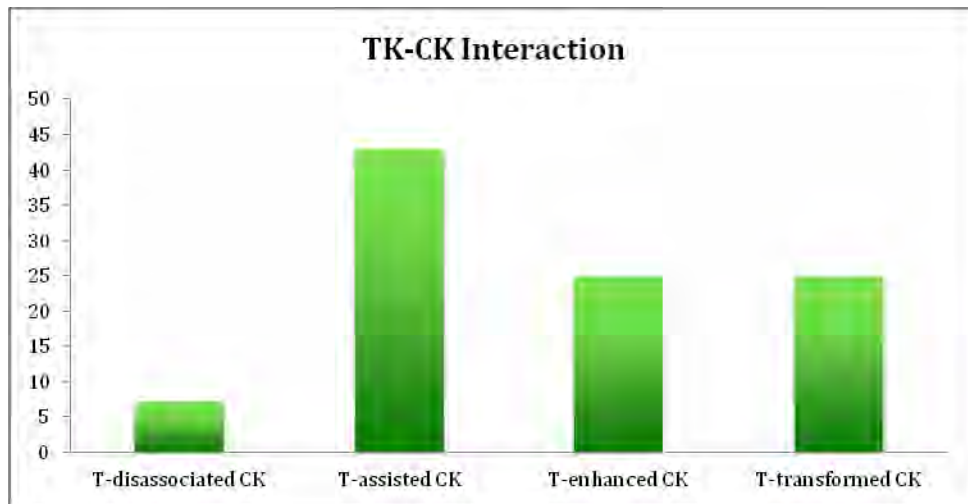

Figure 3. Percentage of characteristics of TK-CK interaction on the use of technology for science teaching and learning

According to Figure 3, the result on TK-CK interaction revealed that 93.86% of them understood the ways to use technology to simplify scientific knowledge. In the other words, there was 42.86% of them could use technological tools to assist (T-assisted CK) the presentation of scientific knowledge to student. Another, they proposed to use technological tools in a manner of enhancement (T-enhanced CK) and transformation (T-transformed CK) of scientific knowledge in 25.00% each characteristics.

In a summary, the results of this pilot study provided evidences that the preservice science teachers' TPK and TCK has been cultivated during their enrollment in the TPACK-oriented science teacher program for science degree-graduated student. This finding is consistent with Jimoyiannis (2010), Jang & Chen (2010), and Srisawasdi (2014) that implementation of well-designed coursework could foster preservice or inservice science teachers' essential knowledge of TPACK. As the measure of the TPK and TCK, the results indicated that the preservice science teachers' perceptual understanding on the ways to use technological tools to enhance pedagogy of science teaching (T-enhanced PK) is higher than others, compared to the use of technology to assist (T-assisted PK) and transform (T-transformed PK) the teaching of science. According to their TPK and TCK development, the preservice science teachers' TPK was more prevalent than growth in their TCK. This finding is consistent with Graham, Cox, & Velasquez (2009) who have reported that science teachers significantly increased their TK, TPK, TCK, and TPCK after attending a university-based professional development focused upon content, inquiry-oriented pedagogy, and educational technologies, and the TCK had the lowest mean score for their development. However, the findings of this study clearly showed the need for further classes or coursework in order to complete preservice science teacher's TPACK.

6. Conclusion and Implication

This paper reported a pilot study result of an implementation of TPACK-oriented science teacher program in context of two-year Master degree of Education in Science and Technology Education for graduate student who finished four-year bachelor's degree of science. In TPACK-oriented science teacher program, the preservice science teachers have been fostered their TPK and TCK in science teaching and learning. In an effort to better serve the needs of high quality science teachers, the results of this pilot study illustrated that the TPACK-oriented program for science teacher could be particular considered as a potential attribute for development of science teacher education in future. Therefore, an implication of this is the possibility that TPACK-based approach for professional development should be implemented into courses of teacher education program in a long time in order to effect any lasting changes and completion in preservice science teacher's TPACK.

Acknowledgement

The author wishes to gratefully acknowledge the financial support by Faculty of Education, Khon Kaen University, Thailand.

References

- Alayyar, G. M., Fisser, P., & Voogt, J. 2012. "Developing technological pedagogical content knowledge in pre-service science teachers: Support from blended learning". *Australasian Journal of Educational Technology*, 28(8), 1298-1316.
- Andersson, S. B. (2006). Newly qualified teachers' learning related to their use of information and communication technology: A Swedish perspective. *British Journal of Educational Technology*, 37, 665–682.
- Annetta, L., Frazier, W., Folta, E., Holmes, S., Lamb, R., & Cheng, M.-T. (2013). Science teacher efficacy and extrinsic factors toward professional development using video games in a design-based research model: The next generation of STEM learning. *Journal of Science Education & Technology*, 22(1), 47–61.
- Chai, C. S., Koh, J. H. L., & Tsai, C. C. (2010). Facilitating preservice teachers' development of technological, pedagogical, and content knowledge (TPACK). *Journal of Educational Technology & Society*, 13(4), 63–73.
- Graham, C. R. (2011). Theoretical considerations for understanding technological pedagogical content knowledge (TPACK). *Computers & Education*, 57(3), 1953–1960.
- Guzey, S. S., & Roehrig, G. H. (2009). Teaching science with technology: Case studies of science teachers' development of technology, pedagogy, and content knowledge. *Contemporary Issues in Technology and Teacher Education*, 9(1).
- Hennessy, S., Wishart, J., Whitelock, D., Deane, R., Brawn, la Velle, L., McFarlane, A., et al. (2007). Pedagogical approaches for technology-integrated science teaching. *Computers & Education*, 48(1), 137–152.
- Harris, J., Mishra, P., & Koehler, M. J. (2009). Teachers' technological pedagogical content knowledge and learning activity types: Curriculum-based technology integration reframed. *Journal of Research on Technology in Education*, 41(4), 393–416.
- Harris, J.B. & Hofer, M.J. (2011). Technological Pedagogical Content Knowledge (TPACK) in action: A descriptive study of secondary teachers' curriculum-based, technology-related instructional planning. *Journal of Research on Technology in Education*, 43(3), 211-229
- Jang, S. J., & Chen, K. C. (2010). From PCK to TPACK: Developing a transformative model of pre-service science teachers. *Journal of Science Education and Technology*, 19(6), 553-564,
- Jimoyiannis, A. (2010). Designing and implementing an integrated technological pedagogical science knowledge framework for science teachers professional development. *Computers and Education*, 55(3), 1259 – 1269.
- Koh, J.H.L., & Chai, C.S. (2011, December). Modeling pre-service teachers' technological pedagogical content knowledge (TPACK) perceptions: The influence of demographic factors and TPACK constructs. IN G.Williams, N. Brown, M. Pittard, B. Cleland (ED.) Changing Demands, Changing Directions. *Proceedings ascilite Hobart 2011*, 17, 735-746.
- Madden, A., Ford, N., Miller, D., & Levy, P. (2005). Using the Internet in teaching: The views of practitioners (A survey of views of secondary school teachers in Sheffield, UK). *British Journal of Educational Technology*, 36, 255–280.
- Niess, M. L. (2005). Preparing teachers to teach science and mathematics with technology: developing a technology pedagogical content knowledge. *Teaching and Teacher Education*, 21, 509–523.
- Niess, M. L. (2008). *Handbook of technological pedagogical content knowledge (TPCK) for educators* (pp. 223-250). Guiding Preservice Teachers in Developing TPCK (Eds.). New York: Routledge.
- Sime, D., & Priestley, M. (2005). Student teachers' first reflections on information and communications technology and classroom learning: Implications for initial teacher education. *Journal of Computer Assisted Learning*, 21, 130–142.
- So, H.-J., & Kim, B. (2009). Learning about problem based learning: student teachers integrating technology, pedagogy and content knowledge. *Australasian Journal of Educational Technology*, 25(1), 101–116.
- Srisawasdi, N. (2014). Developing Technological Pedagogical and Content Knowledge in Using Computerized Science Laboratory Environment: An Arrangement for Science Teacher Education. *Research and Practice in Technology Enhanced Learning*, 9(1). 123-143.

Evaluation of Three-Site Multipoint Distance Learning using High-Definition "HyperMirror"

Taiichiro OKUBAYASHI^{a*}, Akiko NAKAZAWA^b, Hideki MORI^c, Takanori MAESAKO^a & Osamu MORIKAWA^d

^aGraduate School of Human Sciences, Osaka University, Japan

^bKomaba Organization for Educational Excellence, the University of Tokyo, Japan

^cTeaching and Learning Support Center, Osaka University, Japan

^dTokyo Institute of Technology, Japan

*okubayashi@hus.osaka-u.ac.jp

Abstract: The purpose of this study is (1) to provide information about three-site multipoint distance learning utilizing the high-definition "HyperMirror" and (2) to determine how the video image quality of standard definition and high definition affect distance learning. We carried out distance learning projects twice in 2010, on (a) January 28th [Standard Definition] and (b) February 24th [High Definition], with middle schools in Nara and Kumamoto and the High Energy Accelerator Research Organization, Tsukuba in Japan. The three locations successfully connected using HyperMirror during the projects. Afterwards, a questionnaire survey revealed that image quality was not the sole contributing factor in the overall assessment of HyperMirror. However, it was suggested that easy-to-see figures, pictures, and remote students' facial expressions were important for students.

Keywords: Distance education/learning, HyperMirror, high-definition, multi-point

1. Introduction

A traditional videoconference or video chat transmits pictures that are captured by the camera for one-on-one or smaller group meetings, and the presence of another party and the atmosphere of the classroom are difficult to convey. As a solution to this, a special type of videoconferencing system called "HyperMirror" (HM) has been used successfully for distance learning. In HM, everyone appears in the same video image, in other words, everyone appears as if they are in the same room (Morikawa & Maesako, 1998). In comparison with the traditional videoconference, distance learning with HM has been confirmed to be more suitable for learning programs involving physical activities and sharing or interacting with documents/materials with the counterpart in a remote place (Imai, et al., 2002). In addition, HM proved that sharing the same space and working together virtually could make distance learning effective, despite the rather poor quality of image resolution (Matsukawa, et al., 2005).

Previous research on distance learning has shown to be of benefit of using high-definition (HD) rather than standard-definition (SD), e.g., it improved readability of text on the blackboard (Shimizu & Shiroma, 1990) and increased the feeling of high-presence distance education (Nishihara, et al., 2006)). In HM, the presented documents/materials were hard to see due to a lower-resolution format and insufficient bandwidth of the network. Therefore, HD technology was applied to HM with a wider bandwidth network, allowing a wider range of activities (Nakazawa, et al., 2009). However, whether the improvement of video image quality between SD and HD on HM affects participants' feelings has yet to be elucidated. It is possible for HM to construct more than a two-site connection, although HM has so far been done in point-to-point mode. Therefore, HM has yet to be elucidated fully concerning multipoint distance learning.

Thus, in this study, distance learning projects were conducted twice in 2010 among middle schools in Nara and Kumamoto and the High Energy Accelerator Research Organization, Tsukuba in Japan. The purpose of the research is (1) to provide information about three-site multipoint distance learning with HM and (2) to determine how the video image quality of SD and HD affect distance learning.

2. Outline of Distance Learning

2.1 Session Dates and Participants

Distance learning with HM connecting three locations was conducted on January 28, 2010, (1st session), and February 24, 2010 (2nd session). The three locations connected by HM were the High Energy Accelerator Research Organization (KEK) in Tsukuba City, Ibaragi, “N” middle school in Nara, and “M” middle school in Kumamoto. “N” middle school is located in Nara City with about 400 students in the 1st–3rd grades (equivalent to 1st–3rd grades in junior high schools). “M” middle school is located in a mountain region with about 130 enrollments in total. Two experts in “KEK” and students in Nara (1st session: 29 students; 2nd session: 20 students) and Kumamoto (1st session: 40 students; 2nd session: 15 students) participated in the distance learning.

2.2 Learning Program

As part of the outreach activities in cooperation with KEK, Center for Educational Research of Science and Mathematics, Nara University of Education develops educational programs that allow many learners to experience research on leading-edge topics in particle physics. In this exercise, instructors from these organizations and schools had examined feasible curriculums at real teaching environments and taught on the basis of those curriculums. In addition to the two distance learning sessions examined in this paper, one experimental lesson was held at each school. In the 1st session, the video quality was SD, and it consisted of three types of activities: introductions of their schools and KEK, joint classes on introductory subatomic physics taught by experts of KEK, and practical work (for N, hands-on learning in making wire chambers; for M, hands-on learning in measuring the angle of cosmic rays). In the 2nd session, the video quality was HD, and the session involved assigning follow-up tasks to each presentation, Q&A, and comments from KEK. The learning environment is the main focus of this paper, not the contents of the learning program.

3. Educational Merits of Three-Site Multipoint Distance Learning

In distance learning, practices with a traditional point-to-point videoconference such as between schools have been reported by numerous researchers. However, connecting more than two locations such as the practice here of including expert organizations and schools to carry out distance learning was unheard of. By connecting with expert organizations such as KEK, the students were able to experience and learn advanced research while being in their classrooms.

In addition, when connecting multiple locations in the traditional videoconference, every site receives numerous connected images as one combined image by connecting to the MCU (multipoint control unit). However, here we used HM so that we could more closely simulate the normal classroom environment while in a distance learning environment. With HM, it was necessary for each site to directly send and receive images reciprocally because of the need to combine images at each site. Thus, it was significant to talk about the connections when there were three connecting locations involved.

4. Network and Equipment Configuration

4.1 Network

In the two remote sessions, the three sites were connected with different networks. For the 1st session, terrestrial lines were used. Although the line installed at N school in Nara was of optical fiber, the actual bandwidth was about 1.5 Mbps and not suitable for the remote session considering the amount traffic from devices in the school. Therefore, a classroom in Nara University of Education, Japan, was hired as the venue, where the university network was used for the session (100 Mbps).

As for Kumamoto, the line used for M school was “Community Access Television” (CATV).

The line was shared with the town house and other local facilities, and while the bandwidth of M school was 5 Mbps, a preliminary test found its capacity limit at around several hundred kbps, which was barely sufficient to host a videoconference. The image transmission bandwidth for the videoconference system on the session day was fixed at around 96–384 kbps.

The second session was carried out mainly via the network under Kizuna, the ultrafast Internet satellite. Transportable antennas were set up at N and M schools to conduct communications through Kizuna. At KEK, no antenna was set up. Instead, an antenna at JAXA Tsukuba Space Center was used for communication with Kizuna. The exclusive terrestrial line connecting JAXA and KEK and the long distance wireless LAN connecting Tsukuba University and KEK were used to establish connections with Nara and Kumamoto. The connection bandwidth via Kizuna was set at approximately 17 Mbps (dual-direction) for each school and about 13 Mbps (dual-direction) for connection between JAXA Tsukuba Space Center and KEK (using the exclusive terrestrial line and a long-distance wireless LAN). The available bandwidth between each of the three locations, when connected simultaneously, was about 6 Mbps (dual-direction). As for the image transmission bandwidth during the session, the communication using the videoconference system was conducted at 4 Mbps.

4.2 Equipment Configuration

As the first session was done on SD while the second was on HD, the two sessions used different converter configurations, but the basic structures were almost the same. The following section explains the detailed structure of the learning environment, as shown in Figure 1.

First, blue screens were set up at the three locations to combine the three images through chroma key synthesis. Images from the camera of the expert standing in front of the blue screen were combined with the computer screen showing the lecture materials, and then the synthesized images were sent to Nara and Kumamoto. At the remote locations in Nara and Kumamoto, images of participants standing in front of blue screens were sent to the other two locations. Syntheses of images at one site with images received from other two locations were separately done at each location in order to minimize the impact of transmission delay. At KEK in Tsukuba, images of the expert combined with images from Nara, and images from Kumamoto were finally added to create an HM of the three locations. In Nara and Kumamoto, the respective images were first synthesized with the expert's images and then combined with pictures sent from the other school.

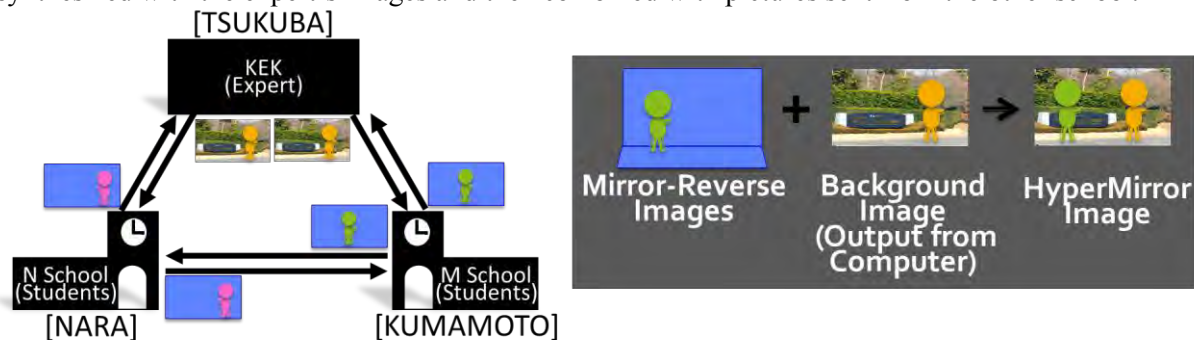

Figure 1. Simplified framework of distance learning with HM.

5. Scenes from the Distance Learning and Results of the Questionnaire Survey

5.1 Scenes from the Distance Learning

5.1.1 1st Session: HM with three locations via SD

At the first remote session, an SD network of HM connecting three locations was established. Although the resolution size was defined as SD, the network environment was limited as described before, so the image transmission bandwidth of the videoconference system was fixed at around 96 kbps between Tsukuba and Kumamoto, and 384 kbps between Tsukuba and Nara.

Figure 2 shows a scene from the actual distance learning. In this particular scene, five students

from Nara entered the picture to make a presentation. Figure 3 is the image of the expert in Tsukuba giving a lecture. The expert held a pointer with a tip in the shape of a big arrow. Figure 4 shows the PC image in Tsukuba prepared for presentation materials. The PC displayed the synthesized image made in Tsukuba featuring real-time classroom scenes of Nara and Kumamoto, which were transmitted between Tsukuba–Nara and Tsukuba–Kumamoto via video chat software. By displaying the scenes in this manner, participants were able to share the same image and learn what was going on at the other two sites. However, due to the specification limit of the video chat software, the image could not be enlarged, making the expert in Tsukuba lean in close to check the screen.

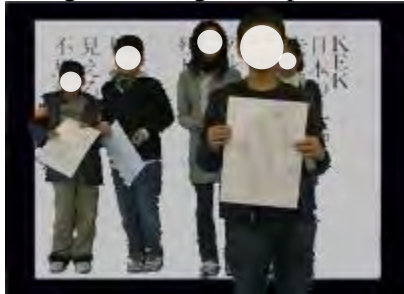

Figure 2. Students of N giving a presentation.



Figure 3. Expert lecturing with a background image.

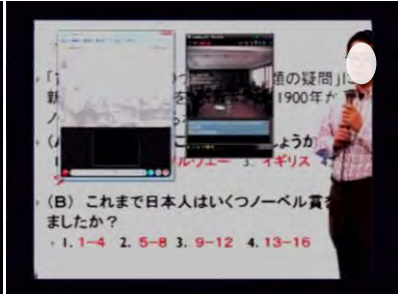

Figure 4. Real-time classroom scenes using video chats.

5.1.2 2nd Session: HM with three locations via HD

Figure 5 shows a presentation scene by students at the second remote class. In Figure 6, experts at Tsukuba were answering a question from students. Compared to the first remote session, the facial expressions were captured more clearly.

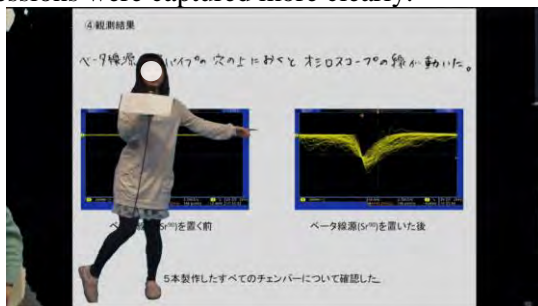

Figure 5. Students of N giving a presentation.

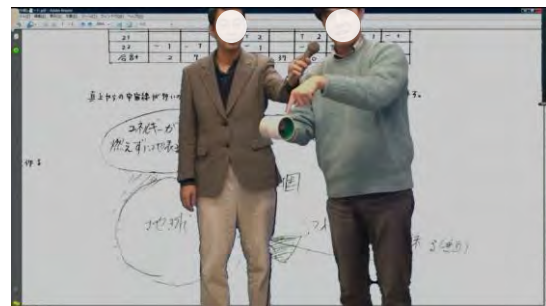

Figure 6. Experts answering the question.

5.2 Results of the Questionnaire Survey

5.2.1 Summary of Questionnaire

A questionnaire survey was conducted with students who had participated in the first and second remote classroom sessions. The questions are shown in Table 1. After each session, the questionnaire was distributed to the participating students at each school. The students answered each question by choosing one prepared answer ranging from “0: not applicable at all” to “10: very applicable.” Then, in order to compare the first and second learning environments, questionnaire sheets completed by students who participated in both sessions (16 students from Nara and 15 from Kumamoto) were selected from the collected sheets to make the analysis.

5.2.2 Results

In order to find out the average value and standard deviation (S.D.) of each question, as well as to confirm the difference between the questionnaire answers from the first and second sessions, a Wilcoxon signed-rank test was conducted on each item, the result of which is shown in Table 2. According to the Wilcoxon signed-rank test result, differences were observed in Q1–Q9 at the significant level of 1%, but no significant difference manifested on Q10.

Table 1: Questionnaire and its Average, S.D.
(Wilcoxon signed-rank test results [** indicates a significance at 1%])

		Average		S.D.		V-value
		1 st	2 nd	1 st	2 nd	
		(SD)	(HD)	(SD)	(HD)	
Q1	I saw texts clearly.	5.14	7.45	2.76	2.29	27**
Q2	I saw figures & pictures clearly.	4.79	7.83	2.44	2.12	7**
Q3	I saw the lecturer's facial expression clearly.	4.52	7.10	2.26	2.21	28**
Q4	I saw the remote student's facial expression clearly.	3.66	7.17	2.45	2.27	3**
Q5	I knew where the remote person was pointing with a pointer or finger.	6.07	8.52	2.66	1.84	16**
Q6	The video image was natural.	4.29	6.76	2.42	2.34	25**
Q7	Was it easy to watch the video image of remote participants?	4.55	7.48	2.49	2.31	10**
Q8	I could feel the mood of the remote participants.	4.96	7.76	2.50	1.84	27**
Q9	I felt like we were in the same room.	4.62	6.62	3.16	2.51	74**
Q10	The entire HM was good.	7.59	8.41	2.58	2.01	55

6. Possibilities of HM Connecting Three Locations and Comparison of Image Quality

6.1 Possibilities of HM Connecting Three Locations

The paper examines the usability of HM connecting three locations. Past trials using HM connected only two locations, but as this paper describes, distance learning connecting three different locations facilitated by HM was also proven to be successful. By using HM, the students at Nara and Kumamoto were able to experience research and learn about particle physics with experts involved and also exchange opinions with other students and experts. Furthermore, mutual communications and learning activities occurred without major problems. Because of the synthesized presentation materials in the background, participants in the three locations were able to learn by sharing the same materials. The three-location network demonstrated in this study may be useful in carrying out distance learning activities where students of two schools hold discussions with a remotely-located expert, like in the learning session introduced here, or engage with three schools located remotely from each other.

In addition, according to the opinions of the students, regardless of the picture quality, by being able to stand next to one another in the virtual shared space and shake hands gave a sense of closeness with the partner, a feeling of reality that made it easier to ask questions and learn together.

6.2 Comparison of SD and HD

With the results of the questionnaire survey conducted with the students, this paper compares HM with SD and HD. First, as to Q1–Q7 of the questionnaire referred to image quality, there was a significant difference between SD and HD. It was clarified that HD image quality was subjectively conceived as better than that of SD. Comparing the average score of the text (Q1) and the figure and picture (Q2), there was a difference between HD and SD (as to HD, Q1 [7.45], Q2 [7.83] increased by 0.38; as to SD, Q1 [5.14], Q2 [4.79] decreased by 0.35). If the average scores of Q1 and Q2 in the case of HD were similar (i.e., if there was no difference in the ease of seeing the text and figure), this seems like a plausible explanation for the difference. But in fact, the results showed the opposite. Thus, it was presumed that students had more need to see figures and pictures than text in distance learning. Applying the same logic to facial expressions of lecturers (Q3) and students (Q4), although there was no distinct difference in the case of HD (Q3 [7.1], Q4 [7.17] increased slightly by 0.07), there was a difference in the case of SD (Q3 [4.52], Q4 [3.66] decreased by 0.86). Considering this, students paid more attention to the facial expressions of remote students than of lecturers. According to Redfern and Naughton (2012), facial expressions were an important visual cue for expressing emotion, agreement and understanding in online environments. Thus, students might deepen a sense of togetherness with the counterpart and be eager for building relationships each other, rather than the experts.

Answers to Q8 on the realistic feeling of the lecture similarly showed significant differences,

which agree with the preceding study assessing image quality in distance learning. Q9 asked about the sense of being in the same room with the remote participants. The answers for this question, again, found a significant difference between SD and HD. The same-room feeling is considered to be created by the special feature of HM. The manifestation of a significant difference in the answers to the question clarified that image quality influences the students' sense of being in the same room.

Q10 referred to the overall assessment of the HM environment. For this question, the difference between SD and HD was not significant; however, the gap between the average score was just 0.82 (Q1–Q9 of average 2.68). This fact suggests that image quality is not the sole contributing factor in the overall assessment of the HM system. Further examination is required on this matter.

7. Conclusion

In this paper, distance learning sessions with HM connecting three locations in Tsukuba, Nara, and Kumamoto were conducted with SD and HD to explore the possibility of HM connecting three locations as well as to compare SD and HD. As for HM connecting three locations, the practices with SD and HD were conducted without any problems. With HD, the image transmission bandwidth was at least 4 Mbps, and therefore, the wide and stable network was required at each location. Mutual communications and learning activities were carried out among participants as a result of multipoint HM, which made the distance learning environment close to that of a normal classroom.

According to the questionnaire, the image quality was not the sole contributing factor in the overall assessment of HM. From the result of Q10, we believe HM to be an effective system for distance learning, regardless of its picture quality. However, it was found that the participants paid attention to the graphs, pictures, and the expression of the other students. According to their free submission, the letters, pictures, and the expressions of the other person are hard to recognize with the SD image quality. Thus, in the preparation of the background image, particular attention should be paid to the size of graphs and pictures and care should be taken regarding where the participants should stand in order to maximize the quality of distance learning.

In the future, the question of what kind of educational activities are feasible or concerning videoconferences, and learning effectiveness with the image quality and further educational merits in HM connecting multiple locations shall require further study. Also, the establishment of an environment in which it is easier to set up the three-location HM is necessary. We would like to further discuss the effects of the environments described here on learning.

References

- Imai, A., Yamashiro, S., Matsukawa, H., Yamada, M., Maesako, T., Shibao, M., Okuji, K., and Ihara, K. (2002). Pilot Study of HyperMirror System via the Internet in Elementary Schools along International Exchange between Japan and South Korea. *Transactions of Japanese Society for Information and Systems in Education*, 19(4), 261-266.
- Matsukawa, H., Imai, A., Shigeta, K., Okano, K., Kagehira, Y., Maesako, T., Utsumi, S., and Seki, Y. (2005). A Case of Distance Learning Using Hyper Mirror System Via Satellite Phone. *Japan Journal of Educational Technology*, 28, Suppl., 257-260.
- Morikawa, O. and Maesako, T. (1998). HyperMirror: Toward Pleasant-to-use Video Mediated Communication System, *Proceedings of the 1998 ACM conference on CSCW*, 149-158.
- Nakazawa, A., Okubayashi, T., Mori, H., Maesako, T., Morikawa, O., Nakao, M., Tomii, N., Kuroda, T., Sato, T., Kawasugi, T., & Hashimoto, G. (2009). Applying High-Definition "HyperMirror" to Distance Learning Utilizing "KIZUNA". *The 27th International Symposium on Space Technology and Science*, 2009-j-19, 1-6.
- Nishihara, I., Nakano, S., Nakashima, M., Aoki, K., and Kuroda, T. (2006). BS-7-10 The study of high-presence remote education system with HDTV (High Definition Tele Vision). *Proceedings of the Society Conference of IEICE*, 2006 Communication (2), S-41-S-42.
- Redfern, S. and Naughton, N. (2002). Collaborative Virtual Environments to Support Communication and Community in Internet-Based Distance Education, *Journal of Information Technology Education*, 1(3), 201-211.
- Shimizu, Y. and Shiroma, S. (1990). Evaluation of HDTV Closed Circuit System for Distance Education. *The Journal of the Institute of Television Engineers of Japan*, 44(12), 1717-1722.

Information Literacy Skills of Pre-service Teachers: A Case Study

William Ko-Wai TANG^{a*}, Morris Siu-Yung JONG^b

^a*The Open University of Hong Kong, Hong Kong*

^b*The Chinese University of Hong Kong, Hong Kong*

*wtang@ouhk.edu.hk

Abstract: This study aimed at evaluating the information literacy skills of 29 pre-service teachers. Information literacy skills include five essential areas: the ability to (1) identify the information needs; (2) select information sources; (3) locate information; (4) evaluate information; (5) synthesize information. These areas are essential life-long learning skills for pre-service teachers to cope with the rapid change in the information age. In the present research, information literacy skills were measured by questionnaire, multiple choice knowledge test and task-based information problem. The findings indicate that the majority of participants lacked information literacy skills. It is concluded that instructional support to foster pre-service teachers' information literacy skills is essential.

Keywords: Information literacy, teacher training, information skills

1. Introduction

In the 21st century, students use Internet to retrieve and use information for solving problems or completing their assignments (Kolikant, 2009). Students should know how to search, evaluate and organize information from the Internet, which are the essential life-long learning skills and key elements of information literacy. However, there is little attention in schools. Teachers assume students can develop the skills spontaneously (Walraven, 2008). In Hong Kong, only one university offers a credit course on Information Literacy. Researches have shown that all age groups have problems in solving information-based problems (Argelagos & Pifarre, 2012; Probert, 2008; Walraven, Brand-Gruwel & Boshuizen, 2008). Teachers should help their students to develop their information literacy skills. An information literate pre-service teacher can search and use effective learning and teaching resources. They can also help their students to gain information literacy skills. When pre-service teachers lack information literacy skills, they have no confidence to educate their students (Demiralay & Karadeniz, 2010). It is important for pre-service teachers to have information literacy skills. We investigated the current status of information literacy skills of pre-service teachers in a self-financed university in Hong Kong. It examined pre-service teachers' ability to: (1) identify the information needs; (2) select information sources from the Internet; (3) locate information from the Internet; (4) evaluate information from the Internet; and (5) synthesize information by using internet tools.

2. Review of the literature

2.1 *Defining information literacy*

The term information literacy was first introduced by Paul Zurkowski in 1974. It was not related to the education. The first and most widely cited definition of the information literacy in education was proposed by American Library Association (ALA):

“To be information literate, a person must be able to recognize when information is needed and have the ability to locate, evaluate and use effectively the needed information.” (ALA, 1989, n.p.).

Some professional organization like the Association of College and Research Libraries (ACRL), the Society of College, National and University Libraries (SCONUL), Australian New Zealand Institute for Information Literacy (ANZIIL) have developed the framework of information literacy for Higher Education. In regards to teacher training, the Education and Behavioral Science Section (EBSS) in the Association of College and Research Libraries has developed an information literacy framework for teacher education. Some frameworks were developed prior to the shocking rise of social media and online community (Mackey & Jacobson, 2011). It does not fully address the information knowledge required in this new Internet environment.

2.2 Assessment of information literacy

A number of information literacy assessment strategies have been developed based on the information literacy framework. Abdullan (2010) categorized the information literacy assessment data as perception data and evidence-based data. The perception based data are collected from the self-rated questionnaire while the evidence-based data are collected from the performance of specific tasks and tests. McCulley (2009) also pointed out the assessment approaches of information literacy. It included survey, knowledge tests and performance assessment.

Surveys measure how the respondents feel about their performance, rather than the actual performance of information literacy. It is a good method to assess the student confidence and perceptions of information literacy. OuYang (2007) developed an evaluation instrument of information problem solving skills on Internet resources for pre-service teachers. It included the developmental level and confidence level of pre-service teachers' information problem solving skills.

Knowledge tests include a list of questions for students to answer, which measure what students know. It provides baseline information about students' information literacy skills (McCulley, 2009). There are several standardized information literacy tests such as Tool for Real-time Assessment of Information Literacy (TRAILS) and Project Standardized Assessment of Information Literacy Skills (SAILS). In regards to teacher education, Beile (2009) developed the information literacy assessment scale for education, which is designed for teacher students. It included 22 multiple choice questions that reflect cognitive dimension of information literacy.

Performance assessments require students to integrate what they have learned, to think critically and to solve the problem (McCulley, 2009). Brand-Gruwel, Wopereis & Walraven (2009) designed an information task to the undergraduate students by using neutral topic, such as how to deal with food that is out of date. Argelagos & Pifarre (2011) developed 15 web-based information problem solving activities. It included technology, mathematics, social sciences and sciences. On each activity, some guided questions on each information literacy area were provided. For example, on the area "defining the problem", students were required to write down the specific information that you need to solve this problem.

3. Methodology

3.1 Data collection and data analysis

The study included a group of 29 final year pre-service teachers who were studying in the first author's institution. All participants were required to take a module "Information Technology for Teaching". Information literacy skills were assessed by using questionnaire, multiple choice skills test and information task on the first week of this module, which provide the comprehensive assessment of information literacy.

Questionnaire is the most popular method to assess the information literacy skills (Walsh, 2009). The purpose of the questionnaire was to understand the perception on the information literacy skills of pre-service teachers. The questionnaire items were adopted by OuYang(2007) 's instrument for measuring information problem solving skills for pre-service teachers . It consisted of 28 likert-type questions and it is mapped to the five essential abilities (identify information needs, select information sources, locate information, evaluate information and synthesize information).

The questionnaire did not really assess pre-service teachers' actual performance. In order to check their actual performance, the researcher provided multiple choice skills test and information task

to all participants. The purpose of the multiple choice skills test was to assess the ability in selecting information sources, locating and evaluating information. It consisted of 19 multiple choice questions. The multiple choice items were revised based on Beile (2009)'s Test of Information Literacy for Education and Neely (2006)'s assessment items. Information task provided the most comprehensive measures of their actual performance. The participants required to solve specific information problem with several guided sub-questions.

4. Results and discussions

4.1 Questionnaire

We used a set of 28 items to understand the perception on the information literacy skills of pre-service teachers. The findings of the questionnaire were similar to OuYang's (2007) results. In general, participants had confidence in using information to solve problem, but they lacked confidence in some technical issues. For example, the use of online database and the ways of managing the data. Table 1 and 2 show the lowest and highest score items on each area respectively.

Table 1: Questionnaire – low score items.

Area	Item	Mean	SD
Identify the information needs	I am able to handle the requirements of the assignment or problem.	3.34	0.769
Select information source	I understand how to use online database	3.45	0.686
Locate information	I understand how to revise the search results	3.31	0.930
Evaluate information	I am able to evaluate the quality of information	3.24	0.872
Synthesize information	I am able to manage the data effectively	3.07	0.923

Table 2: Questionnaire – high score items.

Area	Item	Mean	SD
Identify the information needs	I know the required information to solve the problem	3.73	0.782
Select information source	I understand how to select the best information source to solve the problem	3.59	0.825
Locate information	I am able to use appropriate keywords on my search statement	3.72	0.649
Evaluate information	I am able to evaluate the reliability of data	3.55	0.948
Synthesize information	I am able to summarize information obtained from the Internet.	3.86	0.875

4.2 Multiple Choice Skills Test

We used 18 multiple choice questions to assess the ability in selecting information sources, locating and evaluating information. Table 3 shows the correct percentage of each question. According to table 3, more than half of the participants got a correct answer on six items (Q4, Q9, Q11, Q12, Q15 and Q17) only. The highest three items were "check accuracy of webpage" (82.76%), "URL meaning" (72.41%) and "Use of keywords" (65.52%). The lowest three items were "Determine the best information source" (13.79%), "Use of truncation" (17.24%) and "select appropriate operators" (20.69%). On the other hand, the correct percentages of all items on the area of selecting information source were below 50%. On the area of locating information, participants were familiar with the keywords setting but they did not know how to revise the search results. Multiple choice skills test indicated that they were lack of knowledge in using advanced search and operators. It may affect their performance on revising search results. In addition, the results showed that there was a contradiction between perception and actual skills on the item "determine best information source". They believed that they could select the best information source on questionnaire but they could not determine the best information source on the multiple choice skills test.

Table 3: Results – Multiple Choice Skills Test.

Area	Item	Correct %
Select information source	Q1: Use of information source (find a good journal)	34.48%
	Q2: Use of specific journal database (topic in ERIC)	27.59%
	Q3: Determine best information source (get brief information)	13.79%
Locate information	Q4: Use of keywords (best set of terms for specific question)	65.52%
	Q5: Advanced search (Use of advanced search)	41.38%
	Q6: Use of operator (1) (Select appropriate operators)	20.69%
	Q7: Use of operator (2) (Meaning of asterisk*)	41.38%
	Q8: Use of operator (3) (Use of truncation)	17.24%
	Q9: Search strategy (1) (best way to find related article)	62.07%
	Q10: Search strategy (2) (revised strategy to retrieve more results)	48.28%
	Q11: Search strategy (3) (retrieve fewer results)	55.17%
	Evaluate information	Q12: Website evaluation (1) (Evaluation criteria)
Q13: Website evaluation (2) (Identify objective information)		37.93%
Q14: Website evaluation (3) (Identify currency information)		44.83%
Q15: Website evaluation (4) (URL meaning)		72.41%
Q16: Website evaluation (5) (Identify reliability information)		31.03%
Q17: Website evaluation (6) (check accuracy of webpage)		82.76%
Q18: Website evaluation (7) (check authority of webpage)		44.83%

4.3 Information Task

In order to understand the actual performance, we used information task in this research. We adopted Brand-Gruwel's (2009) information problem – “How must we deal with perishability of food? Can we consume food that is out of date? Or must we rely on our senses?” and ten guided sub-questions were asked.

We analyzed the performance of the participants on all sub-questions by using rubrics. This research adopted Diller & Phelps's (2008) categorization of the performance in information literacy. It included Emerging (1 mark - limited recognition of the skills), Developing (3 marks - demonstrate appropriate skills) and Integrating (5 marks - demonstrate full understanding of the skills). In order to improve the inter-scorer reliability, two markers were employed to mark the same script. The reliability coefficients of all items were higher than 0.85. Table 4 shows the assessment items and descriptive statistics on each item. It ranged from 1.31 to 2.07. Results indicated that participants demonstrated limited information literacy skills. Section 4.3.1 to 4.3.5 discuss the performance on each area and compare the results between information task and questionnaire.

Table 4: Information task – descriptive statistics

Area	Assessment items	Mean	SD
Identify the information needs	Identify information needs	2.00	0.627
Select information sources	Information source and its contribution	2.00	0.916
	Best information source with reasons	1.74	0.545
Locate information	Use of keywords	1.90	0.632
	Use of search statements	1.47	0.581
Evaluation information	Use of website evaluation criteria	1.50	0.641
Synthesize information	Use of tools to manage information	1.72	0.493
	Ability to synthesize data	1.31	0.660

4.3.1 Identify the information needs

The research found that pre-service teachers were not able to identify the information needs. Low ability pre-service teachers responded “Ingredient of food”, “food” (participant 21) whereas high ability pre-service teachers responded “We need the information of the usage of perishable food and how to identify whether the food is out-of-date or not” (participant 15). In fact, the low-ability participants were not able to solve the information problem by using this information needs. There was a contradiction between information task and questionnaire. They believed that they knew the required information to solve the problem but they could not identify the information needs.

4.3.2 Select information sources

The pre-service teachers listed a limited number of information sources. 16 participants (or 55.17%) listed “relevant websites” as information sources. Only 8 participants (or 27.59%) mentioned journal as one of the information sources.

In regards to the number of information sources that they could provide, the average number of information sources was 1.41. The majority of participants (51.7%) were able to write down one information sources only. The maximum number of information sources that they could provide was 4, only 6.9% of participants listed it.

On the assessment item “best information sources with reasons”, 24.1 % of participants were not able to provide the best information sources. For those who were able to provide the best information sources, 27.59% of participants believed that the best information sources was websites (It included general websites, official website or government website) and only 17.24% of participants believed that journal provide the best information to solve problem. It matched with the questionnaire data. However, they did not provide any reasons to explain it.

4.3.3 Locate information

On the assessment item “use of keywords”, 41.38% of participants were able to write down one or two keywords only and 45% of participants were able to write down more than two keywords. However, many of them used the original wordings on the information problem. 37.93% of participants used “perishability” as one of the keywords. Only two participants (or 6.89%) were able to provide relevant keywords other than the wordings on original problem. For example, participant 15 provided a series of keywords like “food poisoning, food spoilage, bacteria, fungous spore, decay of food, food preservation”. Refer to the above results, it did not match the results on questionnaire. They believed that they were able to create appropriate keywords but they used the original words only.

On the assessment item “use of search statement”, 41.4% of participants were able to use single search statement and 31.0% of participants were able to provide more than one search statements. Similar to the assessment item “use of keywords”, they were able to provide some simple statement from the original problem. For example, participant 22 provided the statement “How to deal with perishable food?” and participant 26 provided the statement “Perishability of food”. In fact, only 4 participants (or 13.79%) were able to use search operators on the search statement.

4.3.4 Evaluate information

Over half of the participants were able to use “authority” (16 participants or 55.17%) and “currency” (15 participants or 51.73%) as website evaluation criteria. Some of them used “objectivity” (11 participants or 37.93%), “reliability” (8 participants or 27.59%) and “coverage”(5 participants or 17.24%). However, some participants used wrong evaluation criteria, like “Ranking”, “Readable”, “Easy to search” and “Common Sense”.

4.3.5 Synthesize information

The majority of participants used Microsoft Word (14 participants or 48.28%) and browser bookmarking services (12 participants or 41.38%) to manage information. It was not a good strategy to

manage information and it matched with the results on the questionnaire. They knew how to summarize information but they were not able to manage the data effectively.

On the assessment item “Ability to synthesize data”, 31.03% of participants were able to respond to the information problem. Some participants were able to respond to each sub-question by using table or concept map, but some participants used one or two sentences to synthesize information. For example, participant 18 used “Expired food --> high germ production (from relevant biologist) --> Harmful --> Do not eat!!!”.

5. Conclusion

This paper reports the information literacy skills of pre-service teachers in the first author’s institution. By using questionnaire, multiple choice skills tests and information tasks, it investigated the perception and performance of information literacy skills of pre-service teachers. Results showed that participants had confidence in their information literacy skills but they had limited knowledge of information literacy. However, the relatively small sample size in a particular program limits the generalizability of the findings to other pre-service teachers who are studying education programmes in other institutions. Further studies can systematically investigate how to foster pre-service teachers’ information literacy skills in teacher training curriculum.

References

- Abdullah, S. (2010). Measuring the outcomes of information literacy: Perception vs evidence-based data. *The International Information and Library Review*, 42, 98-104.
- American Library Association. (1989). *Presidential Committee on Information Literacy, Final report*. Chicago: Author. Retrieved from <http://www.ala.org/ala/acrl/acrlpubs/whitepapers/presidential.html>
- Argelagos, E., & Pifarre, M. (2012). Improving information problem solving skills in secondary education through embedded instruction. *Computers in human behavior*, 28, 515-526.
- Beile, P. (2009). *Measuring information literacy skills in education: Development and validation of a standards-based assessment scale*. Saarbrücken: VDM Verlag Dr. Müller Aktiengesellschaft & Co. KG.
- Brand-Gruwel, S., Wopereis, I., & Walraven, A. (2009). A descriptive model of information problem solving while using internet. *Computers & Education*, 52, 1207-1217.
- Demiralay, R., & Karadeniz, S. (2010). The Effect of Use of Information and Communication Technologies on Elementary Student Teachers’ Perceived Information Literacy Self-Efficacy. *Educational Sciences: Theory And Practice*, 10(2), 841-851.
- Diller, K. R., & Phelps, S. F. (2008). Learning outcomes, portfolios, and rubrics, oh my! authentic assessment of an information literacy program, *portal: Libraries and the Academy*, 8(1), 75-89.
- Kolikant, Y. B. D. (2009). Students’ perceptions of the appropriateness and usefulness of the Internet for schoolwork and the value of school. *Journal of Educational Computing Research*, 41, 407-429.
- Mackey, T. P., & Jacobson, T.E. (2011). Reframing information literacy as a metaliteracy. *College and research libraries*, 72(1), 62-78.
- Mcculley, C. (2009). Mixing and matching: assessing information literacy. *Communications in Information Literacy*, 3, 171-180.
- Neely, T. Y. (2006). *Information literacy assessment: Standards-based tools and assignments*. Chicago: American Library Association.
- OuYang, Y. (2007). Factors impacting the Information Problem-Solving Skills of Internet resources on pre-service teachers. *Educational Review*, 28, 225-249.
- Probert, E. (2008). Information literacy skills: Teacher understandings and practice. *Computers and Education*, 53(1), 24-33.
- Walraven, A. (2008). *Becoming a critical websearcher: Effects of instruction to foster transfer*. Doctoral Dissertation. Netherlands: Open University of the Netherlands.
- Walraven, A., Brand-Gruwel, S., & Boshuizen, H. P. A. (2008). Information-problem solving: A review of problems students encounter and instructional solutions. *Computers in Human Behavior*, 24, 623-648.
- Walsh, A. (2009). Information literacy assessment: Where do we start? *Journal of Librarianship and Information Science*, 41(1), 19-28.

Interactive Whiteboards in Classrooms: Debates, Issues, and Impeding Factors

Mas Nida MD KHAMبارI^{a*}, Dawnene HASSETT^b, Michael THOMAS^c & Su Luan WONG^d
^{ad}Universiti Putra Malaysia, Malaysia
^bUniversity of Wisconsin-Madison, USA
^cUniversity of North Carolina-Charlotte, USA
*nidakhambari@gmail.com

Abstract: This paper compiles the review of the literatures revolving around the studies on the use of interactive whiteboards in schools. It criticizes and summarizes the current debates, issues, and impeding factors found in empirical studies. Through various articles related to the studies about technology and interactive whiteboard in schools dated from 1986 to 2014, the findings of this critical review suggest that teacher-centered versus student-centered mode of instruction is one of the most debated issues highlighted across studies. Unfortunately, teachers are being continuously blamed on the way they use the interactive whiteboards. The method technology is introduced to the teachers, teachers' willingness and negative perception on technology initiatives, trainings, and technical problems, are among other issues and impeding factors that hampers the interactive whiteboards implementation in schools. This paper also identifies the gap in the literature and calls for future research in areas such as the role of context and school community involvement in the diffusion process of interactive whiteboard technology.

Keywords: interactive whiteboard technology, teacher-centered, student-centered, issues, problems

1. Background

The interactive whiteboard is deemed as the most advance technology at present. A report by the SMART Technologies Inc. suggests the benefits of the interactive whiteboards on students when used by teachers: "Educators can use digital resources while maintaining dynamic interaction with the entire class, provide computer-based learning without isolating students and encourage a higher level of student interaction in both teacher-directed and group-based exchanges." (2006, p. 5).

As its name implies, interactive whiteboards have the affordances to be used in an *interactive* manner and could support *interactive* learning (Mildenhall, Swan, Northcote, & Marshall, 2008). Based on the literature, it is found that interactive whiteboards have been used in schools for orientating lesson, orchestrating interactive teaching-learning activities (Gillen, Littleton, Twiner, Staarman & Mercer, 2008; Coyle, Yañez & Verdú, 2010), creating and saving lesson resources (Hall & Chamblee, 2009; Littleton, Twiner & Gillen, 2010), and linking them with other technological resources (Armstrong, Barnes, & Sutherland et al., 2005). Empirical studies showed that in many ways, these aforementioned types of usage underpin teachers' manner in integrating interactive whiteboards in their teaching.

2. Research Purpose, Questions, and Methods

The purpose of this paper is to provide evidences from empirical studies that have been carried out on the interactive whiteboards in classrooms. Because the interactive whiteboard technology have become more ubiquitous and its endowment initiatives in schools are increasing over the past decade, this paper summarizes the key issues arising from these initiatives as a means to provide insights into the implementation of such technology. The questions that drive the review of the literature are: (1) What

is/are the current trends or debate(s) in literature on the interactive whiteboard initiatives? and (2) What are the issues and impeding factors toward interactive whiteboards implementation in schools? The review of the literature involves various research studies of the related field dated from 1986 to 2014. Such collections of research studies are gathered through the researchers' comprehensive search on articles based on the questions that motivate this study.

3. Discussion

3.1. Teacher-centered versus Student-centered Debates in Interactive Whiteboard Classrooms

The question of whether the mode of lesson delivery should be teacher-centered or student-centered has become a debated issue among scholars. With the interactive affordances of the digital whiteboard, teachers are expected to make their instructions more student-centered rather than teacher centered (Taylor, Harlow, & Forret, 2010; Kershner, Mercer, & Warwick et al., 2010; Northcote et al., 2010; Şad & Özhan; 2012). Other studies emphasize the importance of student authority in maneuvering their own learning (Kennewell, Tanner, & Beauchamp, 2008; Harlow, Cowie, & Heazlewood, 2010).

Beauchamp (2004) found in his study that most of the time, teachers retain control of the interactive whiteboards, giving little to no chance for students to explore and navigate the technology or to perform tasks on the board. Although the mode of instruction may not be student-centered, this step may result in the students being able to learn how to use the technology by observing teachers' use. In contrary, Northcote et al. (2010) argue that too much control of interactive whiteboards by teachers does not only limited students' opportunity to use the board, but it also leads to a teacher-controlled classroom.

Similarly, Kennewell et al. (2008) point out that the implementation of interactive whiteboards might be regarded as a backward step towards teacher-centered learning. They argue that learning is becoming more teacher-centered when teachers enforced a more traditional approach in the use of interactive whiteboards. This is consistent in both studies conducted by Kershner et al. (2010) who analyzed students' semi-autonomous use of interactive whiteboards, and Zevenbergen and Lerman (2010) who explored the various approaches used by teachers for mathematics teaching in interactive whiteboard environment.

Miller, Glover, and Averis (2005) recommend maximizing the number of students working on the interactive whiteboards for a student-centered instruction. This can help students develop confidence in using the technology as well as influencing their peers to participate in classroom activities centered on the board. However, amidst the debates of teacher-centered versus student centered instruction, there is a gap on how much we know about teachers' goals. Such gap lacks in addressing teachers concerns when using the interactive whiteboard, which may include their specific learning goals that must be achieved during a specific time frame. Can they possibly achieve their goals by allowing students to use interactive whiteboards in an unlimited manner hoping that students can be more participative?

A recognized pattern emerging from the literature portrays teachers as being repeatedly blamed for the manner in which they use the interactive whiteboards in classrooms. For instance, overuse of interactive whiteboards is said to promote teacher-centeredness (Northcote et al., 2010). Studies have reported that the use of interactive whiteboards has resulted in teachers becoming more active while students are becoming more passive (Holmes, 2009). Some teachers use the interactive whiteboards as a form of supported didactic role (Miller et al., 2005) hence the affordances of interactive whiteboards to support interactive teaching are often overlooked (Holmes, 2009; Northcote et al., 2010). It seems that everything that the teachers do on the use of interactive whiteboards is not seen positively.

de Koster, Volman, and Kuiper (2013) attempt to define the difference between a teacher-centered or student-centered instruction based on the person in charge of the interactive whiteboard. They claim that a lesson is teacher-centered when knowledge transmission was done by the teacher and a lesson is student-centered when content sharing occurs between teachers and students. Nevertheless, the classroom's interactivity should not be judged based on the basis of who operates the board alone. They

also call for realistic expectations among the technology imposers and teachers when looking at how the interactive whiteboards are used in classrooms.

It is really delicate for teachers to strike a balance to juggle their several obligations and paying attention to students' needs while at the same time thinking of creative ways to maximize the use of interactive whiteboards. The current literature points to the importance of letting students to have more control of the interactive whiteboard with the idea that this could increase their participation in classroom activities and engagement in lessons (Miller & Glover, 2002; BECTA, 2003; Kennewell et al., 2008; Wood & Ashfield, 2008; Harlow et al., 2010). However, very little is known about how this idea could be translated as a teacher-centered or student-centered instruction, and the ecological factors that foregrounds the mode of such instructions found across studies.

3.2. Issues and Impeding Factors

For every innovation that tries to make its way into a system, there exist several processes that may support or impede its use and implementation. Rogers (2003) calls this as the innovation-decision process where innovations can be rejected at any time during or after the adoption process. According to him, the innovation decision could be made either by an individual, collectively, or authoritatively by the leader of a social system. Across studies, there are evidence on how such decisions have affected the adoption process and its continuity.

Glover and Miller (2002) suggest that leadership type affects the implementation of interactive whiteboards in schools. Teachers in the schools where Glover and Miller (2002) conducted their study were not keen to integrate technology into their classrooms because they were fearful that this innovation would become just another "educational gimmick" (p. 6). However, when the faculty heads started to implement the interactive whiteboards and demonstrated ease of use, the teachers started to gain confidence in the technology. This phenomenon of a domino effect where one movement from the faculty heads had sparked movements to other teachers. The smooth implementation and use of interactive whiteboards demonstrated by the faculty heads were visible to the teachers, resulting in positive reactions.

On the contrary, in another school in the same study, the head teacher made an authoritative innovation-decision whereby he pursued a policy of forcing staff members to use the new technology. Interactive whiteboards were installed in classrooms without the teachers' knowledge. The head teacher contended that this step would leave his teachers with no choice but to use the interactive whiteboard. Nevertheless, this approach raises issues of disadvantage, especially when teachers were not ready or willing to use the interactive whiteboard in their teaching. This may lead to the underuse of technology and is seen as a waste especially when the installation has cost a massive amount of investment (Cuban, 2001).

Cuban (1986) listed several factors that hinder teachers' use of technology including unwillingness to change and invest time to learn that leads to teachers' failure to recognize its affordances, unfamiliarity to technology, fear of trying new innovations, and frustration with past experiences. Teachers' deep-seated beliefs in their current pedagogical stance, and flawed implementation, also contributed to the under-utilization of technology in schools. These are the underlying factors to the processes that impede the use of interactive whiteboards in schools.

In contrast, Northcote et al. (2010) argue that overuse of technology could lead could affect the locus of control in classroom activities, thus lead to a teacher-centered instruction. Accordingly, this leads to the impediment of teacher-student partnership during lessons and shared authority in interactive whiteboards usage. They add that such impediment diminishes the opportunity for students to interact directly with interactive whiteboards.

Training is advocated as one of the most important elements in the process of technology diffusion and implementation as a means to prepare teachers for the transition of a classroom without technology to one with an interactive whiteboard (Beauchamp, 2004). According to Miller and Glover (2002), insufficient training and limited development of interactive whiteboard teaching skills are key problems to the successful use of interactive whiteboards. Teachers also need a certain amount of time to

familiarize themselves with technology (Md. Khambari, Moses, & Wong, 2009). Moreover, a longer time is needed to prepare lessons that use interactive whiteboards.

Buckingham (2006) argues that technology should not be assumed as a neutral means for everyone. Rather, people should be educated about the technology and how to effectively use it. Therefore, training is important as it provides teachers with the appropriate knowledge before simply putting the technology in their hands and letting them decide what they could do with it. Although teachers' training for interactive whiteboards is widely mentioned in the literature, to date, there was no mention of whether teachers are satisfactorily trained to use interactive whiteboards in an interactive manner.

Wood and Ashfield (2009) also emphasize that teachers must have control over their own lesson by choosing and deciding on the appropriate software. Now that there is an increase in the numbers of ready-made teaching resources, teachers have unconsciously become slaves to the software instead. If teachers are blindly using the commercial software and later found that the software could not help them achieve their objectives, this phenomenon may frustrates them, leads to the rejection of the interactive whiteboard (Rogers, 2003), and disregard such technology altogether from their pedagogy.

Şad and Özhan (2012) found that technical glitches such as electricity outage or de-alignment of pen, and natural distraction such as sunlight glare on the screen of the interactive whiteboard made the students upset and interrupts the use of the technology. Ju and Ya (2014) suggest that the digital feature of the interactive whiteboard offers a more hygienic classroom as compared to the dusty blackboard the teachers in their study used to use, and its ability to display multimedia has improved students' attention, participation, and digital literacy. However, they found that the touch sensitive feature was a limitation because it only allows one user to use it at a time.

Beauchamp's (2004) study found that student teachers predominantly perceive interactive whiteboards as an important feature of their future teaching. Experienced teachers, however, needed more convincing before they are ready to use it. Similarly, Cuthell (2005) laments that the number of schools that have changed their praxis is very small. In many cases, when a new policy is being formulated, teachers who are the implementers at the grass root level are seldom consulted. What can be learned from these studies is that a needs analysis is needed prior to the diffusion of an innovation. As such, before innovations are to be permanently placed in the classroom, information needs to be gathered on whether or not teachers prefer to have the interactive whiteboards in their classroom.

When interactive whiteboards are put into implementation in schools, teachers are expected to use the technology in their teaching. Zevenbergen and Lerman (2008) found that teachers fear of not fulfilling their professional responsibilities if they did not use the interactive whiteboards in teaching. This example provides evidence where teachers are caught in the middle between their personal pedagogy that they have been comfortable with, and the professional responsibility to keep themselves and students in tap with the latest advancements in education. Having to make a delicate decision of whether to use or not to use the technology is an issue yet to be explored in future studies.

4. Concluding Remarks

The literature to date converges on the advantages of interactive whiteboards as a tool that opens up various possibilities and teaching pedagogies. Unfortunately, there are also emerging trends of teacher blaming whereby they are criticized for the manner in which they use interactive whiteboards in classrooms. However, there is no clear definition of how an instruction with the interactive whiteboard should be regarded as student-centered or teacher-centered. Additionally, nothing about the amount of control of the interactive whiteboard by the teachers and students are discussed in the literature to clearly define the mode of instruction. Among the key issues identified in the literature highlight the importance of teachers' readiness to integrate the interactive whiteboard technology in their classroom, as well as education authority's role in diffusing new innovation to teachers. Conflict of interests between teachers (on their pedagogy) and technology imposers (on how they visualize teachers to use the interactive whiteboards) could lead to the underuse of the technology. Perhaps the teacher-centered or student-

centered debates, and teacher blaming issues, do not even make sense if areas such as teachers' interest and pedagogy as well as their nature of work, are explored and understood.

Rogers (2003) has warned, "many aspects of diffusion cannot be explained by just individual behavior" (p. 23). He says, among others, that the overall system should be studied to draw its several influences on its members. Based on his piece of advice, it became more evident that the literature on the interactive whiteboard use in schools lags behind in a number of areas. For instance, the nature of the school system such as its administrative system, its social, cultural, and historical practices, its climate and rules; the perceived attributes of the interactive whiteboard, and the type of the community the interactive whiteboard is diffused to, are the areas that are still remain barely touched in the literature. Additionally, nothing about the function of the school was mentioned in the literature on technology in the education system. This paper calls for future studies to take on the quantitative or qualitative nature of research to explore with more depth on the context and the social system in which interactive whiteboards are situated.

References

- Armstrong, V., Barnes, S., Sutherland, R., Curran, S., Mills, S. & Thompson, I. (2005). Collaborative research methodology for investigating teaching and learning: the use of interactive whiteboard technology. *Educational Review*, 57(4), pp. 457-469. doi: 10.1080/00131910500279551.
- Beauchamp, G. (2004). Teacher use of the interactive whiteboard in primary schools: towards an effective transition framework. *Technology, Pedagogy and Education*, 13(3), pp. 327-348. doi:10.1080/14759390400200186.
- BECTA (2003). *Getting the most from your interactive whiteboard. A guide for primary schools*. Retrieved from: <http://www.dit.ie/lttc/media/ditlttc/documents/gettingthemost.pdf>
- Buckingham, D. (2006). Defining digital literacy: what do young people need to know about digital media? *Digital Kompetanse*, 4(1), pp. 263-276.
- Cuban, L. (1986). *Teachers and machines: The classroom use of technology since 1920*. New York: Teachers College Press.
- Cuban, L. (2001). *Oversold and Underused: Reforming Schools Through Technology, 1980- 2000*. Cambridge MA: Harvard University Press.
- Cuthell, J. P. (2005). Seeing the meaning: the impact of interactive whiteboards on teaching and learning. In *Proceedings of 8th World Conference on Computing in Education 2005*. Stellenbosch: South Africa
- de Koster, S. Volman, M. & Kuiper, E. (2013). Interactivity with the interactive whiteboard in traditional and innovative primary schools: An exploratory study. *Australasian Journal of Educational Technology*, 29(4), pp. 480-495.
- Department for Education and Employment (1998). *The National Literacy Strategy: a framework for teaching*. London: DfEE
- Gillen, J., Littleton, K., Twiner, A., Staarman, J. K. & Mercer, N. (2008). Using the interactive whiteboard to resource continuity and support multimodal teaching in a primary science classroom. *Journal of Computer Assisted Learning*, 24(4), pp. 348-358. doi: 10.1111/j.1365-2729.2007.00269.x
- Glover, D. & Miller, D. (2002). The introduction of interactive whiteboards into schools in the United Kingdom: leaders, led and the management of pedagogic and technological change. *International Journal for Leadership in Learning*, 6(24), pp. 112-128.
- Glover, D. & Miller, D. (2002). The introduction of interactive whiteboards into schools in the United Kingdom: leaders, led and the management of pedagogic and technological change. *International Journal for Leadership in Learning*, 6(24), pp. 112-128.
- Hall, J. & Chamblee, G. (2009). Teacher perception of interactive whiteboards: a comparison of users and future-users in high school over a one year period. In K. McFerrin, R. Weber, R. Carlsen & D. Anna (Eds.), *Proceedings of Society for Information Technology and Teacher Education International Conference 2009* (pp. 1857-1862). Chesapeake, VA: AACE.

- Harlow, A., Cowie, B., & Heazlewood, M. (2010). Keeping in touch with learning: the use of an interactive whiteboard in the junior school. *Technology, Pedagogy and Education*, 9(2), 237-243. doi: 10.1080/1475939X.2010.491234
- Holmes, K. (2009). Planning to teach with digital tools: Introducing the interactive whiteboard to pre-service secondary mathematics teachers. *Australasian Journal of Educational Technology*, 25(3), pp. 351-365.
- Ju, Y. Y. & Ya, W. T. (2014). Perceptions of elementary school teachers and students using interactive whiteboards in English teaching and learning. *Journal of Interactive Learning Research*, 25(1), pp. 125-154.
- Kennewell, S. & Higgins, S. (2007). Introduction. *Learning, Media and Technology*, 32(3), pp. 207-212. doi: 10.1080/17439880701511024
- Kennewell, S., Tanner, H. & Beauchamp, G. (2008). Analysing the use of interactive technology to implement interactive teaching. *Journal of Computer Assisted Learning*, 24(1), pp. 61-73.
- Kershner, R., Mercer, N., Warwick, P. & Staarman, J. K. (2010). Can the interactive whiteboard support collaborative communication and thinking in classroom science activities? *Computer-Supported Collaborative Learning*, 5(4), pp. 359-383. doi: 10.1007/s11412-010-9096-2
- Littleton, K., Twiner, A. & Gillen, J. (2010). Instruction as orchestration: multimodal connection building with the interactive whiteboard. *Pedagogies: An International Journal*, 5(2), pp. 130-141. doi: 10.1080/15544801003611193
- Md. Khambari, M. N., Moses, P. & Wong, S. L. (2009). Laptop ownership and use among educators: Reflections from school teachers in Malaysia. *International Journal of Instruction*, 2(2), pp. 47-72.
- Mildenhall, P., Swan, P., Northcote, M. & Marshall, L. (2008). Virtual manipulatives on the interactive whiteboard: a preliminary investigation. *Australian Primary Mathematics Classroom*, 13(1), pp. 9-14.
- Miller, D., Glover, D. & Averis, D. (2005). Presentation and pedagogy: the effective use of interactive whiteboards in mathematics lesson. In D. Hewitt & A. Noyes. (Eds.), *Proceedings of the 6th British Congress of Mathematics Education*, 25(1), pp. 105-112. London: British Society for Research into Learning Mathematics.
- Northcote, M., Mildenhall, P., Marshall, L. & Swan, P. (2010). Interactive whiteboards: Interactive or just whiteboards? *Australasian Journal of Educational Technology*, 26(Special issue, 4), pp. 494-510.
- Rogers, E. M. (2003). *Diffusions of Innovation*. (5th ed.). New York: Free Press.
- Şad, S. N. & Özhan, U. (2012). Honeymoon with IWBs: A qualitative insight in primary students' views on instruction with interactive whiteboard. *Computers & Education*, 59(4), pp. 1184-1191. doi:10.1016/j.compedu.2012.05.010
- Slay, H., Siebörger, I. & Williams, C. H. (2008) Interactive whiteboards: real beauty or just "lipstick"? *Computers & Education*, 51(3), pp. 1321-1341. <http://dx.doi.org/10.1016/j.compedu.2007.12.006>
- SMART Technologies Inc. (2006, March). *Interactive whiteboards and learning: improving student learning outcomes and streamlining lesson planning*. Retrieved from http://downloads01.smarttech.com/media/research/whitepapers/int_whiteboard_research_whitepaper_update.pdf
- Taylor, M., Harlow, A. & Forret, M. (2010) Using a computer programming environment and an interactive whiteboard to investigate some mathematical thinking. In R. A. Tarmizi & A. F. Mohd. Ayub (Eds.) *Procedia: Social and Behavioral Sciences of the International Conference on Mathematics Education Research 2010 (ICMER 2010), Special Issue (8)*, pp. 561-570. doi:10.1016/j.sbspro.2010.12.078
- Wood, R. & Ashfield, J. (2008). The use of interactive whiteboard for creative teaching and learning in literacy and mathematics: a case study. *British Journal of Educational Technology*, 39(1), pp. 84-96. <http://dx.doi.org/10.1111/j.1467-8535.2007.00703.x>
- Zevenbergen, R & Lerman, S. (2008). Learning environments using interactive whiteboards: new learning spaces or reproduction of old technologies? *Mathematics Education Research Journal*, 20(1), pp. 108-126.

Learning Design Framework for Constructive Strategic Alignment with Visualizations

Gargi BANERJEE*, Mrinal PATWARDHAN & Sahana MURTHY
*Interdisciplinary Program in Educational Technology,
Indian Institute of Technology Bombay, India*
*gargi@it.iitb.ac.in

Abstract: Prior research on integrating computer-based visualization tool in teaching has shown that the use of constructivist strategies has led to positive learning outcome. Yet multiple surveys report that instructors face difficulty in integrating visualizations in their teaching. A probable cause is that instructors, on their own, are unable to achieve effective alignment between the instructional strategy used with visualization and their instructional objective. Currently no guidelines exist for instructors for attaining such alignment while teaching with technological tools like visualizations. To address this problem, we propose the Customized Visualization Integration (CVI) framework based on outcomes-based teaching approach that targets ‘constructive strategic alignment’ i.e. alignment between student-centered instructional strategies and instructional objectives with the visualization. CVI provides instructors with ‘easy-to-use’ guidelines that can be combined to create learning designs (LDs) customized to their set of instructional objectives with visualization. Furthermore, it provides LDs customized to individual objectives based on these guidelines. In current paper, we also present empirical validation for a subset of the proposed guidelines through a field experiment with 144 engineering under-graduates.

Keywords: Framework, visualization, constructive strategic alignment, learning design.

1. Introduction

Computer-based visualizations involve “the use of computer supported, interactive, visual representations of data to amplify cognition” (Tory & Moller, 2004) like educational animations and simulations. These visualizations improve conceptual and procedural understanding and develop reasoning and prediction skills (Rutten et.al, 2012). However, their learning effectiveness is dependent on the instructional method used (Bratina et.al, 2002). Empirical studies show that use of constructivist strategies with visualizations like think-pair-share (McConnell, 1996) leads to improved learning outcome. Another important criterion is alignment between the strategy used and the instructional objectives (Boyle, 2012). There are several studies (Biggs, 1999; Cohen, 1987) emphasizing the importance of strategic alignment in teaching. Cohen (1987) cites multiple empirical studies that show significantly reduced learning outcome due to non-alignment between instructional strategy and objective. Thus, effective integration of visualization in teaching entails use of constructivist strategies aligned with the instructional objective i.e. constructive strategic alignment. But multiple surveys (Shaffer et.al, 2011) reveal that instructors face difficulty in integrating visualizations in their teaching. This difficulty occurs along two fronts – designing for constructive strategic alignment on their own (Conole et.al, 2004) and ensuring implementation fidelity for constructivist strategies (Ebert-May et.al, 2011). The existing solutions like learning designs (LDs) and learning taxonomies do not provide instructors with detailed guidelines on how to achieve this alignment with visualization. In fact, there is no prior study identifying instructional objectives with visualizations. Thus, a learning design framework with ‘easy-to-use’ guidelines for instructors to achieve strategic alignment for different objectives with visualization is needed. CVI (Customized Visualization Integration) is such a learning

design framework that provides instructors with guidelines and LDs to achieve strategic alignment with visualization. The contribution of this paper is the CVI framework and its three major components - i) Instructional objectives with visualization identified through an exploratory study with Science and Engineering instructors, ii) 'Easy-to-use' guidelines that instructors can use to create LDs aligned to objectives. iii) LDs mapped to individual objectives with visualization. We also validate the guidelines for four types of objectives with visualization, encompassing problem-solving and conceptual understanding through a controlled field experiment with 144 Electrical Engineering students.

2. Related Work

Multiple empirical studies report the benefits of using constructivist strategies with visualizations like think-pair-share (McConnell, 1996) across different instructional settings like lecture, laboratory and self-learning. But, instructors face problems in attaining constructive alignment with visualizations and maintaining implementation fidelity for the constructivist strategies. In this section we discuss a subset of learning taxonomies like Bloom's, SOLO taxonomy, Component Display Theory and Morrison's Extended Content Performance matrix among the many that exist. These taxonomies do not address strategic alignment for teaching with a technological tool like visualization. For example, Revised Bloom's taxonomy provides six cognitive levels of learning objectives to guide alignment between strategy and objective. In the 'Component Display Theory'(Merrill, 1983) instructors can choose strategy for a complete lesson based on three major factors – i) content type (Facts, Concepts, Procedures, Principles) and performance objectives expected from students (Remember, Use, Find) ii) type of primary and associated secondary presentation forms and iii) rules relating presentation forms to content performance matrix. Morrison et. al. (2010) also bases their work on a content-performance matrix where performance objective is restricted to Recall and Application and instructional strategies to four categories – Elaboration, Organizational, Integrative and Recall. However, none of these focus on teaching with visualization nor do they provide detailed implementation plan to instructors. The other problem of implementation fidelity refers to how well the strategy execution follows the defined procedure. Empirical studies (Ebert-May et.al, 2011) have found that majority of the faculty, who professed using constructivist strategies, in fact veered towards teacher-centered teaching in their lectures. To address this problem, learning designs (LDs) provide stepwise implementation plan to instructors. They help instructors execute pedagogically sound instructional activities mapped for different types of media and instructional setting (Mor & Brock, 2012). But they do not map instructional activities to specific instructional objectives with visualization. Thus, no guidelines currently exist for instructors on achieving constructive strategic alignment with visualization.

3. Solution Approach & Research Questions

The objective of the current study was to build the CVI framework to assist instructors in effectively integrating visualizations in their teaching. This framework takes as its input the instructor's choice of instructional objectives with visualization. It then identifies instructional strategy design components aligned to the chosen objectives. The term 'instructional strategy design components' refers to functional units within the strategy like raising cognitive conflict or students verbalizing their problem solving strategy. CVI outputs guidelines to achieve strategic with visualization as also LDs, mapped to particular objectives that specify stepwise execution plan to achieve the alignment.

The three research questions explored in the study were:

- RQ1: What categories of instructional objectives do instructors have while teaching with visualization? (Section 4.1)
- RQ2: What are the instructional strategy design components necessary to achieve alignment with each of the identified objectives with visualization? (Section 4.2)
- RQ3: What is the ecological validity of the mapping proposed by CVI framework between instructional objectives with visualization and instruction strategy used, for a chosen subset of objectives? (Section 5)

4. Formulating CVI (Customized Visualization Integration) Framework

The CVI framework was built in two consecutive phases with each phase having its own separate methodology. In phase 1, we identified instructional objectives with visualization through an exploratory study of semi-structured instructor interviews. In phase 2, we mapped these objectives with instructional strategy design components through analysis and synthesis of literature.

4.1 Identifying Instructional Objectives with visualization

We did a qualitative study by conducting semi-structured interviews with 61 instructors from multiple domains of science and engineering like Chemistry, Physics, Computer Science, Electrical. The instructors had teaching experience of 5-20 years and had used visualization in teaching. During the interviews, which ranged from 50-60 minutes, instructors were asked to show sample visualizations they had used and what their instructional objective was with that visualization. The interview responses were coded by two researchers through the open and axial coding stages (Corbin & Strauss, 2008) with an inter-rater agreement of unweighted Kappa 0.81. The interviews were interleaved with the open coding phase. Hence, questions asked in subsequent interviews were influenced by the open codes emerging from analysis of previous interviews. The open codes thus obtained for all the interviews were grouped into broader categories in the axial coding phase (Table 1). A total of 11 objective categories emerged which were of finer granularity than those proposed in existing learning taxonomies. In this paper we report a subset of four such objectives that were part of our validation experiment (Table 4).

Table 1: Sample coding of instructional objectives with visualization.

Interview response (verbatim)	Open Code	Axial Code
Observe the phenomenon & construct an explanation of conductor properties & fields	Frame the definition of a concept after observing the visualization	Derive, through logical reasoning, definition of a concept/relationship
Observe the visualization on sorted linked list & write a simple algorithm for it	Develop the logic of process execution with given input parameters & specified output, after observing visual demonstration of the process	between variables or algorithm of a process from observations made from the visualization
Observe the Brayton cycle visualization & draw the temperature-entropy diagram	Predict relationship between different variables while watching the visualization, before the concept is taught	

4.2 Identifying Instructional Strategy Design Components

In phase 2, the instructional objectives obtained were analyzed for their cognitive rigor and specific skills targeted, if any, like multiple representation or problem solving. We determined the cognitive rigor from the Cognitive Rigor (CR) matrix (Hess et.al, 2009) comprising of Bloom’s cognitive level and Webb’s depth of knowledge. We then analyzed and synthesized relevant literature to identify instructional strategy design components mapped to the objective categories. For example, for the objective of ‘Write/Draw alternate representations from the given visualization or vice-versa.’, we analyzed literature on teaching and learning of multiple representations as well as application of conceptual knowledge to identify design components relevant for the objective (Table 2). Based on this mapping, we framed guidelines for instructors on what design components to include in their learning designs to achieve strategic alignment (Table 2). We also created sample learning designs (LDs), mapped to individual objectives, that give stepwise implementation plan for attaining constructive strategic alignment (Fig. 1). We found the required design components for a particular objective can be operationalized through multiple constructivist strategies. Hence, CVI has taken a sample set of constructivist strategies like TPS-V (Think-Pair-Share with Visualization) to illustrate the execution of the recommended mappings (Fig. 1).

Table 2: Sample Instructional Strategy Design Components mapped to objectives with visualization.

Instructional Objective with Visualization	Necessary Instructional Strategy Design Components	Guidelines for strategic alignment
Write/Draw alternate representations from the given representation in the visualization or vice-versa.	i) ‘Dynamically link the multiple representations. (Der Meij & De Jong, 2006) ii) Make students actively integrate visualizations themselves (Ainsworth, 2006) iii) Show integration of representations (Ainsworth, 2006)	Design a group activity where the instructor will: i) Give a focus question, for each aspect of the information that requires students to vary parameters in one representation and simultaneously reflect on the change in the other representation (for e.g. graph and equation). ii) Follow up with an activity that asks students to integrate all the aspects into a whole (for e.g. for signal transformation, represent each transformation type individually & then integrate) iv) Play the visualization that does all of the above steps to provide feedback.

‘Multiple Process’ Learning Design						
Instructional Objective with visualization Use given visualization to compute the solution to the given problem by executing multiple processes		Instructional Strategy to use: i. Any collaborative strategy that incorporates instructional design components specified in CVI guidelines. ii. Here, ‘Think-Pair-Share with Visualization’ is taken as an example strategy to illustrate execution.			Index: ○ Visualization use	
STEP	Step 1		Step 2		Step 3	
Phase	Think		Pair		Share	
Time	3-5 minutes		5-10 minutes		12-15minutes	
Who	Instructor	Student	Instructor	Student	Instructor	Student
What	A. Write an initial (seed) question. For e.g. Refer below. B. Show input data of problem on-screen through visualization ○	INDIVIDUAL Activity A. ‘Thinks’ about what they know B. Writes down answer to seed question.	A. Ask follow-up question related to seed question B. But of higher difficulty level For e.g. Refer below	GROUP Activity A. Teams up & shares their answers to seed question with team members B. Proceeds with answering follow-up question as a group	A. Invite few student groups to share their answers with class B. Run the visualization with same input values as in Step 1. C. Highlight important objects/ actions in the system & the causal relation between them D. Summarize & move on ! ○	GROUP Activity A. Compares their solution & notes the difference with solution shown through visualization B. Gets instructor feedback on their solution
Activity Design Tips	A. Question should be broad enough for every student to attempt. B. There should be a clear deliverable.		A. Make student groups of 2-3. B. Question connected to seed question but of higher difficulty. C. Clear deliverable for the pair D. Question specific enough to lead into the discussion you want to carryout later.		A. Anticipate a few likely responses B. Give about 1 min. to each group to explain their answer C. Highlight important points of each answer D. Invite answers that are conceptually different from previous ones E. Measure of success: Many of the points you wanted to convey got covered already	
Example	If $y(t) = (x - 4t/2)$, for the $x(t)$ shown on screen: a) Identify the transformation operations. b) Identify their sequence c) Draw the signal after the 1st operation.		a) Identify errors, if any, in each other’s ‘Think’ phase answer b) Together draw stepwise the final transformed signal.		a) Share your solution with class. b) Now compare your solution with solution shown in visualization c) Note the errors in your solution	

Figure 1: Sample Learning Design mapped to ‘Multiple Process’ objective

5. Validating CVI Framework

To validate the CVI framework, we conducted a two-group controlled field experiment in a tutorial class on the topic of ‘Signal Transformation’ in ‘Signals and Systems’ (Electrical Engineering). The experimental group (N= 70) performed a 30 minute instructional activity designed as per CVI guidelines for four objectives (Table 3) that formed the core of problem solving for the chosen topic. The control group (N= 74) activity was of same duration but was not based on CVI guidelines for three of the objectives (Table 4). The CVI guideline for the fourth objective, involving problem solving with a single process, was the control group activity of watching the visualization with instructor commentary. This guideline was included for validation since we wanted to verify that a non-constructivist activity was sufficient if the objective was at simple recall/reproduction level. Student interaction with visualization for both the groups was mediated through the instructor. After the visualization activity, both groups solved the same post-test questions for 30 minutes. The post-test

results of the two groups were compared through non-parametric Mann-Whitney U test since the test scores showed non-normal distribution. The experimental group did statistically significantly better than the control group for the three objectives where CVI guidelines were followed by the experimental group activity (Table 4). For the fourth objective of problem solving with a single process, both groups performed equally well as expected. These results validated the CVI guidelines.

Table 3: Sample of Experimental group activity derived from CVI guidelines.

Instructional Objective with Visualization	Experimental group activity derived from CVI guidelines
Write/Draw alternate representations from the given representation in the visualization or vice-versa.	<ul style="list-style-type: none"> • Think Phase (5 minutes) [Individual activity] <ol style="list-style-type: none"> a) Identify what transformation operations are happening in given equation. b) Draw & write down mathematical expression for the first transformation • Pair Phase (10 minutes) [Collaborative activity] <ol style="list-style-type: none"> a) Discuss and draw stepwise the final transformed signal with the mathematical expression for each step. • Share Phase (15 minutes) [Feedback] <ol style="list-style-type: none"> a) Compare your answer with the solution shown by the visualization

Table 4: Mann-Whitney U test results for post-test.

Instructional Objective Categories	Experimental group: activity based on CVI guidelines?	Control group: activity based on CVI guidelines?	Experimental Group Mean (SD) [Total Marks]	Control Group Mean (SD)	Significant difference?
1. Visualize to explain a specified concept	√	X	2.86 (0.43) [3 marks]	2.42 (0.84)	Yes (U=1853 p= 0.00)
2. Use a given visualization to solve the given problem by executing multiple processes	√	X	4.36 (1.18) [5 marks]	3.47 (1.71)	Yes (U=1883 p=0.001)
3. Write/Draw alternate representations from the given visualization or vice-versa.	√	X	2.56 (0.77) [3 marks]	1.86 (1.15)	Yes (U= 1744 p= 0.00)
4. Use a given visualization to solve the given problem by executing single process	√	√ [CVI guideline of watching with instructor commentary met]	3.34 (1.34) [4 marks]	3.51 (1.29)	No (U= 2416 p= 0.5)

6. Discussion & Conclusion

In this section we summarize the results corresponding to each research question. We then discuss the implications of the study, its limitations and scope for future research. The first research question was answered through a qualitative study covering multiple domains and a range of visualizations. Eleven categories of instructional objectives with visualizations were identified across different instructional settings. The second research question was answered by analysis and synthesis of literature. A set of instructional strategy design components, mapped to individual objectives, were identified to achieve strategic alignment. Based on this mapping, we framed guidelines for instructors to design learning activities aligned to their objectives with visualization (Table 2). CVI also offers learning designs (LDs) mapped to particular objectives. These LDs operationalize the recommended design components through a sample set of constructivist strategies (Fig. 1). The third research question was answered through a 2-group post-test only field experiment. We measured successful constructive strategic

alignment through significantly better post-test scores of the experimental group which followed CVI guidelines compared to the control, for each of the objectives (Table 2). Though visualization selection is an important first step, in this paper we have focused on integration of visualization in teaching.

The contributions of the CVI framework are outlined below. The CVI guidelines and learning designs empower instructors to create theory-informed learning designs integrating visualizations and aligned with their set of instructional objectives. Thus CVI enables instructors to overcome the problem of how to effectively integrate visualization in teaching. There are, however, certain limitations to the CVI in its current form. Our sample base for identifying objectives was restricted to K -16 science and engineering instructors. The objectives included in CVI may not be exhaustive for non-science domains and K -12 instructors. Also, the objective identified may be a function of the cultural context of the study i.e. urban Indian classrooms. In such classrooms students do not have individual access to laptops within the class although they are otherwise technology savvy. Another limitation is that validation of CVI guidelines has been done in one topic and in one domain. As part of future work, the current validation experiment can be extended to include different 'Signals and Systems' topics together with topics from other domains and cover the remaining CVI guidelines. The usefulness and usability of the CVI guidelines and LDs also need to be tested with instructors. Overall, the CVI framework aims to plug the existing gap in integration of visualizations in teaching by identifying instructional objectives with visualization, providing guidelines for constructivist strategic alignment and presenting learning designs mapped to individual objectives to ensure implementation fidelity of the mapping.

Acknowledgement

The authors would like to thank Project T10KT and NMEICT, Government of India for their support.

References

- Ainsworth, S. (2006). DeFT: A conceptual framework for considering learning with multiple representations. *Learning and Instruction*, 16(3), 183-198.33d.
- Biggs, J. (1996). Enhancing teaching through constructive alignment. *Higher education*, 32(3), 347-364.
- Boyle, T. (2010). Layered learning design: Towards an integration of learning design and learning object perspectives. *Computers & Education*, 54(3), 661-668.
- Bratina, T. A., Hayes, D., & Blumsack, S. L. (2002). Preparing teachers to use learning objects. *The Technology Source*, 2.
- Cohen, S. A. (1987). Instructional alignment: Searching for a magic bullet. *Educational Researcher*, 16(8), 16-20.
- Conole, G., Dyke, M., Oliver, M., & Seale, J. (2004). Mapping pedagogy and tools for effective learning design. *Computers & Education*, 43(1), 17-33.
- Corbin J. & Strauss A. (Eds.) (2008). Basics of qualitative research: Techniques and procedures for developing grounded theory. Sage.
- Ebert-May, D., Derting, T. L., Hodder, J., Momsen, J. L., Long, T. M., & Jardeleza, S. E. (2011). What we say not what we do: effective evaluation of faculty professional development programs. *BioScience*, 61(7), 550-558.
- Hess, K.K., Jones, B.S., Carlock, D., & Walkup, J.R. (2009). Cognitive rigor: Blending the strengths of bloom's taxonomy and Webb's depth of knowledge to enhance classroom-level process. *National Center for the Improvement of Education Assessment*, NH.
- McConnell, J.J. (1996). Active and group learning techniques and their use in graphics education. *Computers & graphics*, 20(1), 177-180.
- Merrill M.D. (1983). Component display theory. *Instructional-design theories and models: An overview of their current status*, 1, 282-333.
- Morrison, G.R., Ross, S.M., Kemp J.E. & Kalman, H. (2010). Designing effective instruction. Wiley.
- Mor Y. & Brock C. (2012). Learning design: reflections upon the current landscape. *Research in Learning Technology*, 20.
- Rutten, N., van Joolingen, W. R., & van der Veen, J. T. (2012). The learning effects of computer simulations in science education. *Computers & Education*, 58(1), 136-153
- Shaffer, C. A., Akbar, M., Alon, A. J. D., Stewart, M., & Edwards, S. H. (2011). Getting algorithm visualizations into the classroom. *42nd ACM technical symposium on Computer science education*, 129-134.
- Tory M. & Moller T. (2004). Rethinking Visualization: A High-Level Taxonomy. *IEEE Symposium on Information Visualization*, 151-158.
- Van der Meij, J., & de Jong, T. (2006). Supporting students' learning with multiple representations in a dynamic simulation-based learning environment. *Learning and Instruction*, 16(3), 199-212.

Practice of the Programming Education

Using Arduino and the Class Support System

Kazuo TENRA
Tokyo Metropolitan Koishikawa Secondary Education School, Japan
tenra.kazuo@nifty.com

Abstract: A school setting course "Introduction to Arduino" in my school is characterized by Cross-Curriculum and Problem Solving learning on information science, physics, and mathematics, and by Flip Teaching using cloud servers. The author constructed a class support system to carry out this course and was able to develop students' originality in a short time by utilizing the system.

Keywords: Physical Computing, Arduino, Programming, Flip Teaching, Cross Curriculum, Problem solving, 3G Shield (3rd Generation)

1. Introduction

The school setting course "Introduction to Arduino" is intended to bring up students' originality by creating their ingenious works (devices) using microcomputers which are designed to achieve physical computing easily, such as Arduino. This course incorporates cross-curriculum and problem-solving learning. This course also incorporates "flip teaching" and achieved the educational effect intended. Namely, teachers upload the teaching contents on cloud servers and students study them at home beforehand. At school, students conduct various activities in order to create their own works. We also constructed a class support system to conduct flip teaching, and could produce favorable results in a short time.

2. Programming education Arduino in Koishikawa

2.1 *Characteristics of the programming education using Arduino*

In Koishikawa, programming education using Arduino has been performed in the school setting course "Introduction to Arduino", in club activities after school, and in open laboratories.

In order to perform activities for creating original works using Arduino, it is necessary for students to have cross-curriculum problem solving ability. It is made up of programming technology (Information Science) as a core component, and of sensor technology (physics), formula manipulation (mathematics), and so on. To develop those abilities is a purpose of this course, and it allows students to experience "cross-curriculum problem solving learning".

This course has only two hours a week, and it is difficult to achieve the purpose by doing the traditional style of teaching for the whole class.

As a result, I started "flip teaching" using cloud servers.

Students watch teaching materials which a teacher uploaded on the cloud servers such as a video sharing site (YouTube) or on the online storage (OneDrive) at home as preparations for lessons. At school, the teacher can give the individual instructions to the students. In addition, students can perform activities to create their works while cooperating with each other based on the knowledge that they got from the preparations. In this way, it was available to bring up students' originality, instead of conducting knowledge transmission-centered classes.

2.2 Class recording system for programming education

In the school setting course "Introduction to Arduino", I recorded the video materials with the class recording system which I devised, and uploaded it in the video sharing site.

Students watched them as preparations for lessons at home, etc., and they conducted activities at school for solving problems and creating devices based on the knowledge that they had learned.

It is desirable to install the encoder (Microsoft Expression Encoder) in the console machine (shown in Figure 1). The author also used a capture box to connect the teacher's machine and the console machine. It connects the audio output of the teacher's machine to the audio input of the console machine. It also captures the video signals on the screen of the teacher's machine and sends them to the USB terminal of the console machine. The encoder in the console machine encodes data from the USB terminal and generates the movie file of the WMV form. If the destination to save the video file is set to the server machine, load of the console machine decreases.

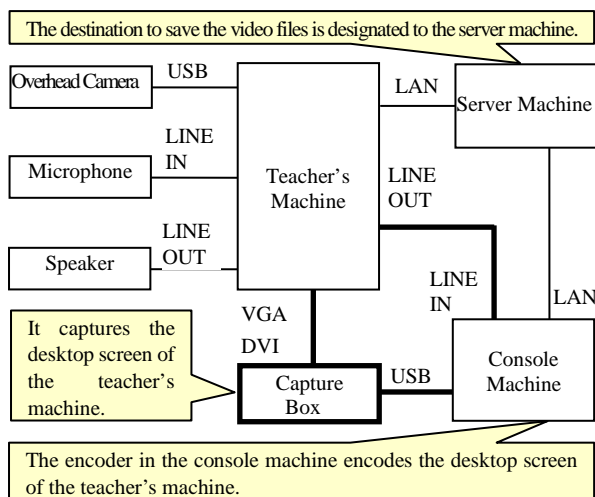

Figure 1. Class recording system
(Bold line parts are added)

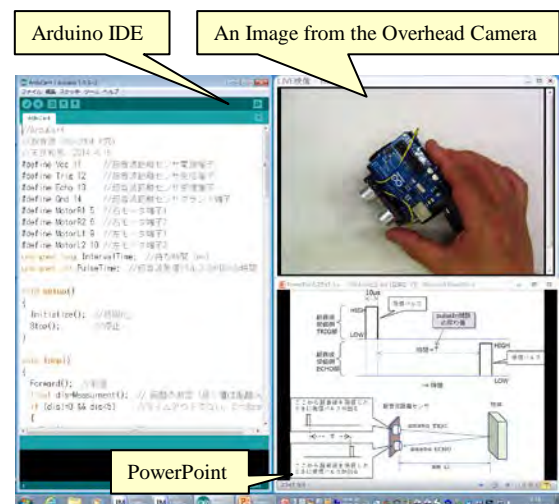

Figure 2. An example of the teaching material.
(Recording a video of the desktop screen of the teacher's machine.)

Figure 2 is an example of the desktop screen. Teaching materials to be used in the school setting subject "introduction to Arduino" are recorded on the desktop.

In the screen of Figure 2, a supersonic wave range sensor is attached to Arduino. It shows the example of structure and the program of measuring distance. In the top right corner, a picture of Arduino is displayed. A supersonic wave range sensor is attached to it using overhead camera. In the lower right corner, an explanatory figure is displayed with PowerPoint. It explains the structure about how the supersonic wave range sensor measures distance

In the left, Arduino IDE (Integrated Development Environment) is displayed. The program to measure distance is shown in it.

To use these systems makes it possible to prepare teaching materials that include a picture from overhead camera, PowerPoint, other software, and the sound from a microphone at the same time and in real time, like a DVD recorder.

The recorded videos are uploaded to the video sharing site of Google (YouTube). YouTube has a limited disclosure option without opening to the public in the world.

It is enabled by telling a URL of the uploaded videos to only authorized persons.

The author uploaded files which I recorded through the system mentioned above, and opened it only to the students who took my course.

The author also uploaded the corresponding files except the video files to an online storage OneDrive (former name SkyDrive) by Microsoft.

The students can watch videos to prepare for lessons using these files at home.

At school, based on the knowledge that they got from the preparations for lessons, they performed activities for the problem solving and the creating something that each student set as a goal.

2.3 Contents of the School Setting Course "Introduction to Arduino"

2.3.1 Annual instruction plan

This year's annual instruction plan for this course (2 hours a week) is as follows.

Particularly, the content of the learning in the first half of the first term at home is to acquire basic knowledge to handle Arduino. It will take around one year to acquire them in the form of the conventional mass teaching. However, by studying in advance at home using the cloud environment, students can finish within the period

(1)The first half of the first term (from Early April to Last May)

- At home (prior learning in the cloud environment)

Students learn about functions of Arduino, how to use it, analog and digital, digital input, digital output, analog input, analog output, binary numbers, programming (variable, substitution, input and output, sequential, divergence, repetition, function, etc.) and various sensors. (temperature, light, infrared proximity, supersonic wave, etc.)

- At School (creative activities by each student)

Students perform operation confirmation experiments on sample programs using Arduino.

(2)The latter half of the first term (from Early June to Mid-July)

- At home (prior learning in the cloud environment)

Students research various works of Arduino on the Internet based on knowledge and the experience they got in the first half of the first term. In reference to them, each student devises an original work (including the summer vacation).

- At School (creative activities by each student)

Students perform inspection experiments with Arduino and various sensors to confirm the feasibility of the works they devised.

(3)The first half of the second term (from Early September to Mid-October)

- At home (prior learning in the cloud environment)

Students think about algorithm to move their original devices on Arduino and upload document files to a cloud server.

- At School (creative activities by each student)

Students attach various sensors to Arduino and produce physical devices.

Students perform operation checks using Arduino at home referring to the document files they uploaded in which they wrote down the algorithm.

(4)The latter half of the second term (from Late October to Mid-December)

- At home (prior learning in the cloud environment)

Students make materials (documents and files for presentation) to apply for contests, and upload them to a cloud server.

- At School (creative activities by each student)

Students practice presentation in front of other students to prepare for contests using the file which they uploaded.

Students complete their works at the same time. Participation in contests (Late November)

(5)The third term (from Mid-January to Mid-March)

- At home (prior learning in the cloud environment)

Students prepare for school presentation, make articles, and upload them to a cloud server.

- At School (creative activities by each student)

Students practice presentation in front of other students using the file which they uploaded.

- School presentation and paper submission (Mid-March)

2.3.2 Examples of Cross-Curriculum Teaching Materials for "Introduction to Arduino"

The teaching materials which the author made for home learning are made up of videos and presentation files for explanation. These are uploaded on cloud servers such as YouTube or OneDrive, and are the teaching materials to develop students' cross-curriculum ability among information science, physics, and mathematics. Figure 3 is a part of them. It shows the way to treat a temperature sensor in Arduino (shown in Figure 4).

We can see that "analog and digital" and "programming" are related to the subject "information science", "temperature" and "voltage" are related to the subject "physics", "primary function" is related to "mathematics" from the teaching material above.

Thus, it is possible to develop students' cross-curriculum ability by using Arduino.

Let the analog input voltage of the AD converter stand for V , and the digital value corresponding to it stand for D , and it equals to expression(1) in the 10-bit AD converter, where $D=0\sim 1023$ (integer value), $V=0\sim 5$

$$V = \frac{5D}{1023} \quad (1)$$

The output voltage of the temperature sensor is 0.6[V] in the case of 0[°C]. It changes 0.01[V] with respect to the temperature change of 1 [°C]. They are shown in a graph on the lower right hand side. The output voltage V_{out} [V] in case of t [°C] is as follows.

$$V_{out} = 0.01 t + 0.6 \quad (2)$$

The output voltage V_{out} of the temperature sensor equals to the input voltage of the AD converter, therefore V in the expression (1) equals to V_{out} as in expression (3).

$$V_{out} = \frac{5D}{1023} \quad (3)$$

From expression (2), expression (3),

$$t = 100V_{out} - 60 = \frac{500D}{1023} - 60 \quad (4)$$

The program in Arduino, expression (4) is as follows.

```
int value = analogRead(A0); // analog input
//convert to temperature
float temperature = 500*(float)value/1023 - 60;
```

Element of Information Science (Analog and Digital)

Element of Physics (Temperature, Voltage)

Element of Mathematics (Linear Function)

Element of Information Science (Program)

Figure 3. The example of the teaching material which includes cross-curriculum contents.

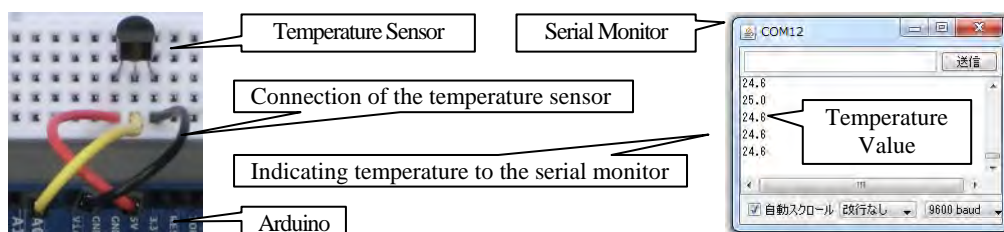

Figure 4. Connection of the temperature sensor and indicating temperature to the serial monitor

2.4 The example of a student's work

A student participated in the open laboratory (open study) last year, and the work that the student devised won the Excellence Award in a contest. (3G shield idea contest)

The summary of the student's work is as follows. This is a work which was made in combination with Arduino and 3G Shield (Figure 5 – Figure 6). 3G Shield is an expansion board for the 3rd generation mobile communication network intended for cellular phones and smart phones.

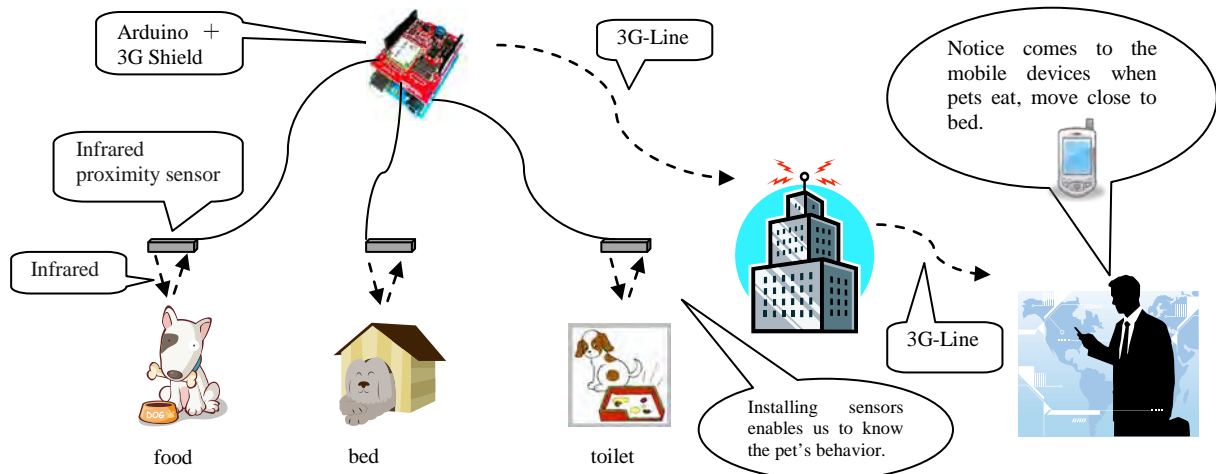

Figure 5. Schematic diagram of a pet management system (student's work)

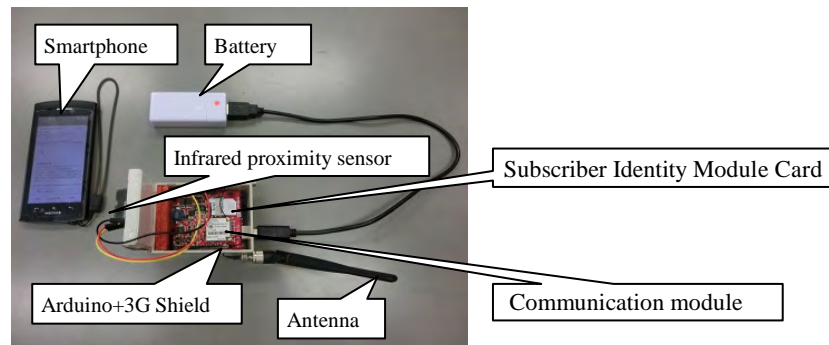

Figure 6. Pet management system (student's work)

The work title is "Pet management system". The purpose is to know the pet behaviors even if the owner of the pet is away with Arduino and a 3G shield.

Arduino is combined with 3G shield. It enables the pet owners to grasp the approximate behaviors of the pet by connecting an infrared proximity sensor and installing it on the dish, bed, restroom, etc. downward. An email will be transmitted to a cell-phone or a smartphone when the pet gets closer to an infrared proximity sensor. It can also be applied to the simplified home security as well.

3. Evaluation and Analysis

The author conducted a survey in the form of a questionnaire at school setting course "Introduction to Arduino".

Table1. Questionnaire (N=15)

	1	2	3	4	5	Mean	S.D.
Question1	0(0.0%)	0(0.0%)	4(26.7%)	5(33.3%)	6(40.0%)	4.13	0.81
Question2	0(0.0%)	1(6.7%)	4(26.7%)	7(46.7%)	3(20.0%)	3.80	0.83
Question3	0(0.0%)	2(13.3%)	3(20.0%)	6(40.0%)	4(26.7%)	3.80	0.98

Based on a 5-point Likert scale: 1 = very low, 2 = low, 3 = normal, 4 = high, 5 = very high

Question 1. Were the teaching materials uploaded in YouTube and One Drive easy to understand?

Question 2. In order to build a new system using Arduino and sensors, you had to introduce problem-solving learning, combining the knowledge of various subjects such as information, physics, and mathematics together. Were you able to understand such a technique?

Question 3. This course employs flip teaching. In flip teaching, you will watch videos at your house to prepare for the lesson, and address various tasks without listening to explanations in the lesson. Were you able to keep up with the flip teaching?

The ratio of the affirmative response to the question 1 was about 73%.

The reason for the positive responses is considered that students could learn repeatedly because the teaching materials were given by video format.

The ratio of the affirmative response to the question 2 was about 67%.

In the lesson using Arduino, students need not only the knowledge of programming, but also the problem-solving learning in which students combine the knowledge of sensor technology and formula manipulation, and so forth. Considering the responses, students were able to feel the novelty and fun in the lessons which many conventional subjects do not have. The student who made a negative response might feel a sense of incongruity in the difference from the conventional classes.

The ratio of the affirmative response to the question 3 was also about 67%. On the other hand, there were about 13% of negative responses. The standard deviation was the biggest in three questions. In order to watch videos before a lesson, decent efforts and active engagements of the students are required. Since this course was an optional, many students were already motivated and that led to the sufficient result. However, two students were not able to achieve the purpose.

4. Conclusion

(1) There are such effects by using Arduino and various kinds of shields that students can easily learn the most advanced, leading-edge technologies in a short time, and students can expand the creativity.

(2) The view may be becoming a thing of the past that each subject cultivates students' abilities and those will work as a basis when students get out into the world. The abilities which are useful in the society will be promoted better through cross-curriculum learning. The programming lessons using Arduino enables students to foster cross-curricular and problem-solving abilities effectively.

(3) The merits of the flip teaching: for the students who are eager and motivated, their academic abilities will be all the more increased because they can learn repeatedly. For the students who are not eager and motivated, they can learn repeatedly watching videos again and again, and the videos can be used as reviews, students' time for study at home will increase, and so forth.

The demerits of the flip teaching: to correspond to the students who will not prepare the lesson. However, that should not be regarded as a demerit because it is not limited to the flip teaching.

References

Takayori TAKAMOTO & Kazuo TENRA. (2012). Development of 3G shield for Arduino and Practice in the education : Japanese Association for Education of Information Studies 5th Annual Conference Proceedings (pp.43-44). Shinshu University.

Taisuke HORIUCHI & Takashi MIYAZAKI. (2013). Developing the physical computing educational environment using Arduino : Japanese Association for Education of Information Studies 6th Annual Conference Proceedings (p.126). Tokai University.

Kazuo TENRA. (2014). Practice of School setting subjects "Physical Computing Introduction" : Japanese Association for Education of Information Studies 7th Annual Conference Proceedingspp.5-6. Chitose Institute of Science and Technology.

Kazuo TENRA. (2014). Construction of the Class Support System and Flip Teaching in Information Studies : Japanese Association for Education of Information Studies 7th Annual Conference Proceedings. pp.117-118 Chitose Institute of Science and Technology.

Predicting the Perceived Usefulness of eBook among Mathematics Teachers

^aAzlin ABDUL JALAL, ^bAhmad Fauzi MOHD AYUB, ^cRohani AHMAD TARMIZI

^{abc}*Institute of Mathematical Research, Universiti Putra Malaysia*

^{bc}*Faculty of Educational Studies, Universiti Putra Malaysia*

azlinabduljalal@yahoo.com, afmy@upm.edu.my, rohaniat@gmail.com

Abstract : The introducing of the one-to-one eBook for each students were said to be an important move to encourage technology integration in mathematics classrooms. This study sets out to examine the perceived usefulness of the eBook among Mathematics teachers, where the affects of four predictors, namely the critical mass, learning opportunities, facilitating conditions and personal innovativeness were assessed. Using validated questionnaires, a survey was conducted involving 304 mathematics teachers. Structural Equation Modeling (SEM) was used to analyse the data obtained. The result showed that 62.6% of variance of perceived usefulness was explained by the four exogenous variables. Critical mass, learning opportunities and facilitating conditions were found to significantly affecting perceived usefulness while the personal innovativeness did not.

Keywords : eBook, Mathematics teachers, perceived usefulness, critical mass, learning opportunities, facilitating condition, personal innovativeness

1. Introduction

The effort to integrate technology into mathematics teaching and learning depends firmly on the teachers' perception on its usefulness. Assuming that, teachers who do not believe that technology utilization will fulfill their needs and also their students', would most probably avoid using technology in their lessons (Teo, 2012). One predictor factor that was found to strongly predict the teachers' attitude towards using technology is the perceived usefulness. The attitude, which is either positive or negative, will in turn influence the behavioral intention to use a specific technology.

Many experts in educational technology believed and agreed that technology use in school could not reach the maximum effectiveness until the computer is no longer shared (Bebell & Kay, 2010). Since a decade ago, a new educational transformation has emerged when more than 40 countries across the world have provided laptops to teachers and students without sharing (Mo et al., 2013). In Malaysia, the state Terengganu was among the first to introduce this concept of one-to-one laptops in 2009 in the vision to produce techno-savvy citizen (Wan Muhammad Amir et al., 2013). The eBook provided in the initiative is a low-cost netbook computer or a mini laptop, able to connect to the Internet and also installed with the digital textbook softwares. Students nowadays, dubbed as the generation Y preferred a flexible learning environment, yet not replacing the traditional teaching but enhancing the students' learning experience (Jazihan, Ahmad Fauzi, & Wong, 2012)

Despite the large amount of money spent, the use of computers by teachers in classrooms remains minimal and inefficient (Ministry of Education, 2013; Teo, 2009). In addition, students and parents reported that the time spent by mathematics teachers using laptops in the classrooms is half the time spent using laptops for other subjects such as Science and English (Zuber & Anderson, 2012). Numerous studies on one-to-one laptop consistently reported that utilization in mathematics classroom has the lowest rate compared to other subjects without elaboration of the reasons (Bebell & Kay, 2010).

Hence, this study is based on the Technology Acceptance Model (TAM) which rooted from Theory of Reasoned Action (Fishbein & Ajzen, 1975) that posits that users' technology acceptance is determined by their perceptions on the usefulness and the ease of use of technology (Davis, Bagozzi, & Warshaw,

1989). The model was designed to explain and predict users' acceptance on any types of technology and have been widely tested in series of empirical studies for validity. Recent educational research using TAM in Malaysia include studies by Jazihan, Ahmad Fauzi, & Wong (2013) and Ariff, Yeow, Zakuan, Jusoh, & Bahari (2012). In the recent study, perceived usefulness is highlighted as it is the core determinant of behavioral intention in TAM, which is the main factor that may affect the use of a technology (Davis et al., 1989). Perceived usefulness could possibly be affected by numerous external variables depending on the needs and research area (Davis et al., 1989). In this study, four external variables were carefully selected based on literatures and research needs namely the critical mass, learning opportunities, facilitating condition and personal innovativeness.

A person will use a certain technology if it is useful in helping him/her perform better in his job (Davis, 1989). In the context of education, perceived usefulness can also be seen in the students' test performance. Scales were refined and developed by Davis (1989) and defined explicitly as "the degree to which a person believes that using a particular system would enhance his or her job performance" (Davis, 1989). An important social factor identified on adoption and acceptance of technologies is the perceived critical mass. The adoption and communication media use were then explained in the critical mass theory where a technology value boost exponentially to the total number of the users (Lou, Luo, & Strong, 2000). In the context of technology adoption, Bourgonjon et al., (2013) describes critical mass as the idea that a technology's utilization rate is slow until a certain number of users have used and accepted the technology. Learning opportunities, however is the learning process and the opportunities given in the process, defined as 'the degree to which a person believes that using a particular system can offer him or her opportunities for learning' (Bourgonjon, Valcke, Soetaert, & Schellens, 2010). Other professionals may work hard towards personal effectiveness, but most teachers strive to inspire their students to reach the learning goals. Next, Teo, Lee and Chai (2007) defined facilitating conditions as factors present in the surroundings that may affect an individual's desire to perform a task which may involve skill training, administrative support and the availability of materials and sufficient information on technology usage. Another predictor factor is personal innovativeness. Agarwal & Prasad (1998) introduced the term 'personal innovativeness in the domain of information technology' which is described as the willingness to take up and try a new information technology introduced. Personal innovativeness acts as the identifier of individuals who would possibly accept technology earlier than the others. Hence, the hypotheses of this study are:

H₁ : Critical mass positively affect perceived usefulness

H₂ : Learning opportunities positively affect perceived usefulness

H₃ : Facilitating conditions positively affect perceived usefulness

H₄ : Personal innovativeness positively affect perceived usefulness

2. Methodology

Respondents selected to participate in this study were 304 mathematics teachers in primary schools across Terengganu, Malaysia. A survey study was administered, where previously validated questionnaires were adapted and used in this study. Selected with the proportionate stratified sampling, the mathematics teachers then provided their demographics details and responded to 20 items which comprises of four items in perceived usefulness, three items for critical mass, five items for learning opportunities, facilitating conditions (three items) and three items for personal innovativeness. Each item was measured on a five-point Likert scale with 1 (strongly disagree) to 5 (strongly agree). These adapted items from numerous published sources have demonstrated good reliability in measuring the constructs employed in the present study. In this study, the reliability test conducted also yielded sufficient Cronbach's alpha value for perceived usefulness (.956), critical mass (.876), learning opportunities (.948), facilitating condition (.892) and personal innovativeness (.812) indicating good reliability in the adapted questionnaire.

3. Results

The respondents' general demographic information is that, from 304 Mathematics teachers participated, 126 (41.4%) of them are male teachers and 178 (58.6%) are female. Experienced teachers with more than 20 years of teaching mathematics are only 16.8 percent of those who took part in this study while most of them are between 11-20 years of experience in teaching mathematics. Almost all (95.1%) mathematics teachers in this study have Internet access at home. However, most of them only spend less than three hours a day to surf the internet. A small minority of 6.3% spent more than five hours a day surfing the net. It also shows that around 57.6% of the teachers use the eBook only about an hour or less in a day and the ones who use the eBook regularly more than 3 hours a day consist of only about 12.5% of the teachers surveyed.

Normality is one of the most important assumptions to be tested in a multivariate analysis for it refers to the normal data distribution for individual metric variables (Hair, Black, Babin, & Anderson, 2010). The assessment of univariate normality using AMOS is done by reporting the statistical skewness and kurtosis and the assumption of normality was met and fulfilled for each construct. Convergent validity determines the value of common variance in the indicators of each construct. As suggested by Hair et al.(2010), there are three ways to estimate convergent validity which is by assessing the factor loading, average variance extracted (AVE) and Construct Reliability (CR). The size of the factor loading should be 0.5 or larger. In this study, as shown in Table 2, all factor loadings are more than 0.7. The second measure is calculating the AVE and the criterion value of AVE accepted is 0.5 or higher (Hair et al., 2010). Thirdly, similar to the Cronbach's alpha values, the construct reliability is met if the values of CR are 0.7 or higher. In this model, all values of CR are more than 0.7 and therefore, the initial measurement model satisfies the convergent validity.

Table 2. Results of the measurement model

Construct		Factor loading	AVE (>0.5)	CR (>0.7)
CM1	Most teachers in my school use eBook frequently	0.892	0.736	0.893
CM2	Most mathematics teachers I know use eBook frequently	0.872		
CM3	My friends who are teachers in other schools use eBook frequently	0.808		
LO1	eBook allows my students to experience things that they learnt about in the mathematics classroom	0.809	0.724	0.929
LO2	eBook offers opportunities for my students to interact with each other	0.785		
LO3	eBook offers opportunities for my students to think critically	0.878		
LO4	eBook offers opportunities to motivate students to learn mathematics	0.900		
LO5	eBook helps my students to explore mathematical ideas	0.878		
FC1	When I need help to use the eBook, someone is there to help me	0.767	0.590	0.891
FC2	ICT Coordinator is always available to give advice on eBook usage in teaching	0.864		
FC3	Executive Information Officer (EIO) is always available when there are technical problems	0.713		
FC4	Guidance is available for me in the selection of software to choose for my mathematics lessons	0.72		
PI1	I want to explore the new eBook introduced	0.817	0.699	0.874
PI2	I like to experiment with new technologies	0.849		
PI3	I think it is very interesting to try out new technologies	0.842		
Use1	Using the eBook can improve my teaching performance in the mathematics classrooms.	0.855	0.811	0.945
Use2	Using the eBook increases my teaching effectiveness in mathematics.	0.926		
Use3	Using the eBook makes my mathematics teaching easier	0.92		
Use4	Using the eBook helps my students to achieve better marks in mathematics	0.899		

The model fit of the research model in this study was tested using AMOS 21.0. Researchers usually employ different indices to determine model fit (Brown, 2006). Hair et al. (2010) suggested to at least test and report the one index from the incremental fit, one from the absolute fit index, one goodness-of-fit, and one badness-of-fit. Therefore, in the present study, the researcher has chosen to use four fit indices which are the CFI, TLI (incremental fit category), RMSEA (absolute fit category) and Chisq/df (parsimonious fit category) to test the model fit.

Table 4. Fit indices for the research model

Fit Indices	Values	Recommended values
χ^2/df	2.381	< 3.0
TLI	.949	$\geq .90$
CFI	.958	$\geq .90$
GFI	.900	$\geq .90$
RMSEA	.068	< .08

Hair et. Al (2010), (Schumacker & Lomax, 2010)

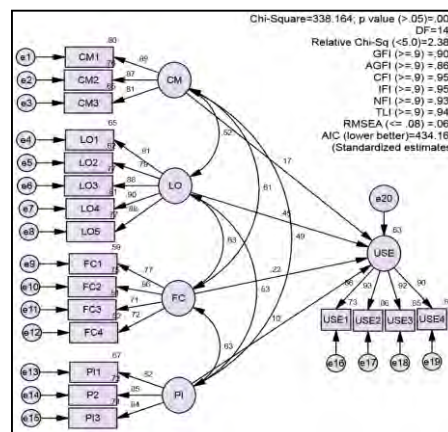

Figure 2. The Structural Model

Discussion

Employing the Structural Equation Modeling, fitting our data to the model explained 62.6% of the variance in perceived usefulness of eBook use among mathematics teachers in Terengganu. The study also found that critical mass ($\beta=.170$, $p<.01$), learning opportunities ($\beta=.454$, $p<.001$) and facilitating conditions ($\beta=.215$, $p<.01$) have significant positive effects on teachers' perceived usefulness of eBook use in teaching and learning. This findings are in congruent with current research (Bourgonjon et al., 2013; Moses, Wong, Kamariah, & Rosnaini, 2013). Learning opportunities were found the strongest determinant of perceived usefulness, which was seen parallel to the previous studies (Bourgonjon et al., 2013; De Grove et al., 2012; Roslina, et al., 2011).

Personal innovativeness however, was found not significant in affecting the perceived usefulness ($\beta=.096$, $p>.05$). This contradicted the findings of many studies previously done, including studies by Bourgonjon et al. (2013), Smet et al.(2012) and Liu, Li, & Carlsson (2010). This might be because that Mathematics teachers who are innovators, high in personal innovativeness are always willing to try new technologies and wanting to be the first to try something new, have seen more advanced technology such as the tablets and updated laptops and have become too familiar with computers such as the eBook, making them see the limited usefulness of the eBook as an effective learning tool. This however, could be validated by further research.

Conclusion

The study confirmed critical mass, learning opportunities and facilitating conditions as strong predictors of perceived usefulness of eBook among mathematics teachers. It is of significance relevance to the Ministry of Education and Education Department which are responsible for ushering in new developments and

technologies in the education system. Overcoming the teachers' resistance to change has always been a major issue in managing changes. Hence, in ensuring smooth technology acceptance in a changed education scenario, such as this one-to-one eBook, the study clearly implied the need to seriously consider on holding carefully planned trainings and guidance for teachers, specifically on samples of good mathematics teaching and learning using the eBook and most importantly the digital textbook provided. Certain infrastructures such as the slow internet connection and the insufficient power supply to charge the individual eBook batteries were also brought up during the school visits. To show that the eBook provide high learning opportunities, information should be easily accessible, the digital textbook should not only consists of text and diagrams, but instead, complete with videos and animations that would get the students to see how to apply mathematics in everyday life, get to experience and experiment with their mathematical knowledge and explore mathematical ideas. Regarding critical mass, the encouragement and support from superiors and seeing successful usage among peers will motivate utilization of eBook by mathematics teachers. This research is however, done in a quantitative approach where the instruments used were only self-report questionnaires. It is recommended that the study could be more in depth, if done using more instrumentation such as interviews, classroom recordings and also observations. Future studies could be done using the mix method study, also including the quantitative part or could also be totally qualitative. This could provide more comprehensive insights and understanding of the students and also teachers on the acceptance of eBook in mathematics lesson.

References

- Agarwal, R., & Prasad, J. (1998). A Conceptual and Operational Definition of Personal Innovativeness in the Domain of Information Technology. *Information Systems Research*, 9(2), 204–215. doi:10.1287/isre.9.2.204
- Ariff, M. S. M., Yeow, S. M., Zakuan, N., Jusoh, A., & Bahari, A. Z. (2012). The Effects of Computer Self-Efficacy and Technology Acceptance Model on Behavioral Intention in Internet Banking Systems. *Procedia - Social and Behavioral Sciences*, 57, 448–452. doi:http://dx.doi.org/10.1016/j.sbspro.2012.09.1210
- Bebell, D., & Kay, R. (2010). One to One Computing : A Summary of the Quantitative Results from the Berkshire Wireless Learning Initiative. *The Journal of Technology, Learning and Assessment*, 9(2).
- Bourgonjon, J., De Grove, F., De Smet, C., Van Looy, J., Soetaert, R., & Valcke, M. (2013). Acceptance of game-based learning by secondary school teachers. *Computers & Education*, 67, 21–35. doi:10.1016/j.compedu.2013.02.010
- Bourgonjon, J., Valcke, M., Soetaert, R., & Schellens, T. (2010). Students' perceptions about the use of video games in the classroom. *Computers & Education*, 54(4), 1145–1156. doi:10.1016/j.compedu.2009.10.022
- Davis, F. D. (1989). Perceived Usefulness, Perceived Ease of Use, and User Acceptance of Information Technology. *MIS Quarterly*, 13(3), 319–340.
- Davis, F. D., Bagozzi, R. P., & Warshaw, P. R. (1989). User Acceptance of Computer Technology : A Comparison of Two Theoretical Models. *Management Science*, 35(8), 982–1003.
- Fishbein, M., & Ajzen, I. (1975). *Belief, Attitude, Intention, and Behavior: An Introduction to Theory and Research*. Reading, MA: Addison- Wesley.
- Hair, J. F., Black, W. C., Babin, B. J., & Anderson, R. E. (2010). *Multivariate Data Analysis* (7th ed.). New Jersey, USA: Pearson Prentice Hall.
- Ifenthaler, D., & Schweinbenz, V. (2013). The acceptance of Tablet-PCs in classroom instruction: The teachers' perspectives. *Computers in Human Behavior*, 29(3), 525–534. doi:10.1016/j.chb.2012.11.004
- Jazihan, M., Ahmad Fauzi, M. A., & Wong, S. L. (2012). Attitude towards Mobile Learning among Malaysian Higher Education Students: A Confirmatory Factor Analysis. In *20th International Conference on Computers in Education ICCE 2012* (pp. 127–133). Singapore: Asia-Pacific Society for Computers in Education.
- Jazihan, M., Ahmad Fauzi, M. A., & Wong, S. L. (2013). Factors influence the acceptance of m-Learning in Malaysia : Perceived Usefulness , Perceived Ease of Use and Attitude. In *21st International Conference on Computers in Education*. Indonesia: Asia-Pacific Society for Computers in Education.
- Liu, Y., Li, H., & Carlsson, C. (2010). Factors driving the adoption of m-learning: An empirical study. *Computers & Education*, 55(3), 1211–1219. doi:10.1016/j.compedu.2010.05.018
- Lou, H., Luo, W., & Strong, D. (2000). Perceived critical mass effect on groupware acceptance. *European Journal of Information Systems*, 9(2), 91–103. doi:10.1057/palgrave.ejis.3000358
- Ministry of Education. (2013). *Malaysian Education Blueprint 2013-2025*. Putrajaya.

- Mo, D., Swinnen, J., Zhang, L., Yi, H., Qu, Q., Boswell, M., & Rozelle, S. (2013). Can One-to-One Computing Narrow the Digital Divide and the Educational Gap in China? The Case of Beijing Migrant Schools. *World Development*, 46, 14–29. doi:10.1016/j.worlddev.2012.12.019
- Moses, P., Wong, S. L., Kamariah, A. B., & Rosnaini, M. (2013). Perceived Usefulness and Perceived Ease of Use: Antecedents of Attitude Towards Laptop Use Among Science and Mathematics Teachers in Malaysia. *The Asia-Pacific Education Researcher*. doi:10.1007/s40299-012-0054-9
- Roslina, I., Rasimah, C. M. Y., Khalili, K., & Azizah, J. (2011). Factors Affecting Undergraduates ' Acceptance of Educational Game : An Application of Technology Acceptance Model (TAM). *Proceedings of the Springer-Verlag Berlin Heidelberg 2011*, 135–146.
- Smet, C. De, Bourgonjon, J., Wever, B. De, Schellens, T., & Valcke, M. (2012). Researching instructional use and the technology acceptance of learning management systems by secondary school teachers. *Computers & Education*, 58(2), 688–696. doi:10.1016/j.compedu.2011.09.013
- Teo, T. (2009). Modelling technology acceptance in education: A study of pre-service teachers. *Computers & Education*, 52(2), 302–312. doi:10.1016/j.compedu.2008.08.006
- Teo, T. (2012). Modelling the Influences of Beliefs on Pre- Service Teachers ' Attitudes Towards Computer Use. *European Journal of Educational Research*, 3(1), 13–22.
- Teo, T., Lee, C. B., & Chai, C. S. (2007). Understanding pre-service teachers' computer attitudes: applying and extending the technology acceptance model. *Journal of Computer Assisted Learning*, 24(2), 128–143. doi:10.1111/j.1365-2729.2007.00247.x
- Wan Muhammad Amir, W. A., Nurfadhline, A. H., Nor Azlida, A., Norizan, M., Wan Abd Aziz, W. M. A., & Nur Amirah, A. (2013). Quantitative Analysis on the Level of Acceptance , Usage and Problems of E-books Among School Teachers in Terengganu. *The International Journal of Social Sciences*, 7(1), 89–101.
- Zuber, E. N., & Anderson, J. (2012). The initial response of secondary mathematics teachers to a one-to-one laptop program. *Mathematics Education Research Journal*, 25(2), 279–298.

Strategies for Improving Learning Performance by Using Crowdsourcing and Flipped Classroom

C.Y. YU*, Z.H. XU, G.L.CHEN & J.H. GUO

School of Computer and Information Engineering, Chuzhou University, China

*yuchy@chzu.edu.cn

xzh@chzu.edu.cn

glchen@chzu.edu.cn

jhguro@chzu.edu.cn

Abstract: We conducted a survey indicating the wide variety of computer literacy and computer skills among college students. Most teachers suggest that new teaching strategies should be deployed. To resolve these issues, we propose a strategy for improving learning performance in the Introduction to Computers class based on the concepts of crowdsourcing and flipped classroom. The design strategy attempts to resolve common issues in training teachers, designing teaching activities, and sharing knowledge and teaching experiences simultaneously. To accomplish the above goals, we make use of a crowdsourcing system which serves multiple purposes including (1) the innovation of teaching ideas; (2) the enhancement of instructor engagement and training process; and (3) the improvement of sharing knowledge and teaching experiences. To verify the proposed approach, an experiment involving over 10,000 students will be conducted.

Keywords: crowdsourcing, flipped classroom, MOOCs

1. Introduction

Although computers are popular in the current information era, not all students are able to take the full advantage of it. According to our survey, college students have a wide range of computer literacy and skills. Furthermore, most teachers suggest that new teaching strategies should be deployed. In this paper, we propose a strategy for improving learning performance in the Introduction to Computers class based on the concepts of crowdsourcing and flipped classroom in order to resolve these challenging issues.

Crowdsourcing was coined by J. Howe in 2006 [1]. Crowdsourcing systems enlist a multitude of humans to help solve a wide variety of problems. Prime examples include Wikipedia, Linux, Yahoo! Answers, and Mechanical Turk-based systems [2]. Strategies are known as crowd wisdom, crowd creation, crowd funding, and crowd voting [3]. However, applications of crowdsourcing are not only extensively used in general public domains, but also in the education field. In the web site of The Chronicle of Higher Education, examples and undergoing research projects in crowdsourcing can be found [4]. To implement crowdsourcing, open source and commercial platforms are available [5].

NY Times declared that 2012 is the year of MOOCs [6]. There are three MOOCs key players, Coursera, Udacity, and edX today. One of the key features in which a MOOC differs from traditional online classes is that MOOCs video clips are short (usually less than 15 minutes). The length of these videos take into consideration human cognition loading. With these video clips available, the concept of flipped classroom can be easily implemented. As a result, we integrate crowdsourcing and flipped classroom together to improve the learning performance. To verify the effectiveness of the design strategy, we also design an experiment involving over 10,000 participants. Data will be collected for further analysis from different dimensions.

2. Problem Statement and Design Strategy

In this section, we describe the survey and its results. In addition, we propose a corresponding strategy to resolve issues evident in the results of our survey.

2.1 Problem Statement

A survey is conducted to probe the computer literacy and skills of college freshmen. There are 10 items and five levels (not familiar to very familiar) for each category of computer skills. As shown in Figure 1, the survey indicates that the familiarity levels of students vary greatly. We also investigate what students expect to learn and what teachers think students should learn in the Introduction to Computers course. As shown in Figure 2 and Figure 3, the survey shows that the students' expectations and the teachers' opinions do not match well. It also indicates that the teachers' opinions are not unanimous. However, more than 70% of teachers suggest that the teaching strategy should be improved. Based on the survey mentioned above, we draw the following conclusions:

- (1) the course content and activities should be present in a variety of ways to better suit the students;
- (2) a mechanism that can enable teachers to generate ideas and share knowledge would be beneficial.

Topic	Option				
	Very Poor	Poor	Fair	Good	Very Good
(1) Typing in English and Chinese	22(4.1%)	105(19.59%)	198(36.94%)	142(26.49%)	69(12.87%)
(2) Software install and uninstall	56(10.45%)	100(18.66%)	115(21.46%)	170(31.72%)	95(17.72%)
(3) Use of Windows	56(10.45%)	117(21.83%)	159(29.66%)	144(26.87%)	60(11.19%)
(4) Use of Word	62(11.57%)	128(23.88%)	150(27.99%)	144(26.87%)	52(9.7%)
(5) Use of Excel	104(19.4%)	125(23.32%)	169(31.53%)	100(18.66%)	38(7.09%)
(6) Use of PowerPoint	122(22.76%)	132(24.63%)	157(29.29%)	92(17.16%)	33(6.16%)
(7) Deal with simple computer abnormality	191(35.63%)	178(33.21%)	101(18.84%)	44(8.21%)	22(4.1%)
(8) Simple image and audio editing	221(41.23%)	159(29.66%)	98(18.28%)	45(8.4%)	13(2.43%)
(9) Install operation system	312(58.21%)	112(20.9%)	68(12.69%)	32(5.97%)	12(2.24%)
(10) Computer programming	406(75.75%)	73(13.62%)	44(8.21%)	7(1.31%)	6(1.12%)

Figure 1. Computer skills of college freshmen vary greatly.

Option	Numbers	Percentage
A、 Office software	406	75.75%
B、 Install operation system , backup and recovery	332	61.94%
C、 Computer troubleshooting	349	65.11%
D、 Computer security	290	54.1%
E、 Common network access	218	40.67%
F、 Flash animation	314	58.58%
G、 Photoshop image editing	310	57.84%
H、 Utility Software	280	52.24%
I、 Multimedia Technology	321	59.89%
J、 Assembly and maintenance of computer	260	48.51%
K、 Installation and use of commonly used software	269	50.19%
L、 Database Technology	232	43.28%
M、 Video Editing	296	55.22%
Total	536	

Figure 2. Students' expectations of what they will learn in the Introduction to Computers course

Option	Percentage
Install operation system backup and recovery	68%
Computer troubleshooting	80%
Common network access	56%
Installation and use of commonly used software	68%
others	8%

Figure 3. Teachers' viewpoints: Course contents that should be enhanced differ among teachers

2.2 Strategy for improving learning performance

We propose the following strategy to resolve the challenging issues mentioned in Section 2.1. The main concept is depicted in Figure 4. It consists of four main mechanisms: MOOCs videos, idea generation, flipped classroom, and performance evaluation. First, we prepare videos in MOOCs format for students to learn course materials and discuss with classmates online. Second, instructors work together in a crowdsourcing system to generate teaching ideas and design suitable class activities for students. Third, we conduct flipped classroom in class. Fourth, the corresponding data will be collected to perform further analysis to improve the design. The preparation of MOOC videos will be executed in a consistent manner. Our focal points are the crowdsourcing system and performance evaluation, which we will elaborate in more detail in Section 3.

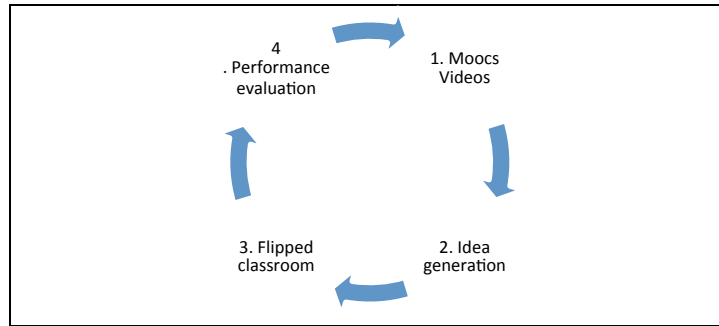

Figure 4. Strategy which includes four mechanisms to resolve challenging issues in the Introduction to Computers course

3. System Overview and Crowdsourcing System

3.1 Framework of the System

Let us consider several common challenges with teaching on-site at many educational institutions: (1) how to execute instructor training; (2) how to share teaching and learning experiences; and (3) how to do teaching evaluation. In this section, we propose strategies to simultaneously resolve the above issues. In the realm of learning, co-construction is an approach whereby the emphasis is in working collaboratively or in partnerships. 'Co-construction of learning' deepens relationships and understanding between all learning partners and can lead to improvements in the quality of education (Wikipedia, 2013). The designed system targets co-construction between instructors and instructional designers. The corresponding design philosophy and framework of the system are described in this section.

First, the instructors and/or instructional designers that will engage in the course design and lecture delivery are invited to be the participants of co-construction. Participant requirements include familiarity in relevant areas such as (1) pedagogic design; (2) course content; and (3) lecture delivery. The design philosophy, as shown in Figure 5, is based on the funnel of content creation, which is inspired by the 'marketing funnel', an idea in widespread use in marketing and sales (D. Clow, 2013). By way of analogy, we have four stages in our design framework:

- Awareness – instructors understand the target material and task (e.g., specific chapter, section, or knowledge node);
- Acquisition – instructors enhance teaching activities by query, peer discussion, and any knowledge acquisition processes;
- Action – instructors create their learning activities or modify other instructors' inputs, i.e., an ideation step;
- Consequence – the leader of the activity designers terminates the design process and concludes with final results.

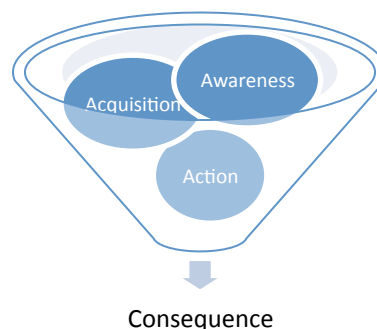

Figure 5. The funnel of idea generation

In order to implement the design philosophy mentioned above, four mechanisms are designed. We elaborate each mechanism in detail as follows.

- **Awareness: Mechanism of participant invitation and task awareness**
Materials of benefit to participants are provided to orientate themselves. This consists of functions such as an invitation to the participants, a description of the lecture, a description of the lecture format and style, an announcement and confirmation, a guided procedure with templates and tools to help keep track of the task, a best practice guide and tutorials, and a record of the participants' usage.
- **Acquisition: Mechanism of co-construction of learning activities**
The co-construction of learning activities is executed in this mechanism. It includes reading and offering comments and suggestions on the lecture content, designing learning activities, and selecting the preferred content and learning activities. This process is a knowledge generation and filtering preparation phase.
- **Action & Consequence: Mechanism of lecture accomplishment**
Knowledge filtering and sharing occurs in this mechanism. At the appropriate time, the leader of the co-construction concludes with the final result and produces the top-ranked learning activities. Subsequently, he/she informs all participants of these activities.
- **Feedback: Mechanism of outcome evaluation and analysis**
The feedback mechanism collects information related to instructor class experience, learners' assessment and survey, etc. to improve the co-construction mechanisms as well as lecture content and pedagogy design.

In order to ensure the quality of outcome, being able to smoothly transition between stages is also important. For instance, participants are not allowed to begin the acquisition stage before they complete the awareness stage. Based on the above description, the corresponding learning platform and tools will be supported in the implementation phase. Meanwhile, encouragement policies for participation will be designed.

4. Experimental Design

To validate the above design, a common course "Introduction to Computers" is selected. Four schools and over 100 instructors and 10,000 students will join the pilot study.

4.1 Syllabus

"Introduction to Computers" (G. L. Chen, 2009), the selected textbook, consists of 12 chapters and labs. Each chapter will be transformed into MOOCs format and includes text, videos, quizzes, discussion, and learning activities (Coursera, 2013). Instructional designers first divide each chapter into suitable knowledge nodes. The video length of each knowledge node is around 10 minutes. Instructors are asked to contribute in quizzes, discussion topics, and learning activity design tasks by following the designed format described in the co-construction management system.

4.2 Class Type

To gain a better understanding of learners' behaviors and their learning results, we arrange four types of learning classes for the experiment. Note that the size of each class may not be equal.

- **Class Type A: online classroom only**
Students only take classes and read learning materials online
- **Class Type B: flipped classroom**
Students attend classes on-site in the classroom and read learning materials online
- **Class Type C: regular classroom**
Students attend classes on-site and are encouraged to read the learning materials online
- **Class Type D: open online class**
Students attend classes on-site and gain free access to the learning materials online.

The lecture content and learning activities on the web will be available on a MOOC platform, the digital learning environment for all students and instructors. Meanwhile, instructors will be asked to access the lecture content co-construction management system to record and report the processes.

4.3 Data Acquisition

Data and survey from different dimensions, such as stakeholders, instruments, and objectives will be collected to perform further analysis. These data collections are mainly from MOOCs platform and lecture content co-construction management system. In each lecture unit, data collected include, but are not limited to, the following:

- Students: ePortfolio, log file data, assessment (formative and summative), resource utilization, discussion board action, learning outcomes.
- Teachers: log files data, engagement, content contribution, idea generation and sharing, feedback.

4.4 Data Analysis and Information Flow

Although the data collected can be applied to different research objectives, the main focal points of our evaluation are co-construction strategy and mechanisms. The learning analytics mechanism takes inputs from MOOCs platform and co-construction management, and its outputs are of benefit to the areas of pedagogy, research, and administration.

5. Conclusion and Future Work

A strategy to improve student learning performance in the Introduction to Computers is proposed in this paper. By using the crowdsourcing system, we expect the instructors to gain knowledge and familiarity in the lecture content and learning activities. As a result, it may reduce the load of preparing for class for the instructor and improve the quality of their teaching. The above goals will be verified via the designed experiment involving more than 10,000 learners. Data collected from MOOCs platform and co-construction system will be analyzed.

This is a pilot program. The experience and results obtained will be conducive to the enhancement of the co-construction system as well as the improvement of teaching and learning. It also paves the way to design more MOOC lectures effectively.

References

- [1] Howe, J. (2006). The rise of crowdsourcing. *Wired magazine*, 14(6), 1-4.
- [2] Doan, A., Ramakrishnan, R., & Halevy, A. Y. (2011). Crowdsourcing systems on the world-wide web. *Communications of the ACM*, 54(4), 86-96.
- [3] Solemon, B., Ariffin, I., Din, M. M., & Anwar, R. M. (2013). A Review of the Uses of Crowdsourcing in Higher Education. *International Journal of Asian Social Science*, 3(9), 2066-2073.
- [4] The chronicle of higher education. Retrieved April 21, 2014, from <http://chronicle.com/>.
- [5] Yuen, M. C., King, I., & Leung, K. S. (2011, October). A survey of crowdsourcing systems. In *Privacy, security, risk and trust (passat), 2011 IEEE third international conference on and 2011 IEEE third international conference on social computing (socialcom)* (pp. 766-773). IEEE
- [6] Pappano, L. (2012). The Year of the MOOC. *The New York Times*, 2(12), 2012.
- [7] Clow, D. (2013, April). MOOCs and the funnel of participation. In *Proceedings of the Third International Conference on Learning Analytics and Knowledge*(pp. 185-189). ACM.
- [8] G. L. Chen(2013). *Introduction to Computers*. (in Chinese) Tsinghua Press.
- [9] Coursera(2014). Retrieved March 4, 2014, from <https://www.coursera.org/>
- [10] Wikipedia (2014). Retrieved April 19, 2014, from <http://en.wikipedia.org/wiki/Co-construction>

Students' conceptions of and approaches to knowledge building: A phenomenographic method

Pei-Shan TSAI^{a*}, Ching Sing CHAI^b, Joyce Hwee Ling KOH^b, Nurul Huda MUHAMAD JAILANT^c,
& Angela Lay Hong KOH^c

^a*Center for Teacher Education & Institute of Education, National Sun Yat-sen University, Taiwan*

^b*National Institute of Education, Nanyang Technological University, Singapore*

^c*Nan Chiau Primary School, Singapore*

*sandra.pstsai@gmail.com

Abstract: This study explored primary school students' conceptions of and approaches to knowledge building using a phenomenographic method. A total of 48 students participated in present study. Five qualitative conceptions of knowledge building, namely "building up knowledge," "sharing ideas," "obtaining ideas," "discussing ideas" and "improving ideas," and five approaches to knowledge building, namely "seeking for the related information," "contributing what I know," "receiving more ideas," "discussing ideas for better understanding" "getting feedback for making ideas refined" were revealed. These different and hierarchically related categories show the perspectives as experienced by the students. The results indicated that the students with fragmented conceptions tended to use surface approaches while those with cohesive conceptions tended to adopt deep approaches.

Keywords: Conceptions of learning, approaches to learning, knowledge building

1. Introduction

Within the computer-supported collaborative learning (CSCL) literature, knowledge building has received much attention in recent decades. It describes how students can be engaged with online discourse to develop new knowledge within a community through the use of discussion forums, mainly the Knowledge Forum (Chan, 2011). Scardamalia & Bereiter (2010) distinguish between knowledge building and learning; they see learning as "a personal matter, but knowledge building is done for the benefit of the community." (p.2). Knowledge building highlights the creation and modification of ideas as public knowledge that lives 'in the world', and can be further improved by other people. Based on the extensive research conducted on the knowledge building pedagogy, Scardamalia (2002) has distilled twelve principles or social-cognitive and technological contributing factors that are essential for fostering a knowledge building culture in a classroom. These principles, include (a) real ideas, authentic problems, (b) improve ideas, (c) idea diversity, (d) rise above, (e) epistemic agency, (f) community knowledge, collective responsibility, (g) democratizing knowledge, (h) symmetric knowledge advancement, (i) pervasive knowledge building, (j) constructive uses of authoritative sources, (k) knowledge building discourse, and (l) embedded and transformative assessment. Essentially, these principles engage students in addressing problems of understanding they are personally confronted with, articulating their initial understanding as ideas and subsequently treating the ideas as improvable cognitive artifacts. The students assume the responsibilities as a community to respectfully examine the diverse ideas proposed through collaborative discourse that aims to improve their collective understanding. The ideas are therefore discussed and compared to authoritative sources and sometimes empirical testing, and are assessed and sometimes transformed as higher level cognitive artifacts. These principles not only guide teachers and researchers to design their lesson activities and teaching strategies, but also to evaluate the extent of knowledge advancement within the community (Hong & Scardamalia, 2014).

Recently, a growing body of research has investigated students' conceptions of and approaches to learning in educational research, such as conceptions of and approaches to learning through peer assessment (Yang & Tsai, 2010), conceptions of and approaches to learning through online discussion (Ellis, Goodyear, Prosser, & O'Hara, 2006), conceptions of learning management (Lin & Tsai, 2011), and conceptions of and approaches to online argumentation (Tsai & Tsai, 2013). Conceptions of learning are related to what the students think about the learning process and its purposes (Benson & Lor, 1999) while approaches to learning are concerned with how students approach their learning (Yang & Tsai, 2010). In this line of research, phenomenographic method was utilized to explore individual variations in the perceptions of the phenomenon experienced by the students. The phenomenographic method is a qualitative method, and is used to document individual experiences and classify the variations into hierarchically related categories (Åkerlind, 2005; Richardson, 1999). For example, in the pioneering study of Säljö (1979), five qualitatively different, hierarchically related conceptions were revealed, including "increase of knowledge," "memorizing," "acquiring facts or procedures that can be retained and/or utilized in practice," "abstraction of meaning," and "an interpretative process aimed at the understanding of reality." Hence, following this research method, the hierarchically related conceptions and approaches were found, and also revealed students' different views of learning that have implications for improving how teachers design and practice their instruction.

Moreover, many researchers have categorized conceptions of learning as fragmented and cohesive conceptions (Ellis et al., 2006). Fragmented conceptions refer to a limited understanding of the learning resources and environment where students fail to take advantage of it while cohesive conceptions refer to a comprehensive understanding of the learning resources and environment that students can leverage to enhance their learning. Ellis et al. (2006) revealed that students with cohesive conceptions tend to have better learning outcomes than those with fragmented conceptions. Likewise, approaches to learning can be classified into surface and deep approaches (Yang & Tsai, 2010). Surface approaches reveal that students engage in the learning activity for reproduction. Deep approaches reveal that students engage in the learning activity for real understanding. Unsurprisingly, Ellis, Goodyear, Brilliant and Prosser (2008) indicated that students with deep approaches tend to outperform than those with surface approaches.

By using dichotomous views (i.e. fragmented versus cohesive conceptions, and surface versus deep approaches), many studies found the positive relationships between students' conceptions of and approaches to learning (Lee, Johanson, & Tsai, 2008). For example, Yang and Tsai (2010) revealed that the college students who held fragmented conceptions of learning through peer assessment tended to adopt surface approaches while those who held cohesive conceptions tended to use deep approaches. The results of these studies implied that students' conceptions of and approaches to learning may be important for their learning. In the present study, we are interested in investigating how students developed their conceptions of and approaches to knowledge building after engaging in knowledge building as a community in a social study class. Therefore, the present study aimed to examine students' conceptions of and approaches to knowledge building. The research questions are showed as below:

- Using the phenomenographic method, what are the students' conceptions of knowledge building?
- Using the phenomenographic method, what are the students' approaches to knowledge building?
- What are the relationships between students' conceptions of and approaches to knowledge building?

2. Method

2.1 Participants

The participants of this study consisted of 48 primary school students ranging in age from 9 to 11 years (consisted of 23 primary three and 25 primary four students; 19 females and 29 males). All of the students had experienced knowledge building activities in social studies classes for one year (a 35-minute period weekly). The curriculum plan of the primary three and four social studies is to enhance civic-mindedness among students through an understanding of Singapore's past and present. In

the knowledge building activities, students were encouraged to interact and discuss the issues with their peers online by using the Knowledge Forum™.

2.2 Data collection and analysis

To understand the students' conceptions of and approaches to knowledge building, the interview questions were constructed based on Tsai (2009), Yang and Tsai (2010), and shown as below.

- What were the knowledge building activities about? Please share with me your experiences last year.
- Based on your experience, what do you think is the meaning of knowledge building activities?
- When your friends, who did not attend the knowledge building activities, ask you about the knowledge building activities, what will you tell them?
- What do you think about the purpose of knowledge building activities?
- Given a choice, would you still want to take part in knowledge building activities?

Why?

- What have you done during knowledge building activities?
- What strategies did you use and why did you adopt those strategies in the knowledge building activities?
- What were some of the things you learnt from the knowledge building activities?
- How do you know when you have learned something through knowledge building activities?

The first five questions explored the students' conceptions of knowledge building, while the rest investigated the students' approaches to knowledge building. Moreover, the phenomenographic method (Richardson, 1999) and the most dominant category (Koballa, Gaber, Coleman & Kemp, 2000; Tsai & Kao, 2008) were utilized to analyze the students' interview responses, which were applied as a major data source to examine their conceptions of and approaches to knowledge building.

Firstly, this study utilized the phenomenographic method to identify qualitatively different categories for describing students' conceptions of and approaches to knowledge building. That is, the authors read the whole interview responses, chose the significant sentences, and then marked the main ideas which were able to represent the students' conceptions of and approaches to knowledge building. The authors also compared the significant sentences and the marked ideas to find out the similarities and differences between the students' responses. The hierarchically related categories of students' conceptions of and approaches to knowledge building were then constructed in this study.

Similar to previous studies (Koballa et al., 2000; Tsai & Kao, 2008), this study also found that the students had mix views of conceptions and approaches; hence, following the most dominant category, the authors identified each student's highest frequency idea as the most significant conception and approach to represent his/her views of knowledge building. For instance, Tsai and Tsai (2014) revealed four categories of college students' conceptions of online argumentation, involving expressing ideas, discussing ideas, negotiating ideas, and reflecting on and extending ideas. If a student had many utterances around "discussing ideas" but a few utterances about "negotiating ideas," these utterances would be grouped into the category of "discussing ideas."

After the classification of interview responses, 20 out of all students were randomly chosen and their interview responses were classified by another author using the same coding criteria. The percentage of agreement was applied to measure the reliability of the two researchers' coding. The percentage of agreement with regard to the conceptions and approaches were 80% and 85%, respectively. For the remaining data that were not subjected to inter-rating, the researchers reviewed and discussed the interview responses together, and then determined final classifications.

3. Findings

3.1 Conceptions of knowledge building

Five different conceptions of knowledge building were identified by using the phenomenographic method. The categories range from A (highly fragmented conception) to E (highly cohesive conception) showing the hierarchically different conceptions of knowledge building as experienced by the students.

A. *Knowledge building as a way of building up knowledge.* Students conceptualized knowledge building as gaining and accumulating more knowledge from Internet. The purpose of knowledge building was to find more information about the theme under study.

B. *Knowledge building as a way of sharing ideas.* Students characterized knowledge building as a way of sharing ideas and information on Knowledge Forum. The purpose of knowledge building was to express and share their views.

C. *Knowledge building as a way of obtaining ideas.* Understanding classmates' ideas about the theme inquired was viewed as the main features of knowledge building. The purpose of knowledge building was to know others' perspectives.

D. *Knowledge building as a way of discussing ideas.* Trying to integrate and discuss the peers' ideas was viewed as the major features of knowledge building. Hence, students classified in this category not only shared information, but also the higher-level cognitive processes needed in knowledge building activities.

E. *Knowledge building as a way of improving ideas.* Knowledge building was characterized in terms of improving ideas. The purpose of knowledge building was the improvements of ideas or obtaining more complete understanding of a theme.

3.2 Approaches to knowledge building

Five qualitatively different approaches to knowledge building were identified by using the phenomenographic method. The categories from A, which is related to a highly surface approach, to E, which is related to a highly deep approach, reveal hierarchically different approaches to knowledge building as experienced by the students.

A. *Engaging in knowledge building to seek for the related information.* This approach to knowledge building highlighted seeking for the related information about the theme from the Internet. The students tended to emphasize information finding is a necessary process in knowledge building activities.

B. *Engaging in knowledge building to contribute what I know.* This approach to knowledge building stressed providing more ideas. The students seemed to expect that they could tell more ideas they known.

C. *Engaging in knowledge building to receive more ideas.* This approach highlighted providing their opinions to receive more ideas. The students seemed to expect that they could get more feedback from peers.

D. *Engaging in knowledge building to discuss ideas for better understanding.* This approach to knowledge building stressed discussing with peers to increase their understanding about a theme.

E. *Engaging in knowledge building to get feedback for making ideas refined.* This approach to knowledge building emphasized discussing with peers to re-think or reflect on their ideas in a more cohesive way. The students seemed to expect that they could refine their ideas.

3.3 The distribution of students' conceptions of and approaches to knowledge building

The distribution of variation in conceptions of and approaches to knowledge building are shown in Table 1. As to student' conceptions, 68.7% (n = 33) of interview responses were classified as fragmented, and 31.3% (n = 15) as cohesive. As to students' approaches, 72.9% (n = 35) of interview responses were classified as surface, and 27.1% (n = 13) as deep. It implies that most students were viewing knowledge building in a fragmented way and used a surface approach.

Table 1: The distribution of students' conceptions of and approaches to knowledge building.

Type	Category	Counts
------	----------	--------

<i>Conceptions of knowledge building</i>		
Fragmented	A	16 (33.3%)
	B	7 (14.6%)
	C	10 (20.8%)
Cohesive	D	9 (18.8%)
	E	6 (12.5%)
<i>Approaches to knowledge building</i>		
Surface	A	18 (37.5%)
	B	7 (14.6%)
	C	10 (20.8%)
Deep	D	8 (16.7%)
	E	5 (10.4%)

3.4 The relations between students' conceptions of and approaches to knowledge building

To explore the relations between conceptions of and approaches to knowledge building, the Pearson chi-square test was conducted in this study. As shown in Table 2, the results showed that there was a significant relations between students' conceptions of and approaches to knowledge building ($\chi^2 (1, n = 48) = 21.86, p < 0.001$). It implies that students with fragmented conceptions tend to use surface approaches, while those with cohesive conceptions tended to use deep approaches.

Table 2: The relations between students' conceptions of and approaches to knowledge building.

Approaches/Conceptions	Fragmented	Cohesive
Surface	29	5
Deep	2	12
$\chi^2 (1, n = 48) = 21.86, p < 0.001$		

4. Discussion and conclusions

This study investigated students' conceptions of and approaches to knowledge building by using the phenomenographic method. Five qualitative conceptions of knowledge building, namely "building up knowledge," "sharing ideas," "obtaining ideas," "discussing ideas" and "improving ideas," and five approaches to knowledge building, namely "seeking for the related information," "contributing what I know," "receiving more ideas," "discussing ideas for better understanding" "getting feedback for making ideas refined" were revealed. These different and hierarchically related categories show the perspectives as experienced by the students.

Our findings showed that in accordance with the fragmented and cohesive conceptions, more than half of the students held fragmented conceptions (i.e. building up knowledge, sharing ideas and obtaining ideas). Similarly, according to the surface and deep approaches, more than half of the students held surface approaches (seeking for the related information, contributing what I know, and receiving more ideas). Moreover, this study also found that students' conceptions are related to their approaches; that is, students with fragmented conceptions tended to use surface approaches while students with cohesive conceptions tended to adopt deep approaches. The results are consistent with the studies of Bliuc, Ellis, Goodyear and Piggott (2011), and Yang and Tsai (2010). The findings extended current research of conception of learning and points out that the deep and surface continuum is applicable to conception of knowledge building and there is a need to pay attention to the less desirable conceptions that have been formed.

Many researchers have investigated the relationships among students' experiences of learning and the learning outcomes, including the relationships among conceptions of online argumentation, and the quality of online argumentation (Tsai & Tsai, 2014), and the relationships among conceptions of learning via peer assessment, approaches to learning via peer assessment and learning outcomes (Yang & Tsai, 2010). Those studies provided some insights into students' learning processes from students' views. Therefore, future studies are encouraged to examine the relationships between students' perceptions of knowledge building and their knowledge building processes.

Acknowledgements

This study was funded by the research grant NRF2011-EDU002-EL005.

References

- Åkerlind, G. (2005). Variation and commonality in phenomenographic research methods. *Higher Education Research & Development, 24*, 321-334.
- Benson, P., & Lor, W. (1999). Conceptions of language and language learning. *System, 27*, 459-472.
- Bliuc, A. M., Ellis, R. A., Goodyear, P., & Piggott, L. (2011). A blended learning approach to teaching foreign policy: Student experiences of learning through face-to-face and online discussion and their relationship to academic performance. *Computers & Education, 56*(3), 856-864.
- Chan, C. K. K., & Chan, Y. Y. (2011). Students' views of collaboration and online participation in Knowledge Forum. *Computers & Education, 57*, 1445-1457.
- Ellis, R. A., Goodyear, P., Prosser, M., & O'Hara, A. (2006). How and what university students learn through online and face-to-face discussion: Conceptions, intentions and approaches. *Journal of Computer Assisted Learning, 22*(4), 244-256.
- Ellis, R. A., Goodyear, P., Brilliant, M., & Prosser, M. (2008). Student experiences of problem-based learning in pharmacy: conceptions of learning, approaches to learning and the integration of face-to-face and on-line activities. *Advances in Health Sciences Education, 13*, 675-692.
- Hong, H. Y. & Scardamalia, M. (2014). Community knowledge assessment in a knowledge building environment. *Computers & Education, 71*, 279-288.
- Koballa, T., Graber, W., Coleman, D. C., & Kemp, A. C. (2000). Prospective gymnasium teachers' conceptions of chemistry learning and teaching. *International Journal of Science Education, 22*(2), 209-224.
- Lee, M. H., Johanson, R. E., & Tsai, C. C. (2008). Exploring Taiwanese high school students' conceptions of and approaches to learning science through a structural equation modeling analysis. *Science Education, 92*(2), 191-220.
- Lin, H. M., & Tsai, C. C. (2011). College students' conceptions of learning management: The difference between traditional (face-to-face) instruction and Web-based learning environments. *Learning, Media and Technology, 36*(4), 437-452.
- Richardson, J. T. E. (1999). The concepts and methods of phenomenographic research. *Review of Educational Research, 69*(1), 53-82.
- Säljö, R. (1979). Learning in the learner's perspective, 1: Some commonsense conceptions. Gothenburg, Sweden: Institute of Education, University of Gothenburg.
- Scardamalia, M. (2002) Collective Cognitive Responsibility for the Advancement of Knowledge. B.Simth (Ed.) Liberal Education in a Knowledge Society. Chicago, Open Court.
- Scardamalia, M., & Bereiter, C. (2010). A Brief History of Knowledge Building. *Canadian Journal of Learning and Technology, 36*(1).
- Tsai, C. C. (2009). Conceptions of learning versus conceptions of web-based learning: The differences revealed by college students. *Computers & Education, 53*(4), 1092-1103.
- Tsai, C. C., & Kuo, P. C. (2008). Cram school students' conceptions of learning and learning science in Taiwan. *International Journal of Science Education, 30*(3), 353-375.
- Tsai, P. S., & Tsai, C. C. (2013). College students' experience of online argumentation: conceptions, approaches and the conditions of using question prompts. *The Internet and Higher Education, 17*, 38-47.
- Tsai, P. S., & Tsai, C. C. (2014). College students' skills of online argumentation: the role of scaffolding and their conceptions. *The Internet and Higher Education, 21*, 1-8.
- Yang, Y. F., & Tsai, C. C. (2010). Conceptions of and approaches to learning through online peer assessment. *Learning and Instruction, 20*(1), 72-83.
- Zhang, J., Scardamalia, M., Reeve, R., & Messina, R. (2009). Designs for collective cognitive responsibility in knowledge-building communities. *Journal of the Learning Sciences, 18*(1), 7-44.

Influence of ICT-Supported Learning Environment Perceptions, Academic Ability, and Prior Educational Experience on Approaches to Learning for Accounting in Malaysian Secondary Schools

Boon See TAN^{a*} & Su Luan WONG^b

^a*Faculty of Educational Studies, Universiti Putra Malaysia, Malaysia*

^b*Faculty of Educational Studies, Universiti Putra Malaysia, Malaysia*

*bstan_29@yahoo.com

Abstract: This study reviews selected influencing factors on students' approaches to learning for accounting in the ICT-supported learning environment, namely the students' perceptions of learning environment, academic ability, and prior educational experience. The retrieved research reports reveal that the learning environment which is perceived as being tensed up with pressure and demands would influence students to adopt surface approaches to learning. However, the ICT-supported learning environment that contributed to the perceptions of interactivity and involvement, inquiry and investigation, authenticity of learning, cooperation, and differentiation would stimulate deep approach to learning. Furthermore, academic ability could positively or negatively influence approaches to learning. Lastly, the availability and quality of prior educational experience could influence deep approach to learning, while problematic prior educational experience would lead to surface approach to learning.

Keywords: Deep approach to learning, surface approach to learning, perceptions of ICT-supported learning environment, academic ability, prior educational experience, accounting

1. Introduction

Accounting is one of the important professions for nation building which covers a wide spectrum of economic events in business enterprise and national economic activities. However, accounting is always regarded as a technical-oriented subject and it has been dominated by the objective of training students to know facts and solve problems from a narrow and inadequate perspective and thus, students used to take a surface approach to learning (Eley, 1992; Booth, Lockett, & Mladenovic, 1999; Lucas, 2000).

Likewise, in the context of Malaysia, the learning of accounting has yet to achieve deep approach, particularly at the level of fundamental accounting in secondary schools. It was found that most of the accounting teachers tended to focus on the procedural aspect of the subject by using the teacher-centred teaching approach without delving deeper into the knowledge (Suhaida Abdul Kadir, 2002; Hanuni Yusuf, 2003; Rohaila Yusof, 2006). This may be a reflection of the education system which has overemphasised students' academic achievement (Kementerian Pelajaran Malaysia [Ministry of Education], 2006) and many teachers are unwilling to take the risk of students' failure in examination by attempting innovative teaching. They would rather employ teacher-centred teaching methods which comply with the requirements of the exam-oriented education system. Moreover, students are short of the ICT skills to adopt deep approach to learning for managing the whole set of accounts by relating the processes of accounting cycle into a coherent whole (Arfah Salleh, 2001; Rashidah Hassan & Arfah Salleh, 2008; Tan & Wong, 2012).

In view of the weaknesses of the accounting education, a revised curriculum and assessment was launched by Ministry of Education in 2010. It involves consolidating the fundamental accounting

education by emphasising on the use of ICT skills for preparing a full set of accounts, soft skills, and ethical aspects of the accounting profession (Bahagian Pembangunan Kurikulum [Curriculum Development Section], 2009). However, to what extent the revised curriculum and assessment are able to foster students' deep approaches to learning, particularly under the ICT-supported learning context? Thus, in this review study, it is set forth to uncover the factors that may contribute to students' approaches to learning so that important information can be acquired for applying technology-enhanced pedagogy for better teaching and learning of accounting in Malaysian secondary schools.

1.1 Students' Approaches to Learning (SAL)

SAL is defined as the ways in which how a student perceived a particular academic task and then handle it (Marton & Säljö, 1976). In addition, SAL is seen as a contextually dependent response rather than an enduring characteristic of the individual (Meyer, Parsons, & Dunne, 1990). It is further identified into two contrasting approaches i.e. deep approach and surface approach. A deep approach entails learners' intrinsic motivation and interest to attempt to understand the meaning of the learning material and relate parts to each other, new ideas to previous knowledge or to personal meaningful context; whereas a surface approach is characterised by extrinsic motivation to acquire only sufficient knowledge to complete the task or pass the subject and thus, learners tend to memorise separate facts and/or view a particular task in isolation from other tasks and real life as a whole (Marton & Säljö, 1976; Biggs, 1985; 1987; Biggs and Moore, 1993; Biggs, Kember, & Leung, 2001; Kember, Biggs, & Leung, 2004).

1.2 Factors Influencing Approaches to Learning

Based on the Presage-Process-Product (3Ps) Model proposed by Biggs (1985) which explains why students learn and act differently in their processes of learning by delineating the important stages in learning i.e. Presage, Process, and Product, the author proposed that students' personal and situational factors which exist at the presage stage of learning or before learning takes place influence the learning process which is represented by learning approaches. In this vein, students' personal factors include their individual characteristics in terms of prior knowledge for a learning subject, abilities, personality, and home background; while situational factors of learning environment consists of the variables such as subject area, teaching method, time on task, task demand, and course structure. Furthermore, Ramsden (2003) adapted the 3Ps model by highlighting students' perceptions of learning environment which exist as an important presage factor to influence approaches to learning. In other words, it is not the learning environment in itself that influences learning, but the way students perceive it. As a consequence, several factors were selected for investigation and the research questions addressed in this review study are:

- Do students' perceptions of ICT-supported learning environment significantly influence approaches to learning?
- Does academic ability significantly influence approaches to learning?
- Does prior educational experience significantly influence approaches to learning?

2. Methodology

To answer the aforementioned research questions, studies that investigated the influence of ICT-supported learning environment with specific focus on examining the relationship between students' perceptions of learning environment, academic ability, and prior educational experience on students' approaches to learning were explored. The search terms were "approaches to learning", "ICT-supported learning environment", "constructivist learning environment", "student-centred learning environment" combined with key words of "perceptions", "academic ability", "student at risk", "prior educational experience", or "prior knowledge". For the acquisition of the articles related to accounting education, additional keywords were entered i.e. "accounting", "accounting education", "accounting learning", and "accounting teaching".

This literature search was conducted by means of the electronic search through several wellknown and established databases such as Taylor & Francis, Emerald Management Xtra Plus, Sage

Journals Online, SpringerLink, Wiley-Blackwell, and Science Direct. The abstracts of the studies were reviewed and the selected literatures were based on several criteria i.e. (1) the studies had to address students' approaches to learning consisting of motive and strategy to tackle a task; (2) the studies had to clearly address the relationships between the influencing factors (i.e. students' perceptions of learning environment, academic ability, and prior educational experience) and approaches to learning; and (3) the studies had to use computer or internet technologies for teaching and learning.

3. Results

3.1 Do Students' Perceptions of ICT-Supported Learning Environment Significantly Influence Approaches to Learning?

There have been many studies reporting that significant relationships exist between students' perceptions of learning context and approaches to learning. It was found that approaches to learning are influenced by different perceptions of students studying different subject areas (Ramsden, 1979). In this vein, accounting students were especially influenced by their learning context which perceived as being tensed up with pressure and demands from the professional accounting bodies and there was evidence that most of them adopt the surface approaches to learning (Eley, 1992; Gow, Kember, & Cooper, 1994; Sharma, 1997; Booth et al., 1999; Jackling, 2005; Lord & Robertson, 2006; Abraham 2006). On the other hand, deep approach to learning was found to be associated with perceived quality teaching support (Eley, 1992; Chan & Watkins, 1994; Lizzio, Wilson, & Simons, 2002), appropriate pedagogy which encourages independence, interaction, and inquiry (Eley, 1992; Abraham, 2006), and appropriate assessment (Abraham, 2006; Watty, Jackson, & Yu, 2010).

Furthermore, the ICT-supported learning environment is especially contributing to students' perceptions of interactivity and involvement (Maor, 2000; Law, Lee, & Chow, 2002; de Lange, Suwardy, & Mavondo, 2003; Jebeile & Abeysekera, 2010; Premuroso, Tong, & Beed, 2011), inquiry and investigation (Basu & Cohen, 1994; Siragusa, 2002; Jones, Scanlon, Gaved, Blake, Collins, Clough et al., 2013), authenticity of learning (Basu & Cohen, 1994; Green, Reinstein, & Mc Williams, 2000; Murphy & Hoepfner, 2002; Marriott, 2004; Stanley & Edwards, 2005; Neal 2005), cooperation (Rumpagaporn, 2007), and differentiation (Jebeile & Abeysekera; 2010) as well as the perceptions of teacher support (Rumpagaporn, 2007; Lillie & Wygal, 2011). These perceptions were found contributing to students' deep approaches to learning. Meanwhile, the ICT-supported learning environment perceived by students to have replaced them by producing the accounting reports automatically (Green et al., 2000) and being a safety net for absence (Wells, de Lange, & Fieger, 2008) were associated to surface approaches to learning.

3.2 Does Academic Ability Significantly Influence Approaches to Learning?

Academic ability refers to a person's capacity to study which is measured by his or her prior performance in examinations (Auyeung & Sands, 1994; Lizzio et al., 2002, Duff, 2004). Several studies reveal that students with low academic abilities were associated to surface approaches to learning and conversely, those with high academic abilities tended to perform deep approaches to learning (Holschuh, 2000; Duff, 2004; Tang, 2008). In addition, the low academic ability in terms of English competency was related to surface approach to learning (Gow et al., 1994; Kember, Ng, Tse, Wong, & Pomfret, 1996; Kember & Leung, 1998; Watty et al., 2010). This phenomenon was explained by the authors that due to the students' limited ability to decipher text written in English, they were likely to adopt surface strategy of memorising key words.

On the other hand, Lizzio et al. (2002) revealed that students with higher academic ability tended to use surface approach. This in particular applied to commerce students while the researchers found that science students demonstrated positive influence of academic ability to deep approaches to learning. Finally, Auyeung and Sand (1994) found that academic ability was only related to surface approach to learning. Overall, the past studies prove that academic ability is significantly related to surface or deep approach to learning.

3.3 Does Prior Educational Experience Significantly Influence Approaches to Learning?

A student's prior educational experience refers to a person's previous experiences of educational settings (Ramsden, 2003; Biggs, 2003). It provides prior knowledge before entering any actual learning context, which is important in determining learning. Many studies reveal that prior educational experience is related to approaches to learning. Most of the studies stress that availability of prior educational experience can influence deep approach to learning vice versa (Ramsden, 1979; Richardson, Morgan, & Woodley, 1999; Tempone, 2001; Dochy, De Rijdt, & Dyck, 2002; Harmer, 2009). Abhayawansa, Tempone, and Pillay (2012), on the other hand, focus on the quality of prior educational experience based on different learning environments i.e. students from conventional and technical schools. In this vein, learning environment which emphasises on the development of adaptability, innovativeness, and problem-solving was most likely to influence deep approach to learning. Furthermore, some of the studies focus on the negative aspect of prior educational experience. These studies highlighted that the problematic prior knowledge would lead to surface approach to learning (Crawford, Gordon, Nicholas, & Prosser, 1998; Lucas, 2000; 2001; McGowen & Tall, 2010).

4. Conclusion

Based on the aforesaid studies, this review study concluded that students' approaches to learning are significantly influenced by their perceptions of ICT-supported learning environment, academic ability, and prior educational experience. The results of this review study could serve as a basis for new studies to fill in the gaps in the corpus of knowledge regarding approaches to learning, particularly in the scope of accounting education and educational technologies. Future studies should be conducted to investigate several other factors which may influence students' approaches to learning in ICT-supported learning environment such as individual student's personality, socioeconomic background, and motivational factors.

References

- Abhayawansa, S., Tempone, I., & Pillay, S. (2012). Impact of entry mode on students' approaches to learning: A study of accounting students. *Accounting Education: An International Journal*, 21(4), 341–361.
- Abraham, A. (2006). Teaching and learning in accounting education: Students' Perceptions of the Linkages between teaching context, approaches to learning and outcomes. In Juchau, R. and Tibbits, G. (Eds.), *Celebrating accounting* (pp.9-21). New South Wales, Australia: University of Western Sydney.
- Arfah Salleh (2001). Integration of computers into accounting curriculum: A revisit. *Akauntan Nasional, Journal of the MIA*, 14(5): 42-47.
- Auyeung, P. K., & Sands, D. F. (1994). Predicting success in first-year university accounting using gender-based learning analysis. *Accounting Education*, 3(3), 259-272.
- Bahagian Pembangunan Kurikulum [Curriculum Development Section] (2009). *Sukatan Pelajaran Kurikulum Bersepadu Sekolah Menengah: Prinsip Perakaunan* [Syllabus for Integrated Secondary School Curriculum: Principles of Accounting]. Putrajaya: Bahagian Pembangunan Kurikulum, Kementerian Pelajaran Malaysia.
- Basu, P., & Cohen, J. (1994). Learning to learn in the accounting principles course: Outcome assessment of an integrative business analysis project. *Journal of Accounting Education*, 12(4), 359-374.
- Biggs, J. B. (1985). The role of meta-learning in study process. *British Journal of Educational Psychology*, 55, 185-212.
- Biggs, J. B. (1987). *Student approaches to learning and studying*. Hawthorn, Victoria: Australian Council for Educational Research.
- Biggs, J. B., & Moore, P. J. (1993). *The process of learning* (3rd ed.). New York: Prentice Hall.
- Biggs, J., Kember, D., & Leung, D. Y. P. (2001). The Revised Study Process Questionnaire. *British Journal of Educational Psychology*, 71, 133-149.
- Booth, P., Luckett, P., & Mladenovic, R. (1999). The quality of learning in accounting education: The impact of approaches to learning on academic performance. *Accounting Education: An International Journal*, 8, 277–300.

- Chan, Y. Y. G., & Watkins, D. (1994). Classroom environment and approaches to learning: An investigation of the actual and preferred perceptions of Hong Kong secondary school students. *Instructional Science*, 22, 233-246.
- Crawford, K., Gordon, S., Nicholas, J., & Prosser, M. (1998). Qualitatively different experiences of learning mathematics at university. *Learning and Instruction*, 8(5), 455-468.
- de Lange, P., Suwardy, T., & Mavondo, F. (2003). Integrating a virtual learning environment into an introductory accounting course: Determinants of student motivation. *Accounting Education: An International Journal*, 12(1), 1-14.
- Dochy, F., De Rijdt, C., & Dyck, W. (2002). Cognitive prerequisites and learning: How far did we progress since Bloom? Implications for educational practice and teaching, *Active Learning in Higher Education* 3 (3), 265-84.
- Duff, A., Boyle, E., Dunleavy, K., and Ferguson, J. (2004) The relationship between personality, approach to learning and academic performance. *Personality and Individual Differences*, 36, 8, 1907-1920.
- Eley, M. G. (1992). Differential adoption of study approaches within individual students. *Higher Education*, 23, 231-254.
- Gow, L., Kember, D. & Cooper, B. (1994). The teaching context and approaches to study of accountancy students. *Issues in Accounting Education*, 9(1), 118-130.
- Green, B. P., Reinstein, A., & Mc Williams, D. (2000). Using interactive courseware to teach the procedural components of introductory financial accounting. *Advances in Accounting Education: Teaching and Curriculum Innovations*, 3, 179-197.
- Hanuni Yusuf (2003). *Masalah pembelajaran dan pengajaran Prinsip Akaun* [Teaching and learning problems in Principles of Accounting]. Unpublished master's thesis. Universiti Kebangsaan Malaysia, Bangi, Selangor, Malaysia.
- Harmer, B. M. (2009). Teaching in a contextual vacuum: lack of prior workplace knowledge as a barrier to sensemaking in the learning and teaching of business courses. *Innovations in Education and Teaching International*, 46 (1), 41-50.
- Holschuh, J. P. (2000). Do as I say, not as I do: High, average, and low performing students' strategy use in biology. *Journal of College Reading and Learning*, 31, 94-107.
- Jackling, B. (2005). Perceptions of the learning context and learning approaches: Implications for quality learning outcomes in accounting. *Accounting Education*, 14(3), 271-291.
- Jebeile, S., & Abeysekera, I. (2010). The spread of ICT innovation in accounting education. *International Journal of Teaching and Learning in Higher Education*, 22(2), 158-168.
- Jones, A., Scanlon, E., Gaved, M., Blake, C., Collins, T., Clough, G. et al. (2013). Challenges in personalisation: Supporting mobile science inquiry learning across contexts. *Research and Practice in Technology Enhanced Learning*, 8(1), 21-42.
- Kember, D., Ng, S., Tse, H., Wong, E. T. T., & Pomfret, M. (1996). An examination of the interrelationships between workload, study time, learning approaches and academic outcomes. *Studies in Higher Education*, 21(3), 347-358.
- Kember, D., & Leung, D. Y. P. (1998). Influences upon students' perceptions of workload. *Educational Psychology: An International Journal of Experimental Educational Psychology*, 18(3), 293-307.
- Kember, D, Biggs, J. B., & Leung, D.Y.P. (2004). Examining the multidimensionality of approaches to learning through the development of a revised version of the Learning Process Questionnaire. *British Journal of Educational Psychology*, 74, 261-280.
- Kementerian Pelajaran Malaysia [Ministry of Education](2006). *Rancangan Malaysia Ke-9: Pelan Induk Pembangunan Pendidikan, 2006-2010* [Ninth Malaysia Plan: Blueprint of Education Development, 2006-2010]. Putrajaya: Kementerian Pelajaran Malaysia.
- Law, N., Lee, Y., & Chow, A. (2002). Practice characteristics that lead to 21st century learning outcomes. *Journal of Computer-Assisted Learning*, 18, 415-426.
- Lillie, R. E., & Wygal, D. E. (2011). Virtual Office Hours (VOH) in accounting coursework: Leveraging technology to enhance an integrative learning environment. *Journal of Accounting Education*, 29, 1-13.
- Lizzio, A., Wilson, K., & Simons, R. (2002). University students' perceptions of the learning environment and academic outcomes: Implications for theory and practice. *Studies in Higher Education*, 27(1), 27-52.
- Lord, B. R., & Robertson, J. (2006). Students' experiences of learning in a third-year management accounting class: Evidence from New Zealand. *Accounting Education*, 15(1), 41-59.
- Lucas, U. (2000). Worlds apart: Students' experiences of learning introductory accounting. *Critical Perspectives on Accounting*, 11, 479-504.
- Lucas, U. (2001). Deep and surface approaches to learning within introductory accounting: a phenomenographic study. *Accounting Education*, 10(2), 161-184.
- Maor, D. (2000). A teacher professional development program on using a constructivist multimedia learning environment. *Learning Environments Research*, 2, 307-330.

- Marriott, N. (2004). Using computerized business simulations and spreadsheet models in accounting education: A case study. *Accounting Education*, 13(S1), 55-70.
- Marton, F., & Säljö, R. (1976). On qualitative differences in learning: II. Outcome as a function of the learner's conception of the task. *British Journal of Educational Psychology*, 46, 115-127.
- McGowen, M. A. & Tall, D. O. (2010). Metaphor or Met-Before? The effects of previous experience on practice and theory of learning mathematics. *The Journal of Mathematical Behavior*, 29, 169-179.
- Meyer, J. H. F., Parsons, P., & Dunne, T. T. (1990). Individual study orchestrations and their association with learning outcome. *Higher Education*, 20(1), 67-89.
- Murphy, E. A., & Hoepfner, C. J. (2002). Using technology and library resources in financial accounting courses. *Journal of Accounting Education*, 20, 331-346.
- Neal, G. (2005). *Student reflections on the effectiveness of ICT as a learning resource*. Retrieved December 18, 2010, from <http://www.aare.edu.au/05pap/nea05582.pdf>
- Premuroso, R. F., Tong, L., & Beed, T. K. (2011). Does using clickers in the classroom matter to student performance and satisfaction when taking the introductory financial accounting course? *Issues in Accounting Education*, 26(4), 701-723.
- Ramsden, P. (1979). Student learning and perceptions of the academic environment. *Higher Education*, 8, 411-428.
- Ramsden, P. (2003). *Learning to Teach in Higher Education* (2nd ed.). London, U.K.: Routledge.
- Rashidah Hassan & Arfah Salleh (2008, July). *Issues and challenges in preparing teachers for ICT integration in classroom teaching and learning: The case of Principles of Accounting Sijil Pelajaran Malaysia – SPM (Malaysian Education Certificate – MCE)*. Paper presented at the Conference of Vocational and Technical Education and Training, Bali, Indonesia
- Richardson, J. T. E., Morgan, A. and Woodley, A. (1999) Approaches to studying in distance education, *Higher Education*, 37 (1), 23-55.
- Rohaila Yusof (2006). *Keberkesanan strategi pembelajaran pengalaman berasaskan Model Kolb terhadap pembangunan kompetensi pelajaran perakaunan di Institut Pengajian Tinggi Awam* [Effectiveness of Kolb Model-based experiential learning strategy on competency development of accounting students in Public Higher Education Institutions]. Unpublished master's thesis. Universiti Kebangsaan Malaysia, Bangi, Selangor, Malaysia.
- Rumpagaporn, M. W. (2007). *Students' critical thinking skills, attitude to ICT and perceptions of ICT classroom learning environments under the ICT schools pilot project in Thailand* (Doctoral dissertation, University of Adelaide, Australia). Retrieved from <http://digital.library.adelaide.edu.au/dspace/bitstream/2440/37896/1/02whole.pdf>
- Sharma, D. (1997). Accounting students' learning conceptions, approaches to learning, and the influence of the learning-teaching context on approaches to learning. *Accounting Education: An International Journal*, 6(2), 125-146.
- Siragusa, L. (2002). *Research into the effectiveness of online learning in higher education: Survey findings*. Retrieved May 6, 2010, from <http://www.waier.org.au/forums/2002/siragusa.html>
- Stanley, T., & Edwards, P. (2005). Interactive multimedia teaching of Accounting Information System (AIS) cycles: Student perceptions and views. *Journal of Accounting Education*, 23(1), 21-46.
- Suhaida Abdul Kadir (2002). *Perbandingan pembelajaran koperatif dan tradisional terhadap prestasi, atribusi pencapaian, konsep sendiri akademik dan hubungan sosial dalam pendidikan perakaunan* [Comparison between cooperative and traditional learning towards performance, performance attribution, academic self-concept, and social relationship in accounting education]. Unpublished doctoral dissertation, Universiti Putra Malaysia, Serdang, Selangor, Malaysia.
- Tan, B. S., & Wong, S. L. (2012). Fostering deep approach to learning for Principles of Accounting through ICT integration in Malaysian secondary schools. In G. Biswas et al. (Eds.), *Workshop Proceedings of the 20th International Conference on Computers in Education* (pp.112-118). Singapore: Asia-Pacific Society for Computers in Education.
- Tang, T. (2008). *A study of learning in Economics* (Doctoral dissertation, Queensland University of Technology, Australia). Retrieved from http://eprints.qut.edu.au/16691/1/Tommy_Tang_Thesis.pdf
- Tempone, I. (2001). *Variation in student learning in accounting* (Doctoral dissertation, Swinburne University of Technology, Melbourne, Australia). Retrieved from <http://researchbank.swinburne.edu.au/vital/access/manager/Repository/swin:7458>
- Watty, K., Jackson, M., & Yu, X. (2010). Students' approaches to assessment in accounting education: The unique student perspective. *Accounting Education: An International Journal*, 19(3), 219-234.
- Wells, P., de Lange, P., & Fieger, P. (2008). Integrating a virtual learning environment into a second-year accounting course: determinants of overall student perception. *Accounting and Finance*, 48, 503-518.

The Undergraduates' Attitude towards the Use of Asynchronous Online Discussion (AOD)

Noor Farah Shahida MOHD HARIS^{a*}, Rosnaini MAHMUD^a & Su Luan WONG^b

^a*Department of Foundation of Education, Universiti Putra Malaysia, Malaysia*

^b*Department of Science and Technical Education, Universiti Putra Malaysia, Malaysia*

*farahshahida@gmail.com

Abstract: This article intended to describe the undergraduates' attitude towards the use of asynchronous online discussion (AOD). A total of 269 undergraduates in Universiti Putra Malaysia (UPM) participated in this study. Attitudes scale consisted of 23 items with five point likert scale were used as the instrument in this study. Overall, findings of this study indicated that undergraduates have positive attitudes towards the use of AOD.

Keywords: Attitude, asynchronous online discussion (AOD), computer mediated communication (CMC)

1. Introduction

In the recent years use of Computer Mediated Communication (CMC) in higher education institutions (Ferriman, 2013; Sidhu & Embi, 2010) has increased due to the remarkable popularity of the Internet. Study shows that, students prefer to use asynchronous CMC as compare to synchronous CMC (Kocaman-Karoglu, Ozden, & Kiraz, 2011; Ali, & Joyes, 2007; Hewitt, 2005). The major shortcoming of synchronous CMC is that students are not able to partake at the same time due to the busy schedule and time restrictions (Huang & Hsiao, 2012).

Asynchronous online discussion (AOD) is described as “a text-based human-to-human communication via computer networks that provides a platform for the participants to interact with one another in exchanging ideas, insights and personal experiences” (Hew & Cheung, 2003, p. 249). The tools that supported AOD include fax, email, mailing list, calendar, survey and polls, internet bulletin, discussion boards, list-servers, newsgroups, forums, announcement, blackboard documents, wikis, blog and social networking sites [such as Facebook, Twitter, etc] (Ferriman, 2013; Huang & Hsiao, 2012; Chen, 2012; Ali, Ali, Abdullah & Ayub, 2008; Erlin, Yusof & Rahman, 2007; Roblyer, 2006; Rainsbury & Malcolm, 2003).

2. Literature Review

An individual' attitude plays an important role in directing and shaping individual's behaviour in daily live (Aydin, 2012; Schafer & Tait, 1986). An individual's attitudes can be influenced by mood and emotion (Ajzen & Fishbein, 2000). Ajzen and Fishbein (2000) have described attitude as favourable or unfavourable individual's degree of action with respect to a psychological object. The successful implementation of any educational technology utilization in teaching and learning process is also influenced strongly on students' positive attitudes towards the educational technology (Williams, Boyle, Molloy, Brightwell, Munro, Service, & Brown, 2011). Student's attitudes play as a crucial role in educational technology usage and are not subject to change unless it causes ineffectiveness (Onen, 2012). Therefore, it is valuable to have knowledge regarding students' attitudes towards the use of educational technology in directing better understanding pertaining students' communication behaviour in online learning (Aydin, 2012). Additionally, Williams *et al.* (2011) have stated that understanding students' attitudes towards educational technology would enable to facilitate the development and improvement of appropriate educational strategies and initiatives.

The theory that guided this study is Technology Acceptance Model (TAM) developed by Davis in 1986 (Davis, Bagozzi, & Warshaw, 1989). The TAM was formulated to predict computer usage

across a broad range of computer based technologies via five variables namely behavioural intention, attitude toward using, perceived usefulness, perceived ease of use, and external variables (Davis *et al.*, 1989). The TAM obtained various empirical supports for being one of a powerful and parsimonious in predicting technology acceptance and adoption (Wong, Osman, Choo & Rahman, 2013).

In this study, one of the elements in TAM that has been adopted is the attitudes variable. The attitude factor has been the spotlight of numerous studies in the use of educational technology (Abedalaziz, Jamaluddin, & Chin, 2013; Teo, 2012; Edmunds, Thrope & Conole, 2012; Aydin, 2012; Williams *et al.*, 2011). The previous studies have shown that students' positive attitudes towards educational technology determine the successful utilization of the educational technology (Abedalaziz *et al.*, 2013; Teo, 2012; Edmunds *et al.*, 2012; Aydin, 2012; Williams *et al.*, 2011). According to Teo (2012), students' attitude is the most dominant determinant of behavioural intention. He has recommended that, if the educational technology unable to fulfil students' need, they would decline to use it. Thus, it can be concluded that the undergraduates' use of AOD will be significantly influenced by their own attitude towards AOD.

3. Objective

The main purpose of this study was to determine undergraduates' attitude towards the used of asynchronous online discussion (AOD).

4. Research Methodology

4.1 Research Design

This study was based on quantitative research. According to Cohen, Manion and Morrison (2007) quantitative approach is a powerful research suitable for larger and smaller scale research, such as case studies, action research, correlational research and experiments. Thus, a descriptive research design was employed as it was believed to be the pertinent approach in order to determine the undergraduates' attitude towards the use of AOD.

4.2 Population and Sample

This study was carried out in the first semester 2012/2013 in Universiti Putra Malaysia (UPM) Serdang campus. Four faculties participated in this study and they were selected using a fishbowl random sampling technique where three faculties from the science stream (Faculty of Medicine and Health Sciences, Faculty of Science, and Faculty of Computer Science and Information Technology) and one faculty from the social science stream (Faculty of Human Ecology). These faculties represented the ratio of faculties in UPM where 12 sciences faculties and only four social sciences faculties (12:4). The total population for this study was 2770 undergraduates, where only the third semester undergraduates and above were selected as the target population. This was because they were assumed to be exposed to online learning for at least two semesters.

This study primarily applied the five-point Likert scale to measure continuous data and Cochran's formula was employed in order to identify the desired sample size (Bartlett, Kotlik & Higgins, 2001). As a result, the required sample size was 244. Oversampling technique was applied to overcome the sampling error (Cochran, 1997). As recommended by Cohen *et al.* (2007), this would able to increase up to 50% of sample size because the response rate is usually fewer than the target sample. Thus, the drawn sample size after oversampling was 366. A total of 370 questionnaires were printed and distributed among undergraduates, however only 313 were returned. About 44 questionnaires were excluded due to the missing values and extreme outlier. Hence, a total of 269 cases were valid to be analyzed.

4.3 Instrumentation

This study used attitude scale developed by Albirini (2006) which had acceptable validity and had been commonly used by others researcher all over the world. The researcher acquired Albirini's permission

to adapt, modify and translate the instrument. The attitude scale consisted of 23 items and used a five point Likert scale. The questionnaire was administered in English and Malay language as the undergraduates were found to use both languages as the medium of teaching and learning.

4.4 Validity and Reliability

The content validity was established to guarantee that each item used was accurate for the research and the subjects (Gay, Mills & Airasian, 2009). After the content validity process had been verified and established by three educational technology experts, the questionnaire was retained for the pilot test in assessment of the reliability among 40 undergraduates in UPM. All of the respondents were a third semester student and they were randomly selected and were not involved in the actual study. The tolerable Cronbach's alpha value of a scale instrument must above 0.70 (Pallant, 2001). The value of internal reliability obtained based on pilot study (N=40) was 0.86, while the internal reliability obtained based on the actual study (N=269) was 0.90. Therefore, this instrument had found to have an excellent internal consistency because all alpha level was greater than 0.70.

4.5 Data Analysis

SPSS 19.0 statistical package was used in order to analyze the data obtained from this study. Descriptive statistics (frequency, percentage, mean and standard deviation) were used for data interpretation.

5. Results

The undergraduates' attitude towards the use of AOD was measured using the Attitude Scale consisting 23 items of five point Likert scales. The descriptive analysis revealed that the mean score obtained for this attitude construct was 3.74 with standard deviation 0.49. Since, the mean score obtained was larger than the cut-off point of 3, the overall undergraduates' attitude towards the use of AOD considered as positive.

Based on the information presented in Table 1, most of the undergraduates stated that the AOD was an efficient means of getting information (M=4.09, SD=0.64). They were also agreed that the AOD was a means of getting information faster (M=4.07, SD=0.62). The majority of the undergraduates glad that the AOD was applicable in their lesson (M=3.97, SD=0.76). Moreover, most of the undergraduates stated that learning about the AOD is not a waste of time (M=3.91, SD=1.00). Additionally, the undergraduates reported that using the AOD could enhance their' learning (M=3.86, SD=0.70).

Furthermore, the majority of the undergraduates would like to learn more about the AOD (M=3.84, SD=0.66). The majority of undergraduates reported that using the AOD would be able to save more time (M=3.83, SD=0.74). The undergraduates also stated that using the AOD made them feel comfortable (M=3.82, SD=1.05). Most of the undergraduates reported that using the AOD was enjoyable (M=3.81, SD=0.71). In addition, most of the undergraduates stated that students must use the AOD in all courses (M=3.71, SD=0.95).

6. Discussion

In general, the undergraduates showed positive attitudes towards the use of AOD in learning process. This finding is congruence with some previous study conducted at higher education institutions which stated that students have an overall positive attitude towards using computer technology for instance the Internet and online communication (Abedalaziz *et al*, 2013; Aydin, 2012; Onen, 2012; Teo, 2012). According to Aydin (2012), students view asynchronous CMC as part and parcel in their social lives, as a technology are able to facilitate their lives because asynchronous CMC provides them with the opportunity to communicate anytime, anywhere and at their own convenience.

Table 1: Percentage of the undergraduates' attitude towards the use of AOD.

Items	Percentage (%)					M	SD
	1	2	3	4	5		
1. Using the AOD does not scare me at all.	1.9	7.4	19.3	49.8	21.6	3.82	0.92
2. Using the AOD makes me feel uncomfortable.*	2.6	11.2	16.4	41.3	28.6	3.82	1.05
3. I am glad that AOD is applicable in my lesson.	0.4	3.0	19.3	54.3	23.0	3.97	0.76
4. I do not like to interact with others using AOD. *	3.0	10.8	22.3	37.5	26.4	3.74	1.06
5. Using the AOD is enjoyable.	0.0	2.6	28.3	54.3	14.9	3.81	0.71
6. I dislike using the AOD in lessons.*	2.6	8.9	22.3	36.8	29.4	3.81	1.04
7. Using the AOD saves more times.	0.4	3.3	22.7	60.6	13.0	3.83	0.70
8. Using the AOD saves effort.	1.1	3.7	24.5	59.9	10.8	3.75	0.74
9. Universities would be a better place without AOD.*	2.2	12.3	19.3	34.9	31.2	3.81	1.08
10. Students must use the AOD in all courses.	1.9	5.6	36.1	33.1	23.4	3.71	0.95
11. Learning about AOD is a waste of time.*	0.7	10.4	19.3	36.4	33.1	3.91	1.00
12. AOD would motivate me to study more.	1.1	4.8	32.7	51.3	10.0	3.64	0.77
13. AOD is a means of getting information faster.	0.0	1.5	11.2	66.2	21.2	4.07	0.62
14. AOD is an efficient means of getting information	0.7	1.1	8.6	68.8	21.6	4.09	0.64
15. I do not think I would ever need the AOD in my classroom.*	2.2	14.9	24.5	45.0	13.4	3.52	0.98
16. AOD can enhance students' learning.	0.4	2.2	23.4	59.1	14.9	3.86	0.70
17. AOD does more harm than good.*	0.7	13.8	24.5	32.0	29.0	3.75	1.05
18. I would rather communicate face to face than using AOD.*	9.7	40.9	39.4	7.8	2.2	2.52	0.86
19. If I had enough time, I would use AOD.	0.0	4.5	26.4	56.5	12.6	3.77	0.72
20. I would avoid using AOD as much as possible.*	1.5	10.4	24.2	35.3	28.6	3.79	1.02
21. I would like to learn more about AOD.	0.0	1.5	26.0	59.1	13.4	3.84	0.66
22. I have no intention to use the AOD in the near future.*	1.1	12.6	22.7	32.7	30.9	3.80	1.05
23. I only use the AOD at my university when I am told to.*	4.8	16.7	37.5	28.3	12.6	3.27	1.04

*Items for which scoring is reversed.

1= Strongly Disagree; 2= Disagree; 3= Neutral; 4= Agree; 5=Strongly Agree

The findings also consistent with one of the 11 shifts of Malaysian educational system transformation which is leverage ICT to expand quality education across Malaysia (Ministry of Education Malaysia, 2013). The overall positive attitudes towards the use of AOD in learning process could be attributed to the availability and accessibility of computer and Internet technology provided by Universiti Putra Malaysia. Moreover, there were two possible rationales of high positive attitudes towards the use of AOD in learning process namely the high usage of computer and its applications in teaching instruction and student assignments (Abedalaziz *et al.*, 2013).

The results also revealed that majority of the undergraduates were comfortable, approximating and enjoy using the AOD in their lessons. Additionally, majority of the undergraduates also stated that they glad the AOD was applicable in their lessons. The findings were similar with prior studies (Alrushiedat & Olfman, 2013; Kocaman-Karoglu, Ozden, & Kiraz, 2011; Courtney & King, 2009) where all of them noted that majority of students like to use the AOD and thought the AOD was extremely useful.

Additionally, majority of the undergraduates reported that they would like to learn more about the AOD and recommended other students to use the AOD in all courses. In addition, majority of the undergraduates intended to use the AOD in the future and would not avoid in using the AOD in their lesson. There were few reasons that may underlie the obtained results. The undergraduates may felt that traditional class discussions were short and only limited to few students (Alrushiedat & Olfman, 2013; Bassett, 2011), while the AOD was more comprehensive, lively and gave them an equal chance to participate actively in class (Sidhu & Embi, 2010; Shana, 2009). Thus, they can explicitly express their

ideas and opinions in writing (Ng, Cheung & Hew, 2012; Bassett, 2011; Kocaman-Karoglu *et al.*, 2011; Sidhu & Embi, 2010; Cheung, Hew & Ng, 2008).

Furthermore, findings revealed that the undergraduates reported that using the AOD would be capable in saving more times and effort. The majority of the undergraduates agreed that AOD was an efficient means of getting information faster. Moreover, the undergraduates also stated that using the AOD would motivate them to engage more in learning and enhance their' learning achievement. The results imply that the undergraduates have realized the impact of the use of AOD in their learning process. These results were consistent with those of others studies and reported that the AOD facilitates students improve their learning skills (Kocaman-Karoglu *et al.*, 2011; Sidhu & Embi, 2010; Shana, 2009) and perform better in academic (Alrushiedat & Olfman, 2013; Kocaman-Karoglu *et al.*, 2011; Shana, 2009).

6. Conclusion

Overall, the undergraduates have positive attitudes in using AOD. On that noted, this study has provided a significant data in the body of knowledge particularly in online learning pedagogy at the higher education institutions in Malaysia. Results from this study may also help educational authorities and universities by suggesting issues that may influence undergraduates' attitudes towards the use of AOD in learning process. The findings of this research will also able to contribute to educational technology implementation by Universiti Putra Malaysia and facilitate in implementing successful frameworks of embedding online learning in higher educational institution system. The decision makers can take the necessary steps to encourage the positive attitudes in order to improve the use of AOD among undergraduates. The research data enable lecturers to use suitable type of AOD tools, strategies and technique in teaching and learning process.

Acknowledgements

The authors would like to acknowledge the Universiti Putra Malaysia's undergraduates from the participating faculties who took part in the study.

References

- Abedalaziz, N., Jamaluddin, S., & Chin, H. L., (2013). Measuring Attitudes toward Computer and Internet Usage Among Postgraduate Students In Malaysia. *Turkish Online Journal of Educational Technology*, 12(2), 200-216
- Ajzen, I., & Fishbein, M. (2000). Attitudes and the Attitude-Behavior Relation: Reasoned and Automatic Processes. In W. Stroebe & M. Hewstone (Eds.), *European Review of Social Psychology*: John Wiley & Sons.
- Albirini, A. (2006). Teachers' attitudes toward information and communication technologies: the case of Syrian EFL teachers. *Computers & Education*, 47, 373-398.
- Ali, S. H. S, Ali, W. Z. W., Abdullah, R., & Ayub, A. F. M. (2008). Exploring The Distance Learner's Readiness on The Use of Distance Technology. Paper presented at the 2nd International Malaysian Educational Technology Convention: Converging technology, pedagogy and content. MS Garden Hotel Kuantan, Pahang Darul Makmur, Malaysia.
- Ali, M. F., & Joyes, G. (2007). Measuring Online Interaction. 1st International Malaysian Educational Technology Convention 2007: Smart Teaching & Learning: Re-engineering ID, Utalization and Innovation of Technology, Johor Bahru, Malaysia, Malaysian Educational Technology Association (META).
- Alrushiedat, N., & Olfman, L. (2013). Aiding Participation and Engagement in a Blended Learning Environment. *Journal of Information Systems Education*, 24(2), 133-145.
- Aydin, I. (2012). Attitudes toward Online Communications in Open And Distance Learning. *Turkish Online Journal of Distance Education (TOJDE)*, 13(4), 333-346.
- Bartlett, J. E., Kotrlik, J. W., & Higgins, C. C. (2001). Organizational Research: Determining Appropriate Sample Size in Survey Research. *Information Technology, Learning and Performance Journal*. 19(1), 43-50.
- Bassett, P. (2011). How Do Students View Asynchronous Online Discussions As A Learning Experience?. *Interdisciplinary Journal of E-Learning & Learning Objects*, 769-79.
- Chen, L. (2012). Improving Teachers' Teaching with Communication Technology. *Journal of Educational Technology Systems*, 40(1), 35-43.

- Chen, C., Pedersen, S., & Murphy, K. (2012). The influence of perceived information overload on student participation and knowledge construction in computer-mediated communication. *Instructional Science*, 40(2), 325-349. Doi:10.1007/s11251-011-9179-0
- Cheung, W. S., Hew, K. F., & Ng, C. S. L. (2008). Toward an understanding of why students contribute in asynchronous online discussions. *Journal Educational Computing Research*. 38(1), 29-50.
- Cochran, W. G. (1977). *Sampling Techniques* (3rd ed.). New York: John Wiley and Sons.
- Cohen, L., Manion, L., & Morrison, K. (2007). *Research Methods in Education* (Sixth ed.). New York: Routledge Taylor & Francis Group.
- Courtney, A. M., & King, F. B. (2009). Online dialog: A tool to support preservice teacher candidates' understanding of literacy teaching and practice. *Contemporary Issues in Technology and Teacher Education* (Online serial), 9(3), 226-256.
- Davis, F. D., Bagozzi, R. P., & Warshaw, P. R. (1989). User acceptance of computer technology: A comparison of two theoretical models. *Management Science*, 35(8), 982-1003.
- Edmunds, R., Thorpe, M., & Conole, G. (2012). Student attitudes towards and use of ICT in course study, work and social activity: A technology acceptance model approach. *British Journal of Educational Technology*, 43(1), 71-84. doi:10.1111/j.1467-8535.2010.01142.x
- Erlin, Yusof, N., & Rahman, A. A. (2007). *Computational Models of Learner's Interaction in Collaborative Learning: Preliminary Study*. 1st International Malaysian Educational Technology Convention 2007: Smart Teaching & Learning: Re-engineering ID, Utilization and Innovation of Technology, Johor Bahru, Malaysia, Malaysian Educational Technology Association (META).
- Ferriman, N. (2013). The impact of blended e-learning on undergraduate academic essay writing in English (L2). *Computer & Education*, 60, 243-253.
- Gay, L. R., Mills, G. E., & Airasian, P. W. (2009). *Educational research: Competencies for analysis and application* (9th ed.). New Jersey: Merrill, Pearson Education, Inc.
- Hew, K. F. & Cheung, W.S. (2003). An exploratory study of the use of asynchronous online discussion in hypermedia design. *Journal of Instructional Science & Technology*, 6(1).
- Hewitt, J. (2005). Toward an Understanding of How Threads Die in Asynchronous Computer Conferences. *The Journal of the Learning Sciences*. 14(4), 567-589.
- Huang, X. S., & Hsiao, E.-L. (2012). Synchronous and asynchronous communication in an online environment: Faculty experiences and perceptions. *The Quarterly Review of Distance Education*. 13(1), 15-30.
- Kocaman-Karoglu, A., Ozden, M., & Kiraz, E. (2011). Using Asynchronous Communication Tools to Support Face-to-Face Courses: Turkish Preservice Teachers' Perspectives. *International Journal of Applied Educational Studies*, 10(2), 59-73.
- Ministry of Education Malaysia. (2013). *Malaysia Education Blueprint 2013-2025 (Preschool to Post-Secondary Education)*. Retrieved 19 October 2013 from <http://www.moe.gov.my/en/pelan-pembangunan-pendidikan-malaysia-2013-2025>
- Ng, C. L., Cheung, W. S., & Hew, K. F. (2012). Interaction in asynchronous discussion forums: peer facilitation techniques. *Journal of Computer Assisted Learning*, 28(3), 280-294. doi:10.1111/j.1365-2729.2011.00454.x
- Onen, A. (2012). Effects of Educational Beliefs on Attitudes towards Using Computer Technologies. *Hacettepe University Journal of Education*, (43), 353-361.
- Pallant, J. (2001). *SPSS Survival Manual*. Australia: Allen & Unwin.
- Rainsbury, E. and P. Malcolm (2003). Extending the classroom boundaries - an evaluation of an asynchronous discussion board. *Accounting Education*. 12(1), 46-61.
- Roblyer, M. D. (2006). *Integrating educational technology into teaching* (4th Ed.). Upper Saddle River, New Jersey Columbus, Ohio: Pearson Merrill Prentice Hall.
- Shana, Z. (2009). Learning with Technology: Using Discussion Forums to Augment a Traditional-Style Class. *Educational Technology & Society*. 12(3), 214-228.
- Schafer, R. B., & Tait, J. L. (1986). A guide for understanding attitudes and attitude change. North Central Regional Extension Publication 138, 1-11.
- Sidhu, R. K., & Embi, M. A. (2010). Learner E-tivities: Exploring Malaysian Learners' Roles in Asynchronous Computer-Mediated Communication. *European Journal of Educational Studies*, 2(2), 157-174.
- Teo, T. (2012). Examining the intention to use technology among pre-service teachers: an integration of the Technology Acceptance Model and Theory of Planned Behavior. *Interactive Learning Environments*, 20(1), 3-18. doi:10.1080/10494821003714632
- Williams, B., Boyle, M., Molloy, A., Brightwell, R., Munro, G., Service, M., & Brown, T. (2011). Undergraduate paramedic students' attitudes to e-learning: findings from five university programs. *Research in Learning Technology*, 19(1), 89-100. doi:10.1080/21567069.2011.586679
- Wong, K. T, Osman, R., Choo, G., & Rahman, M. K. (2013). Understanding Student Teachers' Behavioural Intention to Use Technology: Technology Acceptance Model (TAM) Validation and Testing. *International Journal of Instruction*, 6(1), 89-104.

University Teachers' Needs of Support for Designing and Preparation of Courses: A Focus on Differences by Academic Discipline and Rank

Fumiko KONNO^{a*} & Takashi MITSUISHI^b

^a*Institute for Excellence in Higher Education, Tohoku University, Japan*

^b*Center for Information Technology in Education, Tohoku University, Japan*

*fumiko@m.tohoku.ac.jp

Abstract: In order to clarify the specific support needs of university teachers for the design and preparation of courses, and to incorporate these fundamental data into developing effective and practical programs or ICT tools for Professional Development, this paper analyses differences according to the academic ranks and disciplines of survey respondents. The authors conducted a university-wide survey in 2012 targeting faculty members at Tohoku University. Results show that the need for orientation sessions, seminars, and counseling is higher among teachers in their early career phases, such as for Lecturers and Assistant Professors. On the other hand, teachers regardless of their academic rank or discipline have certain needs such as “Digitization of teaching materials” and “Classroom observations of other teachers’ lessons (by video)”. Although the percentage is not high, the need for “Reflection or reviewing of own teaching” is considered common across all academic ranks and disciplines. In contrast, a need for “Classroom observations of other teachers’ lesson (by video)” is less needed by Professors. It is expected that Professors might already have enough experience in teaching and prefer learning from their own practice rather than from others in seminars or teaching observations. These differences are considered to have a relation to a teacher’s approach to course design. It is necessary to consider these differences and commonalities among teachers when we develop practical support systems or programs for university teachers.

Keywords: professional development, faculty development, teacher needs, teacher support

1. Introduction

Under pressure from policy makers and society, universities are engaged in coordinated efforts for improving the quality of teaching, which is better known as Professional Development (or Faculty Development). Usually, a Professional Development program is offered by a centralized teaching and learning center, or by individual departments in universities. However, it has been indicated that priorities among coordinators of such development programs focus more on meeting individual faculty needs rather than responding to the critical needs of the institution (Sorcinelli *et al.*, 2006). Solving this problem, Gillespie *et al.* (2010) noted the importance of incorporating institutional research and data on teaching and learning. In order to develop and offer effective and practical programs or ICT tools for Professional Development, it is important to know how university teachers design their courses as well as their actual needs for support on teaching improvement.

To obtain fundamental data about the above points, the authors conducted a university-wide survey in 2012 targeting faculty members at Tohoku University, Japan. In the previous preliminary report (Konno *et al.* 2013), the overall trend and situation of teachers’ approaches were reported. Also, the report indicated that the teachers’ approaches and support needs might vary between academic disciplines.

Several studies have indicated that there are differences between disciplines which impact on research activities (for example, Sparks, 2005). Despite the acknowledged importance of teaching, and the large body of research on teaching, the role of disciplines in shaping teaching is a relatively new focus (Neumann, 2001). The issue of whether, and how, teaching varies across the various disciplines has received limited attention (Hativa *et al.*, 1995, Neumann 2001). Smeby (1996) conducted a survey

which targeted Norwegian universities and clarified that there are significant field differences in the time spent on teaching and preparation and in the distribution of time between different types of teaching and learning levels.

In order to clarify the details of university teachers' support needs in designing and preparing courses, and to incorporate this fundamental data into the program development process, this paper analyzed the data from the Tohoku University survey from the perspective of the respondents' academic rank (academic appointment) and discipline.

2. Method

2.1 Survey Administration

The authors conducted a university-wide anonymous survey in March 2012. A questionnaire was distributed via inter-university mail to all full-time teachers at Tohoku University, excluding sessional or part-time teachers. Twenty-four questions regarding course design were asked.

2.2 Survey Analysis

In this paper, we focus on answers to one question from the survey: “*What kind of support would you like to use for your course design and class preparation?*”

When answering the above question, we asked the teachers to choose and answer about one course which they taught during the 2011 academic year at Tohoku University. Multiple answers were allowed. The answers were analyzed using chi-square (χ^2) tests, in terms of differences among different academic rank and discipline.

3. Findings

3.1 Survey Respondents.

The survey response rate was 47.4% (N=1290). 153 teachers out of 1290 declined to answer the survey because they had never taught in the University. Therefore a valid response rate for this survey was 41.8% (N=1137) (Center for the Advancement of Higher Education, Tohoku University, 2014).

Table 1 provides the academic rank of the respondents. According to the official records of Tohoku University as of May 1st 2011, the proportions of faculty academic ranks were: Professor (30.1%), Associate Professor (25.0%), Lecturer (5.4%), and Assistant Professor (39.5%) (Tohoku University, 2011). Hence, the proportion of the respondents' academic rank of this survey has approximate correspondence to the actual proportions of Tohoku University's personnel.

Table 1: Respondents' academic ranks.

Academic Rank	Number	%
Professor	369	32.5
Associate Professor	310	27.3
Lecturer	85	7.5
Assistant Professor	362	31.8
Other	11	1.0
Total	1137	100.0

Table 2: Respondents' academic disciplines.

Disciplines	Number	%
Humanities	65	5.7%
Social Sciences	77	6.8%
Agriculture	61	5.4%
Sciences	333	29.3%
Engineering	215	18.9%
MDP	372	32.7%
Other/No response	14	1.2%
Total	1137	100.00

Table 3: Respondents' academic ranks and disciplines.

	Professor		Associate Professor		Lecturer		Assistant Professor		Total	
Humanities	26	7.1%	24	7.9%	5	6.0%	10	2.8%	65	5.8%
Social Sciences	36	9.8%	28	9.2%	2	2.4%	10	2.8%	77	6.8%
Agriculture	21	5.7%	18	5.9%	0	0.0%	21	5.8%	61	5.4%
Sciences	67	18.3%	66	21.8%	9	10.8%	68	18.9%	215	18.9%
Engineering	126	34.3%	106	35.0%	7	8.4%	94	26.1%	333	29.9%
MDP	91	24.8%	61	20.1%	60	72.3%	157	43.6%	371	33.2%
Total	367	100.0%	303	100.0%	83	100.0%	360	100.0%	1122	100.0%

Table 2 provides the academic disciplines of the respondents. An approximate estimate of the proportion of each discipline in Tohoku University based on the published numbers of each faculty (eliminating inter-disciplinary fields and institutions) for 2011 was: Humanities (6.4%), Social Sciences (10.4%), Agriculture (7.8%), Sciences (18.2%), Engineering (24.3%), and Medicine, Dentistry and Pharmacology (24.3%) (Tohoku University, 2011). In this survey, we have more respondents from Sciences and Medicine, Dentistry and Pharmacology (MDP) compared to actual proportions of faculty members in Tohoku University.

Table 3 shows a breakdown of respondents' disciplines according to their academic rank. 72.3% of Lecturer respondents were from MDP. It is necessary to note this ratio when we look into the results of the analysis by respondents' academic ranks.

3.2 Overall Trend of the Support Needs for University Teachers

Figure 1 shows responses to the question: "What kind of support would you like to use for your course design and lesson preparation?"

Although 23% of teachers answered that they need nothing in particular, more than 20% of teachers responded that they would like to access supports such as "11. Classroom observations of other teachers' lesson (by video)" (25.4%); "4. Digitization of teaching materials" (24.8%); and "1. Orientation session by university or department about teaching" (23.6%) (Konno *et al.* 2013).

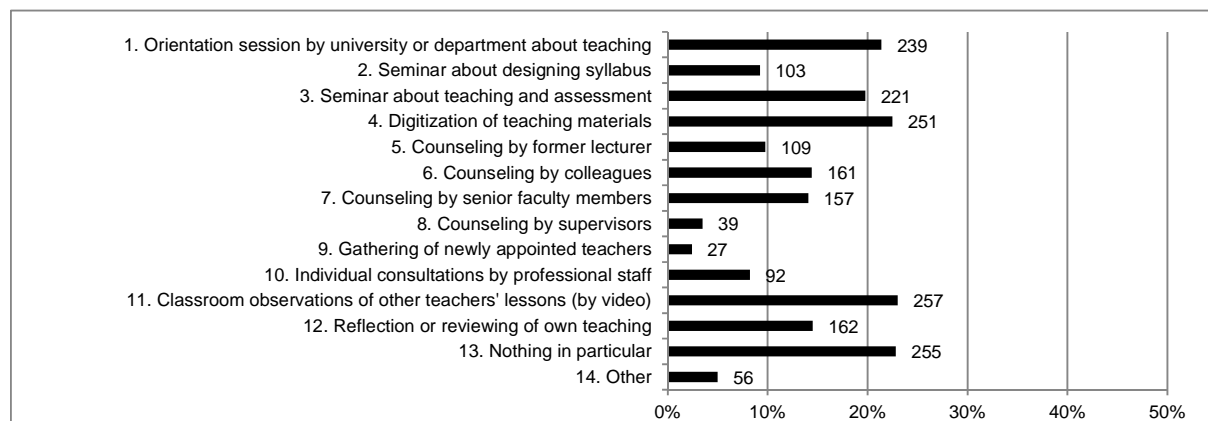

Figure 1. What kind of support would you like to use for your course design or lesson preparation? (All respondents, N=1117) (Konno *et al.* 2013).

3.3 Differences between Academic Ranks

Figure 2 provides the results as organized by the teachers' academic ranks.

More Professors (31.7%) answered that they needed "13. Nothing in particular" for any support, compared to 15.4% of Lecturers ($\chi^2(3)=15.348$, significant at $p<.01$). On the other hand, more Professors (7.8%) selected "14. Other" and described concrete ideas of support as other options

($\chi^2(3)=14.648, p<.05$). “1. Orientation session by university or department about teaching” is more needed by early career teachers ($\chi^2(3)=19.681, p<.001$). “2. Seminar about designing syllabus” is higher among Lecturers (26.9%), while less needed among Professors (3.9%) ($\chi^2(3)=44.069, p<.001$). Also, the need for “3. Seminar about teaching and assessment” is higher among Lecturers (34.6%) ($\chi^2(3)=15.877, p<.01$).

The needs for counseling, such as “5. Counseling by former lecturer” ($\chi^2(3)=67.703, p<.001$), “7. Counseling by senior faculty members” ($\chi^2(3)=42.743, p<.001$), and “8. Counseling by supervisors” ($\chi^2(3)=25.929, p<.001$), as well as a need for “9. Gathering of newly appointed teachers” ($\chi^2(3)=16.947, p<.01$) are more needed by early career academics. Regarding the need for “6. Counseling by colleagues”, however, there was no significant difference between teachers’ academic ranks ($\chi^2(3)=5.595$).

A need for “10. Individual consultations by professional staff” is higher among Lecturers ($\chi^2(3)=9.973, p<.05$); while “11. Classroom observations of other teachers’ lesson (by video)” is more needed by early career academics ($\chi^2(3)=10.451, p<.05$). Although there were significant differences between academic rank regarding needs of support on 11 options out of 14, the needs for “4. Digitization of teaching materials ($\chi^2(3)=2.368$ ”, “6. Counseling by colleagues ($\chi^2(3)=5.595$)” and “12. Reflection or reviewing of own teaching ($\chi^2(3)=2.890$)” had no significant differences. Especially, “4. Digitization of teaching materials” had a relatively high need among teachers: Professor (26.9%), Associate Professor (23.6%), Lecturer (19.2%), and Assistant Professor (24.4%). In other words, support for digitization of teaching materials is needed regardless of teachers’ academic ranks.

3.4 Differences between Academic Disciplines

Figure 3 provides the results as organized by disciplines.

The need for “2. Seminar about designing syllabus” is higher in Medicine, Dentistry and Pharmacology. (16.1%) ($\chi^2(5)=26.014, p<.001$), and low in Sciences (4.1%). “5. Counseling by former lecturer” is more needed by Sciences (14.5%) and Engineering (12.8%), compared to Humanities (3.4%) and Social Sciences (4.1%) ($\chi^2(5)=11.766, p<.05$). Also a need for “6. Counseling by colleagues” is higher in Engineering (19.7%) and Humanities (23.7%), and low in Agriculture (5.3%) and Medicine, Dentistry and Pharmacology (10.2%) ($\chi^2(5)=20.070, p<.01$). A need for “8. Counseling by supervisors” is higher in Medicine, Dentistry and Pharmacology (7.4%) ($\chi^2(5)=18.865, p<.01$). “11. Classroom observation of other teachers’ lesson (by video)” is more needed in Medicine, Dentistry and Pharmacology (30.7%), Humanities (32.2%), and Agriculture (31.6%), compared to Sciences (19.7%) ($\chi^2(5)=14.164, p<.05$).

There were no significant differences by disciplines on a need for “1. Orientation session by university or department about teaching” ($\chi^2(5)=10.661$), “3. Seminar about teaching and assessment” ($\chi^2(5)=0.464$), “4. Digitization of teaching materials” ($\chi^2(5)=2.072$), “7. Counseling by senior faculty members” ($\chi^2(5)=6.657$), “9. Gathering of newly appointed teachers” ($\chi^2(5)=7.689$), “10. Individual consultations by professional staff” ($\chi^2(5)=6.589$), and “12. Reflection or reviewing of own teaching ($\chi^2(5)=7.702$).

4. Discussion

The results show the differences and commonalities of support needs according to academic rank and disciplines. Relatively popular support needs were: “11. Classroom observations of other teachers’ lesson (by video)” (25.4%); “4. Digitization of teaching materials” (24.8%); “1. Orientation session by university or department about teaching” (23.6%); and “3. Seminar about teaching and assessment” (21.8%).

First of all, overall trends of support needs show that early career faculty express more needs compared to Professors. However, a need for “6. Counseling by colleagues” (in total: 15.9%, Professor: 12.3%) has no significant difference in academic ranks. Thus, opportunities for sharing their own issues and situation about teaching with colleagues have a common demand regardless of academic rank. From the point of view of academic disciplines, counseling by colleagues is more needed in Engineering, Agriculture, and Humanities.

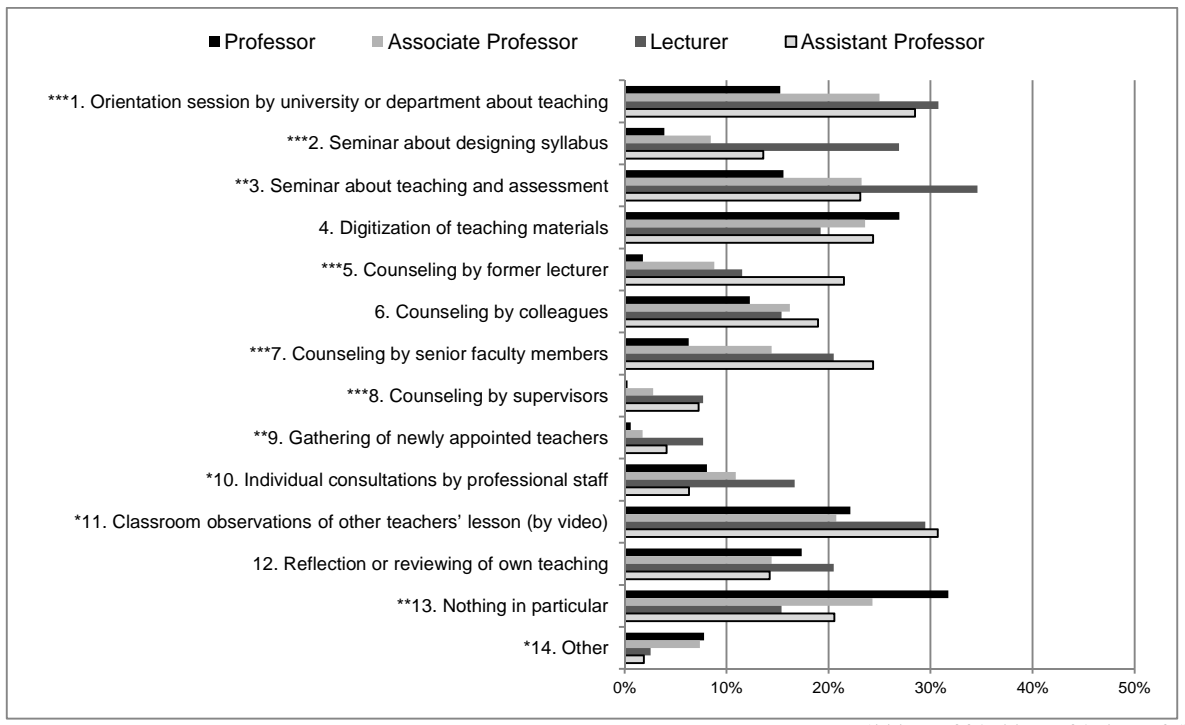

(***: $p < .001$, **: $p < .01$, *: $p < .05$)

Figure 2. Teachers' support needs by academic rank.

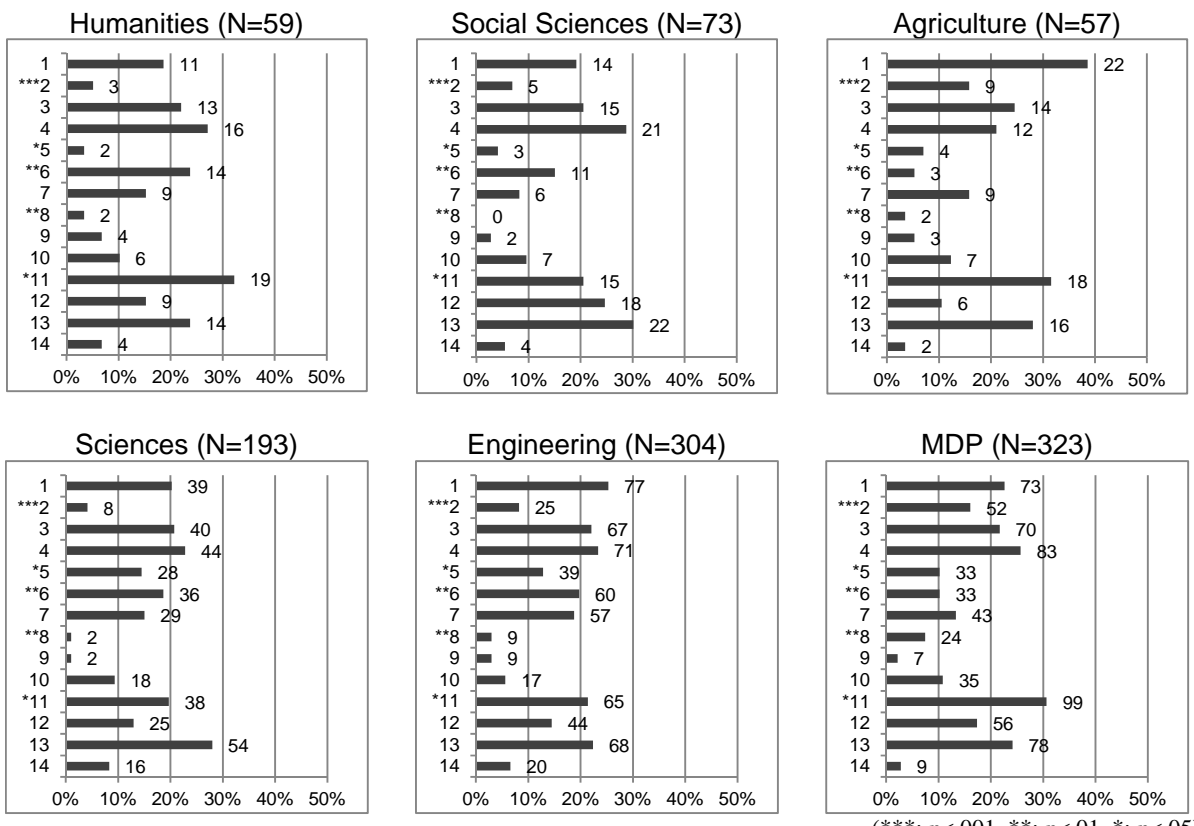

(***: $p < .001$, **: $p < .01$, *: $p < .05$)

Figure 3. Teachers' support needs by academic disciplines.

A need for "Reflection or reviewing of own teaching" showed no significant difference in academic ranks (in total: 16.0%, Professor: 17.4%) or disciplines. Although the percentage is not high, it is considered that the need for "Reflection or reviewing of own teaching" commonly exists regardless of academic ranks and disciplines. On the other hand, a need for "Classroom observations of other

teachers' lesson (by video)" is less needed by Professors. It is expected that Professors might recognize they already have enough experience in teaching; and therefore prefer learning from their own practice rather than from others in seminars or teaching observations.

A need for "Digitization of teaching materials" also has no significant difference among academic ranks (in total: 24.8%, Professor: 26.9%) or disciplines. This means that "Digitization of teaching materials" is commonly needed by teachers, regardless of academic rank or discipline. As for the specific content of the digitization of teaching materials, the following are expected: creating PowerPoint slides, creating audio-visual materials, or changing analog materials into computer friendly materials, etc. To clarify the details of teachers' demands, an additional survey or interview is needed.

5. Conclusion

In order to clarify the details of university teachers' needs of support for designing and preparation of courses, and to incorporate this fundamental data into developing effective and practical programs or ICT tools for Professional Development, this paper analyzed differences by academic disciplines and rank of respondents. From the results of the analysis, we found that the support needs of university teachers for designing courses are different according to academic rank and discipline.

Especially, there are certain needs of "Digitization of teaching materials" and "Classroom observations of other teachers' lessons (by video)" regardless of teachers' academic rank or disciplines. It would be useful to consider the differences and commonalities when developing support systems or training programs for those teachers.

As a future work, we need to undertake a more detailed analysis of the results including other scopes of statistical data analysis, such as the respondents' age groups and the types of courses teachers answered about. In addition, in order to clarify the reason and background for the differences in their support needs, we are planning to undertake an interview process.

Acknowledgements

We wish to express our gratitude to faculty members of Tohoku University who contributed to the survey and to the Center for Professional Development for sponsoring it. We also wish to thank Prof. Takashi Hata, Dr. Machi Sato, Dr. Shinji Tateishi and CPD staff members for all of their support for this survey. This work was also supported by JSPS KAKENHI 24700883 and 23501092.

References

- Center for the Advancement of Higher Education, Tohoku University. (eds) (2014). *Report of a survey on university teachers' course preparation. CAHE TOHOKU Report 53*. Japan. (in Japanese).
<http://www3.he.tohoku.ac.jp/cahe/wp-content/uploads/2011/06/7311a5cfb0e7162a6cb01c9429643010.pdf>
- Gillespie, K. J., Robertson, D.L., & Bergquist W. H. (2010) *A Guide to Faculty Development*, 2nd Edition, Jossey-Bass: San Francisco.
- Hativa, N. & Matincovich, M. (eds) (1995). *Disciplinary Difference in Teaching and Learning: Implications for Practice*. Jossey-Bass: San Francisco.
- Konno, F. & Mitsuishi, T. (2013). How university teachers design their courses. *Proc. IEEE E10-HTC2013*, 292-297. <http://ieeexplore.ieee.org/stamp/stamp.jsp?arnumber=06669058>
- Neumann, R. (2001). Disciplinary Differences and University Teaching. *Studies in Higher Education*, 26(2), 135-146.
- Smeby, J. (1996). Disciplinary Differences in University Teaching. *Studies in Higher Education*. 21(1), 69-79.
- Sorcinielli, M. D., Austin, A. E., Eddy, P. L., & Beach, A. L. (2006). *Creating the future of faculty development : Learning from the past, understanding the present*. Bolton, MA: Anker.
- Sparks, S. (2005). JISC Disciplinary Differences Report. *JISC Report*.
<http://www.jisc.ac.uk/media/documents/themes/infoenvironment/disciplinarydifferencesneeds.pdf>
- Tohoku University (2011). *Tohoku University Fact Book 2011*.
<http://www.tohoku.ac.jp/japanese/disclosure/media/01/media0102/>

Using a PBL Authoring Tool to Train Teachers in Designing an Online PBL Unit

Yongwu MIAO^{a*}, Mohammed SAMAKA^b, Disi WANG^a,
Zeyad ALI^b & Michael H. ROMANOWSKI^c

^a*Department of Computational and Cognitive Sciences, University of Duisburg-Essen, Germany*

^b*Computer Science and Engineering Department, Qatar University, Doha, Qatar*

^c*College of Education, Qatar University, Doha, Qatar*

*miao@collide.info

Abstract: Problem-based learning (PBL) is proposed as one of the most well-known alternatives to subject-based learning in educating graduates to become independent workers, critical thinkers, problem solvers, lifelong learners, and team workers. However, the PBL practice is still far from widespread. One of serious impediments to PBL's diffusion in education is that teachers have difficulties in transforming a subject-based course into a problem-driven course. In addition, teachers lack the necessary skills to make informed judgments and decisions about how to use technologies in their PBL practices. The purpose of this research is to support teachers in developing an online PBL unit. Based on schema theory we developed a PBL scripting language and an associated PBL authoring tool. The tool was developed for teachers to represent, communicate, and reuse their PBL course/lesson plans implementing in technology-enhanced learning environments. It is assumed that it can also be used as a means to educate teachers who may be not familiar with PBL to learn PBL design and to develop an online PBL unit. Through conducting an experiment we found that the PBL authoring tool can facilitate teachers to make informed decisions in their design practice through following a formal design method. Most participants of the experiment thought that the tool is useful to design an online PBL unit and easy to learn.

Keywords: Teacher training, Problem-based learning (PBL), Learning Design, Schema theory, PBL scripting language, online PBL unit

1. Introduction

A growing urgency to prepare students for 21st century challenges has many educators looking for new instructional approaches. Problem-based learning (PBL) is proposed as one of the most well-known alternatives to subject-based learning. In PBL, through learning to collect information, analyze data, develop hypotheses and apply strong deductive reasoning to the problem at hand, students acquire a deep understanding of knowledge and lifelong learning skills (Hmelo & Eberbach, 2012). However, the PBL practice is still far from widespread. One of serious impediments to PBL's diffusion in education is that teachers, with few exceptions, do not have the expertise to transform a lecture-driven course into a problem-driven course because they are well-versed in teaching and lecturing, but have a difficult time changing their role to that of a facilitator who guides students but does not give the answers (Ertmer & Simons, 2006). In addition, many information and communication technologies (ICT) tools have been used to support the implementation of PBL such as accessing learning resources and fostering collaboration (Kaldoudi, et. al. 2008). Teachers normally lack the necessary expertise to make informed judgments and decisions about how to incorporate contemporary tools and resources to maximize learning in context. They may lack experiences to design and conduct a PBL course integrating digital tools and resources to promote student learning and creativity.

The shift to PBL creates an important question for teachers: How do I design a PBL course to meet goals for both content mastery and 21st century learning? The research work described in this paper is to educate teachers in the development of technology-enhanced PBL courses through adopting the approach of learning by design (Koehler & Mishra, 2005). We adopt this approach to engage teachers in meaningful design problems in an attempt to facilitate their adoption of PBL practices and to improve their use of technology. However, learning to design an online PBL unit is a difficult and

time-consuming task. To facilitate teachers in the design of an online PBL unit, we developed a PBL authoring tool. Our assumption is that teachers using the PBL authoring tool can easily acquire relevant knowledge about how to develop an online PBL unit as they are guided to make informed decisions.

2. Learning Design and PBL Scripting Language

Learning design has emerged as a distinct field of research, which is concerned with the development of methods, tools, and resources for helping designers in their design process (Koper, 2001; Beetham & Sharpe, 2007; Lockyer et. al., 2008). It focuses on planning, structuring and sequencing learning activities and designing learning context and environment with technical support for knowledge construction from the perspectives of learners. It also denotes the result or product of the design process, a computational description of a teaching-learning process that may happen in a lesson or a course. Learning design aims at providing a means to represent and communicate the designs of learning activities so that they can be shared among practitioners at design-time. Furthermore, the learning designs can serve as a means to orchestrate and scaffold teaching and learning practice at run-time (Koper & Tattersall, 2005; Miao et. al., 2005).

Analogous to the music notation that contains enough information to convey musical ideas from one person to another over time and space, researchers in the field of learning design tried to develop a notational system for describing and sharing learning design ideas. Many learning design languages and associated tools have been developed in the past decade such as IMS-LD (IMS-LD homepage), LAMS (Dalziel 2000), and CompendiumLD (Conole et. al. 2008). These learning design languages were developed for describing a wide range of pedagogical strategies. However, the practitioner has difficulties representing complex learning activities using languages like IMS-LD (Miao & Koper, 2007), because the vocabularies of these languages are pedagogy-irrelevant and technology-oriented terms such as “activity”, “property”, “learning object”, and “data-type”. They provide less or even no vocabularies and guidance to represent and implement specific pedagogic strategies such as problem-based learning. In order to support the design and sharing of PBL practices, we developed a PBL scripting language. The framework that we used to define the PBL scripting language is theoretically based on schema theory (Schank 1977). According to schema theory, generalized knowledge about a list of the characteristic events involved in a common routine is called a script (Schank, 1977). Scripts can be used to organize procedural knowledge, to assist recall, to guide behavior, to predict likely happenings, and to help individuals make sense of our current experiences. People know how to behave and what to expect in particular situations by using scripts. Scripts are mental structures representing the person’s knowledge about objects, people, or situations. As shown in Figure 1, the process of eating at a restaurant can be described as a script that is divided into five ‘scenes’. When a scene finishes, another scene may start. In this restaurant script, there are three roles: consumer, waiter, and chef. The script embodies knowledge about how people in a particular role (e.g. waiter, or customer) are expected to behave in each scene. For example, it is expected that a chef prepares the food that the customer ordered and a waiter passes the food to the customer in the serving scene. After being served, the customer should eat the food in the eating scene. Such expected behaviors are called behavior rules. A behavior rule combines a role, an action, an object, and others such as tool and resource. In order to represent procedural knowledge in restraint, we can define vocabularies and relevant rules that can be used to specify various restaurant scripts such as those used in McDonalds or a buffet style restaurant.



Figure 1. A typical restraint script

In the light of schema theory, we developed a PBL scripting language through analyzing and summarizing well-known PBL models. Using the language, we can represent a PBL unit as a PBL script – a computational description of a PBL process. A PBL script has properties such as *title*, *learning objectives*, *prerequisites*, *description*, *driving problem*, *target learners*, and *estimated duration*. It consists of a set of phases that can be executed in sequence (as the default structure), in parallel, in branch or in loop. When designing a phase, a teacher should choose one or more phase types from the

following list: *preparation, problem engagement, problem definition, idea generation, learning issue identification, plan, information sharing, investigation, reasoning, problem resolution, evaluation, application, reflection, and report*. In addition, associated phase types such as *facilitation, collaboration, basic cognition, and assessment* will be associated with any given phase. In a given phase, only certain types of activities are suggested for completion. For example, in the phase *problem engagement* the following four types of activities are suggested: *present case/situation/scenario, observe phenomenon, introduce problem trigger, and clarify concept*. A type of activity may produce a certain type of artifact. The artifact types of this phase are *case, scenario, situation, phenomenon, and observation*. Another example is a phase with a type of *learning issue identification*. It can contain the following activity types: *identify learning issue, formulate learning issue, organize learning issue, and identify knowledge need*. The artifact types of this phase type are *learning issue* and *learning need*. After the teacher defines a phase through choosing one or multiple phase types, the user can further specify the activity structure within the phase in details.

Each phase consists of one or several activities that may be performed in sequence (as the default structure as well), in parallel, in branch, or in loop. Various process structures can be specified using arrows. When designing an activity, one can only choose an activity type from the types specified by the chosen phase types. One can specify an activity by assigning values to the activity properties such as *title, learning objectives, description, work mode, starting condition, and completion condition*. A choice of a certain property such as *time limit* as a choice of the completion condition will need further specification. In this case, one needs to specify how many hours to perform this activity. In addition, the constraints between the type of artifact and the type of activity are specified as well. For example, in the phase with a chosen type *problem engagement*, an activity *present a case* can be arranged. A learning resource with a type *case* can be used as an input of the activity. In a phase with a type of *learning issue identification*, one can arrange an activity by choosing an activity type *formulate learning issue* and define an artifact with a type of *learning issue* as an output. It also enables a detail design of an activity by defining the relations with *actors, learning resources, and tools*. For example, the teacher can assign the actor of activity with a type of *formulate learning issue* as a learner, a facilitator, a group of learners, all groups in a class, or all learners in a class. If the actor of an activity is assigned to multiple people, it is needed to further specify whether they should perform the activity individually, separately, or collaboratively. If choosing collaboratively, one has to further choose communicative or/and collaborative tools such as chat-room and whiteboard.

3. Using a PBL Authoring Tool to Design an Online PBL Unit

Planning an online PBL unit can be daunting, especially for the novice. It includes many tasks such as choosing standards and learning objectives, defining a driving problem, preparing resources, grouping students, arranging learning environments, structuring and sequencing learning activities, choosing assessment rubrics and criteria, and exploiting technologies. In order to facilitate the design of an online PBL unit, we developed a web-based graphical PBL authoring tool, called PLATE Workbench. Rather than using pedagogy-irrelevant constructs provided by IMS-LD authoring tools such as Re-Course (Griffithsa, et al. 2009) and Prolix OpenGLM (Neumann and Oberhuemer, 2009), one can use the vocabularies and rules specified by the PBL scripting language. The tool provides guidance and restrictions for the teacher to develop an online PBL unit as a PBL script. The user of the tool, for example, a teacher will be guided to make informed decisions. The user interface of the tool consists of five parts. The menu bar on the top lists basic function and the state bar on the bottom indicates the current edit state. The central area contains the file manager (on the left), the graphic edit space (in the middle), and the property edit panel (on the right). Figure 2 provides a screenshot of the tool to edit a PBL script in the activity-level. The tool enables the teacher to define activities by dragging and dropping an activity node. The type of the activity can be defined by choosing one from a list of activity types that are specified in the selected phase types. The activity can be further defined by assigning values of attributes and by connecting with actor nodes, resource nodes, tool nodes, and artifact nodes. The specified relations between concepts (e.g., which type of activity can produce which type of artifact using which type of tool) within the PBL scripting language will be used as constraints to guide and restrict the construction of the diagram. Detail description of the tool and the technical implementation of the tool can be seen in (Wang, et. al. 2014).

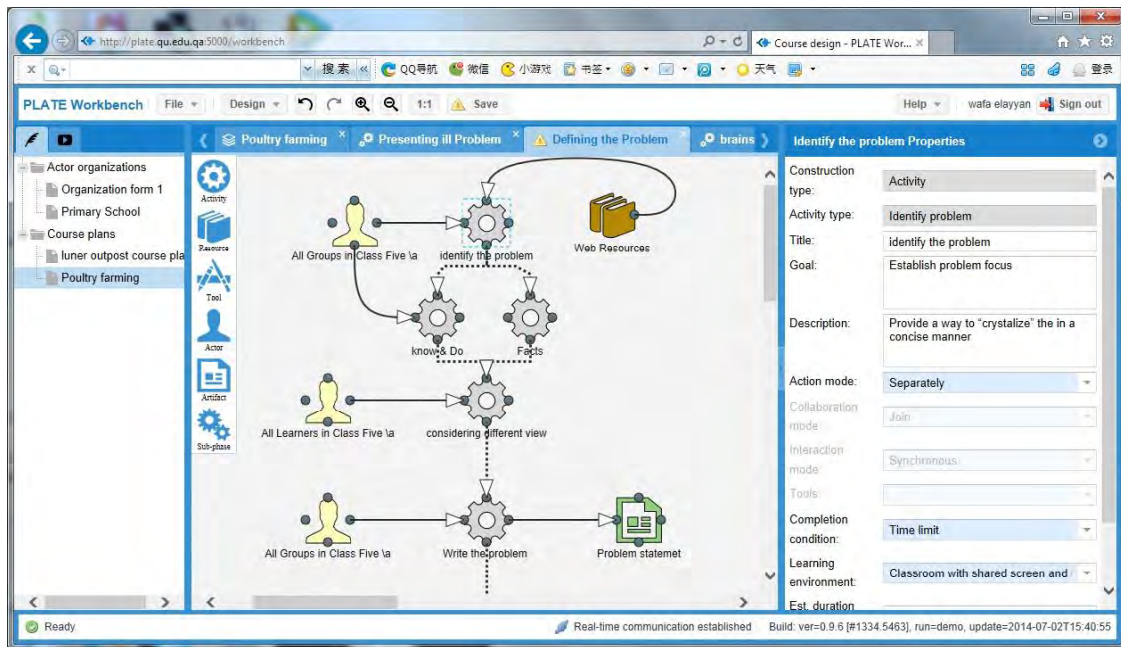

Figure 2. User Interface of the PLATE Workbench

4. A Pilot Study

In order to investigate whether the PBL authoring tool can be used to train teachers in designing an online PBL unit, we conducted a pilot study. We adopted an approach of learning by design to educate novice to acquire PBL knowledge and become familiar with the procedure and informed decisions. Here, we use the approach “learning by design” defined by Koehler and Mishra (2008) because their focus, like ours, is on teacher learning and professional development.

The pilot study was conducted in the College of Education at Qatar University. Participants in the pilot study were students from Masters in Education program and were enrolled in the end of the program internship having already completed an advanced curriculum development and design course. Most of the participants are still working as teachers in primary, preparatory and secondary schools or working in the education-relevant fields. This pilot study was arranged as a part of the course. In the course, two sessions were arranged and each session took three hours. In the first session, participants were introduced to PBL including basic PBL concepts, principles, and benefits. They were instructed how to design an online PBL module, in particular, to choose ill-structured problems, to design various process structures and to arrange individual and collaborative activities with various communicative and collaborative tools. At the end of the first session participants were briefly introduced PBL scripting language and the PBL authoring tool. Participants were required to create a user account in the PBL Workbench and to learn the tool by using a user manual and a tutorial video on their own. In the first half of the second session, participants were guided to represent a pre-designed PBL module with the PBL authoring tool step by step. In the second half of the session, participants applied what they learned through continually working on the representation of the pre-defined PBL module. During this time, some participants asked questions that were answered immediately in the class. Then the participants had to complete an assignment within ten days to create a PBL script with the tool. The assignment is centered on their authentic design problems. All participants (N = 17) completed their PBL scripts on time. Finally, participants were required to response to a questionnaire. Seventeen responses were collected and all were valid responses.

Two types of data were collected. The first type was collected from participants’ responses to the questionnaire. The questionnaire consisted of five sections: section I asked questions about participants’ background; section II addressed the computer literacy of the participants; section III contained Likert-scale questions (selecting one of five responses ranging from 1: strongly disagree to 5: strongly agree) designed for collecting participants’ attitude to the PBL authoring tool; and section IV included open questions designed for collecting participants’ feedback. The questions are mainly relevant to the ease to use and learn. According to participants’ responses to the questions in section I, it

was evident that all participants are university students and most of them are also teachers in subject areas including Arabic, math, English, health, and science. The data showed that most participants had minimal prior knowledge of PBL and that the levels of computer literacy of most participants are around an average level. The second type of data is the PBL scripts created by the participants using the PBL authoring tool and stored in the database persistently. The collected PBL scripts were assessed using three scoring rubrics: completeness, contextualization, and reasonableness. Each rubric score was ranged from 1 to 10 and the grade of a PBL script is the mean of three rubric scores. Two experts rated the students' PBL scripts and each final score is means of scores given by the two experts.

We analyzed the relations between the scores of the students and their prior PBL knowledge and their computer literacy. It seems that the influence of computer literacy on the final score is not significant. However, prior PBL knowledge has a slight positive influence on the final score. In addition, the means of the scores of all fifteen items in section III are larger than 3.0 and the total mean of the scores is 3.6. Obviously, most participants thought that it is easy to learn to make informed decisions and the tool is easy to use to design an online PBL unit. It seems that when students think the tool is easy to use, the higher score the student received.

It is obvious that participants will definitely acquire more knowledge about how to design an online PBL unit if they learn how to use the tool and it is impossible for them to represent an online PBL unit without the tool. We directly asked open-ended questions in section III to collect students' feedback. In relation to the usefulness of the tool in design of an online PBL unit, students wrote: *"I used the PBL Workbench for a science lesson. It was suitable for the topic."* *"When I used the PBL Workbench I did not have any difficulties performing a task. There were various possibilities to work with."* *"I liked the way. It allows connections to be made between various elements, actors, activities, etc. I also liked that it provides clarity to every phase and activity as it asks for goals and other details."* *"This tool was amazing in helping me develop the plan of how to conduct performance management at the school especially with the complications of connections to be made."* *"It was new and exciting experience for me".*

In response to the question about whether it is easy to learn, students stated: *"I would not say easy. It took me time to understand the thing I needed to represent my design and not sure if it's the right thing. Yet I think with more understanding and practice it could become easy in time and the use of different design form."* *"First I thought it was difficult. When I started to work with it, I found it is not that difficult, yet not an easy one to use."* *"It will be easy if there are PBL model templates to help teacher to design one because it took me a long time to design a course plan."*

When answering the questions regarding the vocabularies and rules provided by the PBL scripting language, the participants reported that the vocabularies and rules were very helpful. They stated: *"I think that a pre-defined list of choices facilitate the design. It saves time and efforts."* *"Of course, it facilitates the work, especially for the teacher with little experience, while for expertise teachers it might limit the options, or ideas."* *"I did not understand these terms until developing the course plan."* *"I think they are ok and there are a lot of options to choose from which represent the basic items that are used in phase or activity. Yet I think if we could have the possibility to add our own ones ..."* *"From my point of view it enhances and facilitates process. It gives us an option to explore and think critically. I found it appropriate, and enough to help in PBL. On the other side, yes more options will be good addition, as 'more sugar, more sweet'."*

In terms of aspects of the tool that were most valued, students wrote: *"It provides students with greater flexibility in developing solution strategies."* *"It is flexible as we are able to define as many phases as we wish and as many activities as we wish within each phase I used in my design three phases and more than 2 activity in each and it was easy."* *"PBL Workbench is very flexible and helpful, easy to use, and has many multiple options that represent various forms."* *"The workbench is flexible as it does not restrict us to any particular PBL model and gives room to design a PBL with as many phases we require depending upon the project."* It seems that the flexibility is an important feature of the tool.

Nevertheless, the data also revealed that students need more instruction and assistance. Some students noted that: *"Lots and lots of options and information which I need more training on."* *"I did develop my lesson using all of these things, it is not difficult, yet I think if there is a way to explain them more or demonstrate the different way they can be represented."* *"... it could be easier if there were ready-made PBL example models the teacher can choose and change what is needed for the lessons. For example, it became similar to Microsoft publisher that have ready-made template to use and change."*

5. Conclusions

Feedback received from the participants indicated that most agreed that the PBL authoring tool is easy to learn and use for designing an online PBL unit. The tool provides guidance to make informed decisions and provides options for choosing. Participants especially emphasized that vocabularies and rules specified in the PBL scripting language make it easy to understand and design a PBL script and that the tool provides flexibility. The responses to the questions about students' perception of the tool are basically positive and most PBL scripts created by the students were quite good.

Based on the feedback from the participants, it is important to instruct potential users on the theory of PBL and explain what are informed decisions and possible choices. Also, it is important to provide more examples and help on how to use the PBL authoring tool and to provide support to users as they develop an online PBL unit. The feedback from participants in this pilot study indicates that the PBL authoring tool will be useful for teachers to develop an online PBL unit.

Acknowledgement. This paper was made possible by NPRP grant # NPRP 5 - 051 - 1 – 015 from the Qatar National Research Fund (a member of Qatar Foundation). The statements made herein are solely the responsibility of the authors.

References

- Beetham, H. and Sharpe, R. (Eds) (2007). *Rethinking pedagogy for a digital age*, Routledge Falmer: London.
- Conole, G., Brasher, A., Cross, S., Weller, M., Clark, P. and White, J. (2008). Visualising learning design to foster and support good practice and creativity, *Educational Media International*, 54(3), pp. 177-194.
- Dalziel, J. (2003). Implementing learning design: The Learning Activity Management system (LAMS). *Proc. Ascilite Conference*, pp. 593–596, Figtree: Ascilite.
- Ertmer, P. A. and K. D. Simons, K. D. (2006) Jumping the PBL Implementation Hurdle: Supporting the Efforts of K–12 Teachers, *The Interdisciplinary Journal of Problem-based Learning*, volume 1, no. 1, 40-54.
- Griffithsa, D., Beauvoira, P., Libera, O. & Barrett-Baxendaleb M. (2009). From Reload to Re-Course: learning from IMS Learning Design implementations. *Distance Education*, 30(2), pp. 201-222.
- Hmelo-Silver, C.E. and Eberbach, C. (2012). Learning theories and problem-based learning. In: Bridges, S., et. al. (eds.), *Researching problem-based learning in clinical education: The next generation*. pp. 3-17. New York: Springer.
- IMS Learning Design Specification, <http://www.imsglobal.org>, 2003
- Kaldoudi, E., P. Bamidis, M. Papaioakeim, and V. Vargemezis, (2008). Problem-Based Learning via Web 2.0 Technologies, *Proc. the 21st IEEE International Symposium on Computer-Based Medical Systems*, pp. 391-396.
- Koehler, M., & Mishra, P. (2008). Introducing TPACK. *Handbook of Technological Pedagogical Content Knowledge (TPCK) for Educators* (pp. 3-29). New York, NY: Routledge.
- Koper, E.J.R.. (2001). Modeling Units of Study from a Pedagogical Perspective: the Pedagogical Meta-model behind EML. *Open University of the Netherlands*.
- Koper, R. & Tattersall, C. (Eds.) (2005). *Learning design: A handbook on modelling and delivering networked education and training*. Berlin: Springer.
- Lockyer, L., Bennett, S., Agostinho, S., & Harper, B. (2008). *Handbook of Research on Learning Design and Learning Objects: Issues, Applications and Technologies*. Hershey, PA: Information Science Reference.
- Miao, Y., Hoeksema, K., Hoppe, U., and Harrer, A. (2005). CSCL Scripts: Modeling Features and Potential Use. *In: Proceedings of CSCL2005*, pp. 423-432, Taipei, Taiwan.
- Miao, Y. & Koper, R. (2007). An Efficient and Flexible Technical Approach to Develop and Deliver Online Peer Assessment. *In: Proceedings of CSCL2007*, p. 502-511, July 16-21, 2007, New Jersey, USA.
- Neumann, S. and Oberhuemer, P. (2009). User Evaluation of a Graphical Modeling Tool for IMS Learning Design. *In: Proc. International Conference of Web-based Learning 2009*, pp. 287-296. August 19-21, 2009. Aachen, Germany: LNCS 5686, Springer.
- Schank, R. C., and Abelson, R. P. (1977). *Scripts, plans, goals, and understanding*. Hillsdale, NJ: Erlbaum.
- Wang, D., Miao, Y., Hoppe, U. & Samaka, M. (2014) A Flexible System and Data Model for the Representation and Management of PBL Scripts. *In: Proceedings of the 22nd International Conference on Computers in Education (In Press)*, Nov. 30 – Dec. 4, 2014, Nara, Japan.

Using the ePortfolio System to Foster Student Self-regulated Learning

Lap Trung NGUYEN^{a*}, Mitsuru IKEDA^b

^a*Faculty of Science and Technology, Hoa Sen University, Vietnam*

^b*School of Knowledge Science, Japan Advanced Institute of Science and Technology, Japan*

*lap.nguyentrung@hoasen.edu.vn

Abstract: This research explores the effects of using ePortfolio systems on student self-regulated learning. An ePortfolio system was developed based on self-regulated learning models and the relations among ePortfolio, competency, and self-regulated learning models. Then, the ePortfolio system was used for designing a learning model for self-regulated learning. The first experiments of the model were conducted in software engineering courses at the Hoa Sen University, Vietnam. The surveys with the Motivated Strategies for Learning Questionnaire (MSLQ) were conducted at the beginning and at the end of the courses. The differences in MSLQ scales between pre- and post-tests, and between control and experimental groups were evaluated. In addition, the trace data of learning was also analyzed in order to evaluate the effects of the learning model on student self-regulated learning. The results show that students could implement and link self-regulated learning processes in the ePortfolio system. In addition, the scores of MSLQ scales improved after applying the ePortfolio-based learning model in the courses. In conclusion, the ePortfolio system and the proposed learning model had positive effects on students' self-regulated learning skills.

Keywords: Self-regulated learning, ePortfolio system, competency measuring

1. Introduction

Self-regulated learning (SRL) is defined as a process by which learners self-regulated their learning. SRL has positive effects on learners' achievement in and beyond school (Winne, 2005; Zimmerman, 2002). SRL skills relate to the core competencies for the 21st century (Wolters, 2010). Self-regulated learners are aware of what knowledge and skills they have and proactive in learning; they view learning as a controllable process and accept more responsibility for the results of this process (Zimmerman, 1990). Thus, fostering SRL helps students improve academic achievement and to prepare for workplace learning.

Winne (2005, 2010) claimed that learners need significant support to make SRL productive. In addition, SRL skills are teachable (Zimmerman, 2002) and may be fostered by technology enhanced learning environments (Bartolomé and Steffens, 2011; Zimmerman and Tsikalas, 2005; Devolder, Braak, and Tondeur, 2012), for example, ePortfolio platform.

In order to self-regulate learning, the learners have to know their knowledge and skills and observe learning processes. Thus, learners need support in competency assessment and performance. Research shows that ePortfolio environments provide us a potential approach to competency assessment (Gadbury-Amyot, et al., 2003; Rao, et al., 2012). Indeed, ePortfolios store learners' achievements and the processes of reaching the achievements (JISC, 2008). In other words, ePortfolios contain and show students' competencies and the evidence of the competencies. Thus, ePortfolios can improve the reliability and accuracy of competency assessment. In addition, instructors and learners also need environments that can support users in modeling and sharing SRL principles and implementing SRL processes.

In this research, we propose, implement, and evaluate an ePortfolio-based learning model for scaffolding student self-regulated learning in university. An ePortfolio system was developed based on SRL models and background knowledge about fostering SRL. This paper focuses on the evaluation of the use of the ePortfolio system for enhancing SRL in university.

In the next section, we summarize the research background and related work. Next, we introduce the use of the ePortfolio system for learning and study design. Then, the results of the study are represented. In the last section, we make conclusions about the effects of the system, limitations and future work.

2. Research background

2.1 Self-regulated learning (SRL)

From the process perspective, self-regulation is a self-directive process in which students convert their mental abilities to academic skills. Learning is a proactive process in which students actively participate with major responsibility and motivation (Zimmerman, 2002). Zimmerman (1998) expressed the structure and function of self-regulatory processes in terms of three cyclical phases: forethought, performance, and self-reflection. In addition, an integrated model was introduced in (Pintrich, 2004), which consists of four phases of SRL: task definition and planning, monitoring, control, and reaction and reflection; and four areas for regulation: cognition, motivation, behavior, and context.

Self-regulated learners have some skills, such as setting goals, planning strategies, monitoring performance, changing the context, managing time, evaluating methods, attributing causation results, and adapting future methods (Zimmerman, 2002). They tend to have high motivation and confidence for learning and use productive problem solving skills. These characteristics lead to relevant behavior and also a high level of achievement (Perry and Winne, 2013).

2.2 Fostering self-regulated learning

Self-regulated learning may be taught and fostered (Winne, 2005; Bartolomé and Steffens, 2011). According to Zimmerman (1998), SRL emerges from two essential sources: social and self-directed experiences. The “self” in SRL implies that learners regulate learning, however, self-regulation does not mean solo (Perry and Winne, 2013). Learners’ development of SRL depends on support from the others, for example, teachers or peers.

Scaffolding SRL includes interactions between humans and the use of technological tools, resources, and environments. SRL skills may be fostered by technology enhanced learning environments (Bartolomé and Steffens, 2011; Devolder, Braak, and Tondeur, 2012; Steffens, 2001). Zimmerman and Tsikalas (2005) argued that a key to developing self-regulated learners is linking the processes of the forethought, performance, and self-reflect phases. Thus, computer-based learning environments that support self-regulatory processes in the all three phases are more likely to support SRL better.

Bartolomé and Steffens (2011) argued that ePortfolios have a potential to foster SRL. ePortfolios allow learners to think critically and become active, independent and self-regulated learners (Abrami, et al., 2008). In addition, ePortfolio environments are tools for gathering data about events that constitute self-regulation, which are needed for fostering SRL (Winne, 2005; Zimmerman, 2008).

2.3 ePortfolios and self-regulated learning

An ePortfolio is defined as the product, created by the learner, a collection of digital artifacts articulating experiences, achievements and learning (JISC, 2008). The literature shows that ePortfolios, competency, and self-regulated learning are related to each other. For example, competency measuring affects self-regulated learning (Voorhees, 2001; Zimmerman, 2002, 2008), ePortfolios improve competency measuring (Gadbury-Amyot et al., 2003; Rao et al., 2012), and ePortfolios provide a relevant environment for practicing self-regulated learning skills (Abrami et al., 2008; Hadwin et al., 2010; Perry and Winne, 2013; Ryan and Ryan, 2012). Thus, ePortfolios improve competency measuring, demonstrating that both ePortfolios and competency measuring can foster self-regulated learning.

Competencies are the learning outcomes or the prerequisites of learning activities (Voorhees, 2001). In SRL, learners are required to self-evaluate their competencies and performances in order to

regulate their learning (Zimmerman, 2002). In addition, competency assessment allows learners to set goals, judge efficacy, and plan time and effort based on their conditions; it enhances awareness of cognition, motivation, behavior, and context; finally, it is used for self-reflection.

ePortfolios store achievements and the processes of reaching these achievements (Rao, et al., 2012). They are used to document competencies and examine how students reflected on their competency development process (Zawacki-Richter and Hanft, 2011). ePortfolios contain evidence of competencies, which includes artifacts and processes. ePortfolios help learners and external evaluators to better understand competency, and improve their ability to evaluate it.

ePortfolio systems are relevant environments for reflection and collaboration (Ryan & Ryan, 2012). Thus, an ePortfolio system is used as a platform for practicing SRL processes, which is a key to fostering SRL (Hadwin, Oshige, Gress, and Winne, 2010; Perry and Winne, 2013). With the ability to trace learning processes, ePortfolio systems allow learners to monitor learning, reflect on their learning, and make changes in learning strategies to reach the goals. Learners also can show their results to the others and cooperate with others in ePortfolio systems. These functions can promote the intrinsic motivation of learners (Vockell, 2008), which is an important factor of SRL (Pintrich, 2004; Zimmerman, 2002).

There are some issues concerning ePortfolios for self-regulated learning. Currently, no ePortfolio models for self-regulated learning are available. The literature also does not explore the relations among ePortfolios, competency, and self-regulated learning explicitly. In addition, there is a lack of reports about the impacts of such ePortfolio models on self-regulated learning. More knowledge about if or how ePortfolio systems affect student self-regulated learning is needed.

3. ePortfolio-based learning model for fostering self-regulated learning

3.1 Using the ePortfolio system for learning

Based on the above analyses and self-regulated learning models, an ePortfolio system was developed. The focus was on improving ePortfolios' capacity for measuring competencies, capturing and sharing self-regulated learning principles, and practicing self-regulated learning processes. The system helps instructors to design programs, create program plans, observe learning activities, evaluate learning outcomes, give feedback, and hold discussions with students. Students can use the system to create learning plans, manage artifacts, monitor learning processes, evaluate task progresses and learning outcomes, and reflect on feedback and results. The system is as a platform for interactions between students and instructor and among students

The ePortfolio system is used to design learning. ePortfolio-based learning is integrated into courses, and is used as a supplement that supports formal class activities in order to foster students' self-regulated learning skills. An evaluation form for an activity is used by students and instructors. This form appears after evaluators select a student and an activity in the plan. The first part of this form contains information about the time period, time passed, and progress of the activity. The second part lists all artifacts that are the outputs of the current activity. The goal competencies of the activity are shown in the next part, in which evaluators can check the evidence and update the levels of competencies. The last part contains the discussions that are related to the activity type of the selected activity.

3.2 Study design

The first experiments were conducted at the Hoa Sen University, Vietnam. The ePortfolio system was used in two courses: Data Structure and Algorithms (DSA), and Software Development Processes and Tools (SDPT). The DSA class had 48 first-year students, who were split into two groups (for computer lab room section), randomly one group was selected, and in the selected group voluntary students were called to use the ePortfolio system for learning. In the SDPT class, all 18 fourth year students were recommended to use the ePortfolio system for this course. The students used the ePortfolio system for learning for eight weeks.

To measure self-regulated learning, a self-reporting method with the Motivated Strategies for Learning Questionnaire (MSLQ) (Pintrich et al., 1991) was used. MSLQ allows us to measure different

motivational components and the use of learning strategies in a given course. The MSLQ consists of 6 motivational and 9 learning strategies subscales. The 6 motivation subscales measure intrinsic goal orientation, extrinsic goal orientation, task value, control of learning beliefs, self-efficacy, and test anxiety. The 9 learning strategy sub scales measure rehearsal, elaboration, organization, critical thinking, metacognitive self-regulation, effort regulation, peer learning, and help seeking. The MSLQ consists of 81 questions, which the students rated using a Likert scale from “1 not at all true of me” to “7 very true of me.”

MSLQ surveys were conducted in DSA and SDPT classes in the first and the last weeks of the semester. All students were told before the survey that their participation was voluntary and not related in any way to their grades in the course. With self-report scores, to examine how the ePortfolio system affected students’ learning, the mean differences between groups were evaluated by using 2-tailed t-test with p-values of <0.05 were considered significant (Cheang, 2009).

A trace method was used for measuring and exploring students’ self-regulated learning skills by using the ePortfolio system. In previous studies (Hadwin et al., 2007; Perry and Winne, 2006; Zimmerman, 2008), the authors argued the benefits of using trace methodology to examine the dynamic perspective of self-regulated learning. The log file was analysed to examine the frequency and sequence of learning activities. Time-based analysis was used to evaluate the changes in learning over time.

3.3 Results

With the SDPT class 18 responses were collected for both the pre- and post-tests. In the DSA class, 27 responses for the pre-test and 39 responses for the post-test were received. After the post test, based on the logged data, a control group with 25 students and an experimental group with 14 students were determined. The students who did not use the ePortfolio system comprised the control group. In the control group, 13 students responded to both pre- and post-tests, while experimental group had 10 students who responded to both tests. All “reversed” items in MSLQ were reversed before scores were computed.

In the study with the SDPT course, all 18 students used the ePortfolio system. In order to evaluate the effects of the ePortfolio system on motivation and learning strategy subscales, a paired 2-tailed t-test was used to examine the differences between pre-test and post-test. The effects of the ePortfolio system on students’ motivation and use of learning strategies are now summarized. Data described in this and the remaining parts of the results section can be obtained from the authors. Positive effects were reported in thirteen scales. The data shows that the use of the ePortfolio system might contribute to significant improvement in some scales, such as metacognitive self-regulation ($p=0.001$), critical thinking ($p=0.002$), elaboration ($p=0.004$), and rehearsal ($p=0.028$). These scales relate directly to self-regulated learning (Pintrich, 2004); hence it is reasonable to argue that the system implemented had positive effects on students’ self-regulated learning skills. Although not statistically significant, improvement was seen in task value ($p=0.057$), and intrinsic goal orientation ($p=0.069$). Two scales show negative effects, but neither are significant (help seeking, $p=0.452$; Time/study environment management, $p=0.872$). Overall, MSLQ scores indicate that the system affected students’ learning in a positive manner. Therefore, the ePortfolio system promoted students’ motivation, and learning strategies.

In the study with the DSA course, the means of scales of post-tests in two groups were compared by using unpaired 2-tailed t-test. The results show that the experimental group is dominant in all scales (control mean $<$ experimental mean, except test anxiety scale, but it means that there is less worry in the experimental group). The experimental group’s scores are significantly higher on some scales that relate to self-regulated learning, such as intrinsic goal orientation ($p<0.001$), effort regulation ($p=0.002$), self-efficacy for learning and performance ($p=0.012$), elaboration ($p=0.023$), metacognitive self-regulation ($p=0.032$), and task value ($p=0.036$). In addition, the differences in control of learning beliefs ($p=0.066$), organization ($p=0.07$), and rehearsal ($p=0.095$) were considered also. This comparison supports the results of the previous study in the SDPT class.

Trace data was stored in XML files, each element containing information about a performed activity, such as participants, time, which activity, and which course. A log analyzer was developed to generate frequency counts, and transition statistics. From this information, transition matrices and

transition graphs were created. In this report, only the trace data of the SDPT course was examined because all students in this class used the ePortfolio system.

Results show that students performed 50/81 of possible transition types. 'Create plan' is the first activity; after that, students can update plan, create artifact, or review feedback. 'Review feedback' and 'evaluate activity' are not only the most frequent activities, but also the most central activities. 'Review feedback' connects to the other seven activities and can be the end points of transitions that begin with the other activities. 'Evaluate activity' links to the other six activities in both directions. This finding indicates that by using the system, 'review feedback' and 'evaluate activity' become the central tactics of learning strategies. Students usually review feedback (for example, observe discussions, evaluations, progress, and personal plan) and evaluate task progress before and after doing other activities. This pattern of learning aligns with reflection-based learning, and supports self-regulated learning.

A transition graph is formed by nodes and directional lines; each node is represented by a type of activity with its respective percentage. In general, the more active learners, the more nodes and transitions in the transition graph. A graph can demonstrate the general trend of the classes' use of learning strategies in a particular period. Thus, by comparing the graphs the changes in learning trends over time can be examined. The transition graph shows that the students learned quite actively because all nodes were connected to others with 50 patterns of transition. In addition, the activities and transitions in the graph are the elements that create or relate to the self-regulated learning processes (Pintrich, 2004; Zimmerman, 1998, 2002). Thus, it is argued that students' engagement in self-regulated learning with a variety of tactics.

The changes in time-based analysis indicate that the use of the ePortfolio system for self-regulated learning was improved. The students understood more about the system and learning tactics, and they used the system for practicing self-regulated learning skills better over time. For instance, the changes explained that the students not only reviewed the feedback, when the time of use increased, they also performed other types of activity, for example, self-evaluation.

4. Conclusions

In this research the relations among ePortfolios, competency, and self-regulated learning were analysed and synthesized. This knowledge played an important role in developing an ePortfolio model for self-regulated learning. From this model, an ePortfolio system was implemented that can handle the issues of fostering self-regulated learning, for example, self-regulated learning principles representation and sharing, or self-regulated learning process implementation. The model and implemented system help us to handle the main issues of fostering self-regulated learning (Winne, 2005; Zimmerman and Tsikalas, 2005). The results of this study suggest that the combination of self-regulated learning, ePortfolios, and competency promotes self-regulated learning. This combination leads to a unified platform, in which students can practice all self-regulated learning activities. In addition, these activities are logged for the assessment or modeling of self-regulated learning.

The MSLQ scores show that there were significant differences between pre-test and post-test scores, and between control and experimental groups. It is reasonable to infer the positive effects of the ePortfolio-based learning model on student-motivated strategies for learning scales. Consequently, the impact of the ePortfolio system on student self-regulated learning was recognized based on the framework for self-regulated learning assessment employed (Pintrich, 20014). In addition, the trace data shows that the students implemented and linked the self-regulated learning processes successfully in the ePortfolio environment. This is a key to developing self-regulated learners (Zimmerman and Tsikalas, 2005). The trace data also indicates that student self-regulated learning skills were improved over time by using the ePortfolio-based learning model.

There were some limitations in this research. The MSLQ surveys were conducted at the beginning and at the end of the semester. Thus, the changes of students' SRL may be due to the passage of time. The lack of time, courses, and students for experiment were other limitations of this study.

For future work, there is a need to conduct more experiments with students from different disciplines and contexts. It is necessary to design and implement evaluation with academic programs. Other types of analysis need to be used to explore ways in which the system affects students' learning and what needs to change in order to improve the impact of the system on students' learning, for example, individual level analyses, and artifact content based analyses.

Acknowledgements

We would like to thank eportfolio group at Hoa Sen University for helping us conduct the experiment.

References

- Abrami, P. C., Wade, C. A., Pillay, V., Aslan, O., Bures, E. M., & Bentley, C. (2008). Encouraging self-regulated learning through electronic portfolios. *Canadian Journal Of Learning And Technology*, 34(3), online version.
- Bartolomé, A., & Steffens, K. (2011). Technologies for self-regulated learning. In R. Carneiro, P. Lefrere, K. Steffens, & J. Underwood, *Self-Regulated Learning in Technology Enhanced Learning Environments* (pp. 21-31). Sense Publishers.
- Cheang, K. I. (2009). Effect of learner-centered teaching on motivation and learning strategies in a third-year pharmacotherapy course. *American Journal of Pharmaceutical Education*, 73(3), Article 42.
- Devolder, A., Braak, J. v., & Tondeur, J. (2012). Supporting self-regulated learning in computer-based learning environments: Systematic review of effects of scaffolding in the domain of science education. *Journal of Computer Assisted Learning*, 28(6), 557-573.
- Gadbury-Amyot, C. C., Kim, J., Palm, R. L., Mills, G. E., Noble, E., & Overman, P. R. (2003). Validity and reliability of portfolio assessment of competency in a baccalaureate dental hygiene program. *Journal of Dental Education*, 67(9), 991-1002.
- Hadwin, A. F., Oshige, M., Gress, C. L., & Winne, P. H. (2010). Innovative ways for using gStudy to orchestrate and research social aspects of self-regulated learning. *Computers in Human Behavior*, 26(5), 794-805.
- JISC. (2008). *Effective practice with e-Portfolios: Supporting 21st century learning*. Bristol, UK: JISC Innovation Group.
- Perry, N., & Winne, P. (2013). Keys to promoting self-regulated learning. *Teacher Newsmagazine*, 25(5). Retrieved from <http://bctf.ca/publications/NewsmagArticle.aspx?id=29340>
- Pintrich, P. R. (2004). A conceptual framework for assessing motivation and self-regulated learning in college students. *Educational Psychology Review*, 16(4), 385-407.
- Rao, S., Swartz, A., Obeid, L., Rao, S., Joyce, B., Whitehouse, S., . . . Shepard, A. (2012). e-Portfolio competency metadata: Pilot study for a call to action. *Journal of Medical Systems*, 36(2), 457-462.
- Ryan, M., & Ryan, M. (2012). A model for embedding reflective learning in eportfolios in higher education. *the 10th international eportfolio and identity conference ePIC 2012* (pp. 198-202). London, UK: ADPIOS, Poitiers, France.
- Steffens, K. (2001). Self-regulation and computer based learning. *Anuarion de Psicología*, 32(2), 77-94.
- Vockell, E. (2008). *Educational psychology: A practical approach*. Retrieved July 2013, from <http://education.purduecal.edu/Vockell/EdPsyBook/>
- Voorhees, R. A. (2001). Competency-based learning models: A necessary future. *New Directions for Institutional Research*, 2001(110), 5-13.
- Winne, P. H. (2005). A perspective on state-of-the-art research on self-regulated learning. *Instructional Science*, 33(5-6), 559-565.
- Winne, P. H. (2005). Key issues in modeling and applying research on self-regulated learning. *Applied psychology: An international review*, 54(2), 232-238.
- Winne, P. H. (2010). Bootstrapping learner's self-regulated learning. *Psychological Test and Assessment Modeling*, 52(4), 472-490.
- Wolters, C. A. (2010, May). Self-Regulated learning and the 21st century competencies. Retrieved from http://www.hewlett.org/uploads/Self_Regulated_Learning__21st_Century_Competencies.pdf
- Zawacki-Richter, O., & Hanft, A. (2011). Validation of competencies in e-portfolios: A qualitative analysis. *The international Review of Research in Open and Distance Learning*, 12(1), 1-9.
- Zimmerman, B. J. (1990). Self-regulated learning and academic achievement: An overview. *Educational Psychologist*, 25(1), 3-17.
- Zimmerman, B. J. (1998). Developing self-fulfilling cycles of academic regulation: an analysis of exemplary instructional models. In D. H. Schunk, & B. J. Zimmerman, *Self-regulated learning From teaching to self-reflective practice* (pp. 1-19). New York: The Guilford Press.
- Zimmerman, B. J. (2002). Becoming a self-regulated learner: An overview. *Theory Into Practice*, 41(2), 65-70.
- Zimmerman, B. J. (2008). Investigating self-regulation and motivation: Historical background, methodological developments, and future prospects. *American Educational Research Journal*, 45(1), 166-183.
- Zimmerman, B. J., & Tsikalas, K. E. (2005). Can computer-based learning environments (CBLEs) be used as self-regulatory tools to enhance learning? *Educational Psychologist*, 40(4), 267-271.

Application of GIS: A New Tool to Explore the Administration and Life of the Local Officers of Tang-Song Dynasty

Hsin-Chun Liu^a, Pei-Lun Lee^{a,*} and Min-Lan Fan^b

^a General Education Center, National Chiayi University, Chiayi, Taiwan, ROC

^b Department of History and Geography, National Chiayi University, Chiayi, Taiwan, ROC

*e-mail: peilun@mail.ncyu.edu.tw

Abstract: We propose to understand the general status of civilian society dated back to the Tang-Sung Dynasty on the basis of the interaction between officers and civilians through detailed exploration of local administrative affairs of Tang-Song Dynasty. Since history records the activity of people, we also attempt to study the life styles of the literati and officialdom of Tang-Song Dynasty. The true and fake images of the so called “civilian’s parents”, judging from the task, practice and social life of local officers are depicted in order to understand more about the relationship between intellectuals and normal people. Thus describes the vivid and vigorous history of the Tang-Song Dynasty. Geographic Information System (GIS) technology will be applied in this study. The life span and career of local officers of the Tang-Song Dynasty are used as main source of information. It will be processed and integrated through high-tech skill and research and provide the viewers with a new vision of analytical method in historic document. In order to analysis the life of local officers, the bulk of historical sources, such as epitaph, judgment, biography and CBDB, will be served as the historical GIS databases. The GIS database will contain the spatial data including modern and ancient maps, satellite images, natural environments, and artificial scenery, special event, communications network, natural disasters, difference between town and country and conflicting events between populace groups that took place during the Tang-Song Dynasty.

Key words: Tang-Song Dynasty, local officers, court verdicts, epitaph, criminal prosecution, census record

1. Introduction

This research is based on the historical sources of commemorative shrines and steles and then to further examine the dynamic states of inspecting achievement system, understanding the possibility of communication between the central and the local. The main points are two: first, to analyze and discuss the process of how the central power legislated the communication medium between the central and the local. In other words, to look at the relationship between official authorities and local powers from the view of issuing, applying for, and observing the verified cases of commemorative shrines and steles-erecting. Second, by understanding how central power controlled individual official and how to establish models as good local officials, we can discuss the practices of Tang laws.

In addition, the records of commemorative shrine and stele in the Song Dynasty (960-1278) indicate the mutual influence between administration law and practice of Confucianism. According to Confucian officials’ legal principle in the Song Dynasty, the regulations of commemorative shrine must be subordinate to the law of commemorative stele. Though building shrine for virtuous government gradually lost its joint function with inspecting achievements system as it did in the Tang Dynasty, the vocabulary used in the records reflected how government officials held responsibility and self-disciplined attitude in

the Song Dynasty, and the process of building stele demonstrated local official's principle when enforcing the law and their strategy to adhering to the law.

2. Research Methods and Procedures

Mapinfo11.5 was used as the software in this study. This article starts with the law in the Administrative Regulations in Book 11 of Tang Legal Code (section on professional regulations) and the Song epitaphs monument pass, a comprehensive review of the local officials of the executive and life in the Song Dynasty. By systemizing those cases of erections of commemorative shrines and steles in the Tang-Song Dynasty and analyzing the time, space, the official positions, and legitimacy of approaches, we can reconstruct the practice of "inspecting achievements" system in the Tang-Song Dynasty.

After the start of the execution plan, first read the fine historical and extant laws Tang and Song unearthed documents, the tomb biography novels, especially dealing with cases where the nature and significance analysis of the career structure Act. From a variety of case classes, compared to normative decrees, in-depth understanding of the principles of a final attempt to analyze the local government office of the trial, the verdict and the Words, observe traditional Chinese official, officials, civil and other duties, changes in living areas.

3. results

From the 114 cases of Tang Dynasty and 384 cases of Song Dynasty studies of commemorative shrines and steles approved by local officials show that the amount of shrine-erecting cases makes not much difference in the former and latter periods of the Tang Dynasty. Looking at the amount of shrine-erecting cases during each emperor's reign, we can see that the number of shrines for virtuous government increased after Emperor Gaozong and reached its peak during the reign of Emperor Xuanzong and Dezong. To look at the location for shrines, most of the shrine-erecting events took place in the north, centering around the Chang'an, Luoyang, and the most prosperous zones of downstream Huanghe River and Huai River; Wei Zhou is a special case. In the south part, most of the shrines were found in Xiang Yang and Yanzhou, which both were important cities at that time; the special case in the south is Guangzhou. For the official positions, Provincial Governor, Prefect, and Prefectural Magistrate were most easily to be elected to have a commemorative shrine, and then the County Magistrate. In the Late Tang Dynasty, a lot of shrines for virtuous government were erected by Jiedushi (regional military governor). For the approaches of erecting a shrine, more than 60 percent of the cases were legal, which shows the execution procedure and legal efficacy of shrines-erecting. But on the other hand, in the Late Tang Dynasty, the local officials, citizens, and monks of Buddhism and Taoism from border regions usually went to the central government in groups and requested commemorative shrines for the Jiedushi. This can be taken as an evidence of the rising local power and the increasing difficulty in practicing "inspecting achievement" system.

In fact, the central power of the Tang Dynasty reached deep into the localities by making the local officials to "declare the law" and "appreciate the law". By using "inspecting achievement" system, such as "reporting is the first policy" and "the achievement is the most important", the central power created models for officials. And by examining the cases of erecting commemorative shrines and steles, the central power was able to know the government of local officials. The government of local officials was reported from the local to the central, and finally being inscribed on the stone steles.

References

- Brian E. McKnight and James T. C. Liu *The Enlightened Judgment: Ch'ing-ming Chi*. State University of New York Press, Albany.1999.
- Brian E. McKnight · *The Quality of Mercy : Amnesties and Traditional justice*, Honolulu : University Press of Hawaii.

Practical Use of 3D Images in the Interactive Slideshow to Study Traditional Buildings

Soichiro KAWAMURA^{a*} & Hiroyuki SHIMADA^b

^a*Tottori College, Japan*

^b*Faculty of Maritime Sciences, Kobe University, Japan*

*kawamura@ns.cygnus.ac.jp

Abstract: This study developed the educational materials incorporating 3D images viewable with general application software. The material was the interactive PowerPoint slideshow to allow college students to study Japanese traditional buildings and their conservation independently. In the slideshow, students could explore different areas and watch 3D or 2D images with maps and text. Their impressions and watching behavior were documented to evaluate the impact of the slide show. The results indicated the increased availability of 3D images in the slideshow and the improved exploratory behavior of students to 3D images.

Keywords: 3D images, educational materials, interactive slideshow

1. Introduction

With the advances in digital image technology, the availability of stereoscopic 3D images has expanded not only for professional but also for personal use (Michel, 2013). Therefore, 3D images have become an appropriate and accessible medium for education. However, the ease of use of 3D images in education is limited because of the special computer environment required for its presentation. In this study, we propose a simpler way to incorporate 3D images into teaching material using general-purpose software along with 2D images.

Visual presentation of educational material plays roles in enhancing learning, improving comprehension of the content and attracting the learners' interest. 3D teaching materials have also been shown to perform these functions (Carrier, Saira, Rosen et al, 2012; Price & Lee, 2010).

2. Methodology

2.1 Learning objectives

We created Microsoft PowerPoint slides for students to help them learn about Japanese traditional buildings and their conservation. The topic was "Important Preservation Districts for Groups of Traditional Buildings" in Kurayoshi, Japan. This ancient district is preserved since approximately 300 years. The slides in this study are intended for students to explore the visuals in the slideshow and study the traditional buildings voluntarily. Thus, the slideshow is interactive and allows students to move from a slide to any other slide.

2.2 Equipment and Stimulus

The slideshow was displayed on a 27-inch passive 3D monitor (LG Electronics FLATRON D2743P-BN). In this monitor, the horizontal stripes of the film-type filter alternate polarization with each line of resolution and 3D images can be viewed through circularly polarized glasses.

All the images in this slideshow were taken by digital 3D camera (Fujifilm FinePix REAL W3). The each 3D image was adjusted adequately and saved in a row-interlaced format adapted for passive 3D monitors using stereo photo editing software StereoPhoto Maker (SPM). The 2D images were made from the left side of the 3D images. The quality of their images was pre-tested.

2.3 Slides

The materials comprise 43 slides (Figure 1). The first slide explains the general characteristics of the district to learn and the navigation method of the slide show. The second slide shows the whole map of this district divided between east and west; students can move between each location by clicking on the images.

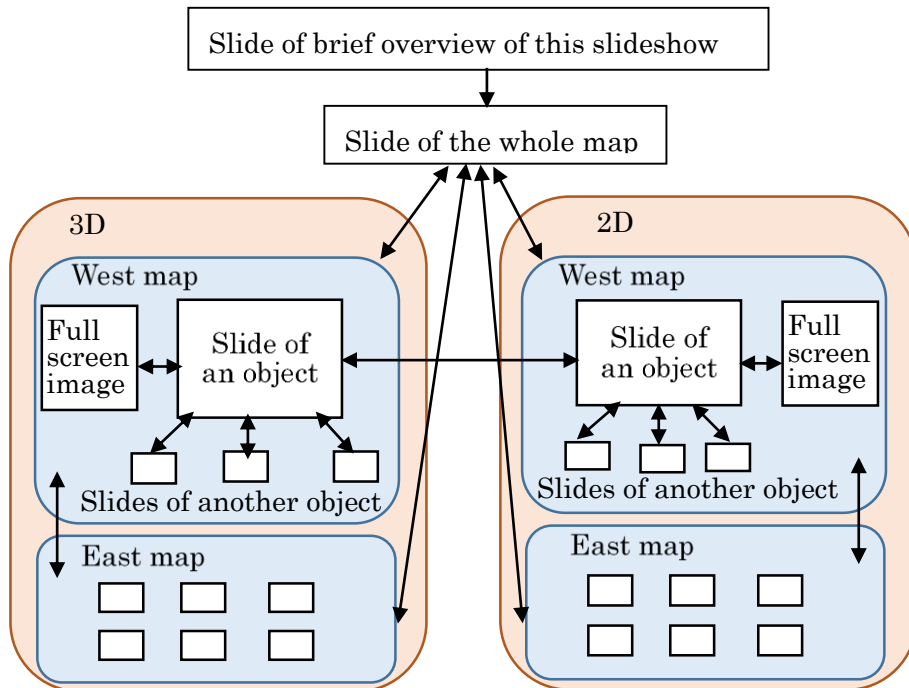

Figure 1. Structure and navigation flow of the slide-show

Description of the below object

玉川沿いは商家の裏側にあたり、外壁の腰回りは杉焼き板、上方は漆喰となっている。それぞれの土蔵の戸口には石橋が架けられている。

写真をクリックすると拡大表示します。

写真の提示次元を変えます。2D<->3D

Image in 3D or 2D

Button for changing the dimension of viewing

Buttons for changing the presentation area

Figure 2. An example of a slide show showing a map, an image, and a description of an object

In the subsequent slides a detailed map containing photo icons appears on the left side. By using PowerPoint's hyperlink function, students can see a slide of an object when they click a photo icon on the map. The maps contain total 10 icons.

On the right side, an image of an object (i.e., a building or street) and its description appear (Figure 2). The image is viewed in 3D or 2D and students can choose the dimension. Their resolution is 800×600 pixels. When students click on the image, it maximizes to full screen size (1920×1080).

3. Evaluation of the slide-show

3.1 Procedure

In order to evaluate the impact of the slideshow in this study, students' impressions and watching behaviors were documented. The participants were 24 college students. Pairs of participants watched the slideshow together without any constraints on slide order or number of viewings. The participants' behaviors were recorded by macro recorder software. After watching the slide show, the participants rated their impression on a 7-point Likert scale.

3.2 Results

The impressions of the slideshow are shown in Figure 3. The ease of viewing images and the operability of the slideshow were determined to be good. The rated attention to 3D images was stronger than that to 2D images.

It was found that the average number of the images watched in full screen was 4.8 in 3D and 1.8 in 2D and that their average viewing time (sec) was 5.1 in 3D and 4.0 in 2D. Thus, exploratory behavior in watching was greater in 3D than 2D. It is likely that participants were more interested in 3D images than 2D.

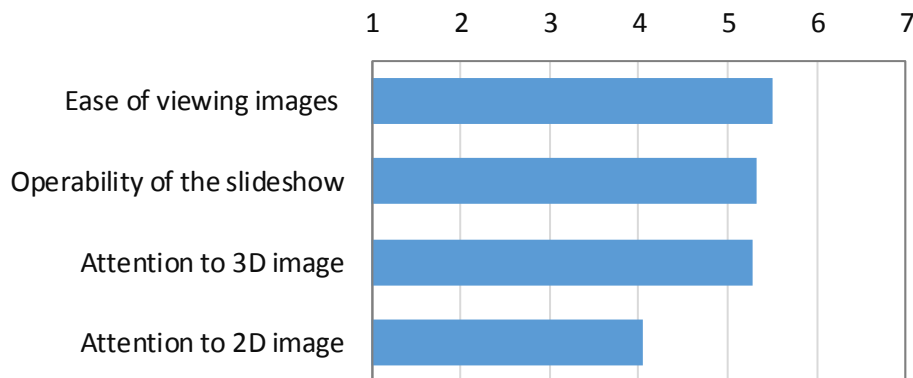

Figure 3. Results of the evaluation of the slide-show

4. Discussion

These evaluation results show that slides combining 3D and 2D images and text in a single display are easy to understand and operate, indicating the increased availability of 3D images used in general presentation software for educational materials. The results also suggest that motivation for learning may be improved by incorporating 3D images into digital teaching materials.

References

- Carrier, L. M., Saira, S. R., Rosen, L. D., Vasquez, L., & Cheever, N. A. (2012). Pathways for learning from 3D technology. *International Journal of Environmental & Science Education*, 7(1), 53-69.
- Price, A. & Lee, H. (2010). The effect of two-dimensional and stereoscopic presentation on middle school students' performance of spatial cognition tasks. *Journal of Science Education and Technology*, 19(1), 90-103.
- StereoPhoto Maker <http://stereo.jpn.org/eng/stphmkr/help/index.htm>
- Michel, B. J. (2013) Digital Stereoscopy: Scene to Screen 3D Production Workflows. CreateSpace Independent Publishing Platform.

The Development of Scenario Game Teaching Material for the Learning of Power Networks at Technology Education in Junior High School

Hiroyuki MURAMATSU^a, Ryoichi KITAZAKI^b, Hiroyoshi NISHIZAWA^a,
Kiyoshi TANAKA^c, Saeed RAMEZANJAMAAT^c and Phillip L. CARDON^d

^aFaculty of Education, Shinshu University, Japan

^bKamata Junior High School, Matsumoto, Japan

^cFaculty of Engineering, Shinshu University, Japan

^dFaculty of Technology Education, Eastern Michigan University, USA

* muramatu@shinshu-u.ac.jp

Abstract: The purpose of this study is to develop the scenario game teaching material for the learning of power networks for the junior high school students. Based on the GBS theory, we developed this teaching material that the games main character is in partnership with the power company to supply power stability in charge area. The result of practices will target the first year students at junior high school, we have been able to verify that this material can be utilized as a teaching tool of power network and attract the interests of students.

Keywords: Scenario game, learning of power networks, GBS theory, junior high school

1. Introduction

The modern society cannot survive without electricity. Learning the power network to support the stable supply of power is an important issue of technology education. In junior high school, subject to learn about the power network and energy technology is in the technology category of the technology and home economics curriculum. Also, this content has been shown in the Course of Study of the technology education (MEXT, 2008). We have already been teaching the materials for the power generating technology and the power consumption, but teaching materials for learning the power network is insufficient. In addition, since there is only a limited time in class, it is difficult also to learn experientially about the power network. So, we thought about the use of scenario game materials in studying simulated real problems. The objective of this study is to develop a scenario game teaching materials for the learning of power networks for the junior high school students.

2. Approach

2.1 Basic design of teaching materials

We were using the GBS theory (Goal-Based Scenario Theory) for the design of scenario game teaching materials. The GBS theory is instructional design theory to design scenario type materials that have been proposed by R.C.SCHANK (1996). In this theory, educators can provide a learning environment in a more realistic context by using the concept of "learn by that failure".

The point of the power network technology is to balance the supply and demand of electricity. Trade-off between environmental load and power generation efficiency and power generation technology may also occur there. Therefore, the students will stabilize the power supply in charge of district employees of the power company. Table 1 shows each element of GBS. In the materials, the objective of this study is to understand the importance of balancing the supply and demand to operate

the power company. We also need to have knowledge of power network and power generation technology.

Table 1: Response to GBS theory of teaching materials

Material elements		Power generation, transmission, distribution and consumption of low cost, high efficiency and stability.
Scenario context	Mission	To supply power generation, transmission, distribution and consumption of low cost, high efficiency and stability.
	Cover story	The games main character is in partnership with the power company.
	Role	Judgment by engineer of the power company.
Goal of learning		Understand the knowledge of power network and power generation technology.
Scenario operation		The power company corresponding to the events that occur in complex.
Scenario	Feedback	Stability to the expected cost, efficiency is indicated by the parameter.
	Source of information	Show the knowledge of power network and power generation technology.

2.2 Development of teaching materials

In order to respond to the restriction of the hardware in home and schools, we have developed a teaching material using the TACS for Flash (Takaaki, 2014, Kojima et al, 2011). For the materials of their choice, we have set the 3 parameters; stability, environmental load, and cost. It was displayed in 5 step parameter (Fig. 1). The numerical values of the 3 parameters were set based on the cost of power generation and CO₂ emissions of each power generation methods. It is described in the technical arts textbook at junior high school and amount of power generated by the Chubu Electric Power Co. Inc in 2013. Also, we have set the event that the demand for power changes for students to allow judgment and selection. (Fig. 2)

For final stage of learning, results are evaluated based on the three-point stability, environmental load, and cost. Then after the awards, students will present a summary of their experience.

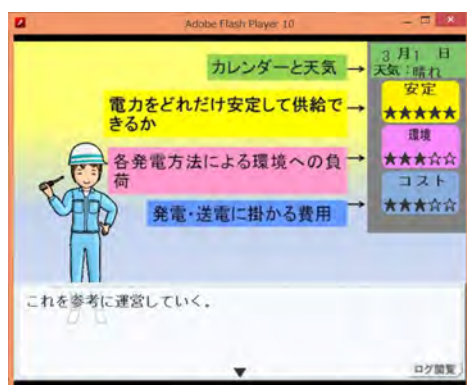

Figure 1. State of the parameters.

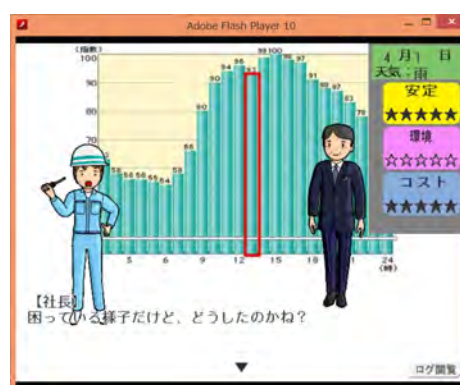

Figure 2. The demand for power changes.

3. Verification of teaching materials

We carried out the teaching materials for 42 first year students at junior high school T (2 class) in prefecture N in December 2013. It was performed in the class of the technical arts and home economics curriculum, class time was 50 minutes. Students do not have the learning of energy in the classroom of the technical arts. The classes used a worksheet with scenario-type game teaching materials. Students

used individual desktop PC.(OS Windows Vista).We have verified the teaching materials, a) Awareness survey of pre-trial and post-trial questionnaire, b) Evaluation of the teaching materials by post-trial questionnaire.

a) Awareness survey of pre-trial and post-trial questionnaire

We have set 13 question items (Table 2).for the knowledge of transmission and distribution results are 3.33 averages, SD1.03. And for the advanced, the result was more of a post significantly higher at the 5% level (3.64 averages, SD0.93)

b) Evaluation of the teaching materials by post-trial questionnaire

For the evaluation of teaching materials, we have set 13 items. For the answers, we categorize to negative answers for checking 1-3 and to positive answer for checking 4-5. For the results of binomial test, it is significantly higher by 5% in 11 items.

Table 2: Item of awareness survey * 4 selection

No.	Item
Q01	I think the work of the power company looks interesting.
Q02	I am interested in the TV programs or the newspaper about power generation.
Q03	I want to know about the various power generation methods.
Q04	I want to know the mechanism of transmission.
Q05	I think that we should have knowledge of the power generating technology.
Q06	I think that we should have knowledge of the power transmission technology.
Q07	I think that we should have knowledge of production and design for energy saving.
Q08	I think that we should have knowledge about the devising of energy saving equipment to be used.
Q09	I think to be aware of the energy saving when I use electrical products and machines.
Q10	I think to try to devise related to energy saving when I make electrical products.
Q11	I think to try to devise increase the effect of energy saving when I use electrical products and machines.
Q12	I think to try to use the function of energy saving in electrical products and machines.
Q13	I think to be aware of the energy saving when I make electrical products.

4. Conclusion

In this study, we aimed to develop the scenario game teaching materials for the learning of power network using the GBS theory for junior high school students. Teaching materials were developed to attract the interests of students. And it can be utilized as a teaching tool of power network. We plan to use in the classroom more often and further improvements will be made in the future.

References

Isei Kojima,other(2011)Development of Educational Material for Scenario Game to let a Junior High Student be Conscious of the Consultation to a Guardian about Nr Trouble, *Japan Journal of Educational Technology*35(Suppl.), 169-172(in Japanese)

MEXT(2008) “Junior High School Course of Study Explanation - Technology and Home Education Chapter” Kyoikutosho pp.23-27(in Japanese)

SCHANK, R. C. (1996)Goal-Based Scenarios, Case-Based Reasoning Meet Learning by Learning by doing. In D Leake (Ed.), Case-Based Reasoning, Experience, Lessons &Future Directions. AAAI Press/The MIT Press

Takaaki(2014) Atelier of C, <http://atelier-c.fiw-web.net/> (2014.1.31) (in Japanese)

The Flipped Classroom: Factors of Self-regulated Learning Affecting Students' Learning Effects

Kuo-Yu LIU*

*Department of Computer Science and Communication Engineering
Providence University, Taichung, Taiwan ROC*

*kyliu@pu.edu.tw

Abstract: This study investigates how students' self-regulated learning affect their learning satisfaction and performance within flipped classroom courses. Eighty-eight undergraduate computer science students taking a flipped classroom course from a private university in the Central Taiwan participated in the study. A Web-based questionnaire was used to collect data on students' demographics, self-regulated learning as well as learning satisfaction and performance. According to the examination of Pearson's correlation coefficients, findings show that the effects of flipped classroom are positive correlated with self-regulated learning of students. In addition, self-regulated learning between students' gender is significant difference in this flipped classroom course as well as learning satisfaction and performance. The effects of flipped classroom are also significant difference between retaking students and other students.

Keywords: flipped classroom, self-regulated learning, learning satisfaction, learning performance, learning effects

1. Introduction

Recent advances in technology and in social network concept bring the evolution of instruction model. Massive Open Online Courses (MOOCs) are a recent development in distance education which began to emerge in 2012. The arrival of MOOCs, which allow hundreds of thousands of students to participate simultaneously in a course, and are free and open to any interested participant, constitute a phenomenon that extends pre-existing initiatives to provide free, educational resources online (Hollands & Tirthali, 2014). Although it is an attractive prospect and rewarding for the teachers to see their work under the sunlight and widely broadcasting all over the world, the potential challenges are that it has much higher dropout rates and lower grades than the conventional kind. A MOOC-like online courses study has been done at Columbia University found that nearly twice as many students dropped out than their counterparts who took the same courses in conventional classrooms. The online students also got lower grades and were less likely to ultimately graduate (Jaggars, Edgecombe & Stacey, 2013). A recent study by researchers investigating the impact of MOOCs also found that few of those who sign up for a course complete it (Ho, et al., 2014). Thus, without a specific class time, students enrolled in MOOCs require enormous focus and self-discipline, and above all, a strong desire to watch lectures and review class materials in a timely manner.

If MOOCs are used as a supplement to classroom teaching rather than being viewed a replacement for it, they can increase instructor leverage, student throughput, student mastery, and student engagement (Fox, 2013). The innovative model is called Small Private Open Online Courses (SPOCs) which supports a current trend in education also known as blended learning or flipped classroom. The flipped classroom is an educational model that consists of two parts: interactive group learning activities inside the classroom, and direct computer-based individual instruction outside the classroom. According to a survey of the literature related to the flipped classroom through June 2012, Bishop and Verleger concluded that despite differences among 24 studies, general reports of student perceptions were relatively consistent. Opinions tended to be positive and students did tend to watch the videos when assigned (Bishop & Verleger, 2013). Another case study focused on the STEM (science, technology, engineering, and mathematics) courses which instructors teach in a flipped classroom also indicated that the impact on student learning is positive (Herreid & Schiller, 2013).

In this study, the instruction model of flipped classroom was deployed on a computer science curriculum, “Operating systems”. This paper focuses on whether students’ self-regulated learning affects their learning satisfaction and performance within flipped classroom after participating in this learning experience. The study population was comprised of students in a private university in the Central Taiwan. The self-regulated learning scale including four factors: self-monitoring and planning (22 items), self-reinforcement and persistence (8 items), self-evaluation and confidence (11 items), and seeking assistance (7 items), is derived from Jen’s research that is more appropriate for Taiwanese students (Jen, 2011). Each item is answered using a four-point scale (strongly agree=4, agree=3, disagree=2, strongly disagree=1). Another 5-point Likert scale used to evaluate the effects of flipped classroom consists of two factors: learning satisfaction (6 items) and learning performance (6 items).

2. Method

2.1 Participants

Students in College of Computing and Informatics must take the course. The participants included 88 students from the following majors: Computer Science and Information Engineering, Computer Science and Communication Engineering, and Computer Science and Information Management. 53% ($N = 47$) of participants were male, and 47% ($N = 41$) were female. 28% ($N = 25$) of participants retake the course, and 72% ($N = 63$) take the course first time. This combination provides a good mix of students to investigate the correlation between different objects and learning effects, in particular to students who retake the course experienced both traditional instruction and flipped classroom.

2.2 Research Methodology

In order to exert the characteristics of flipped classroom, we employed a MOOCs platform as a learning management system. The video lectures and exercises prepared by the instructor were used as out-of-class activities. In the class, small group activities were adopted to complete the discussion of homework assignments and oral presentation. After 10 weeks of the course, a Web-based questionnaire was used to collect data on students’ demographics, self-regulated learning as well as learning satisfaction and performance.

2.3 Research Questions

Here are some interested questions that will be examined in this study:

Q1: Is there any correlation between self-regulated learning and flipped classroom effects?

Q2: Is there significant difference on self-regulated learning and flipped classroom effects between different genders?

Q3: Is there significant difference on self-regulated learning and flipped classroom effects between retaking students and other students?

3. Results and Discussion

Table 1. Intercorrelations of the Factors of self-regulated learning and flipped classroom effects

	Self-regulated learning			
	self-monitoring and planning	self-reinforcement and persistence	self-evaluation and confidence	seeking assistance
Learning satisfaction	.238*	.395**	.149	.183
Learning performance	.312**	.448**	.156	.414**
Flipped classroom effects			.382**	

* $p < .05$; ** $p < .01$

Q1: as Table 1 shows, the effects of flipped classroom indeed correlated with self-regulated learning, and the correlation is significant. The factor, self-evaluation and confidence, has positive correlation but

is not significant indicated that Taiwanese students usually diffident and lack of self-confidence (the result is consistent with Jen's research (Jen, 2011)). The reason may be correlated with the quality of home education in Taiwan.

Table 2. Independent samples *t*-test of different genders

	Gender	N	Mean	Std. Deviation	<i>t</i>	<i>p</i>
Self-regulated learning	Male	47	149.74	14.73	3.783	.000**
	Female	41	138.39	13.21		
Flipped classroom effects	Male	47	45.38	6.71	2.584	.011*
	Female	41	41.61	6.97		

Q2: as shown in Table 2, after examination of independent samples *t*-test, there was a significant difference between male and female students on self-regulated learning ($p = .000 < .05$) as well as effects of flipped classroom ($p = .011 < .05$). The result contradicts Jen's research (Jen, 2011), and the reason may be the course we used in this study was computer science oriented. According to the research results published by Saad et al., there was a significant difference between male and female students who studied science, and female students rated markedly higher than that of male students (Saad, Tek & Baharom, 2009). However, the result in our study is opposite. Therefore, flipped classroom model may play a critical role to enhance students' learning motivation, in particular to male students.

Table 3. Independent samples *t*-test of retaking students

	Retaking Course	N	Mean	Std. Deviation	<i>t</i>	<i>p</i>
Self-regulated learning	Yes	25	147.40	12.94	1.156	.251
	No	63	143.29	15.79		
Flipped classroom effects	Yes	25	46.24	6.96	2.241	.028*
	No	63	42.59	6.87		

Q3: retaking students who experienced both traditional instruction and flipped classroom models could be a typical pointer in this study. The results, as shown in Table 3, indicated that there was a significant difference on effects of flipped classroom. When the dataset was analyzed by retaking students and other students within factors of flipped classroom effects (i.e., learning satisfaction and learning performance), the significance appeared in learning performance ($t = 2.241, p = .028 < .05$). From this finding, we can draw inferences that the flipped classroom will improve students' learning performance to some degree.

References

- Hollands, F. M., & Tirthali, D. (2014). MOOCs: expectations and reality. Full report. Center for Benefit-Cost Studies of Education, Teachers College, Columbia University, NY. Retrieved from: http://cbcse.org/wordpress/wp-content/uploads/2014/05/MOOCs_Expectations_and_Reality.pdf
- Jaggars, S. S., Edgecombe, N., & Stacey, G. W. (2013). What We Know about Online Course Outcomes. Research Overview. Community College Research Center, Columbia University. Retrieved from: <http://files.eric.ed.gov/fulltext/ED542143.pdf>
- Ho, A. D., Reich, J., Nesterko, S., Seaton, D. T., Mullaney, T., Waldo, J., & Chuang, I. (2014). HarvardX and MITx: The first year of open online courses (HarvardX and MITx Working Paper No. 1). Retrieved from: <http://ssrn.com/abstract=2381263>
- Fox, A. (2013). From MOOCs to SPOCs. *Communications of the ACM*, 56(12), 38-40.
- Bishop, J. L., & Verleger, M. A. (2013). The flipped classroom: A survey of the research. In *ASEE National Conference Proceedings*, Atlanta, GA.
- Herreid, C. F., & Schiller, N. A. (2013). Case studies and the flipped classroom. *Journal of College Science Teaching*, 42(5), 62-66.
- Jen, Y. Y. (2011). The Effects between the Personality and the Self-Regulated Learning of E-learning. Master thesis.
- Saad, M. I. M., Tek, O. E., & Baharom, S. (2009). Self-regulated learning: gender differences in motivation and learning strategies amongst Malaysian science students. In *1st International Conference on Educational Research*.

The impact of A.I. on education – Can a robot get into The University of Tokyo?

Noriko H. ARAI* & Takuya MATSUZAKI

Research Center for Community Knowledge, National Institute of Informatics, Japan

*arai@nii.ac.jp

Abstract: The “Todai Robot Project (Can a robot get into The University of Tokyo?)” was initiated by the National Institute of Informatics in 2011 as an AI grand challenge. The goal of the project was to create an AI system that answered real questions on university entrance examinations consisting of two parts, i.e., multiple-choice style national standardized tests and a written test that included short essays. The tasks naturally required the development of ground-breaking underlying technologies in research areas including natural language processing, image processing, speech recognition, automated theorem proving, computer algebra, and computer simulations. It simultaneously required interdisciplinary research synthesis.

Our software took a (digitalized and annotated version of) mock National Center Test for University Admissions (NCTUA), provided by a prep. school, with more than five thousand students. The results revealed that its abilities were still far below the average scores of entrants to The University of Tokyo. However, it was competent enough to pass the entrance exams of 404 out of 744 private universities in Japan. The rapid rise of new AI technologies may negatively affect the labor market in the short term, and we will need to re-design our education systems that were intended to be optimal for the modern industrial society.

Keywords: artificial intelligence, comparative advantage, labor market, automatization

1. Introduction

The question “Can an AI robot pass university entrance examinations?” would have been considered a bad joke ten years ago. However, the tide is turning. IBM Watson defeated a human champion on the American quiz show, "Jeopardy!" in February 2011 (Ferruci et al., 2012), Siri on smartphones answers many spoken questions like “What is the weather like?”, and the Russian chatter bot Eugene was claimed to have passed the Turing test in 2013. All of these were considered to be impossible dreams when the Fifth Generation Computer Systems Project ended in failure in the early 1990s.

AI armed with machine learning technologies often surprises us by demonstrating its power in classification problems like medical analysis, and in optimization problems like automated car driving. This therefore raises a natural question. How far can a machine approach human intelligence? Will it replace human workers, especially white-collar workers in the near future? What particular kinds of jobs are being threatened? Will there be any economic returns to higher education when AI is smart enough to “learn” better than most of us? Do we have to set different goals for higher education in the age of AI?

Before jumping to any conclusions, we have to carefully study both the possibilities of and limitations with current AI technologies in comparison to human intelligence especially in the skills, knowledge, and expertise that have traditionally believed to have only been acquired through higher education. That was the motivation when we started the Todai Robot Project (“Can a robot get into The University of Tokyo?”) in 2011.

It is of course questionable whether or not university entrance examinations are appropriate to test genuine intelligence; there have always been criticisms that entrance examinations only measure the amount of knowledge and skills in specific fields but not generic skills. However, no one can deny that there is general agreement by the public that we can measure high school students' educational

achievements and developments. These educational attainments are simultaneously known to signal employers of the value of potential employees (Arai, 2013).

University entrance examinations in eastern Asian countries, including Japan, are known to be quite competitive and they cover various skill areas and fields. More than half a million high school graduates take the National Center Test for University Admissions (NCTUA), which is a standardized multiple choice style test, every year, and the top 0.5% students are admitted to The University of Tokyo in Japan. We tried to elucidate in what types of intellectual skills human beings possessed comparative advantages over machines through the Todai Robot Project. It should help us design the education reforms necessary for youth to survive in the AI age.

This paper reports the current status of the Todai Robot Project including the underlying technologies we have developed thus far, and the results we obtained from evaluations. We also discuss problems with the current educational system that need to be addressed to increase human capital in the AI age.

2. Background and Related Work

The possibility of strong or weak AI has been discussed since Turing's monumental paper (Turing, 1950). More than a half-century of research in AI has failed to produce any firm evidence that a symbol-system can manifest human levels of general intelligence. The body of work on this discussion is too broad to be discussed here (see, e.g., Craine 2003 for an overview). We just need to state that no theory has yet succeeded in bridging the gaps between the ambiguous formulation of contextual knowledge in a powerful language (e.g., a natural language and images) or its sounds, which are reproducible and computational representations in a formal language (e.g., a programming language). Crane stated (2003) "however natural it seems in the case of our own language, words do not have their meaning in and of themselves. ... They do not have their meaning 'intrinsically'." These types of research, although philosophically interesting, do not suggest in what particular types of intellectual skills we, as human beings, possess comparative advantages over AI in the labor market.

Much research has recently been done on the impact of computerization on the labor market (Bresnahan, 1999, Brynjolfsson and McAfee, 2011, Frey and Osborne 2013). Frey and Osborne estimated that about 47% of US jobs were being threatened by computerization, and they further provided evidence that wages and educational attainments exhibited a strong negative relationship with an occupation's probability of computerization. Their analysis was based on the modified statistical task model introduced by Autor et al. (2003) that postulated (a) computers were more substitutable for human labor in routine relative to non-routine tasks and (b) a greater intensity of routine inputs increased the marginal productivity of non-routine inputs. However, it is not obvious what kinds of tasks can be determined to be "routine" and "non-routine" since the difficulty of particular types of tasks for AI is not determined by the level of "intelligence". Playing professional-level Shogi (Japanese chess) is apparently more non-routine and requires higher-levels of intelligence than classifying illustrated books, even though the former is much easier than the latter for current state-of-the-art AI.

Several international evaluations and workshops such as the Text REtrieval Conference (TREC)¹, the Cross Language Evaluation Forum (CLEF)², and NII Testbeds and Community for Information access Research (NTCIR)³ have developed varieties of tasks for information retrieval and summarization. Most of them have been designed to evaluate applications for specific functions, and it is impossible to see how well near-term AI is able to perform on more complex tasks.

The Allen Institute for Artificial Intelligence's Project Aristo⁴ shared a similar motivation with us, and set a similar goal to build software that would enable computers to "learn" from textbooks, ask questions, and draw tentative conclusions.

¹ <http://trec.nist.gov/>

² <http://www.clef-initiative.eu/>

³ <http://research.nii.ac.jp/ntcir/index-en.html>

⁴ <http://www.allenai.org/TemplateGeneric.aspx?contentId=8>

3. Typical Questions Asked

The University of Tokyo has adopted a two-stage selection system for its entrance examination: The first stage involves multiple choice style national standardized tests (NCTUA). One must take seven subjects including Mathematics, English as a Second Language (ESL), Japanese, Social Studies, and Natural Science and achieve a high score with an accuracy of ~80% to take the second written stage prepared by The University of Tokyo to test proficiency in four subjects.

3.1 Fill-In-The-Blanks Style Questions/ Factoids

Fill-in-the-blanks and factoids are the most typical styles of questions asked to measure the amount of knowledge in educational testing. Mechanization of these types of question answering tests has been well studied especially over the past two decades along with the rise in Web search technologies and the explosion in the amount of born-digital documents (Ravichandran and Hovy, 2002; Ferruci et al., 2010). The combination of N-gram language models, ranking models for document retrieval, co-occurrence rules, and category filtering explains the process of finding proper keywords for these types of questions in many cases, which was demonstrated in the Jeopardy! Challenge by Watson. There is already a consensus that machines possess absolute advantages over human beings in these types of intelligence.

Figure 1 shows an example of a fill-in-the-blanks style question found in past NCTUA problems. The number of questions falling in these categories is unexpectedly less than 10% of all the problems asked; there is little hope that simple localization of Watson-type factoids will pass university entrance examinations.

Question 9
Choose the most appropriate word for the blank in the following speech.

“You can choose either the train or the bus. If you want to save some time, the train would be better. The [] is a little bit higher, though.”

1. cash
2. fare
3. fine
4. interest

Figure 1. Example of Fill-in-the-blanks Style Question in NCTUA ESL Test

3.2 True/False Questions

More than 75% of problems asked in NCTUA in the field of social studies, such as world history, are categorized as true/false questions. Figure 2 shows an example.

The intelligence required for human beings to answer factoid and non-factoid styles of questions seems to be the same: the amount of knowledge. However, recent research on textual entailment (TE) has been revealing in that these technologies that are effective for factoids cannot be easily applied to non-factoids (references). TE in natural language processing is a directional relation between text fragments. The relation holds whenever the truth of one text fragment follows from another text. For example, the machine has to recognize that sentence t2 follows from sentence t1.

t1: Yasunari Kawabata won the Nobel Prize in Literature for his novel "Snow Country"

t2: Yasunari Kawabata is the writer of "Snow Country"

Determining truth/falseness based on knowledge written in textbooks is well regarded as a combination of search and TE recognition tasks. It should be noted that t1 and t2 in this example have only four words in common. We cannot tell why t2 follows from t1, despite sentences like “Yasunari Kawabata criticized ‘Snow Country’” and “Yasunari Kawabata won the Nobel Prize in Physics for his novel ‘Snow Country’” do not only by using the current search technologies.

In Europe north of the Alps, it was not unusual for (4) farmers and those in the lower classes in cities to find it difficult to make a living through a single occupation. In particular, from the (5)latter half of the 15th century to the latter half of the 16th century, a large number of impoverished peasants and poverty-stricken lower classes emerged, due in part to the effects of population increases, and (6)quite a few of them opted to take the path of becoming a mercenary. The lump sum they were paid when joining up and their wages supported their livelihoods. The Thirty Years' War was a war in which such mercenaries played a major role.

Question 4

From 1-4 below, choose the most appropriate sentence that describes rural areas and cities in regard to the underlined portion (4).

1. In the 11th century, in England, enclosure was carried out for the purpose of sheep farming.
2. In the 12th century, the system of domain economies based on compulsory labor spread through the region east of the Elbe River.
3. Guilds were organized in order to guarantee free competition in production and distribution.
4. The Hanseatic League was led by Lübeck.

Figure 2. Example of True/False Question in NCTUA World History Test

Our research team developed a testbed for TE (Miyao et.al, 2012) that utilized the resources taken from the history problems asked in NCTUA, and organized international evaluation tasks at NTCIR-9 and 10. The results from the evaluations revealed that the best system achieved a correct answer ratio of 57%, which is significantly better than a random choice (four choices), but still far below that of human recognition. There is still a long way to go when noting that not only sentence-by-sentence but also paragraph-by-sentence TE recognition combined with searches is required to answer true/false styles of questions.

3.3 Summarization

Not only NCTUA tests but also the written tests by The University of Tokyo often ask the test takers to summarize given documents from a specific point of view. The summarization problems in Japanese and ESL account for more than 20% at NCTUA, and more than 50% in the written test.

Most state-of-the-art automatic summarization systems produce *extractive summaries* by first extracting important sentences from a (set of) document(s) using surficial clues and then re-arranging the extracted sentences with some modifications to achieve readability of output. This is thus methodologically quite different from an alternative ‘deeper’ approach that is based on precise understanding of the source document and natural language generation (NLG) from an abstract representation of the main content of the source document. Nencova & McKeown (2011) provided a recent survey of the field.

While targeting extractive summaries is apparently a practical choice given current progress in the generic language understanding technology and NLG, it clearly falls short of solving some exam problems that ask for the recognition or generation of summaries that are designed to test the examinee’s true understanding of a text. Our current and future work includes the investigation of students’ behaviors in a summarization task, and the evaluation and enhancement of current automatic summarization technologies.

4. Development of Underlying Technologies - Mathematics as Example

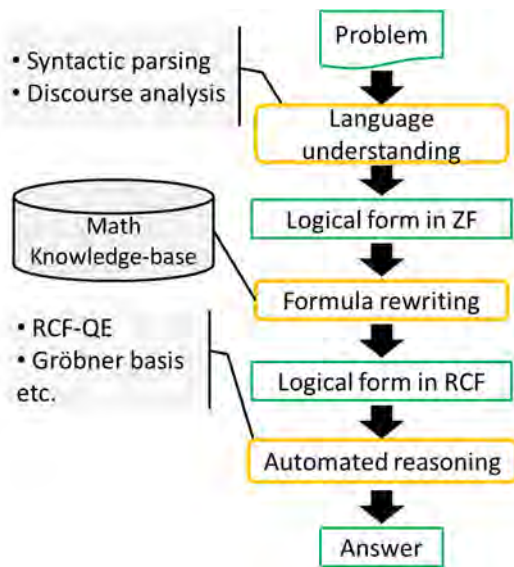

Figure 3. Overview of Math Solver

The current rise of AI has two main origins. The first is, of course, the invention of machine learning. Statistics and optimization deliver their theories to machine learning. The combination of big data and massively parallel computing has enabled machines to “learn” from data existing on the Web, networks, and databases, even though there is only little hope that machine learning technologies will help machines to solve design problems like proving the validity of a given math formula.

The second rather inconspicuous origin is the sophistication of the traditional logical approach. The so-called “knowledge acquisition bottleneck” in the research area of syntactic and semantic parsing of natural language is being relieved by the development of various techniques to extract a massive collection of syntactic/semantic rules from (annotated) text corpora (e.g., Miyao et al., 2004; Hockenmaier & Steedman, 2007; Liang et al., 2011). Similar techniques have also

been developed to extract the inference rules used in high-level reasoning tasks including TE recognition (e.g., Lin & Pantel, 2001; Schoenmackers et al., 2010). The virtue of the logical approach is in its ability to express complex input-output relations, such as the mapping from natural language text to its meaning and the logical relation between a premise and its consequences, in a way that a human can understand.

This raises a natural question. How far can a machine approach human intelligence, particularly in its ability of generic problem solving by mashing up these two different types of AI technologies, statistical and logical? Kanayama and Miyao (2012) presented a technique of converting a true/false question to a set of factoid-style questions, that was aimed at overcoming the difficulty of finding direct evidence for logically rejecting a statement as false in an information source. They achieved an accuracy of 65% on the NCTUA data by employing Watson’s factoid QA engine as the backend system. Tian et al. (2014) developed a semantic representation framework that allowed efficient inference while capturing various aspects of natural language semantics. They combined a logical inference engine based on their semantic representation with a statistical classifier to enhance the coverage of their methodology beyond simple TE recognition problems that could be handled purely within logical inference.

While the design of the semantic representation was in itself a key research issue in Tian et al.’s approach to solving true/false problems in social studies, we already have a well-established system for representing the meaning of mathematical propositions and problems, viz., Zermelo–Fraenkel (ZF) set theory. Thus, the main technical challenges in developing a math problem solver are 1) to accurately translate a natural language math problem into its semantic representation based on ZF set theory, and 2) to mechanically solve a problem expressed as a formula in ZF set theory (Figure 3).

The translation from a natural language text to its formal representation occurs in two steps. The first is the derivation of the meaning of each sentence through syntactic parsing using combinatory categorial grammar (CCG) (Steedman, 2001). The meaning of a sentence is composed in the process of CCG parsing by combining the formal semantic representations of the words in the sentence. The second step is the derivation of the meaning of a problem through the composition of the meanings of the sentences in the problem. We extended the discourse representation structure (DRS) (Kamp and Reyle, 1993) for the theoretical basis of the second step to express the complex inter-sentence semantic composition mechanism that we often encounter in math problems (Matsuzaki et al., 2013).

Table 1: Evaluation results in National Center Test for University Admissions mock tests.

Score	English	Japanese	Japanese History	Math IA	Math IIB	Physics	World History
Task-takers' system	52 (/200)	62 (/150*)	56 (/100)	57 (/100)	41 (/100)	39 (/100)	58 (/100)
Avg. of students	88.3	72.2	45.6	52.0	47.6	42.0	46.6
T-scores of systems	41.0	45.9	56.1	51.9	47.2	48.3	55.2

Table 2: Evaluation results on University of Tokyo entrance exam mock tests (Math).

Score	Math (Humanities course)	Math (Science course)
Test-takers' system	40(/80)	40(/120)
T-scores of systems	59.4	61.2

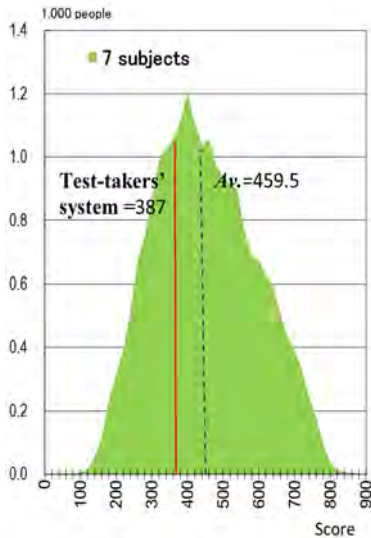

Figure 4. Distribution of total scores in 7 subjects

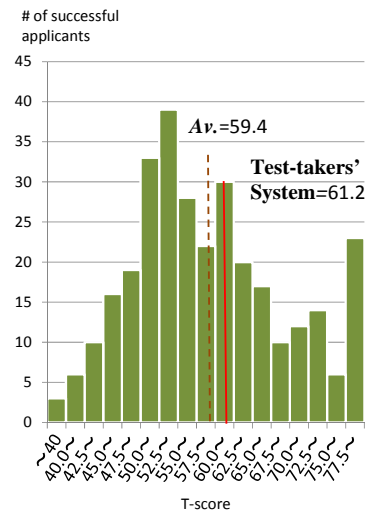
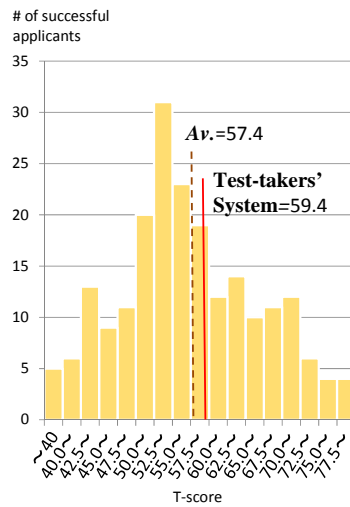

Figure 5. Distribution of T-scores on Univ. Tokyo mock math test achieved by successful applicants in Univ. of Tokyo 2013 exam (Left: Humanities course & Right: Science course)

Even though the language of ZF set theory is powerful enough to express almost all mathematical concepts, no current automatic reasoning technology is capable of making inferences directly based on ZF set theory. We thus need to first rewrite the semantic representation based on ZF set theory into a form that is more amenable to automatic reasoning (AR) such as the theory of real closed fields (RCF) and Presburger Arithmetic. We selected RCF as our first target since elementary geometry and calculus are known to be contained in RCF. However, direct and word-by-word automatic translation often results in very long and redundant formulas beyond the theoretical capacity of an AR algorithm called quantifier elimination for RCF. We succeeded in overcoming many difficulties (Matsuzaki et al., 2014; Iwane et al., 2014) by developing new algorithms. Our empirical study indicated that about half the entrance examination problems expressible in RCF could be solved automatically.

5. Evaluation

We organized an open evaluation task for the NCTUA in 2013. The Yoyogi Seminar, which is one of the major preparatory schools in Japan, provided their mock tests as the source. The fields of the questions included Mathematics (IA and IIB), Physics, World History, Japanese History, Japanese, ESL, and the datasets were provided with human-annotated document structures in XML format (Fujita et al., 2014a). The reason we used mock tests instead of the real tests was that the National Center for

University Entrance Examinations only offers the average scores of the test takers, but not their distributions.

We were able to compare our systems and average senior high school students by administering the mock tests. Table 1 summarizes the results. The average for human test takers was 459.5 out of 900 points. Our systems marked 387, and their T-score was 45.0. Figure 4 plots the status of our systems compared to the human test takers. The capability of our current systems is far below that of the entrants to any of the prestigious universities, including The University of Tokyo. Closer error analysis tells us that our systems made mistakes on problems that required deep reading, situational understanding, world knowledge, common sense, and modeling. Their shallow “literacy” was not good enough to solve these problems. However, our systems did relatively well in some subjects such as world and Japanese histories and mathematics. The Yoyogi Seminar concluded by analyzing the results that our system was capable of passing the entrance exams of 404 out of 744 private universities in Japan.

We evaluated our math problem solving system not only with a multiple choice style test but also with a written test specially designed for those who planned to take the entrance examination of The University of Tokyo. Figure 5 plots the status of our systems compared to the human test takers.

6. Human-Machine Collaboration

Much research has been done on the relation between computerization and recent trends in labor market polarization, with growing employment in high-income cognitive jobs and low-income manual occupations, accompanied by a hollowing-out of middle-income routine jobs (see, e.g., Frey and Osborne 2013 for an overview). As machines get smarter, human beings are expected to become even smarter to be able to survive in the labor market. This trend will be accelerated even more by the emergence of smarter machines. Digital abundance has already decreased the significance of simple memorization and calculation skills, while it has increased that of skills that make use of the new technologies to augment one’s talents and abilities. These skills are sometimes referred as a part of information literacy (AASL/AECT, 1998) and as a part of key competency (Rychen and Salganik, 2003). Public education is expected to play the main role in assisting students to acquire these generic skills that seem to provide a comparative advantage to human beings.

We investigated the factors affecting the problem solving skills of third-year high school students, taking search and editing tasks as an example (Fujita et. al., 2014b). Search technologies are the most typical and powerful AI technologies currently available. It is simultaneously difficult for current machines to determine the truth/falseness of found documents, as was explained earlier in this paper. Students educated for 12 years in schools are expected to be intelligent enough to evaluate the appropriateness of found documents to achieve the goals of searches. We were particularly eager to know whether or not academic histories in specific areas would have positive effects on the accomplishments of tasks.

The participants in our experiment were 70 students from two public high schools. The students had to pass an entrance examination to enroll in the schools and both were considered to be in the top 7% in the prefecture. All the participants were motivated to go on to high ranking universities in Japan.

The participants were provided with an interface where they could edit answer sentences after searching a document, which was a Japanese history textbook. The participants could copy and paste statements derived in search form to answer form and edit them in answer form.

Two problems about Japanese history were asked in the experiment. Both of them had to be answered within 15 minutes. If a participant selected a certain page (correct page) from the document in Problem 1 (P1) and extracted a certain set of consecutive sentences (correct part), he/she could completely answer the problem. Problem 2 (P2) required a slightly more complex cognitive procedure. The participants had to select two particular pages, extract certain consecutive statements from each page, and summarize the statements to meet the requirements. If the participants in P2 only used the exact extracted text from the correct pages as the answer text, they would exceed the word count limitations.

The percentage of criteria participants met was about 70% in P1 (average score was 1.39 and SD = 0.60) and about 48 % in P2 (average score was 3.36 and SD = 1.55). They naturally performed more poorly when more complex cognitive processing was required. Most participants found the

correct pages in P2, but they could not meet nearly half of the criteria. This indicated that participants had trouble unifying and editing information.

Out of the 70 participants, 43 took a class in Japanese history in their second year of high school, while 37 did not. We unexpectedly found that academic history had no significant effects on the number of correct pages selected or the test scores for either problem (Figure 6). These findings suggest that learning in a traditional setting (i.e., the combination of lectures, textbooks, and standardized tests) did not contribute to developing abilities to evaluate the appropriateness of found documents and summarize them properly to meet the requirements.

Further cognitive and pedagogic analysis is necessary to conclude whether or not they would be able to perform better if they had learned in a different setting, such as active learning and computer supported collaborative learning. We left this for future work.

7. Conclusion

We introduced the aims and the state of progress in the “Todai Robot Project”. The purpose of the project was to open up new horizons by reintegrating the subfields of AI that have come about since the 1980s, and encourage researchers in these areas to share progress and findings over the past thirty years. We simultaneously tried to elucidate the abilities of the current AI in comparing it to human students using university entrance examinations as a testbed. It should help us to understand the possibilities of and limitations with near-term AI technologies.

We have thus far developed AI systems that were capable of passing the entrance examinations of more than half the universities in Japan. The progress with our math problem solving system especially suggested that human beings cannot maintain their comparative advantage over machines in problem solving in the most important areas of geometry and calculus. We have to wait for future research to conclude whether or not this will be the same case for TE recognition and information summarization.

We analyzed the performance and the effects of the academic histories of high school students in solving Japanese history problems with a search-and-edit interface. Unfortunately, the results revealed that their academic histories had no significant effects on performance. This suggests that it is necessary to re-design the education system by taking into consideration pressures from the labor market.

Acknowledgements

We would like to express our gratitude to the National Center for University Entrance Examinations, the Yoyogi Seminar, Tokyo Shoseki Co., Ltd and, Yamakawa Shuppansha Ltd. for their support. The Todai Robot Project was financially supported by the National Institute of Informatics.

References

- Anderson, R. E. (1992). Social impacts of computing: Codes of professional ethics. *Social Science Computing Review*, 10(2), 453–469.
- Ferrucci, D. A. (2012). Introduction to “This is Watson”. *IBM Journal of Research and Development*, 56(3.4):1:1–1:15.
- Arai, K. (2013). *The Economics of Education: An Analysis of College-Going Behavior*, Springer-Verlag.
- Turing, A. M. (1950). Computing Machinery and Intelligence. *Mind*, 49, pp. 433–460.
- Crane, T. (2003). *The mechanical mind: A philosophical introduction to minds, machines and mental representation*. Presbyterian Publishing Corp.
- Bresnahan, T.F. (1999). Computerisation and wage dispersion: an analytical reinterpretation. *The Economic Journal*, vol. 109, no. 456, pp. 390–415.
- Brynjolfsson, E. and McAfee, A. (2011). *Race against the machine: How the revolution is accelerating innovation, driving productivity, and irreversibly transforming employment and the economy*. Digital Frontier Press Lexington, MA.
- Frey, C. B. and Osborne, M. A. (2013). *The future of employment: how susceptible are jobs to computerisation?* Oxford University.

- Autor, D., Levy, F., and Murnane, R.J. (2003). The skill content of recent technological change: An empirical exploration. *The Quarterly Journal of Economics*, vol. 118, no. 4, pp. 1279–1333.
- Ravichandran, D. & Hovy, E. (2002, July). Learning surface text patterns for a question answering system. In *Proceedings of the 40th Annual Meeting on Association for Computational Linguistics* (pp. 41–47). Association for Computational Linguistics.
- Ferrucci, D., Brown, E., Chu-Carroll, J., Fan, J., Gondek, D., Kalyanpur, A. A., Lally, A., Murdock, J. W., Nyberg, E., Prager, J., Schlaefer, N., and Welty, C. (2010). Building Watson: An overview of the DeepQA project, *AI magazine*, 31(3), pp. 59–79.
- Neškova, A., & McKeown, K. (2011). Automatic Summarization. *Foundations and Trends in Information Retrieval*, 5, (2–3), 103–233.
- Miyao, Y., Ninomiya, T., & Tsujii, J. (2004). Corpus-oriented grammar development for acquiring a head-driven phrase structure grammar from the Penn treebank. In *Proceedings of the First International Joint Conference on Natural Language Processing*, pp. 684–693.
- Hockenmaier, J. & Steedman, M. (2007). CCGbank: A Corpus of CCG Derivations and Dependency Structures Extracted from the Penn Treebank. *Computational Linguistics*, 33, (3), pp. 355–396.
- Liang, P., Jordan, M. I., & Dan Klein, D. (2011). Learning dependency-based compositional semantics. In *Proceedings of the 49th Annual Meeting of the Association for Computational Linguistics: Human Language Technologies*, pp. 590–599.
- Lin, D. & Pantel, P. (2001). Discovery of inference rules for question answering. *Natural Language Engineering*, 7, (4), pp. 343–360.
- Schoenmackers, S., Etzioni, O., Weld, D. S., & Davis, J. (2010). Learning First-order Horn Clauses from Web Text. In *Proceedings of the 2010 Conference on Empirical Methods in Natural Language Processing*, pp. 1088–1098.
- Tian, R., & Miyao, Y., & Matsuzaki, T. Logical Inference on Dependency-based Compositional Semantics. In *Proceedings of the 52nd Annual Meeting of the Association for Computational Linguistics*, pp. 79–89.
- Kanayama, H., & Miyao, Y., & Prager, J. Answering Yes/No Questions via Question Inversion. In *Proceedings of COLING 2012*, pp. 1377–1392.
- Matsuzaki, T., Iwane, H., Anai, H., & Arai, N. (2013). The Complexity of Math Problems – Linguistic, or Computational? In *Proceedings of the 6th International Joint Conference on Natural Language Processing*, pp. 73–81.
- Matsuzaki, T., Iwane, H., Anai, H., & Arai, N. H. (2014). The Most Uncreative Examinee: A First Step toward Wide Coverage Natural Language Math Problem Solving. In *Proceedings of 28th Conference on Artificial Intelligence*, pp. 1098–1104.
- Iwane, H., Matsuzaki, T., Arai, N., & Anai, H. (2014). Automated Natural Language Geometry Math Problem Solving by Real Quantifier Elimination. In *Proceedings of the 10th International Workshop on Automated Deduction in Geometry*, pp. 75–84.
- Miyao, Y., Shima, H., Kanayama, H., & Mitamura, T. (2012). Evaluating textual entailment recognition for university entrance examinations. *ACM Transactions on Asian Language Information Processing (TALIP)*, 11(4), p. 13.
- Fujita, A., Kameda, A., Kawazoe, A., & Miyao, Y. (2014) Overview of Todai Robot Project and Evaluation Framework of its NLP-based Problem Solving. In *Proceedings of the 9th edition of the Language Resources and Evaluation Conference*, pp. 2590-2597.
- Ryche Rychen, D. S. E., & Salganik, L. H. E. (2003). *Key competencies for a successful life and a well-functioning society*. Hogrefe & Huber Publishers.
- Fujita, A., Suzuki, M., & Arai, N. H. (2014) Cognitive Model of Generic Skill: Cognitive Processes in Search and Editing, In *Proceedings of the 36th annual meeting of the Cognitive Science Society*, pp. 2234-2239.